



TAOGLAS®



Datasheet

450-470MHz UHF Terminal Antenna

Part No:
TI.34.A111

Description

450-470MHz Terminal Antenna SMA Male Straight

Features:

450-470MHz Band Operation
IP67 Waterproof Rated
Low-profile Terminal Antenna
SMA(M) Straight Connector
Dimensions: \varnothing 8.5mm x 50.8mm
RoHS & Reach Compliant

1.	Introduction	2
2.	Specification	3
3.	Antenna Characteristics	4
4.	Radiation Patterns	8
5.	Mechanical Drawing	15
6.	Packaging	16
<hr/>		
	Changelog	13

Taoglas makes no warranties based on the accuracy or completeness of the contents of this document and reserves the right to make changes to specifications and product descriptions at any time without notice. Taoglas reserves all rights to this document and the information contained herein. Reproduction, use or disclosure to third parties without express permission is strictly prohibited.



1. Introduction



The TI.34 is one of a range of super small form factor, lightweight, IP67 rated terminal mount antennas from Taoglas. It is ideal for wireless applications operating on ISM or LoRa bands covering 450-470MHz. Its robust enclosure is engineered to perform in the most challenging of external environments when connecting IoT devices to smart grid and smart monitoring applications.

With its IP67 rating, the TI.34 can withstand dust, dirt, and even complete submersion in water, making it the perfect choice for any IoT application that demands both reliable connectivity and extreme durability. Whether you're connecting sensors for remote agricultural, monitoring equipment in industrial settings, or building the infrastructure for smart cities, the TI.34 is a great solution.

If you are looking for an antenna that's small, tough, and versatile, look no further than the TI.34. Contact your regional Taoglas Customer Services Team for more information or to discuss your project.

2. Specification

LTE Electrical								
Band		Efficiency (%)	Average Gain (dB)	Peak Gain (dBi)	Impedance	Polarization	Radiation Pattern	Max. Input Power
UHF 450-470MHz	On 15x9cm Ground plane (Long side)	28.8	-5.40	2.58	50 Ω	Linear	Omni	10W
	On 9x15cm Ground plane (Short side)	38.5	-4.15	3.96				

5G/4G Bands				
Band Number	5G NR / FR1 / LTE / LTE-Advanced / WCDMA / HSPA / HSPA+ / TD-SCDMA			
	Uplink	Downlink	ON 15x9cm Ground Plane	ON 9x15cm Ground Plane
UHF	450 to 470		✓	✓

Mechanical	
Dimensions	ø8.5mm x 50.8mm
Weight	6.9g
Material	TPEE
Connector	SMA(M)

Environmental	
Operating Temperature	-40°C ~ +85°C
Waterproof Rating	IP67

3. Antenna Characteristics

3.1 Test Setup

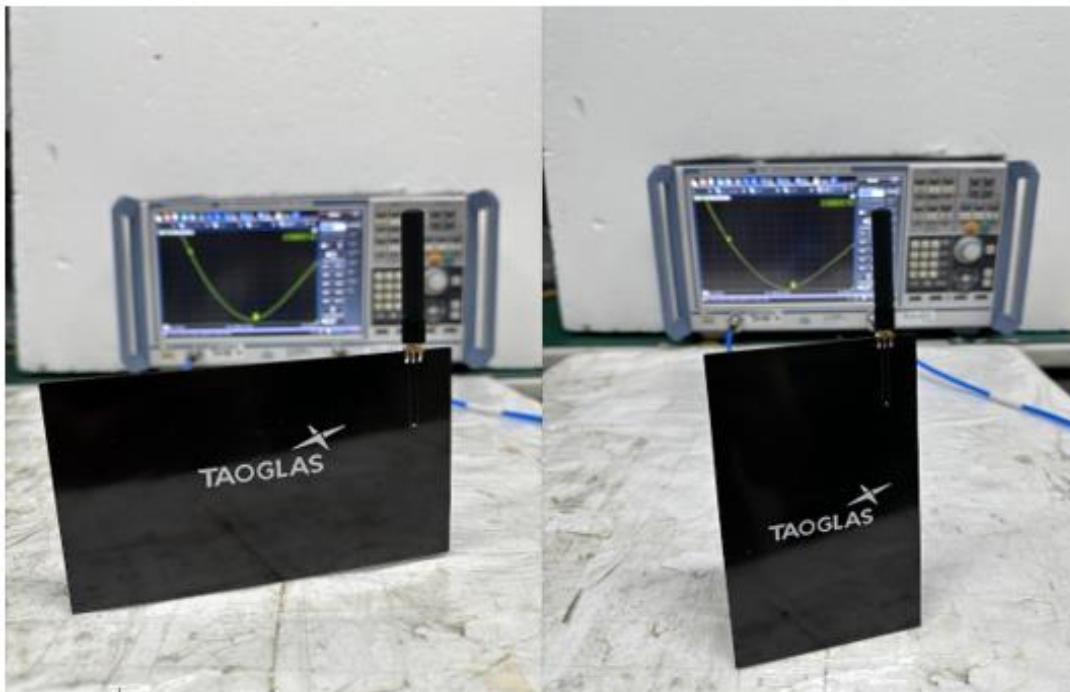
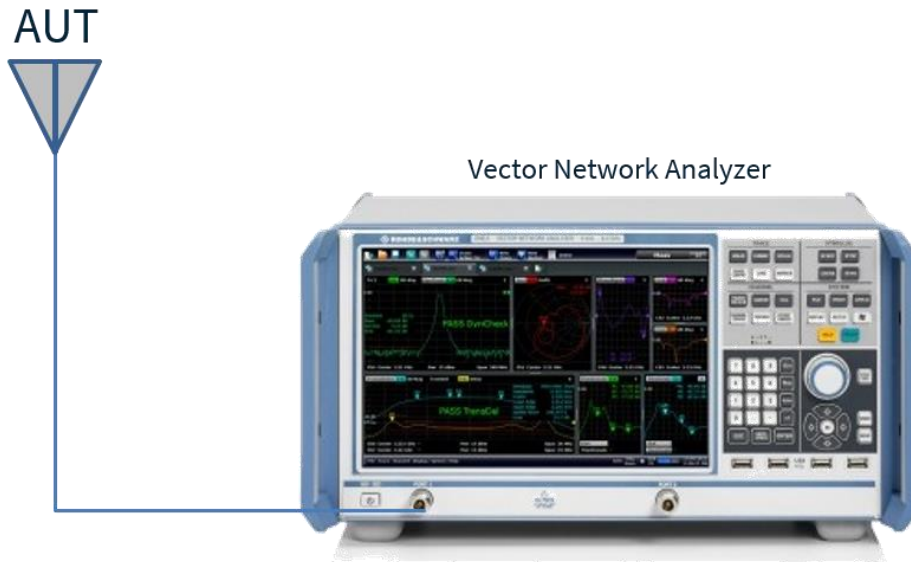

On 15x9cm Ground plane

On 9x15cm Ground plane

3.2 Return Loss

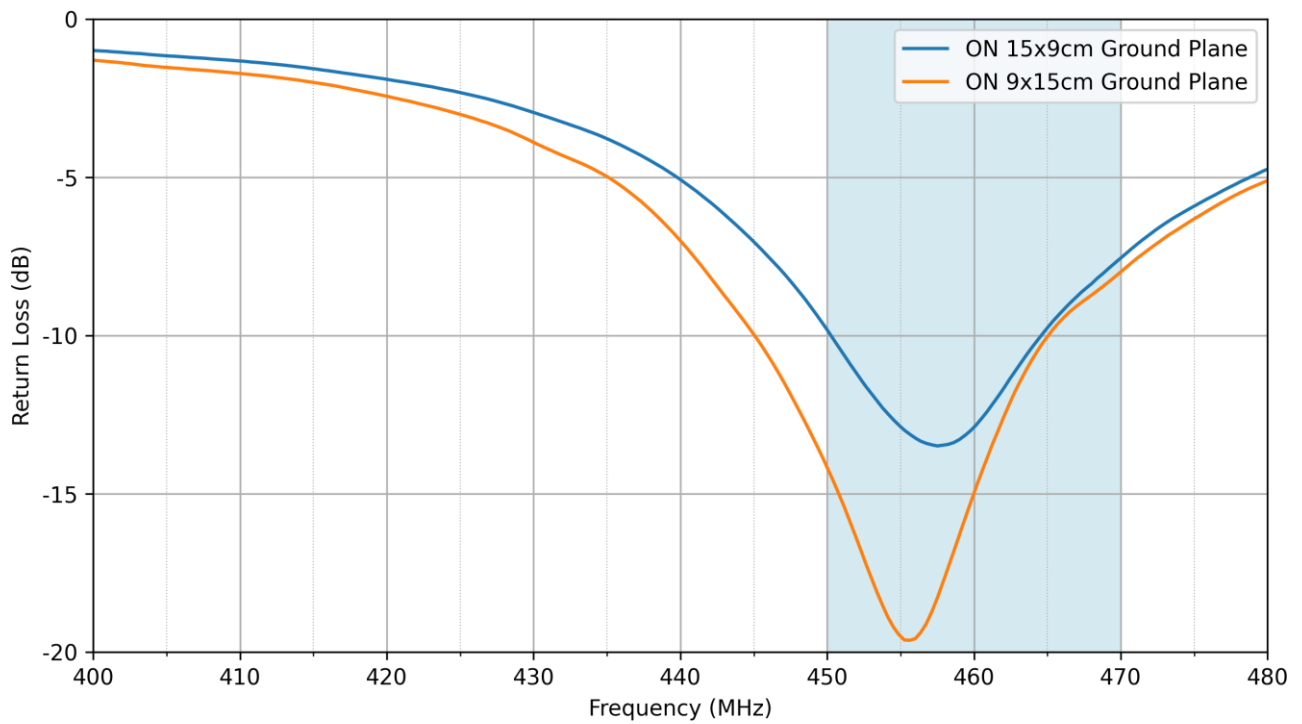

3.3 VSWR

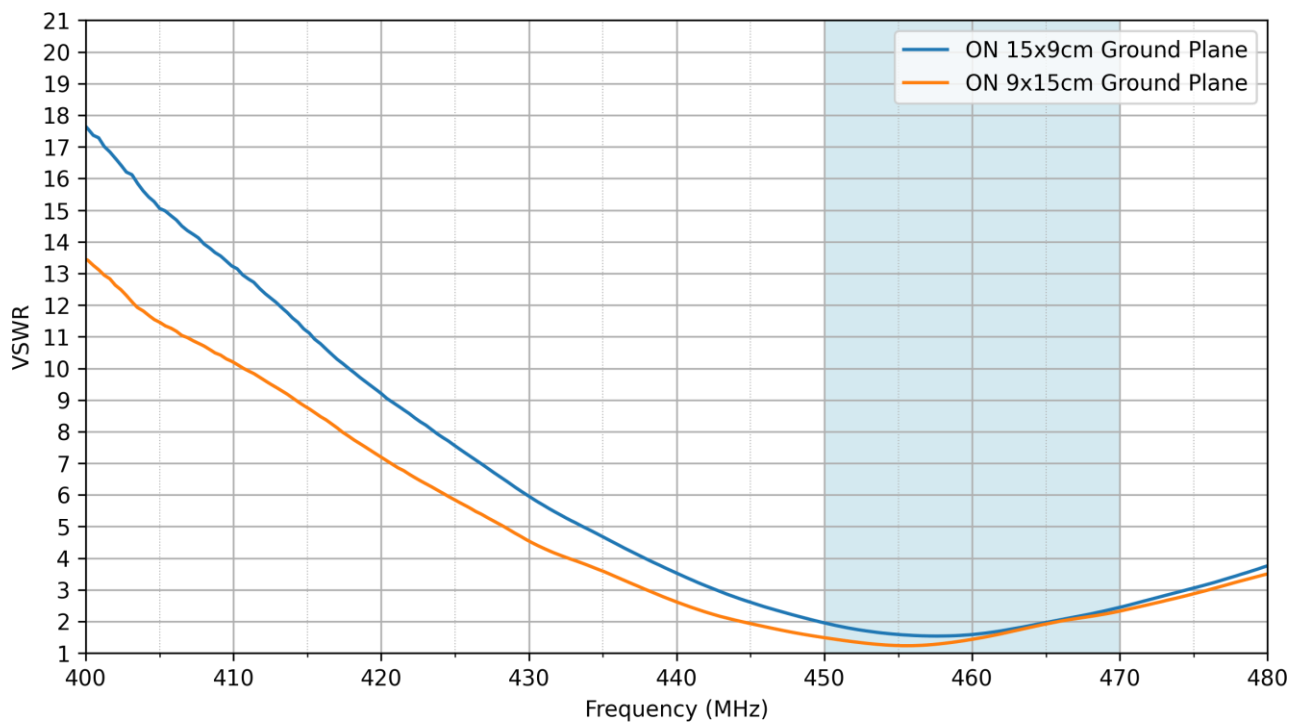

3.4 Efficiency

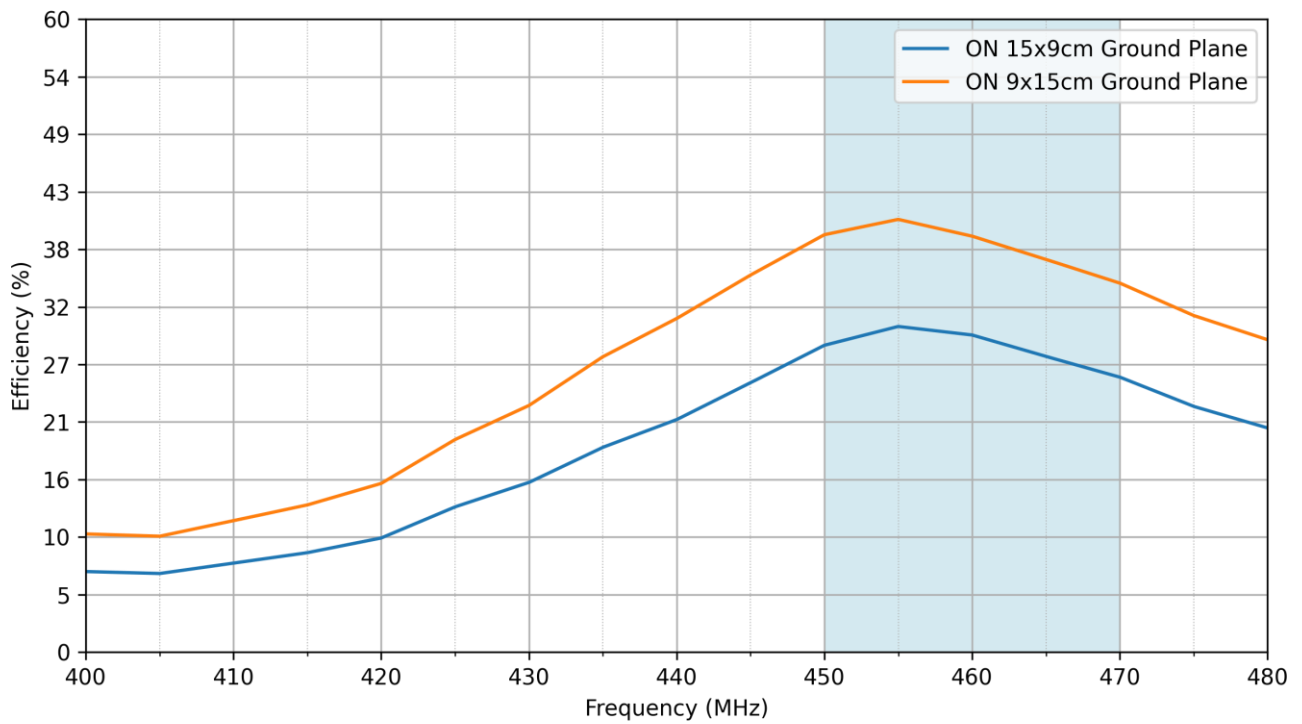

3.5 Average Gain

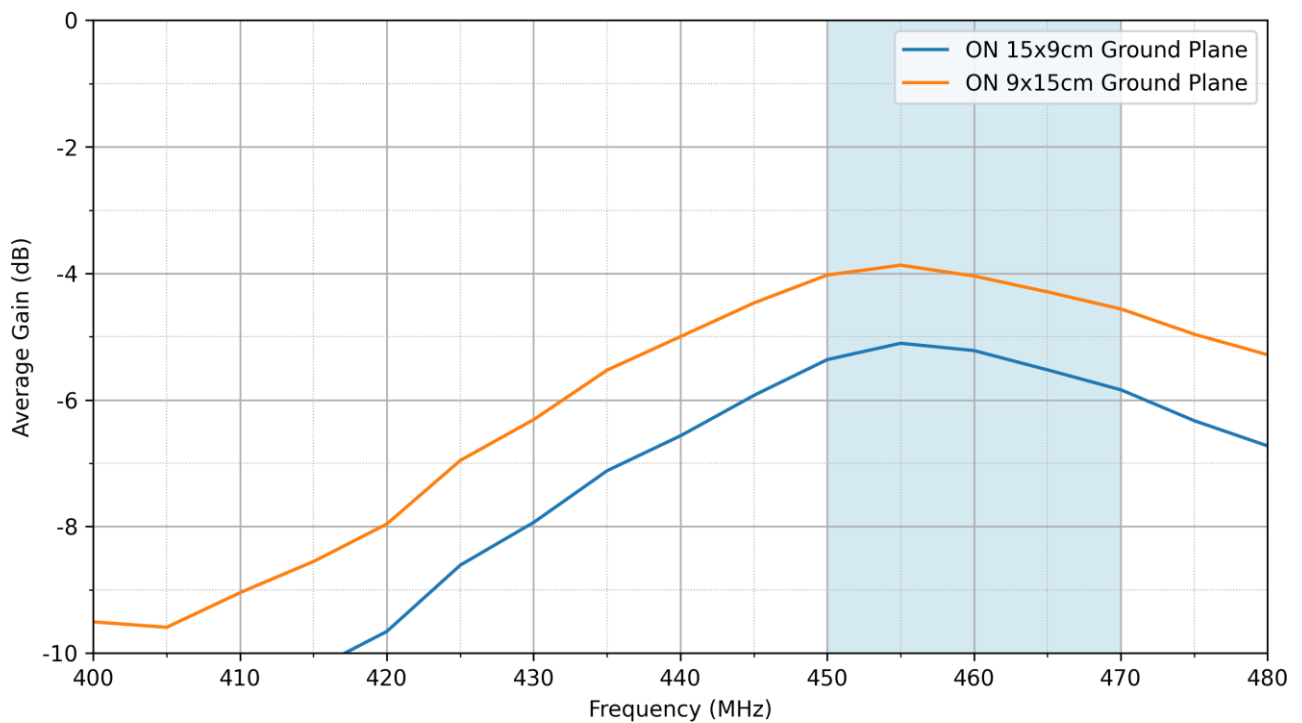

3.6 Peak Gain

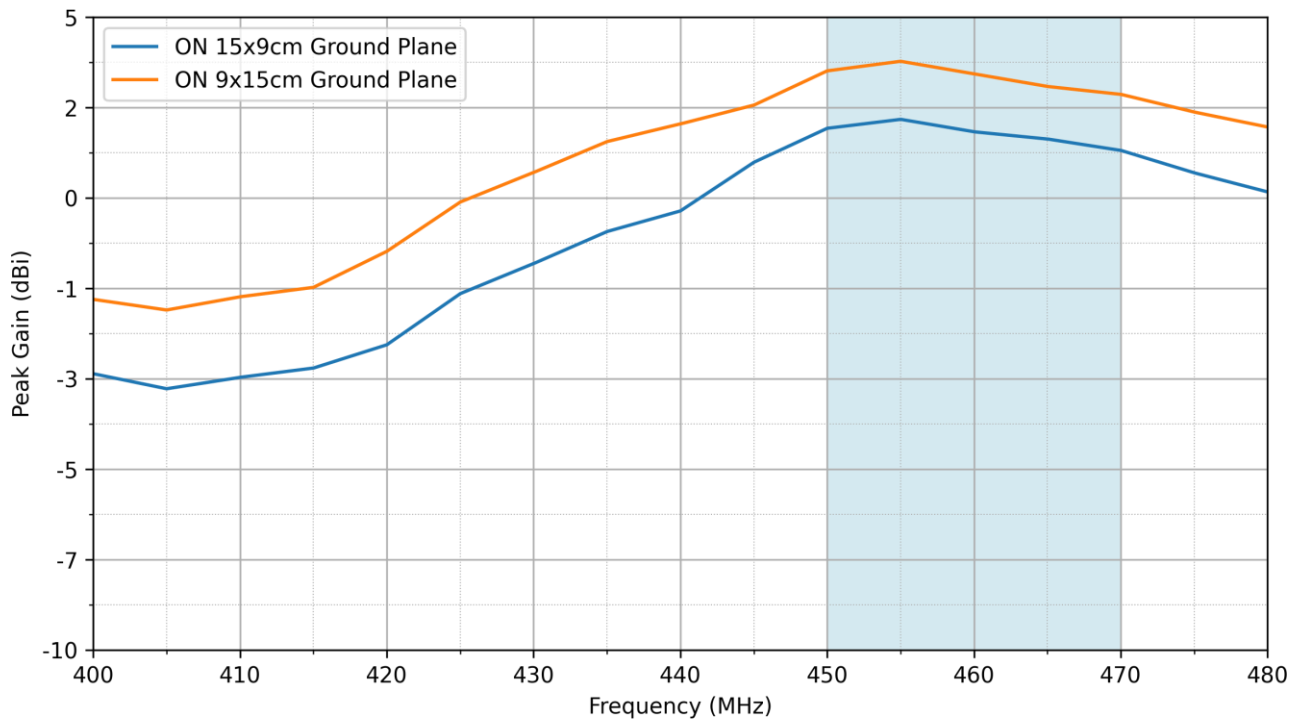

4. Radiation Patterns

4.1 Test Setup

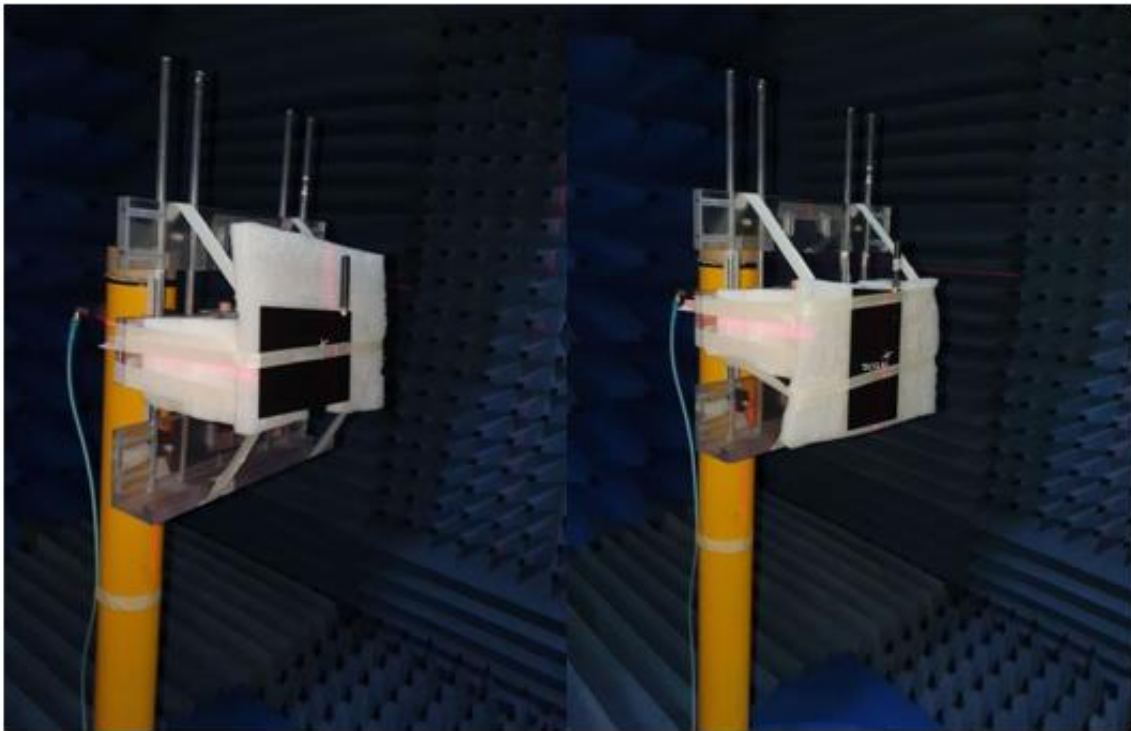
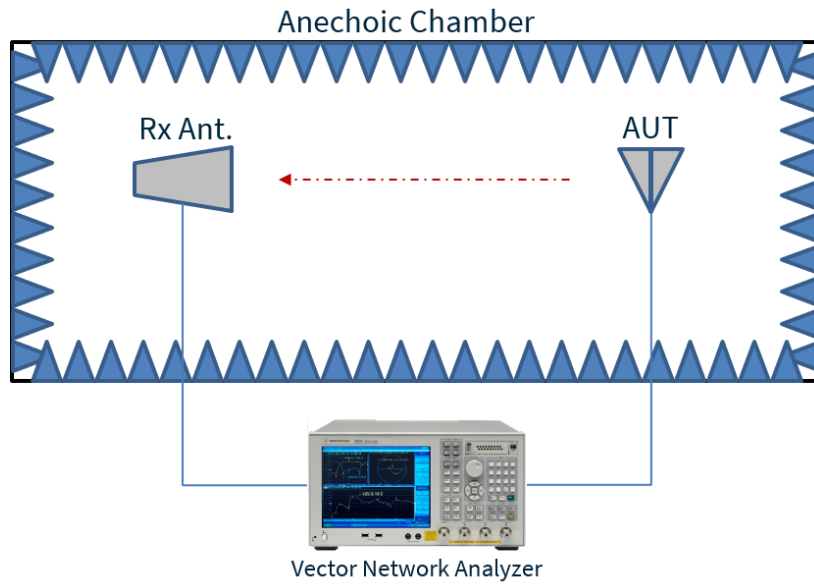

On 15x9cm Ground plane

On 9x15cm Ground plane

4.2 TI.34.A111 - Patterns at 450 MHz on 15x9cm ground plane

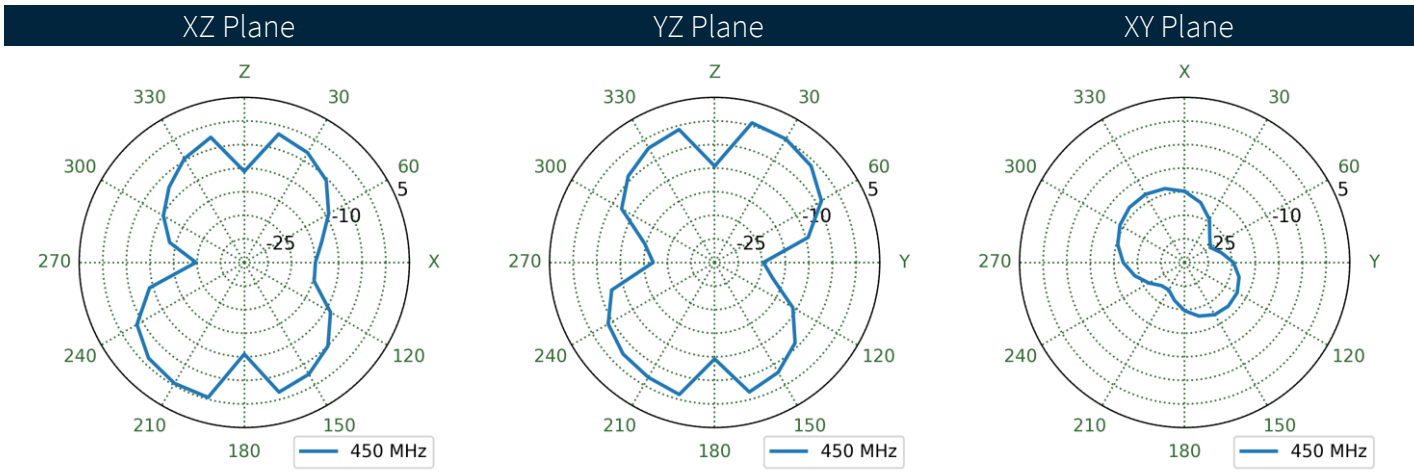
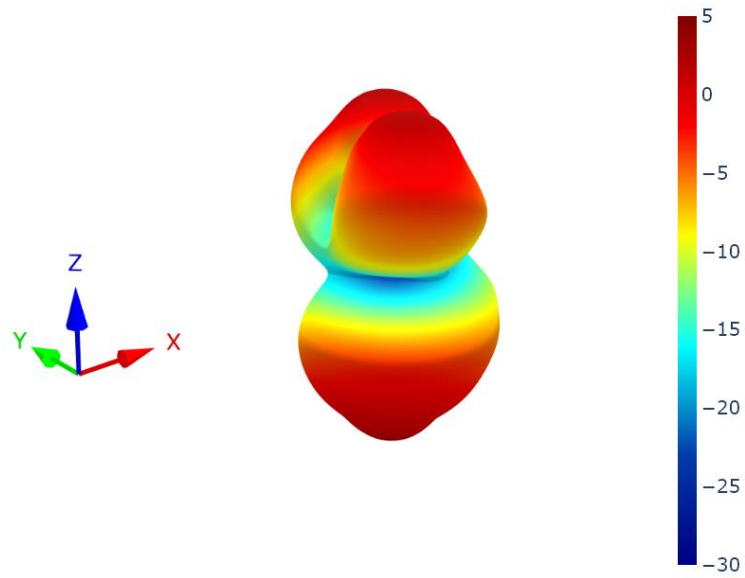

4.3 TI.34.A111- Patterns at 450 MHz on 9x15cm ground plane

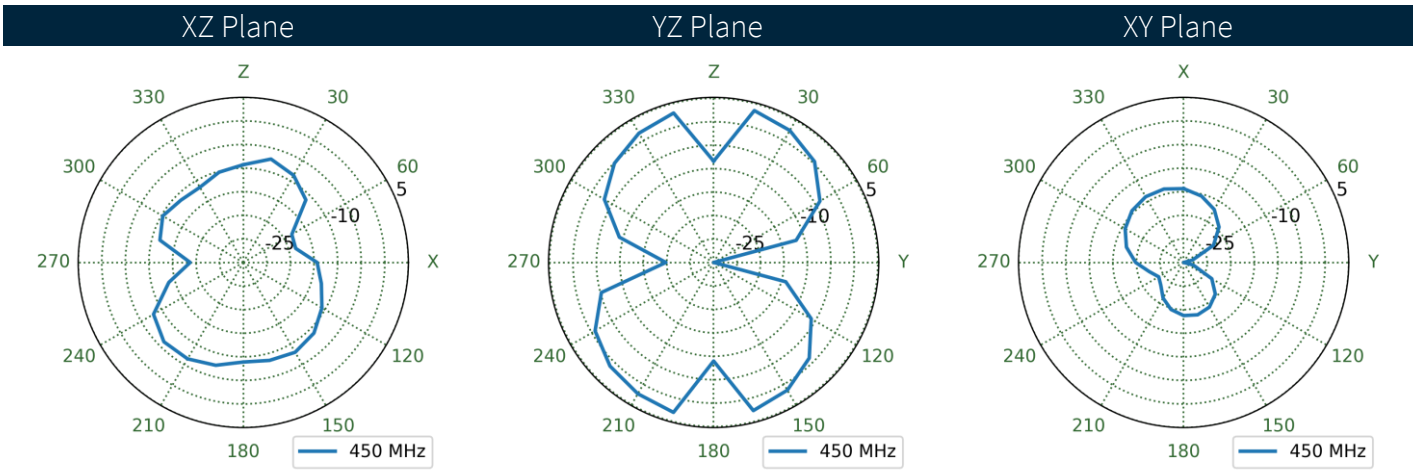
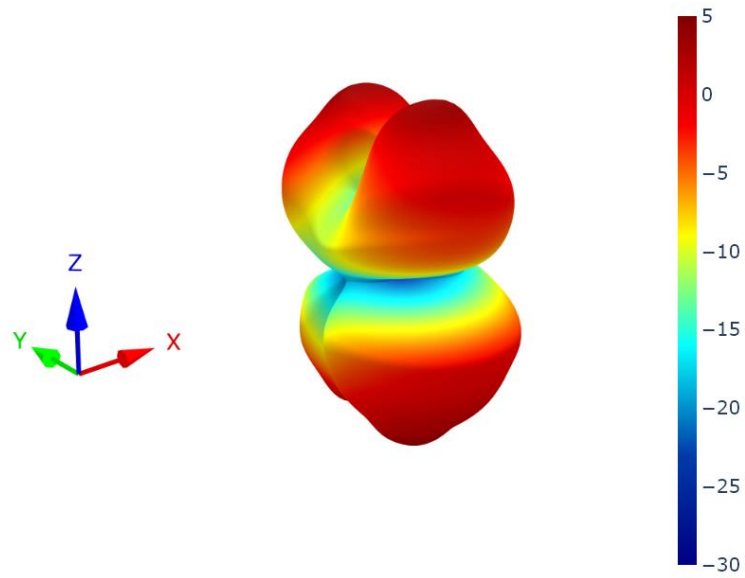

4.4 TI.34.A111- Patterns at 460 MHz on 15x9cm ground plane

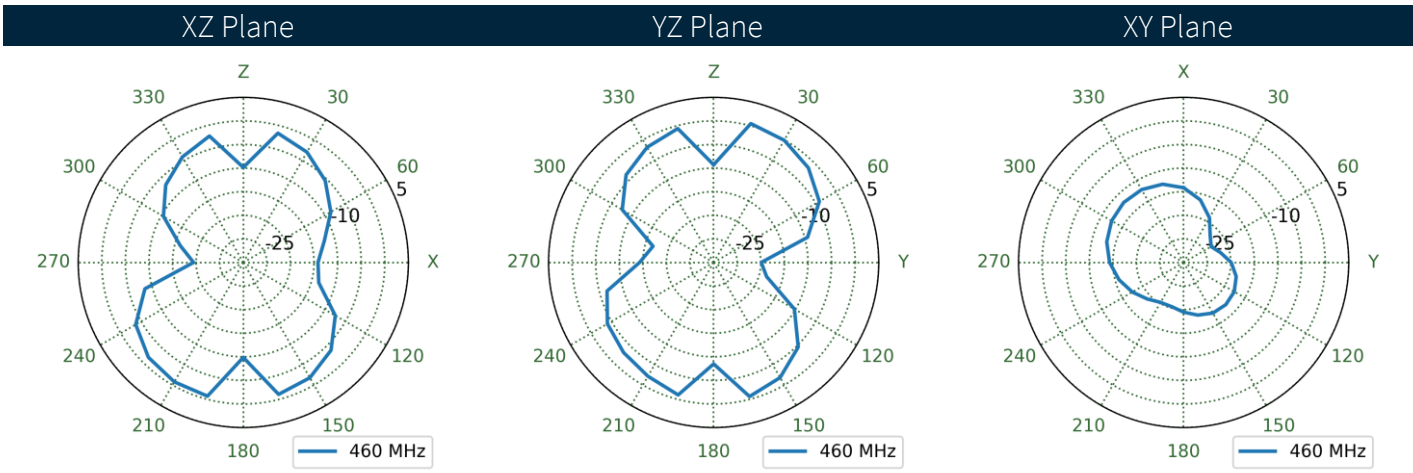
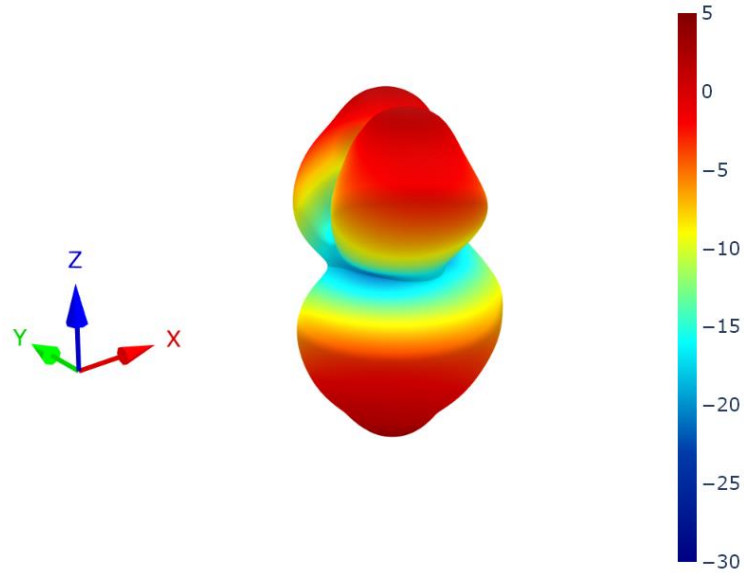

4.5 TI.34.A111- Patterns at 460 MHz on 9x15cm ground plane

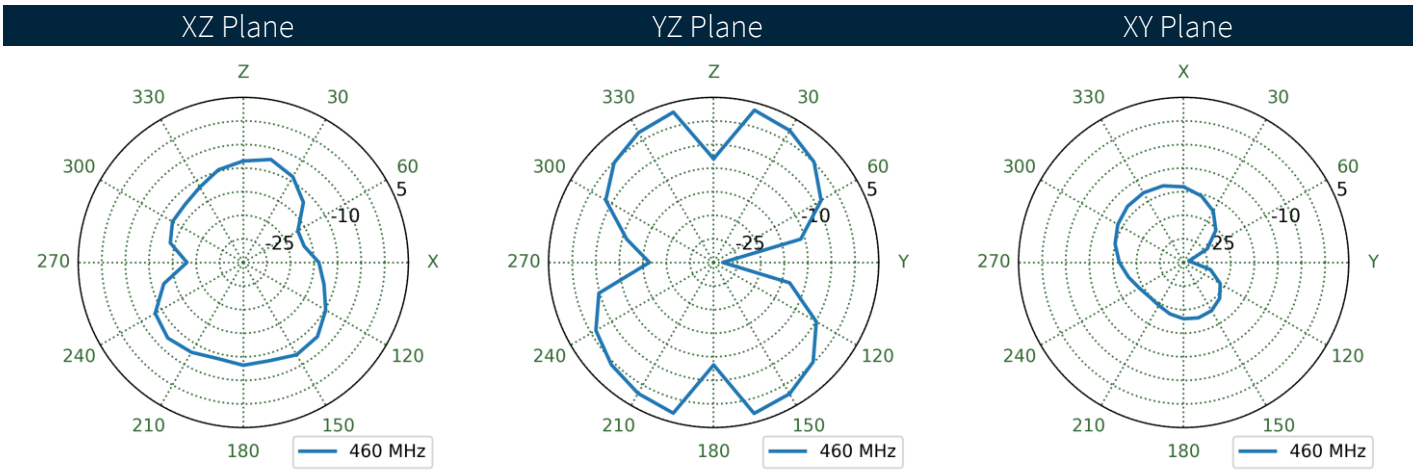
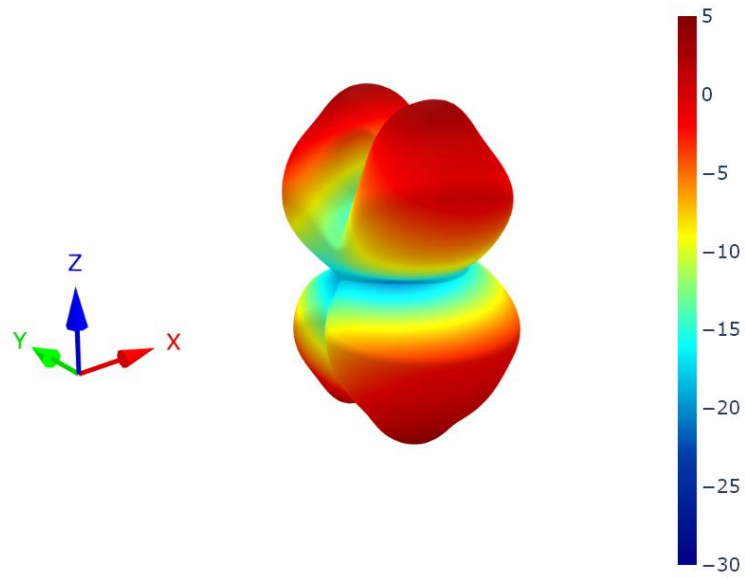

4.6 TI.34.A111- Patterns at 470 MHz on 15x9cm ground plane

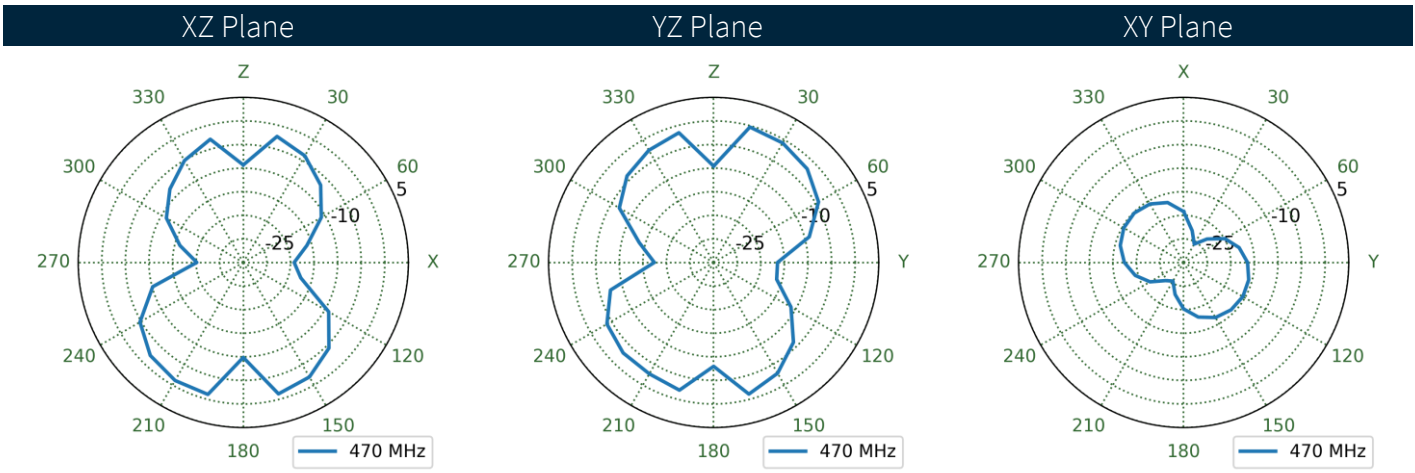
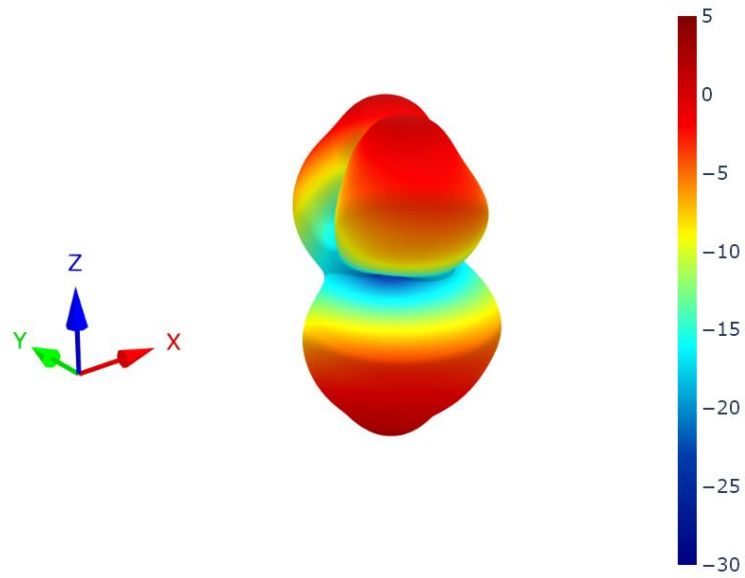

4.7 TI.34.A111- Patterns at 470 MHz on 9x15cm ground plane

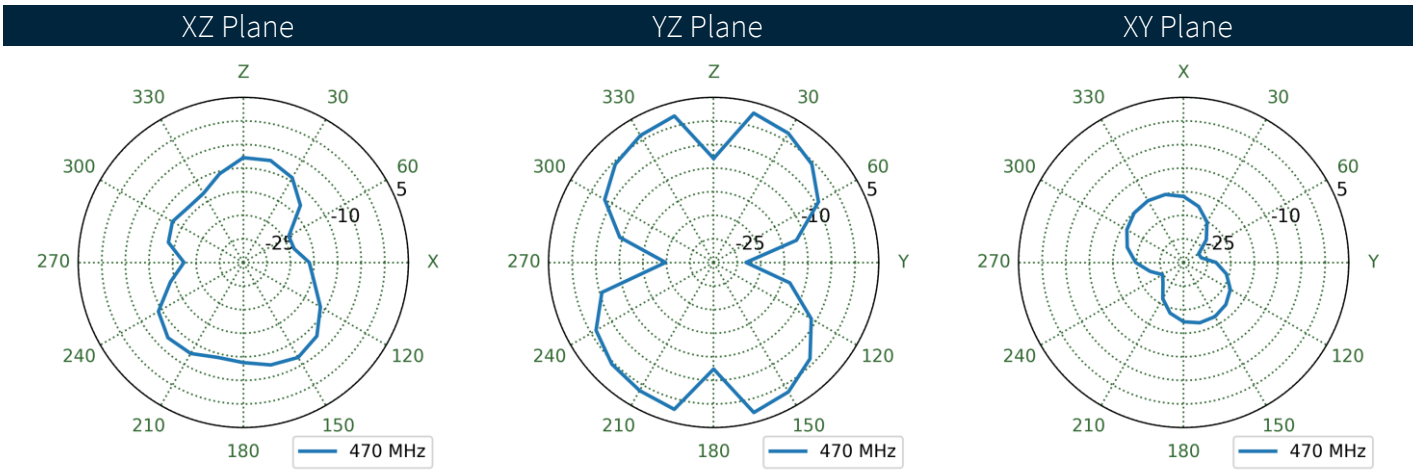
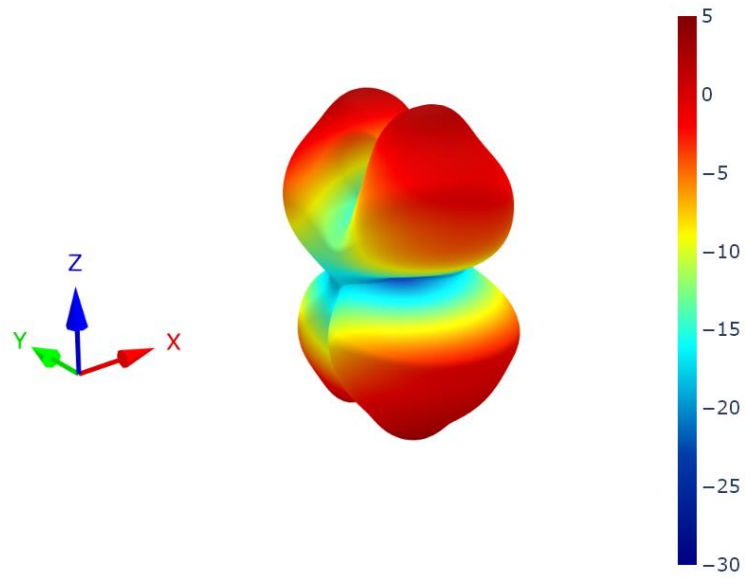

5. Mechanical Drawing

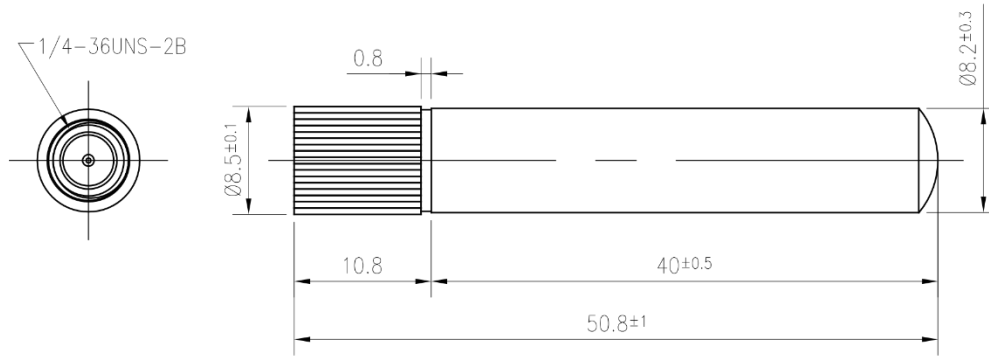

6. Packaging

60pcs TI.34.A111 per Tray
 Weight: 0.5Kg

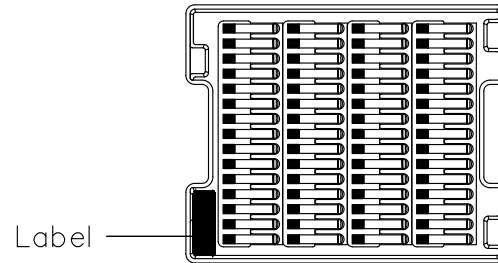

1200pcs per Carton
 Dimensions: 328x296x282mm
 Weight: 10Kg

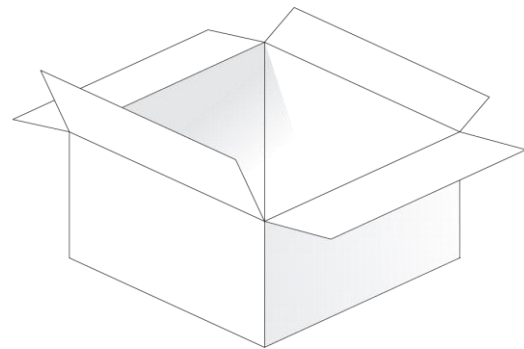



www.taoglas.com

