



TAOGLAS®



Datasheet

915MHz ISM Band Terminal Antenna

Part No:
TI.93.A111

Description

915MHz Terminal Antenna SMA Male Straight

Features:

902-928MHz Band Operation
IP67 Waterproof Rated
Low-profile Terminal Antenna
SMA(M) Straight Connector
Dimensions: \varnothing 8.9mm x 21mm
RoHS & Reach Compliant

1.	Introduction	2
2.	Specification	3
3.	Antenna Characteristics	4
4.	Radiation Patterns	7
5.	Mechanical Drawing	11
6.	Packaging	12
<hr/>		
	Changelog	13

Taoglas makes no warranties based on the accuracy or completeness of the contents of this document and reserves the right to make changes to specifications and product descriptions at any time without notice. Taoglas reserves all rights to this document and the information contained herein. Reproduction, use or disclosure to third parties without express permission is strictly prohibited.



1. Introduction



The TI.93 is one of a range of super small form factor, lightweight, IP67 rated terminal mount antennas from Taoglas. It is ideal for wireless applications operating on ISM or LoRa bands covering 902-928MHz. Its robust silicone enclosure is engineered to perform in the most challenging of external environments when connecting IoT devices to smart grid and smart monitoring applications.

With its IP67 rating, the TI.93 can withstand dust, dirt, and even complete submersion in water, making it the perfect choice for any IoT application that demands both reliable connectivity and extreme durability. Whether you're connecting sensors for remote agricultural, monitoring equipment in industrial settings, or building the infrastructure for smart cities, the TI.93 is a great solution.

If you are looking for an antenna that's small, tough, and versatile, look no further than the TI.93. Contact your regional Taoglas Customer Services Team for more information or to discuss your project.

2. Specification

ISM Electrical							
Band		Efficiency (%)	Average Gain (dB)	Peak Gain (dBi)	Impedance	Polarization	Radiation Pattern
ISM 902-928MHz	In Free space	16.7	-7.78	-1.73	50 Ω	Linear	Omni
	On 15x9cm Ground plane (Long side)	62.2	-2.06	1.12			
	On 9x15cm Ground plane (Short side)	52.5	-2.80	2.06			

Mechanical	
Dimensions	\varnothing 8.9mm x 21mm
Weight	3.3g
Material	Silicone
Connector	SMA(M)

Environmental	
Operating Temperature	-40°C ~ +85°C
Waterproof Rating	IP67

3. Antenna Characteristics

3.1 Test Setup

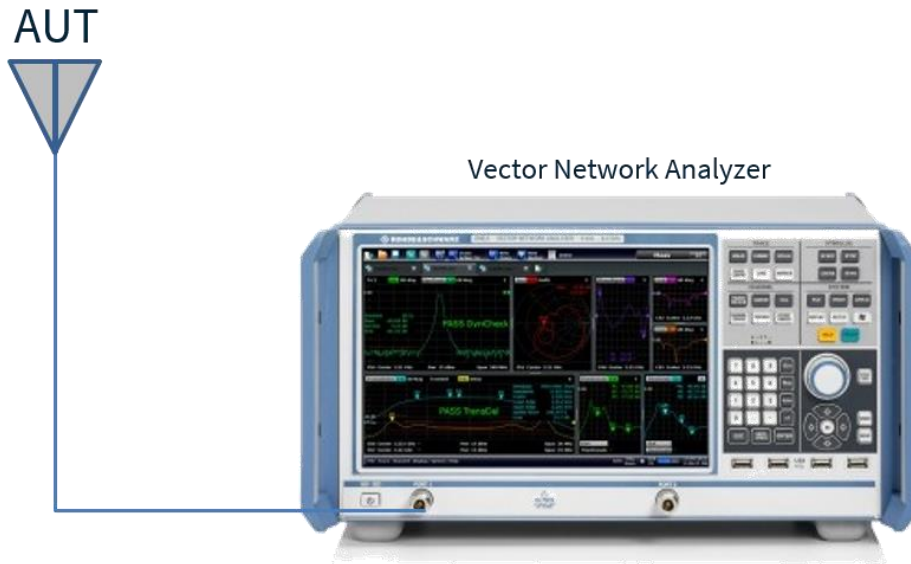

In Free Space

On 15x9cm Ground plane

On 9x15cm Ground plane

3.2 Return Loss

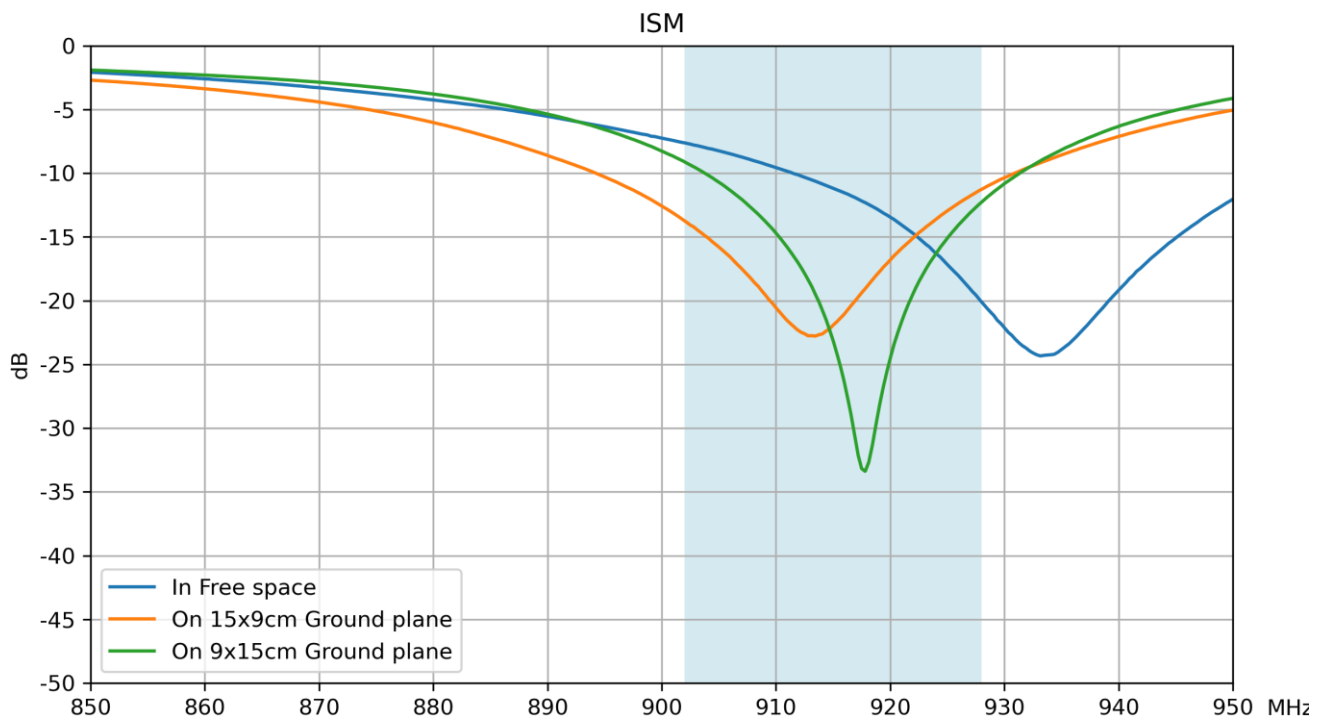

3.3 Efficiency

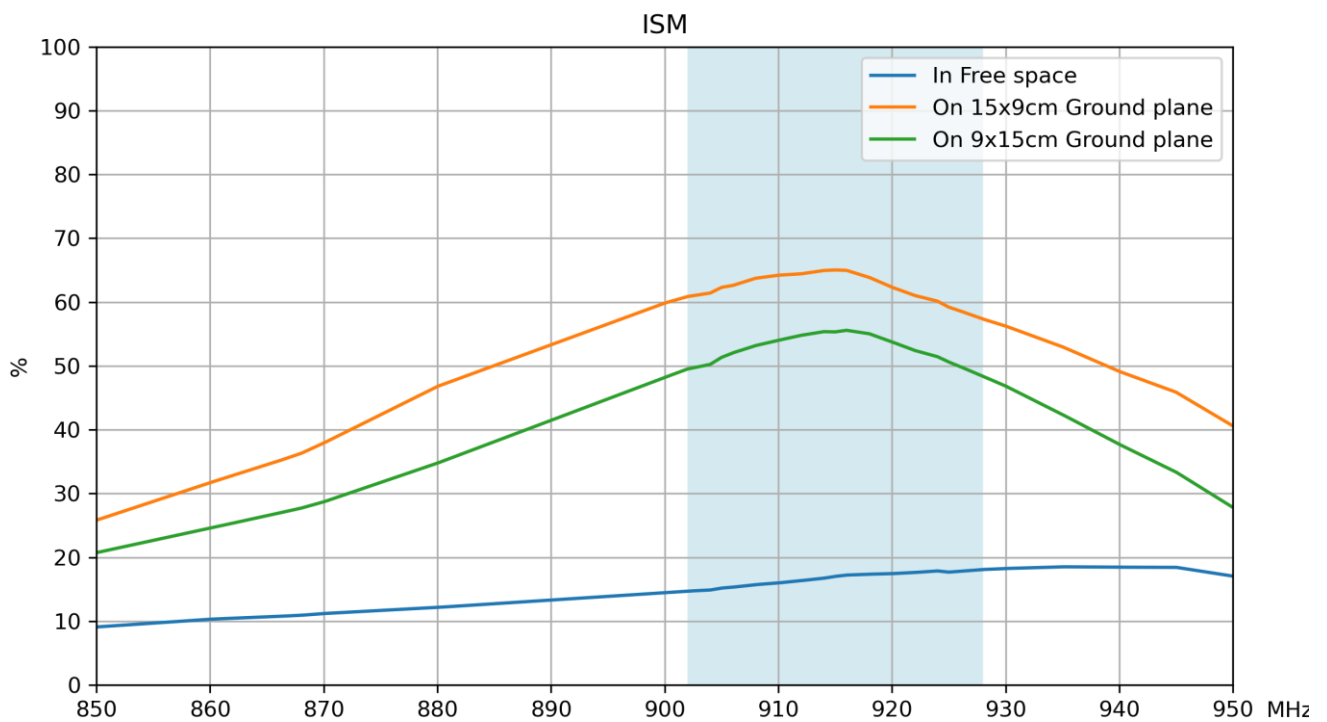

3.4 Average Gain

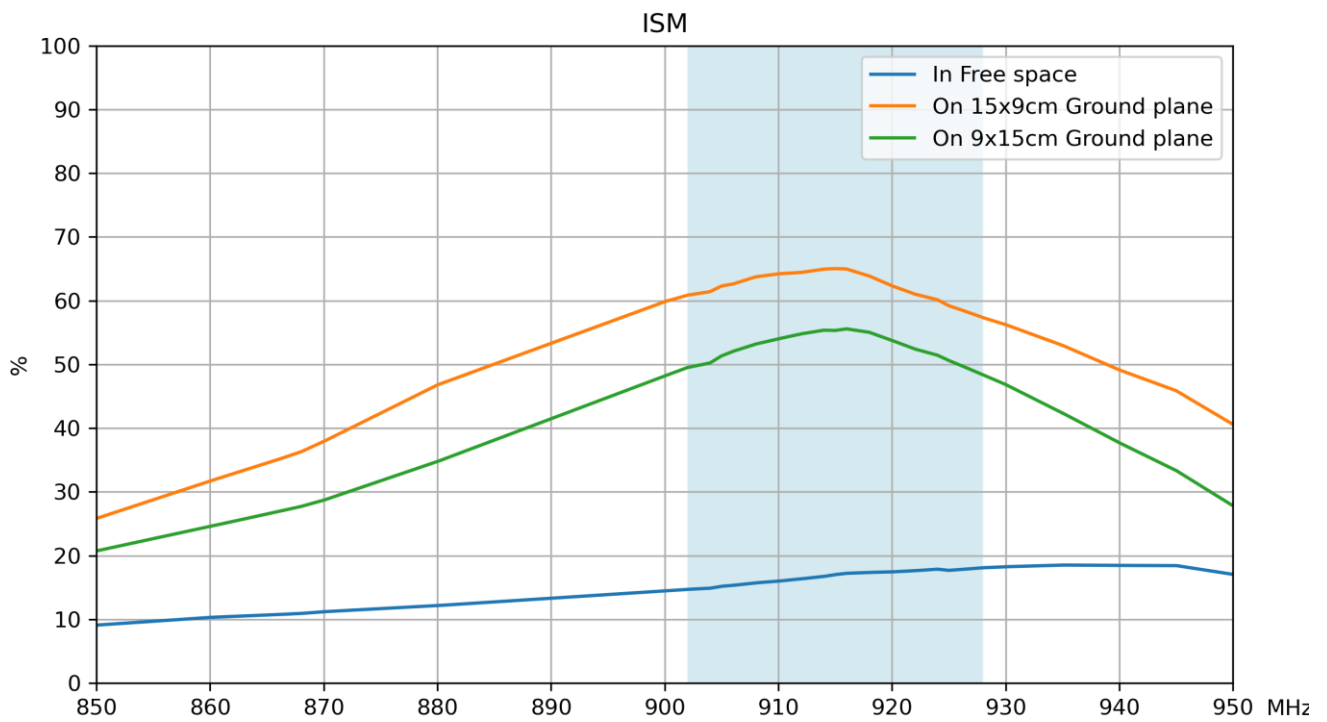

3.5 Peak Gain

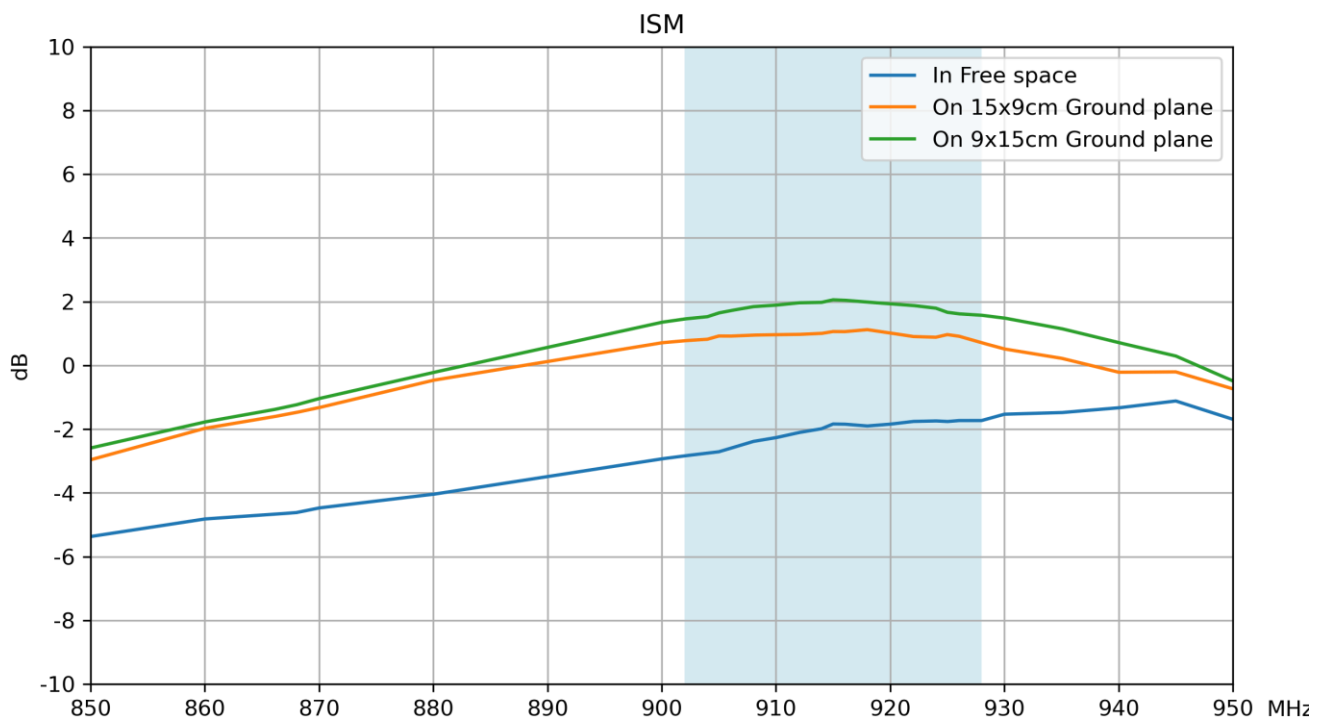

4. Radiation Patterns

4.1 Test Setup

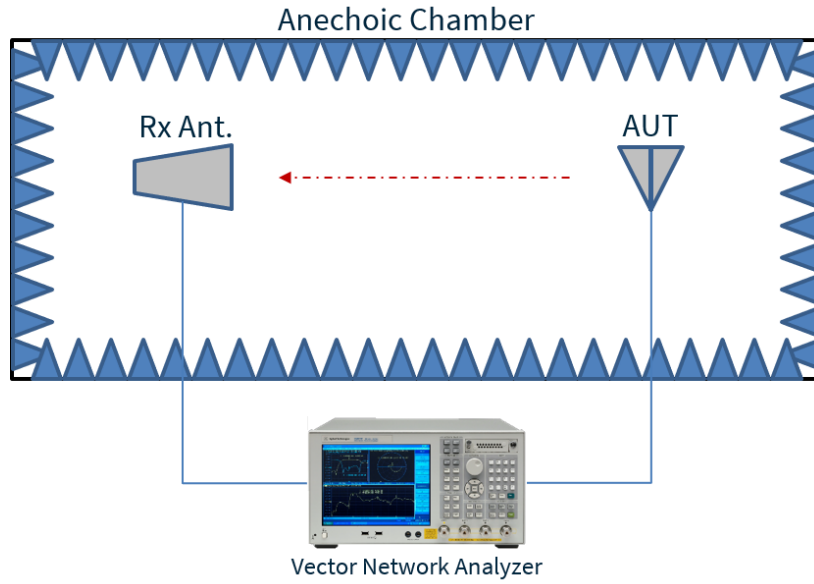

In Free Space

On 15x9cm Ground plane

On 9x15cm Ground plane

4.2 TI.93.A.111 - Patterns at 915 MHz in Free Space

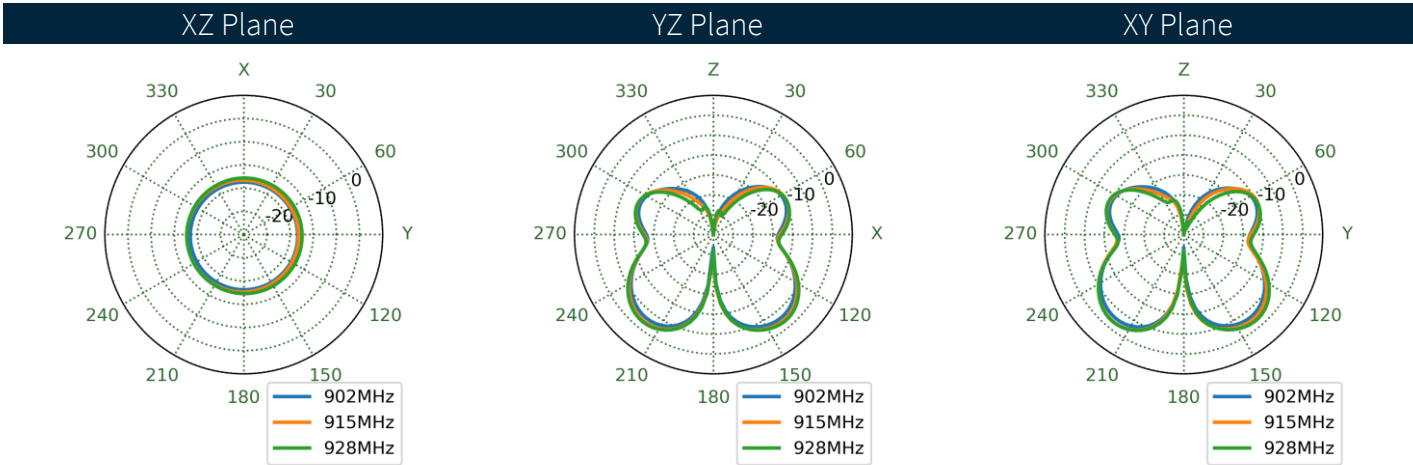
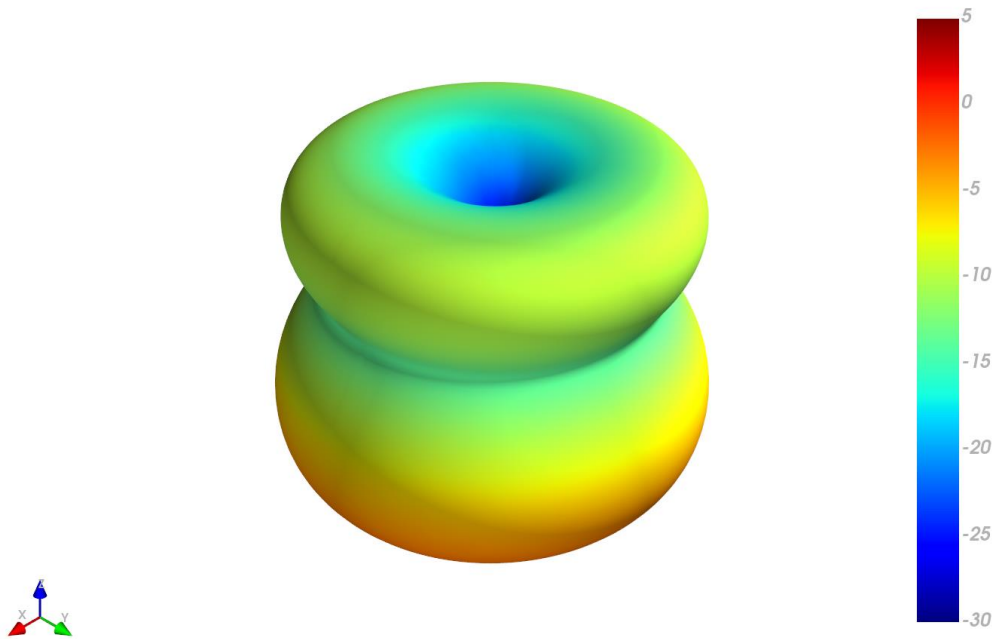

4.3 TI.93.A111 - Patterns at 915 MHz on 15x9cm ground plane

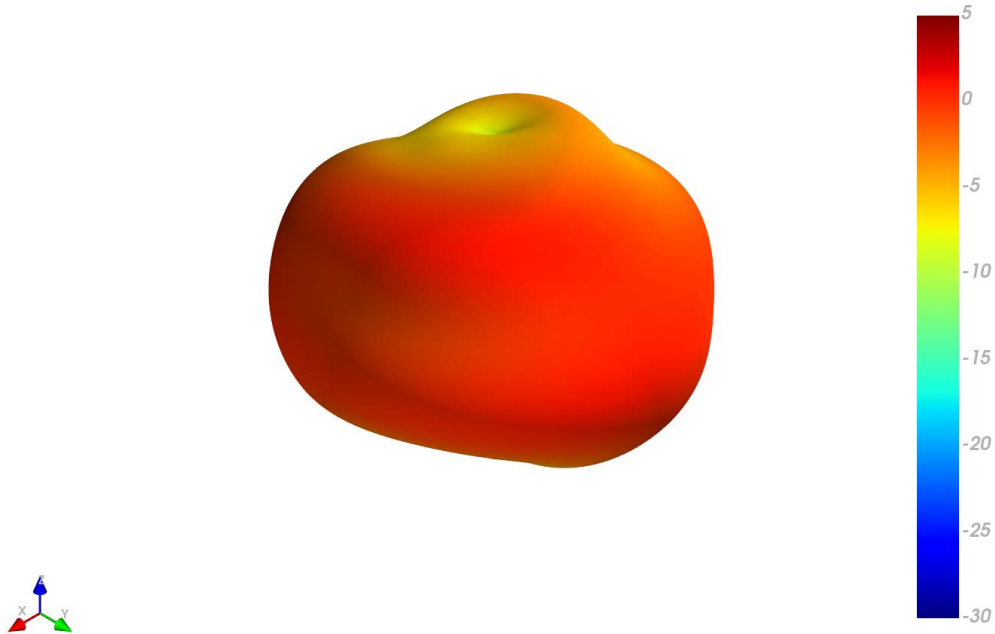

XZ Plane YZ Plane XY Plane

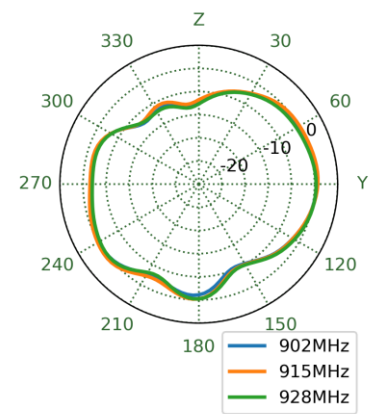
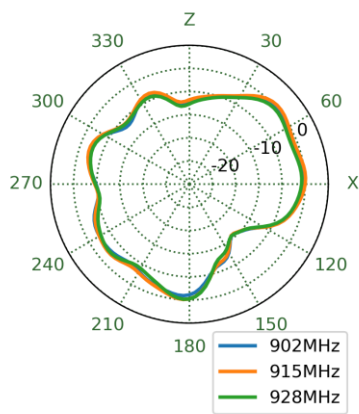
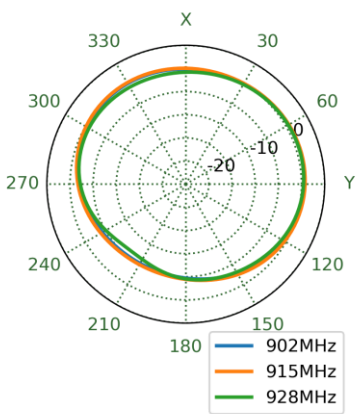

4.4 TI.93.A111- Patterns at 915 MHz on 9x15cm ground plane

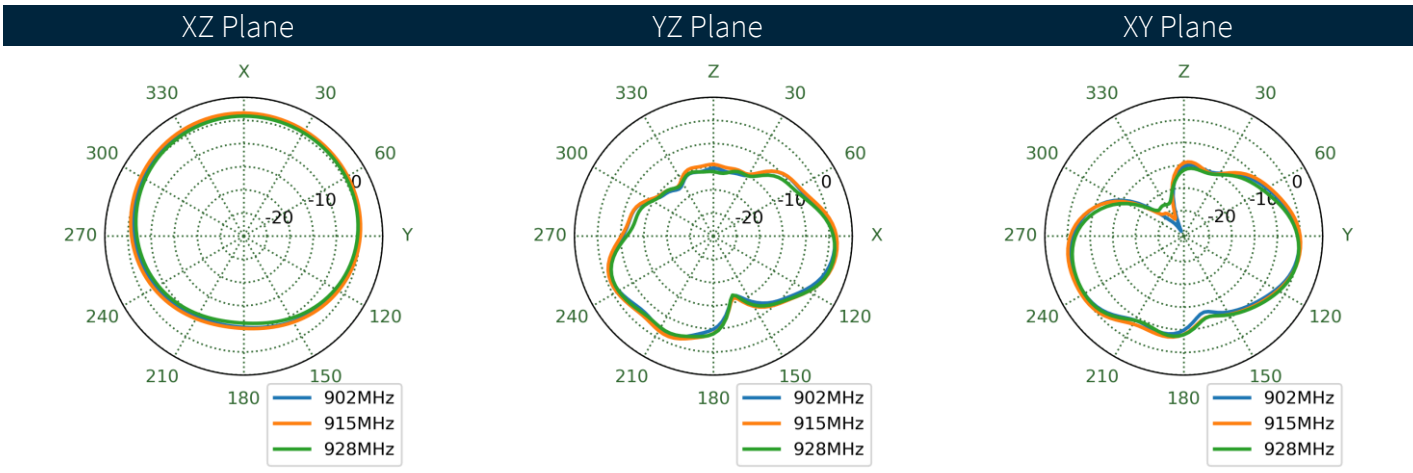
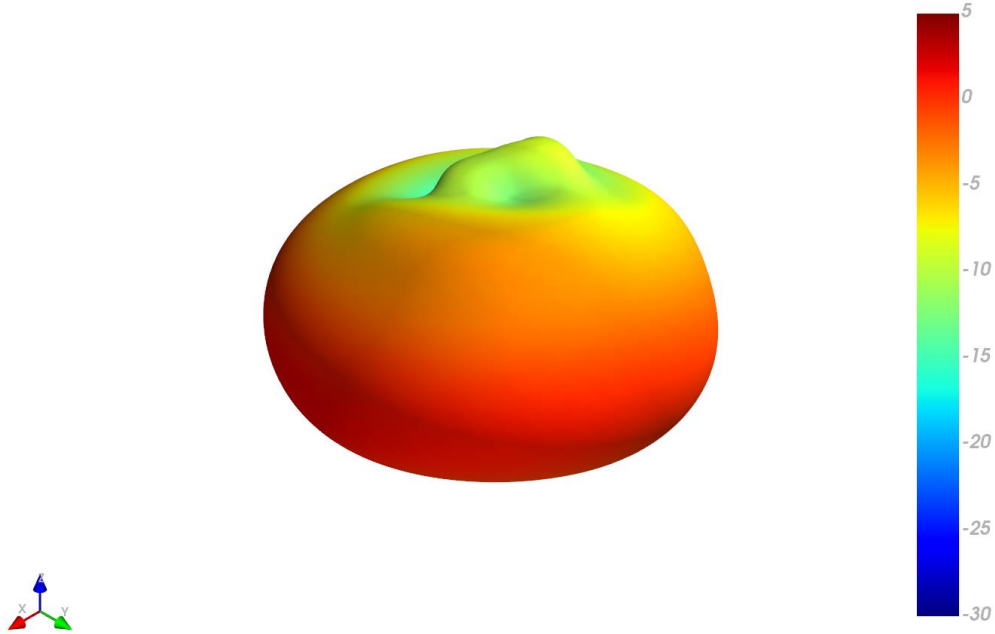

5. Mechanical Drawing

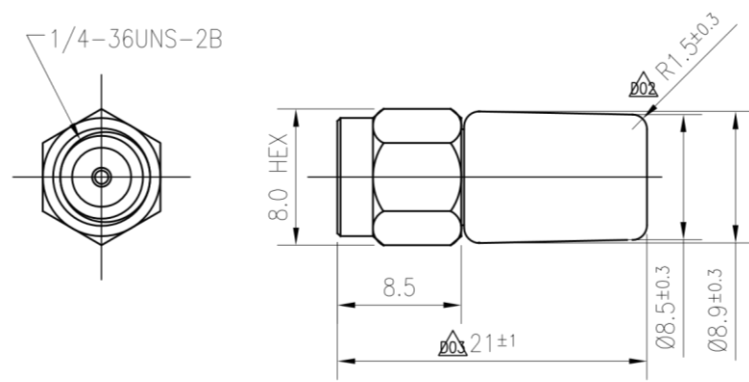

6. Packaging

140pcs TI.93.A111 per Tray
Weight: 0.52Kg

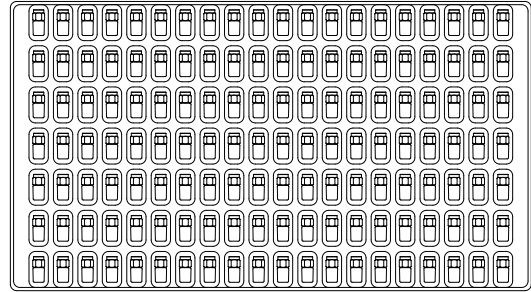

8 SET per Tray
Weight: 4.2Kg

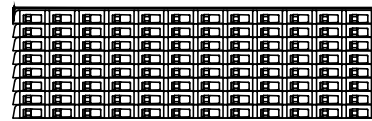
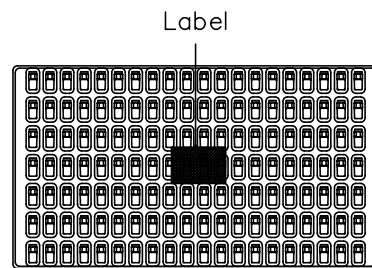

1120pcs per Carton
Dimensions: 425x240x130mm
Weight: 4.65Kg

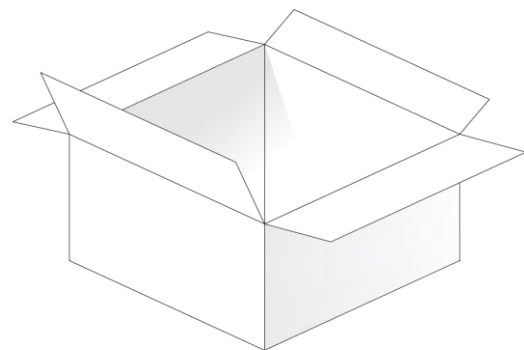



www.taoglas.com

