



TAOGLAS®



Datasheet

Accura Series

Part No:
TS.15.0111

Description

Passive GPS/GLONASS/Galileo/BeiDou Antenna

Features:

High Performance Passive GPS Direct Mount Antenna
Robust IP67 Waterproof Enclosure
Dims: $\varnothing 27.25\text{mm} * 60\text{mm}$
Connector: SMA Male
RoHS & Reach Compliant

1.	Introduction	3
2.	Specification	4
3.	Antenna Characteristics	6
4.	Radiation Patterns	9
5.	Field Test Results	19
6.	Mechanical Drawing	20
7.	Installation Guide	21
8.	Packaging	22
<hr/>		
	Changelog	23

Taoglas makes no warranties based on the accuracy or completeness of the contents of this document and reserves the right to make changes to specifications and product descriptions at any time without notice. Taoglas reserves all rights to this document and the information contained herein. Reproduction, use or disclosure to third parties without express permission is strictly prohibited.



1. Introduction



The **TS.15.0111 Accura Series** from Taoglas is a small, lightweight, high-performance GNSS direct SMA(M) mount passive antenna. Covering GPS L1, Galileo E1, GLONASS G1 and BeiDou B1 bands, it is also engineered to cover the L-Band used in modern GNSS correctional services. The direct mount enclosure is built to withstand the harshest environments, making it ideal for applications in transportation, navigation, connected robotics and UAV's, and remote asset tracking.

Some key features for the TS.15 include:

- **IP67 water resistance:** Withstands rain, dust, and even temporary submersion.
- **Waterproof O-ring:** Keeps water out, even in the most challenging conditions.
- **Robust external enclosure:** Protects the antenna from shock, vibration, and impact.
- **Secure mounting:** Unique indented SMA(M) connector ensure a solid, reliable connection.

Whether you're tracking vehicles, autonomous robotics or UAV's, navigating remote areas, or connecting your enterprise assets, the TS.15 delivers reliable GPS performance you can count on. For an active version of the product, look at the **TS.16.0111** on www.taoglas.com.

Contact your local Taoglas customer support team to learn more about how this versatile antenna can meet your specific needs.

2. Specification

GNSS Frequency Bands					
GPS	L1 1575.42 MHz	L2 1227.6 MHz	L5 1176.45 MHz		
	■	□	□		
GLONASS	G1 1602 MHz	G2 1248 MHz	G3 1207 MHz		
	■	□	□		
Galileo	E1 1575.24 MHz	E5a 1176.45 MHz	E5b 1201.5 MHz	E6 1278.75 MHz	
	■	□	□	□	
BeiDou	B1C 1575.42 MHz	B1I 1561 MHz	B2a 1176.45 MHz	B2b 1207.14 MHz	B3 1268.52 MHz
	■	■	□	□	□
L-Band	L-Band 1542 MHz				
	■				
QZSS (Regional)	L1 1575.42 MHz	L2C 1227.6 MHz	L5 1176.45 MHz	L6 1278.75e6	
	■	□	□	□	
IRNSS (Regional)	L5 1176.45 MHz				
	□				
SBAS	L1/E1/B1 1575.42 MHz	L5/B2a/E5a 1176.45 MHz	G1 1602 MHz	G2 1248 MHz	G3 1207 MHz
	■	□	■	□	□

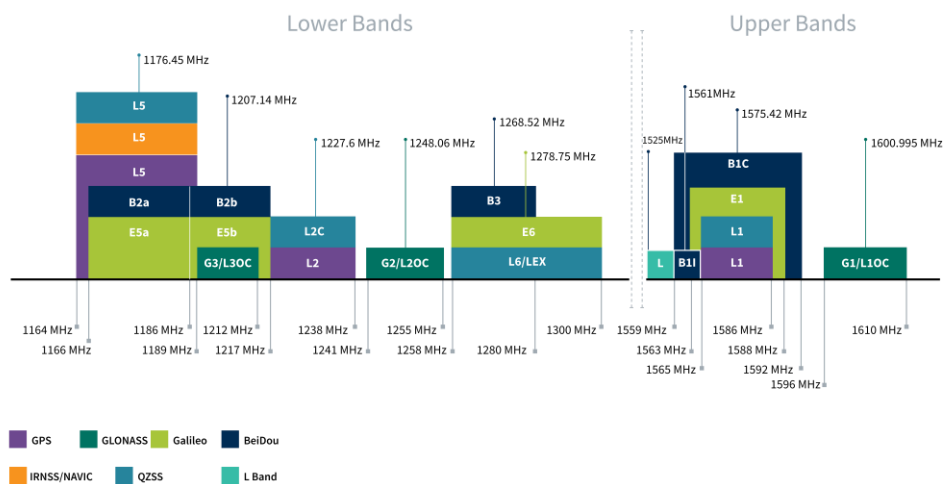

GNSS Bands and Constellations

GNSS Electrical			
Frequency (MHz)	1561	1575.42	1603
VSWR (max.)	2:1	2:1	2:1
Passive Antenna Efficiency (%)	52.35	56.13	48.58
Passive Antenna Gain at Zenith (dBi)	1.19	2.29	1.4
Axial Ratio (dB)	0.49	0.77	0.94
Group Delay Mean (ns)	-4.8	-3.02	46.73
Polarization		RHCP	
Impedance		50 Ω	
*Results shown are tested in Free Space			

Mechanical	
Dimensions	60 x 27.25 mm
Weight	17g
Material	PC+ASA
Connector	SMA Male Connector

Environmental	
Operation Temperature	-40°C - +85°C
Storage Temperature	-40°C - +85°C
Waterproof	IP67

3. Antenna Characteristics

3.1 Return Loss

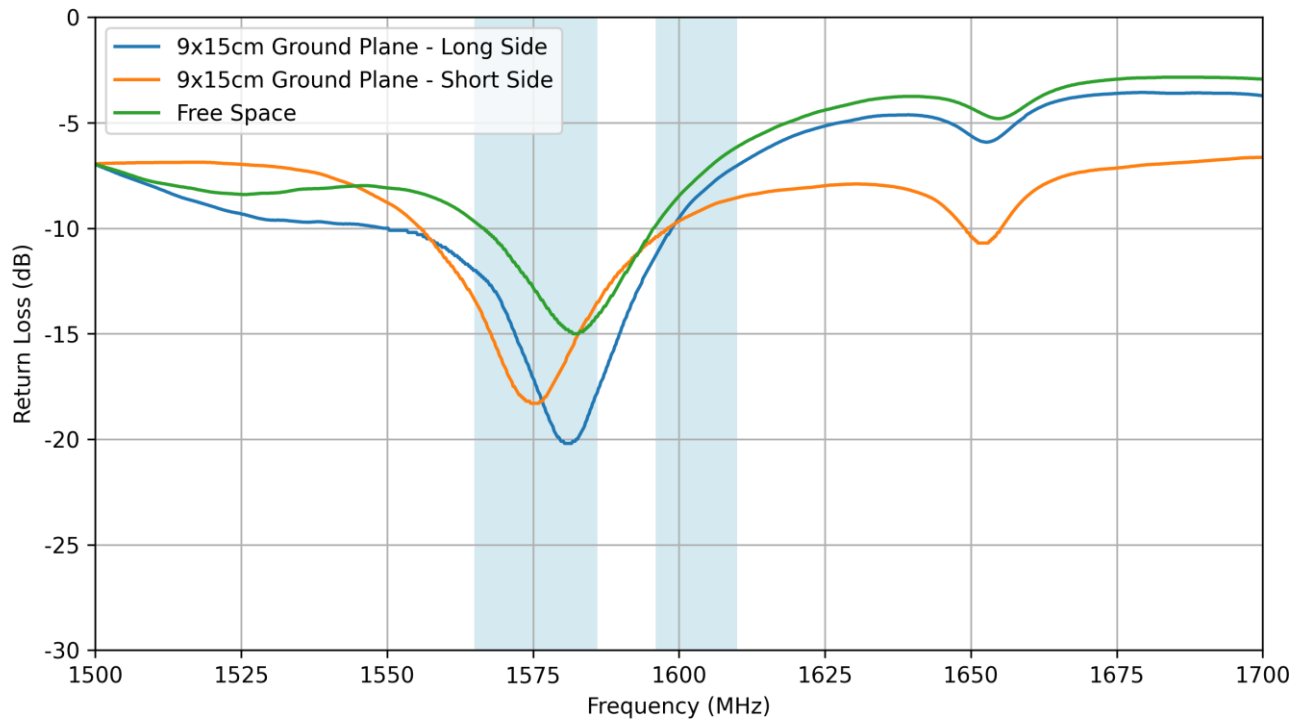

3.2 VSWR

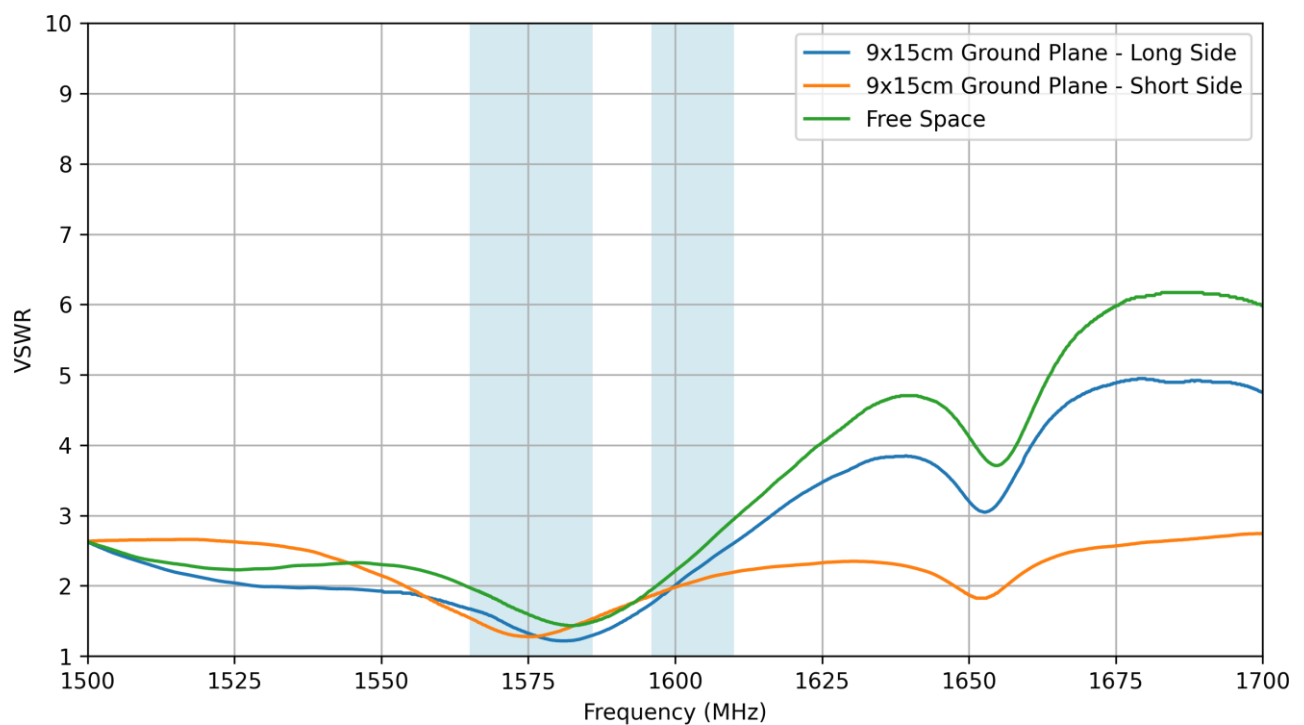

3.3 Efficiency

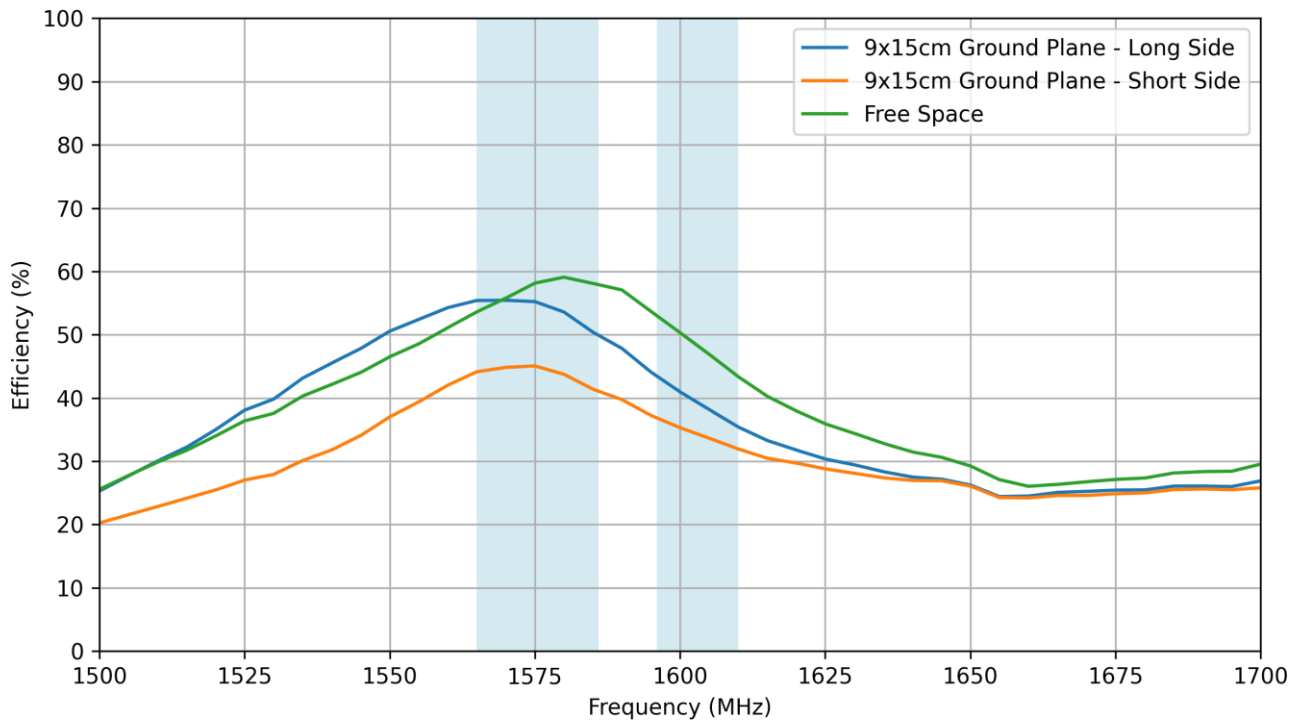

3.4 Average Gain

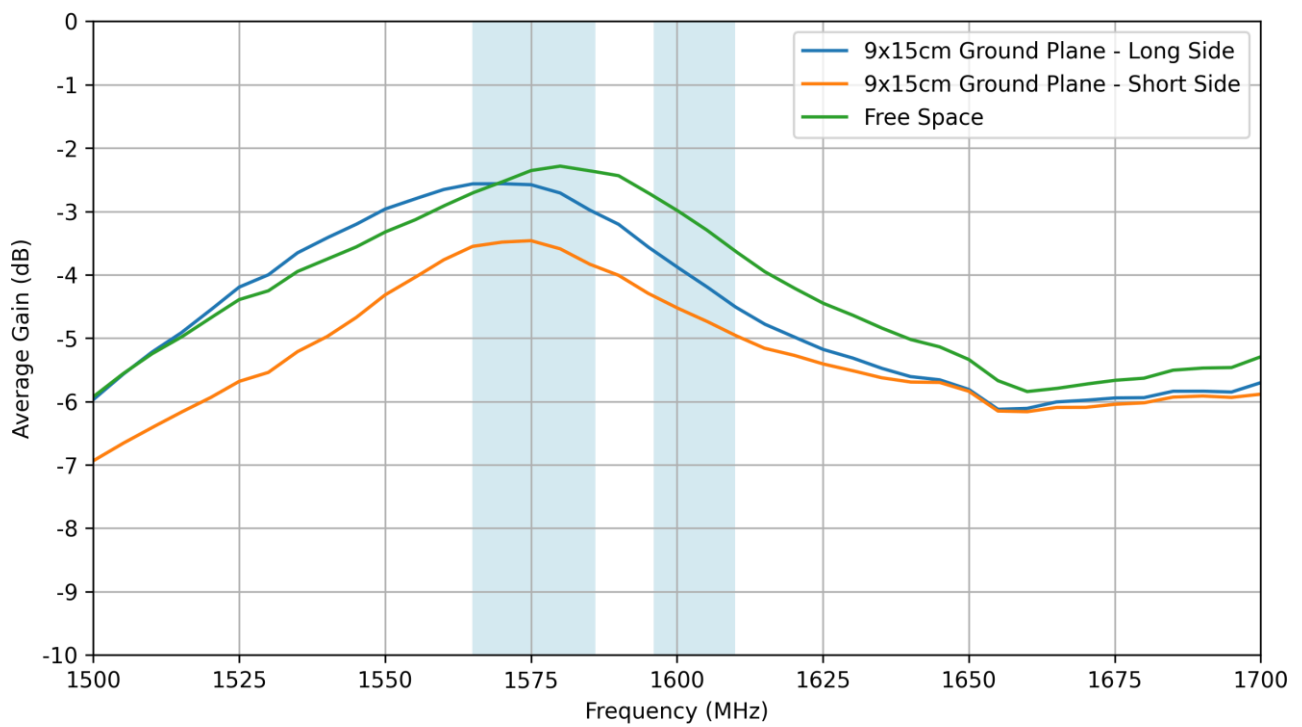

3.5 Peak Gain

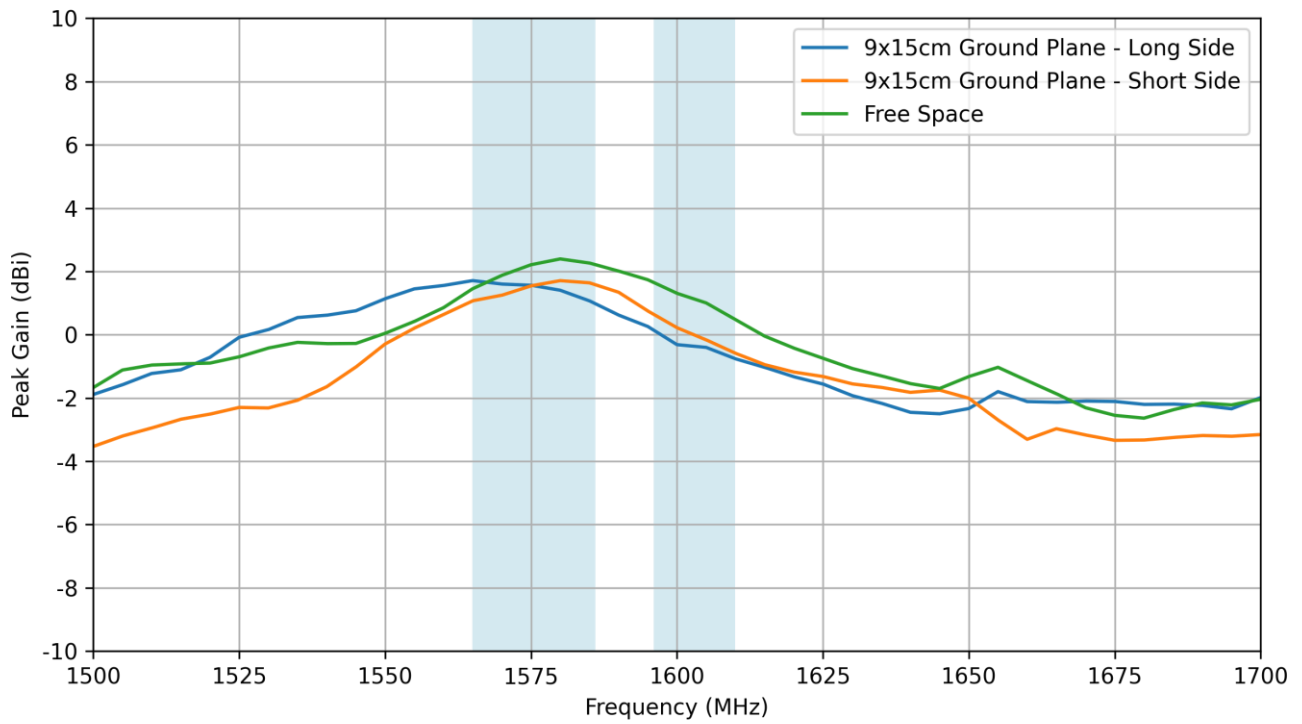

3.6 Axial Ratio

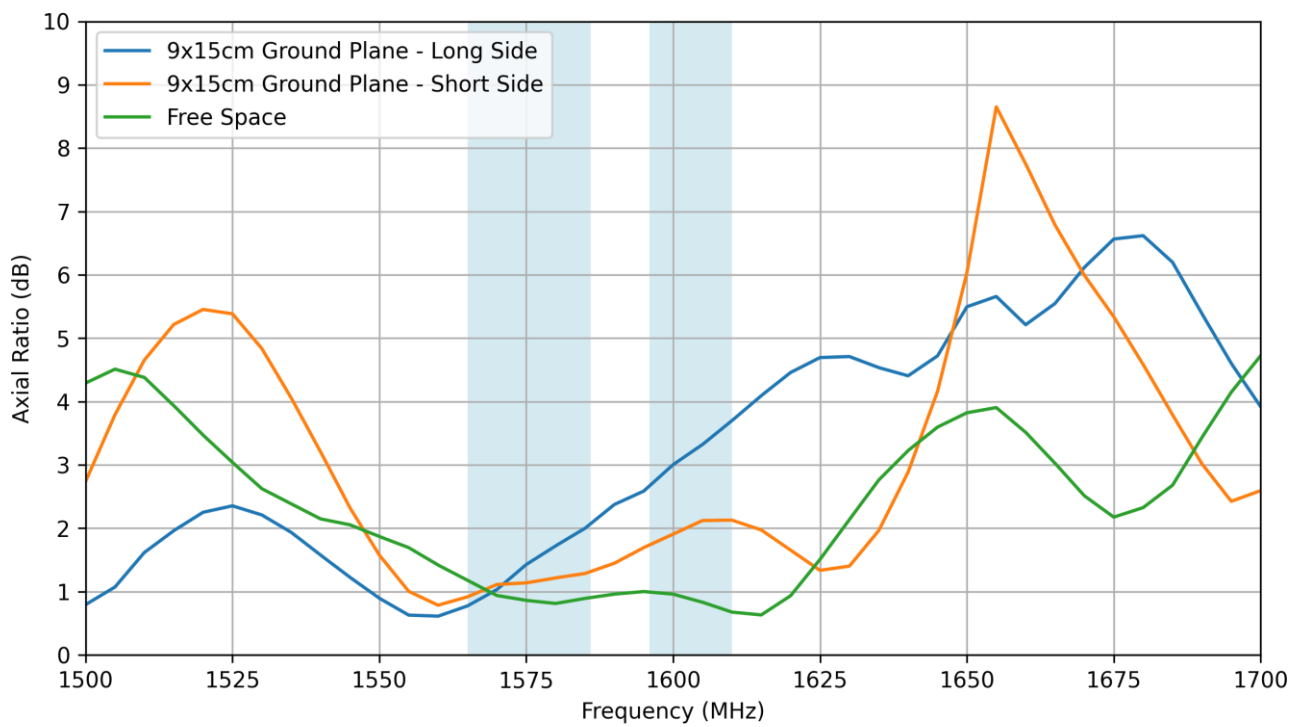

4. Radiation Patterns

4.1 Test Setup

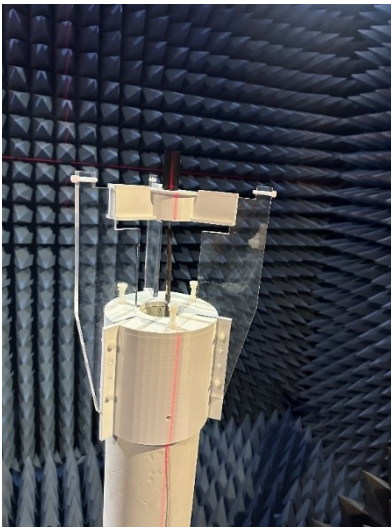
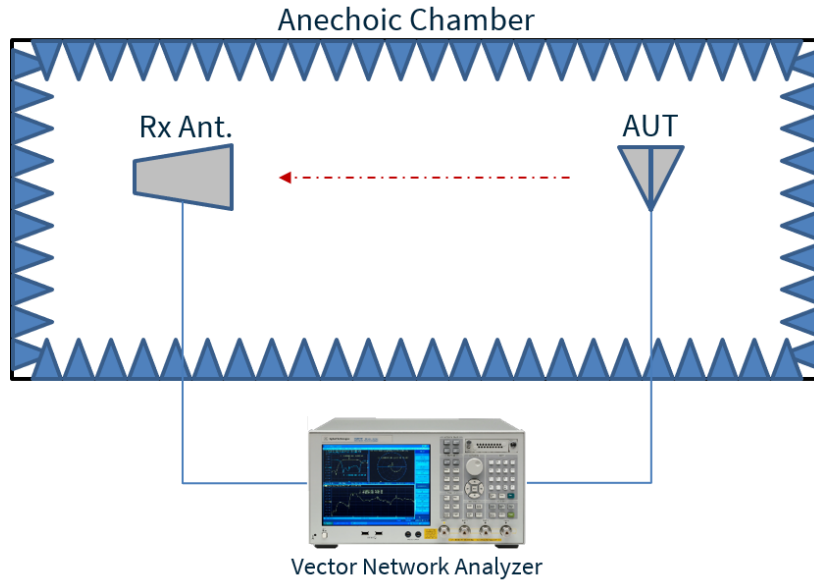

TS.15 Tested in Free Space

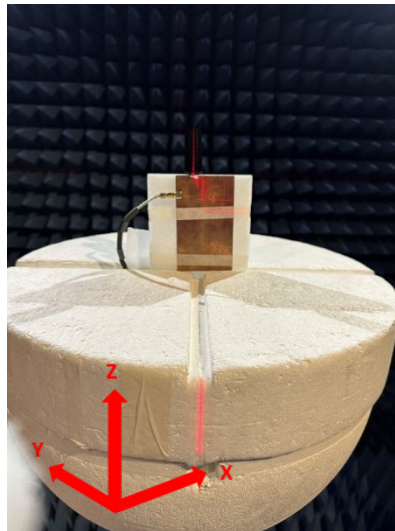

TS.15 Tested on 9x15cm Ground Plane

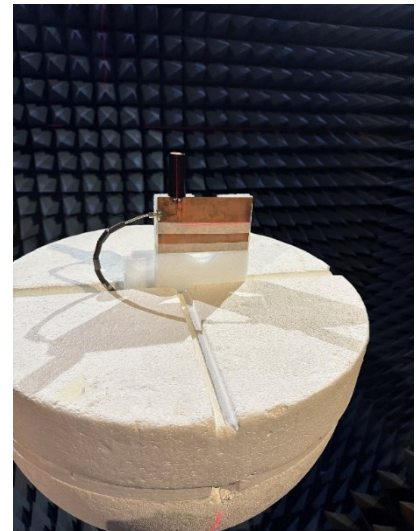

TS.15 Tested on 15x9cm Ground Plane

4.2 9x15cm Ground Plane (Long Side) Patterns at 1561 MHz

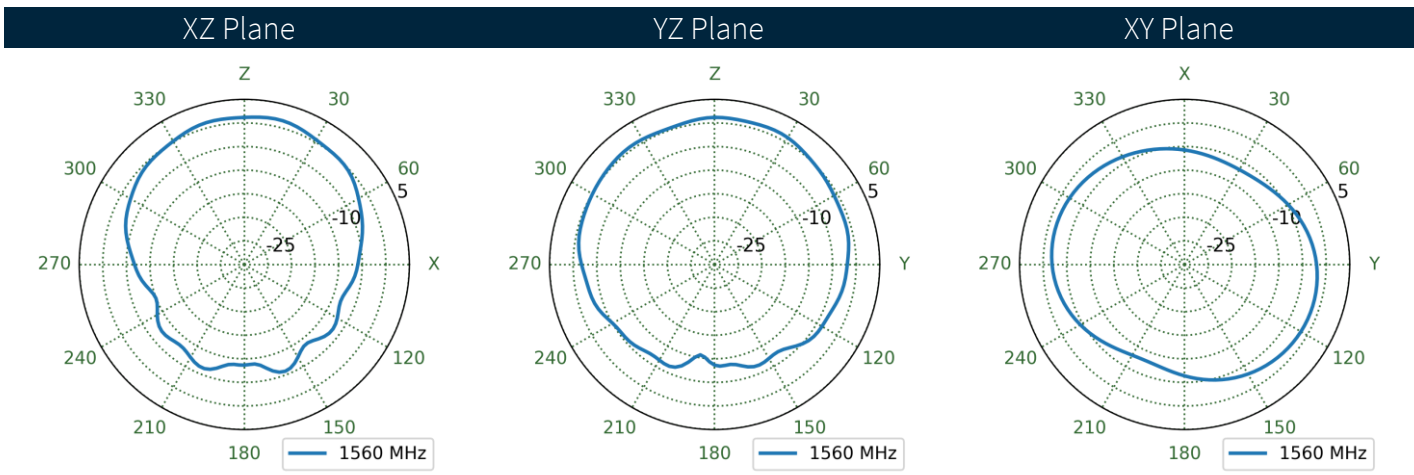
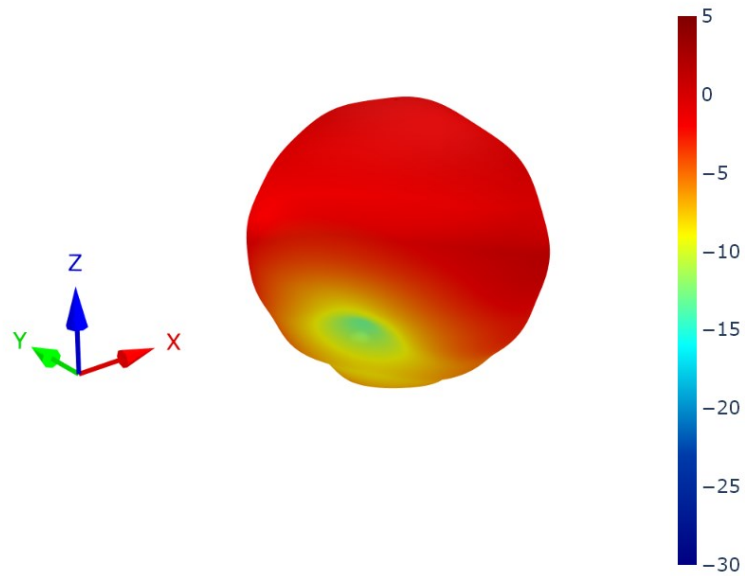

4.3 9x15cm Ground Plane (Short Side) Patterns at 1561 MHz

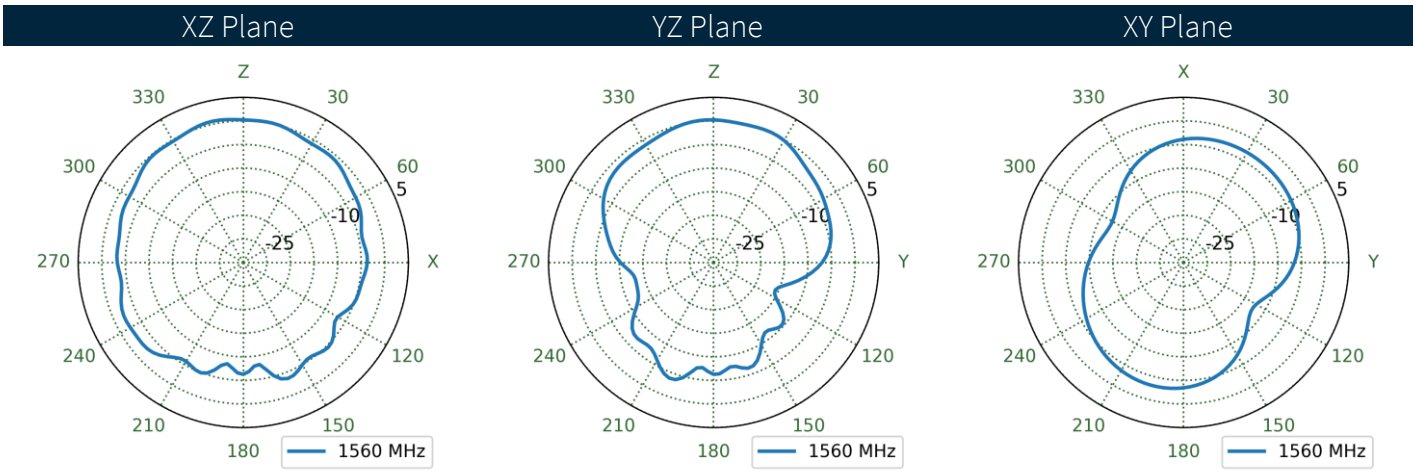
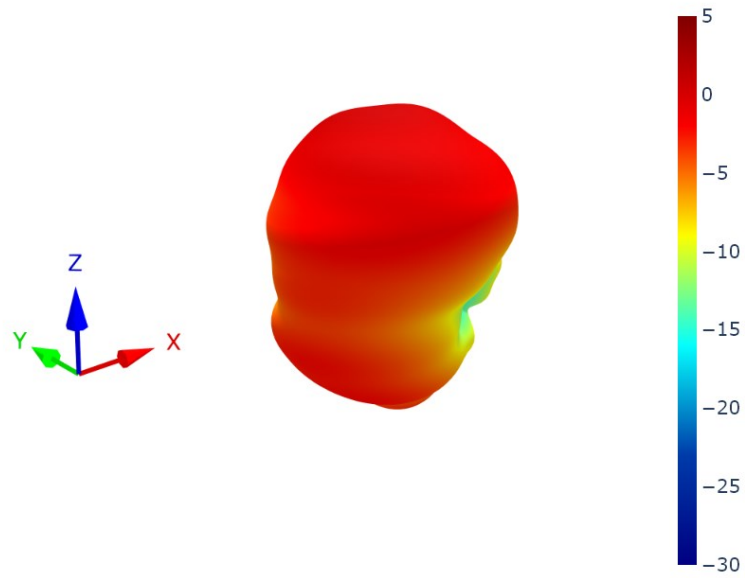

4.4 Free Space Patterns at 1561 MHz

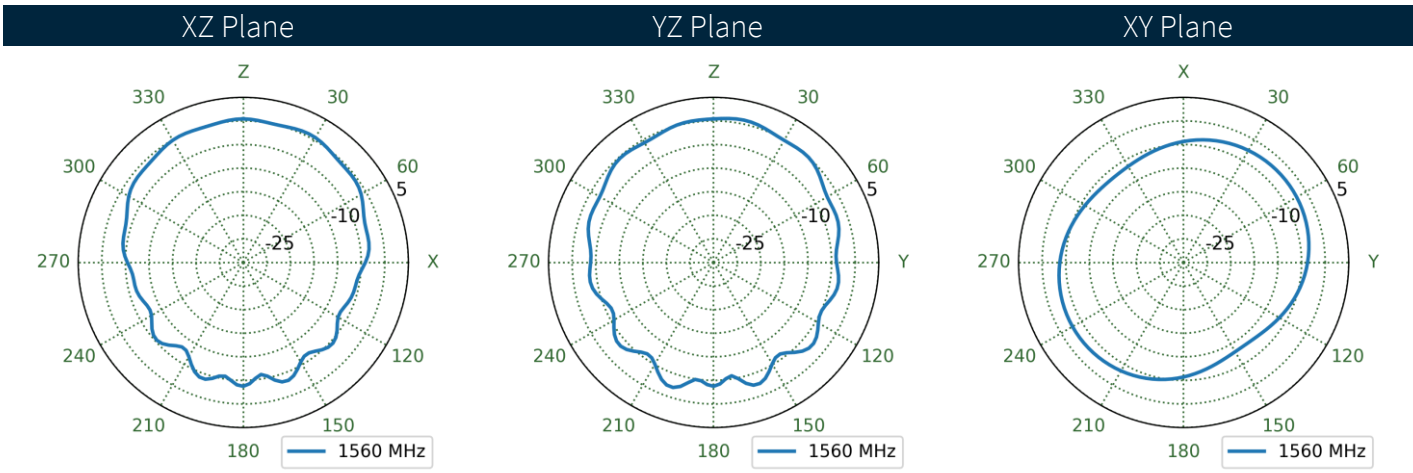
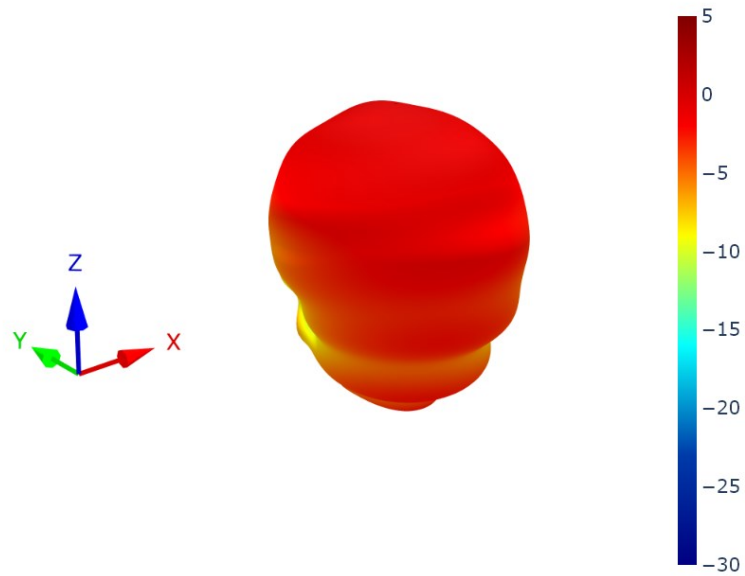

4.5 9x15cm Ground Plane (Long Side) Patterns at 1575 MHz

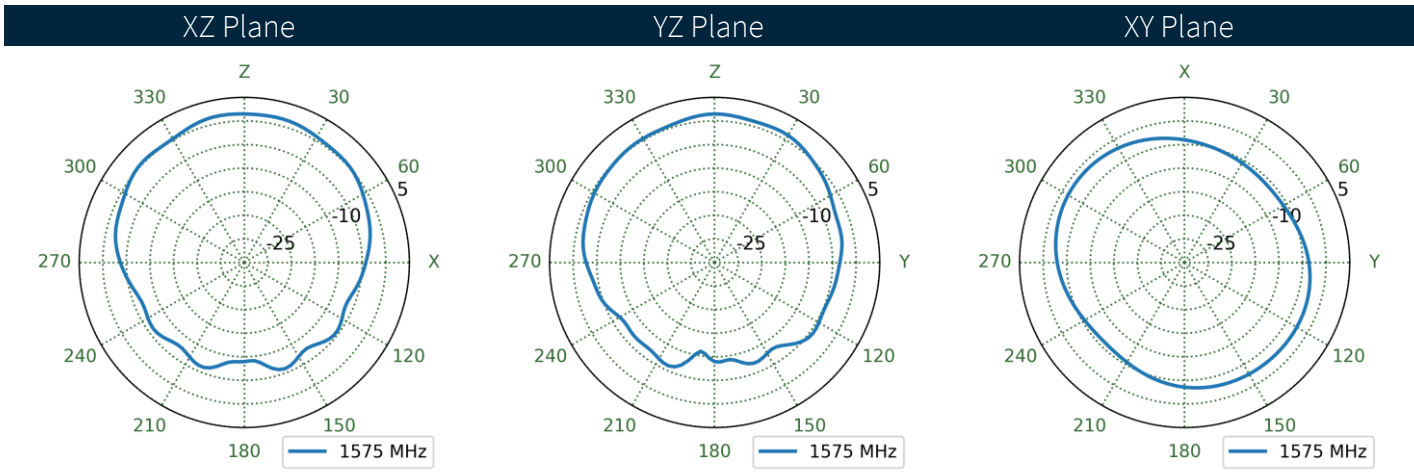
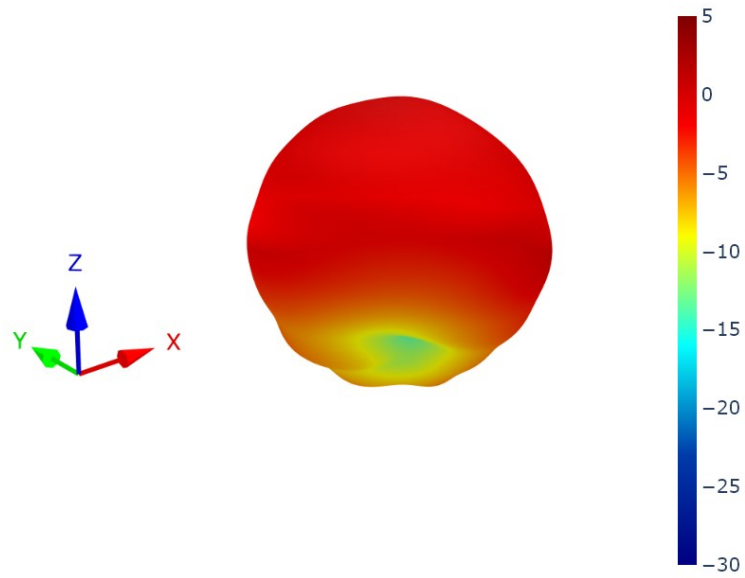

4.6 9x15cm Ground Plane (Short Side) Patterns at 1575 MHz

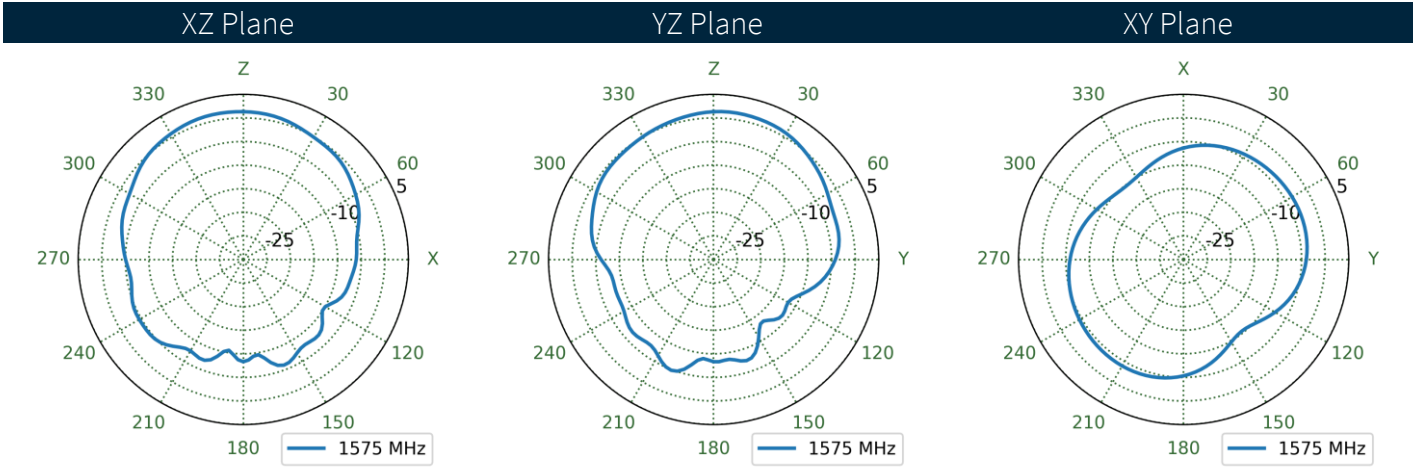
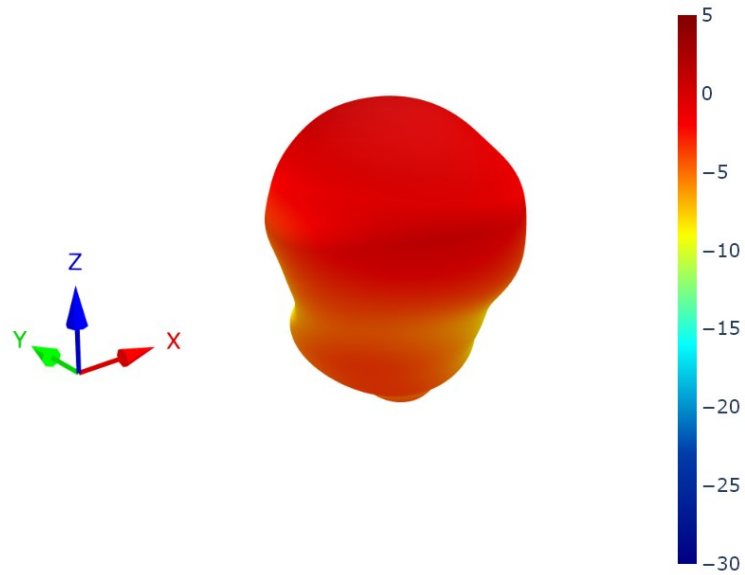

4.7 Free Space Patterns at 1575 MHz

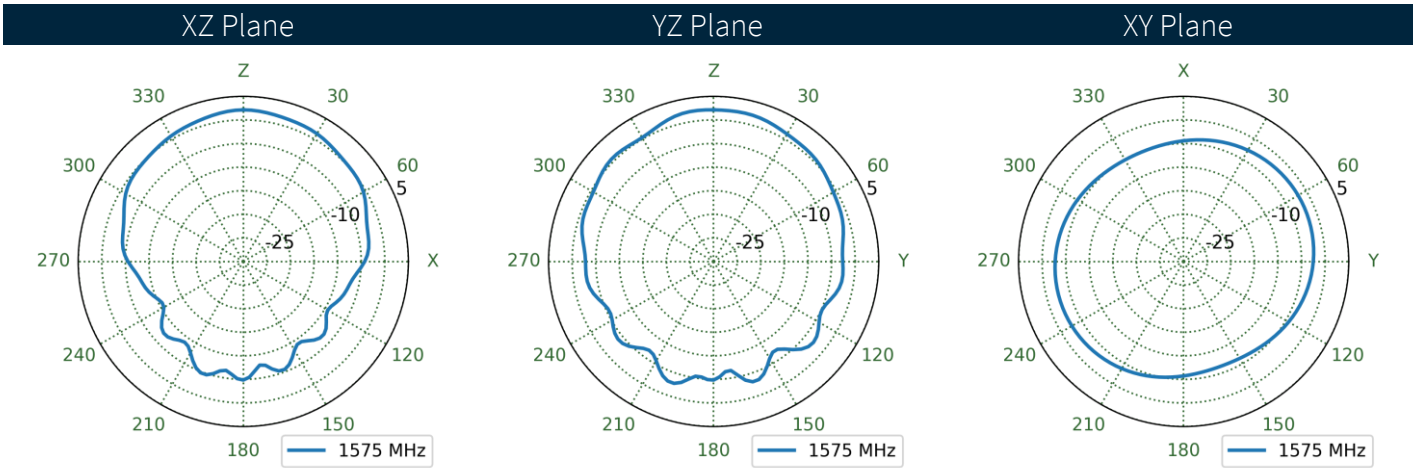
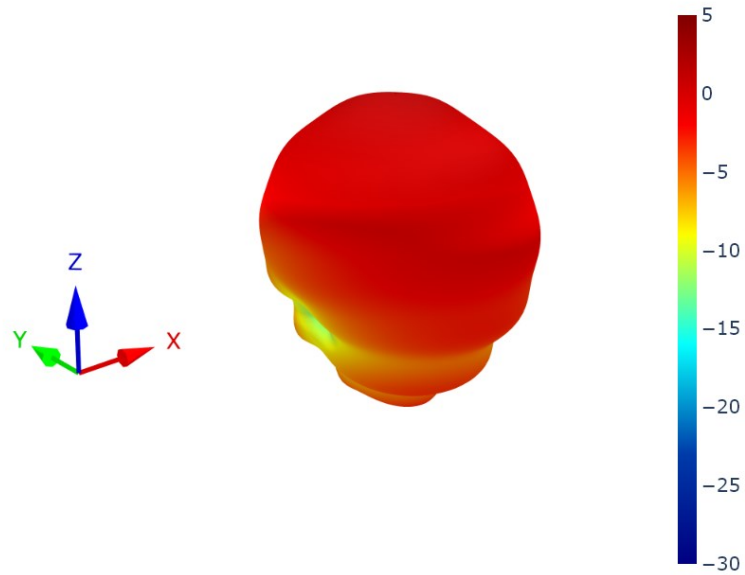

4.8 9x15cm Ground Plane (Long Side) Patterns at 1602 MHz

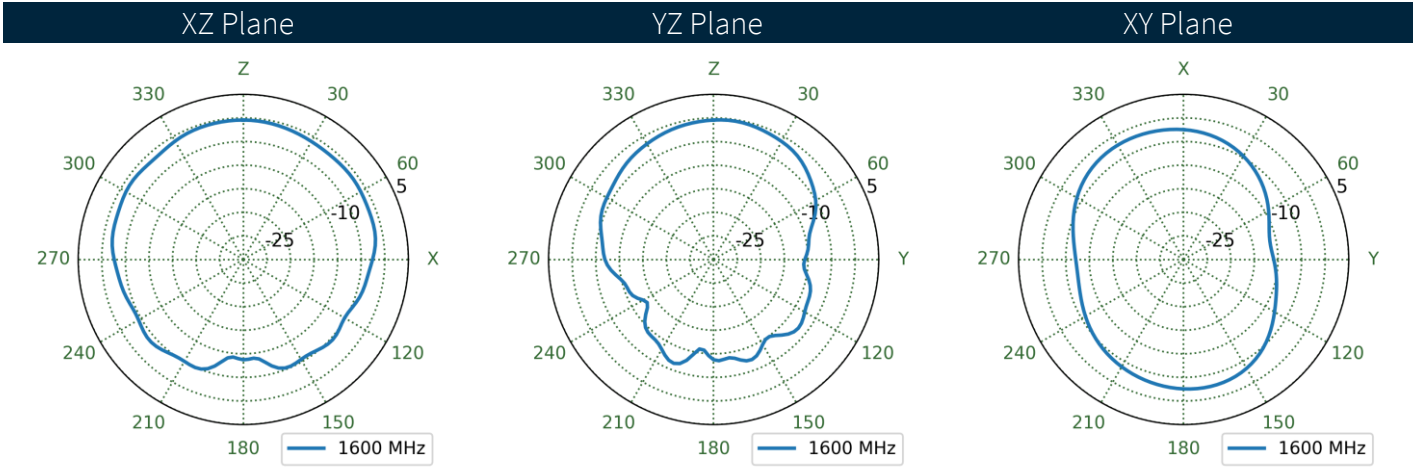
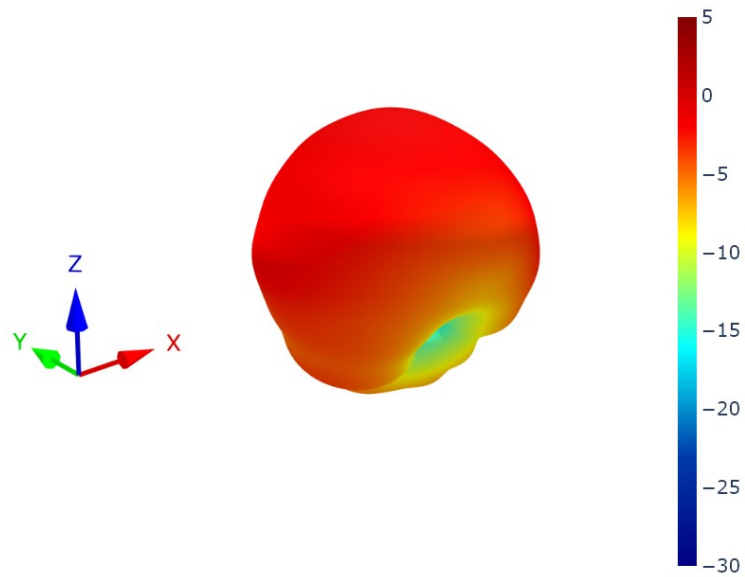

4.9 9x15cm Ground Plane (Short Side) Patterns at 1602 MHz

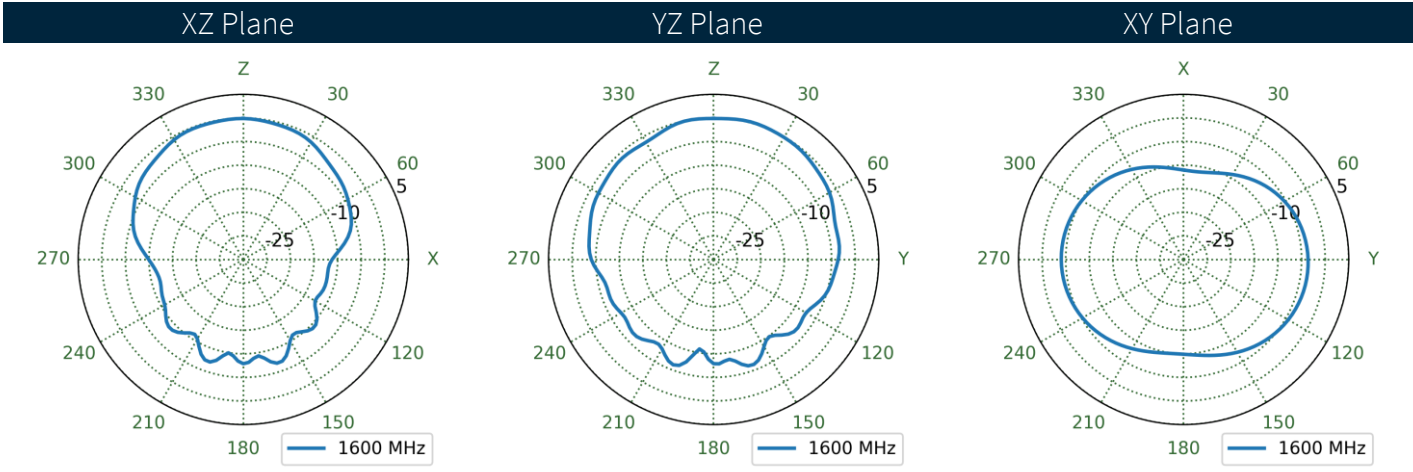
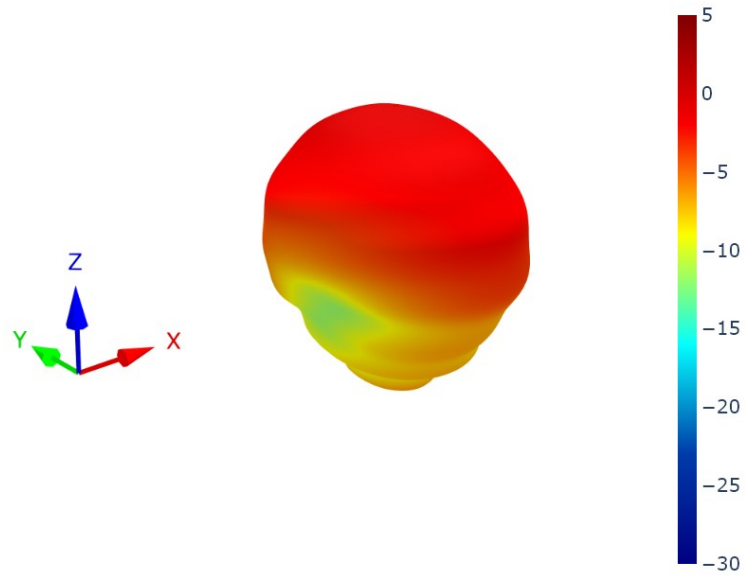

4.10 Free Space Patterns at 1602 MHz

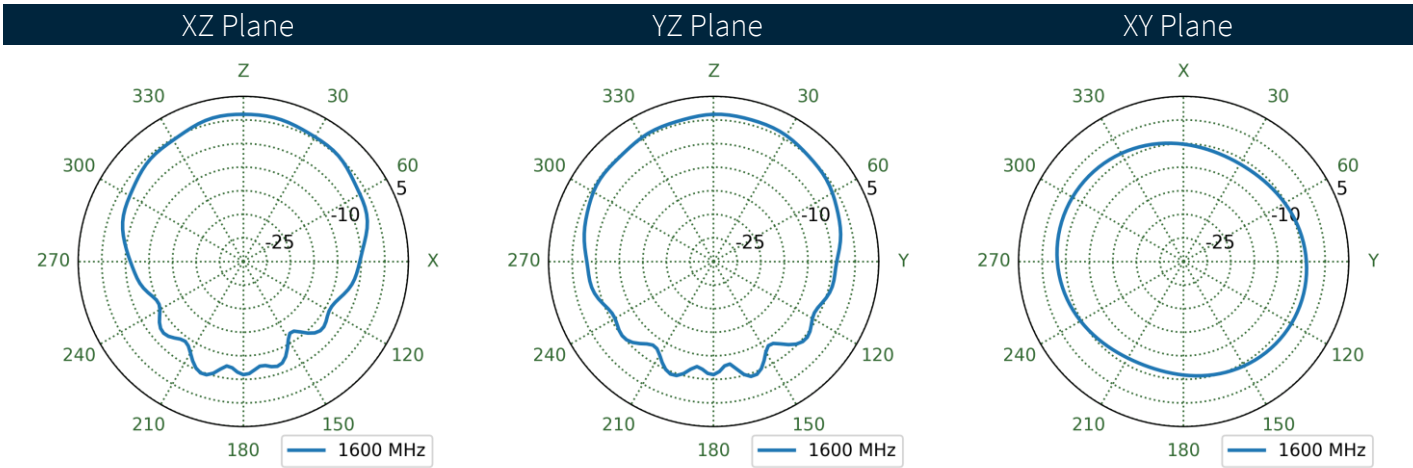
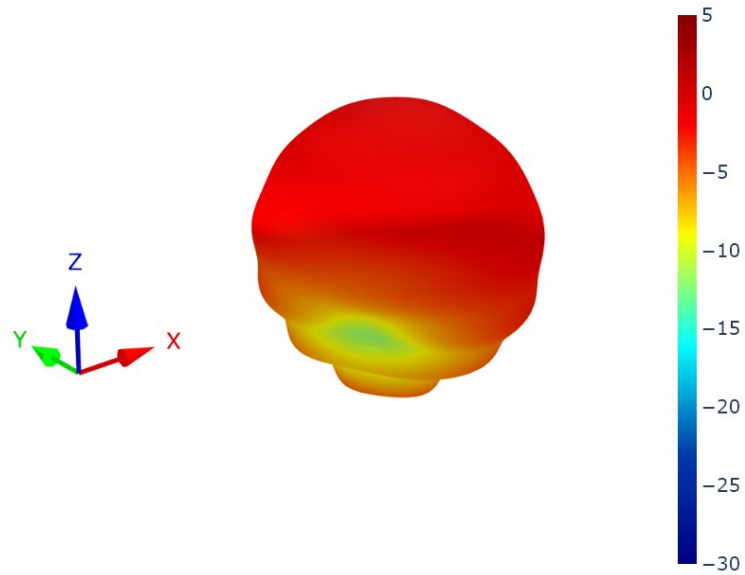

5. Field Test Results

In this section Taoglas will present the field test result for TS.15.0111 antenna. The test was performed when the antenna was mounted on a static rooftop test set up in an open sky environment for at least 6 hours.

Taoglas will show the field test results using the following receivers:

5.1 Ublox ZED-F9P

Receiver features:

- Multi-band GNSS: 184-channel GPS L1C/A L2C, GLONASS: L1OF L2OF, Galileo: E1B/C E5b, BeiDou: B1I B2I, QZSS: L1C/A L2C
- Multi-band RTK with fast convergence times and reliable performance
- Nav. update rate RTK up to 20 Hz
- Position accuracy = RTK 0.01 m + 1 ppm CEP

Positioning Accuracy Table (2D Accuracy)							
Test Condition	Correction Service	CEP (50%)	DRMS (68%)	2DRMS (95%)	TTF (sec) [GPS, DGPS, Float, Fixed]	GPS Fix %	DGPS Fix %
Free Space	No Correction	60.5 cm	72.64 cm	145.28 cm	32s	0%	100%
					71s		

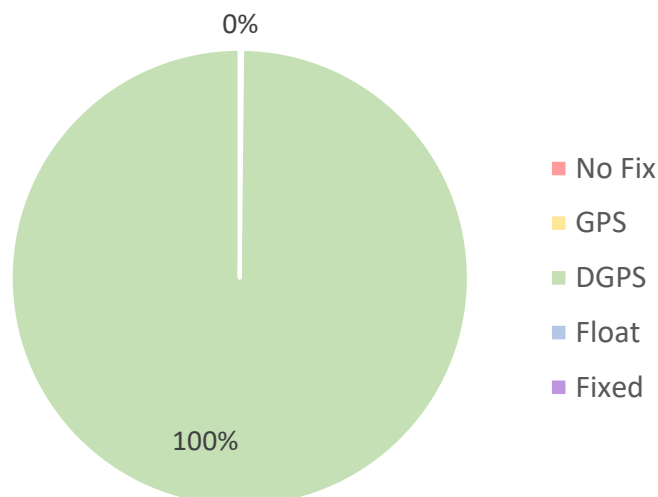

6. Mechanical Drawing

, molding supplier need
scribe the part.

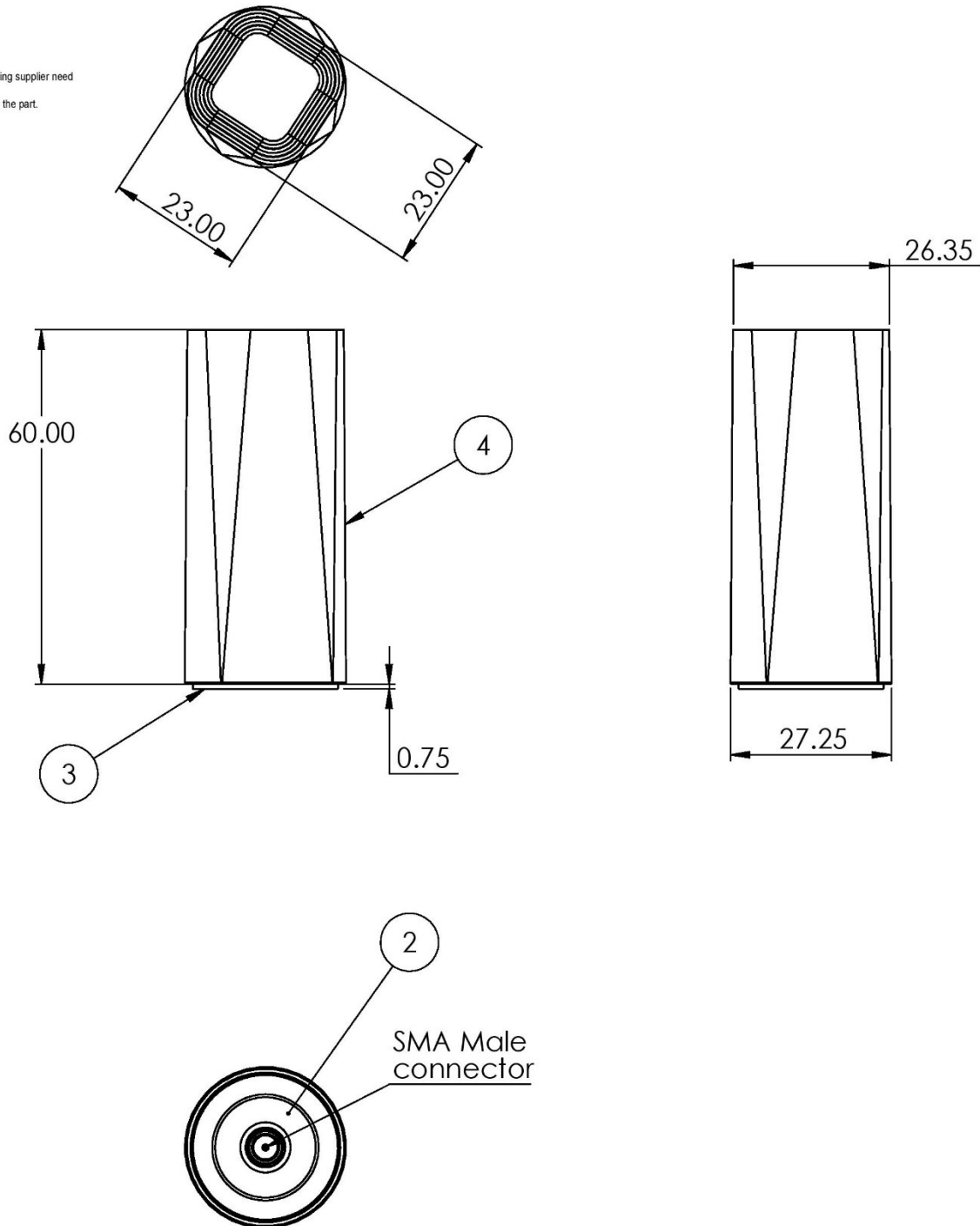

ITEM NO.	DESCRIPTION	QTY.
2	BOTTOM AND CONNECTOR	1
3	RUBBER GASKET	1
4	term mount helix housig REV 3	1

7. Installation Guide

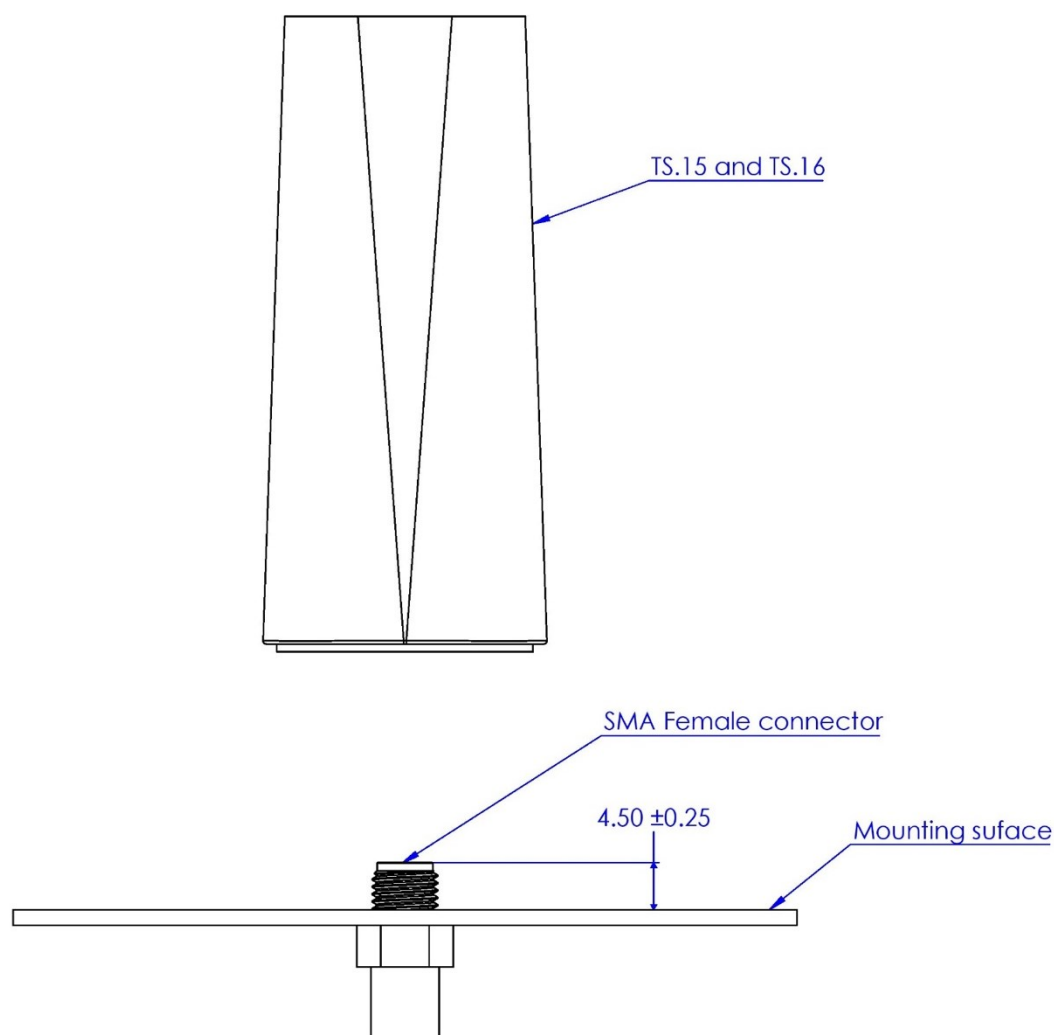

Hand-tighten only. The bottom rubber gasket must fully seat to ensure a watertight seal.

The TS.15 and TS.16 do not require a ground plane; they can be mounted to a bulkhead-mount SMA with a cable, or on a board-edge SMA at a right angle to a PCB. It should not be placed directly in the middle of a large (>15cm) ground plane, as this could degrade the axial ratio performance.

8. Packaging

1 pc TS.15.0111 per small pe bag



50 pcs TS.15.0111 per large pe bag



300 pcs TS.15.0111 per carton
Carton dimensions: 370x370x300mm

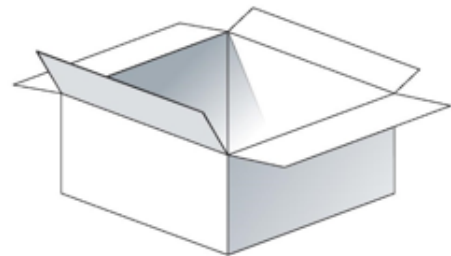

Changelog for the datasheet

SPE-24-8-022 – TS.15.0111

Revision: B (Current Version)

Date:	2024-04-17
Notes:	Added Field Test Results
Author:	Gary West

Previous Revisions

Revision: A (Original First Release)

Date:	2024-01-31
Notes:	Initial Release
Author:	Gary West



www.taoglas.com

