



Film Capacitors - Power Electronic Capacitors

PEC MKP DC

Series/Type:	MKP DC (Resin top)
Ordering code:	B25690
Date:	April 2026
Version:	3

Rated capacitance: 50 μ F ... 5500 μ F
Rated DC Voltage: 700 V DC ... 3000 V DC

Construction

- Metallized polypropylene film
- Aluminum case and resin top
- Filling material: Non-PCB hard polyurethane resin (dry type)
- Diameter: 75 mm, 85 mm, 100 mm, 116 mm, 136 mm



Features

- Operating temperature range up to 85 °C
- Self-healing properties
- Low dissipation factor
- Naturally air cooled (or forced air cooling)
- IP00 Protection Degree (Indoor Mounting)
- Over-voltage capability
- RoHS compatible
- UL 810 certified, file No. E502394

Application

- DC link for renewable energy converters (solar, wind)
- DC link for traction applications (train, subway, tramway, light train inverters)
- DC link for industrial motor drive

Terminals

- Screw female (M6) terminals

Mounting

- Threaded bolt at the bottom of aluminum case (M12)

Packing

- 75/85/100 mm Diameter: 4 capacitors per box or 12 capacitors per box
- 116/136 mm Diameter: 4 capacitors per box
- Each carton box may contain carton plates to fill the empty space.

Technical data

Rated capacitance C_R	Up to 5.5 mF
Standard capacitance tolerance	K: $\pm 10\%$
Rated DC voltage $V_{R,DC}$	700 ... 3000 V DC
Lifetime expectancy $t_{LD(\infty)}$ ¹⁾ (refer to section 3)	100 000 h at $T_{HS} +75$ °C and $V_{R,DC}$ for $\varnothing D \leq 116$ mm 100 000 h at $T_{HS} +70$ °C and $V_{R,DC}$ for $\varnothing D = 136$ mm up to 200 000 h (Considering deratings in voltage and/or temperature upon request)
Expected failure rate $\alpha_{FQ,(\infty)}$ ¹⁾	50 FIT at $V_{R,DC}$ and $+70$ °C (refer to section 4)
Frequency range	100 Hz ... 10 kHz for $C_R \leq 1500$ μ F 100 Hz ... 5 kHz for 1500 μ F $< C_R \leq 3000$ μ F 100 Hz ... 3 kHz for 3000 μ F $< C_R \leq 5500$ μ F High frequency designs available upon request Permitted I_{max} of specified frequency must be evaluated by customer
Maximum altitude	2000 m above sea level. Derating curves for altitudes higher than 2000 m available upon request
Partial discharge extinction voltage (typical)	>1.6 kV AC (10 pC) (higher value upon request)
Reference standards	IEC 61071-2017, GB/T 17702-2021, RoHS, UL 810-5 th
Maximum ratings	
Maximum permissible voltage (V_{max})	$V_{R,DC} +10\%$ (30 % of on-load daily duration) $V_{R,DC} +15\%$ (up to 30 min daily) $V_{R,DC} +20\%$ (up to 5 min daily) $V_{R,DC} +30\%$ (up to 1 min daily)
Test data	
Voltage test between terminals V_{TT}	$1.5 V_{R,DC}$, 10 s
Voltage test between terminals and case V_{TC}	4000 V AC / 10 s for $V_{R,DC} \leq 2000$ VDC 5000 V AC / 10 s for 2200 VDC $\leq V_{R,DC} \leq 2800$ VDC 5250 V AC / 10 s for $V_{R,DC} = 3000$ VDC
Climatic data	
Climatic category	40/85/56 for $75 \leq \varnothing D \leq 100$ mm 40/75/56 for $116 \leq \varnothing D \leq 136$ mm
Lower category T_{min}	-40 °C
Upper category T_{max}	+85 °C ($75 \leq \varnothing D \leq 100$), +75 °C ($116 \leq \varnothing D \leq 136$)
Damp heat test	56 days 93 % RH @ 40 °C
Maximum hotspot temperature T_{HS} (see Terms)	+85 °C ($75 \leq \varnothing D \leq 100$), +75 °C ($116 \leq \varnothing D \leq 136$)
Mechanical data	
Max. torque terminal	5 Nm for female M6, 6 Nm for female M8
Max. torque (M12) case stud	10 Nm

¹⁾ co: Continuous operation

1.1 Electrical characteristics
 $V_{R,DC} = 700 \text{ V DC} / V_{TT} = 1050 \text{ V DC}, 10 \text{ s} / V_{TC} = 4000 \text{ V AC}, 10 \text{ s}$

C_R μF	$I_{\text{max}}^{2)}$ A	\hat{I}_S kA	\hat{I} kA	ESR ³⁾ m Ω	L_{self} nH	R_{th} K/W	$\varnothing D$ mm	$H_c^{4)}$ mm	H_t mm	Weight ⁵⁾ kg	Fig. ⁶⁾	Ordering code
335	70	6.3	2.1	1.6	≤40	5.5	75	95	101	0.5	1	B25690F0347K701
455	65	6.3	2.1	2.1	≤40	4.6	75	120	126	0.6	1	B25690F0467K701
465	70	8.8	2.9	1.6	≤40	5.0	85	95	101	0.6	1	B25690F0477K701
490	70	11.0	3.7	1.5	≤40	4.2	75	154	160	0.8	1	B25690F0497K701
585	70	11.1	3.7	1.7	≤60	4.2	75	176	182	0.9	1	B25690F0597K701
635	70	8.8	2.9	2.0	≤40	4.7	85	120	126	0.8	1	B25690F0647K701
665	70	12.6	4.2	1.4	≤40	4.6	100	95	101	0.9	2	B25690F0677K701
700	70	15.7	5.2	1.5	≤40	4.3	85	154	160	1.0	1	B25690F0707K701
740	70	8.9	3.0	2.2	≤40	4.6	85	135	141	0.9	1	B25690F0747K701
775	70	8.9	3.0	2.0	≤40	4.5	85	140	146	0.9	1	B25690F0787K701
835	70	15.8	5.3	1.5	≤60	4.2	85	176	182	1.1	1	B25690F0847K701
910	70	12.6	4.2	1.5	≤40	4.2	100	120	126	1.1	2	B25690F0917K701
960	80	18.2	6.1	0.7	≤40	5.3	116	96	102	1.1	3	B25690F0967K703
1020	70	22.9	7.6	1.0	≤40	3.4	100	154	160	1.4	2	B25690F0108K701
1055	70	12.6	4.2	1.9	≤40	3.9	100	135	141	1.2	2	B25690F0118K701
1100	70	12.6	4.2	1.9	≤40	3.8	100	140	146	1.2	2	B25690F0118K711
1215	70	23.0	7.7	1.1	≤60	3.1	100	176	182	1.5	2	B25690F0128K701
1290	70	15.8	5.3	1.4	≤90	3.2	85	251	257	1.6	1	B25690F0138K701
1310	80	18.2	6.1	1.0	≤40	4.9	116	121	127	1.4	3	B25690F0138K703
1495	100	33.6	11.2	1.0	≤60	3.5	116	154	160	1.8	3	B25690F0158K703
1515	80	18.2	6.1	1.1	≤40	4.8	116	136	142	1.6	3	B25690F0158K713
1585	80	18.2	6.1	1.1	≤40	4.8	116	141	147	1.6	3	B25690F0168K703
1780	100	33.7	11.2	1.0	≤60	3.3	116	176	182	2.1	3	B25690F0188K703
2420	100	33.6	11.2	0.9	≤90	2.6	116	226	232	2.6	3	B25690F0248K703
4400	100	68.4	22.8	0.8	≤90	2.0	136	300	306	4.7	4	B25690G0448K703
5000	100	66.0	22.0	0.7	≤90	1.8	136	345	351	5.3	4	B25690G0508K703
5500	100	67.5	22.5	0.7	≤90	1.6	136	368	374	5.7	4	B25690G0558K703

²⁾ Please refer to section 2 (current derating) for more information.

³⁾ ESR at 1 kHz (typical value).

⁴⁾ H_c is a typical value.

⁵⁾ Weight is a typical value.

⁶⁾ Refer to dimensional drawings on page 16 and 17.

Other configurations and capacitance tolerances available upon request.

$V_{R,DC} = 900 \text{ V DC} / V_{TT} = 1350 \text{ V DC}, 10 \text{ s} / V_{TC} = 4000 \text{ V AC}, 10 \text{ s}$

C_R μF	$I_{max}^{2)}$ A	\hat{I}_s kA	\hat{I} kA	ESR ³⁾ m Ω	L_{self} nH	R_{th} K/W	\varnothing mm	$H_c^{4)}$ mm	H_t mm	Weight ⁵⁾ kg	Fig. ⁶⁾	Ordering code
270	65	5.7	1.9	2.1	≤40	5.5	75	95	101	0.5	1	B25690F0277K901
365	60	5.7	1.9	2.7	≤40	4.6	75	120	126	0.6	1	B25690F0377K901
380	70	8.0	2.7	1.7	≤40	5.0	85	95	101	0.6	1	B25690A0387K901
395	70	9.9	3.3	1.8	≤40	4.2	75	154	160	0.8	1	B25690F0407K901
470	70	9.9	3.3	1.9	≤60	4.2	75	176	182	0.9	1	B25690F0477K901
510	70	7.9	2.6	2.2	≤40	4.7	85	120	126	0.8	1	B25690F0517K901
535	70	11.3	3.8	1.5	≤40	4.6	100	95	101	0.9	2	B25690F0547K901
565	70	14.2	4.7	1.5	≤40	4.3	85	154	160	1.0	1	B25690F0577K901
595	65	8.0	2.7	2.3	≤40	4.6	85	135	141	0.9	1	B25690F0607K901
620	65	7.9	2.6	2.5	≤40	4.5	85	140	146	0.9	1	B25690F0627K901
730	70	14.6	4.9	1.6	≤60	4.2	85	176	182	1.1	1	B25690A0737K901
730	70	11.3	3.8	1.7	≤40	4.2	100	120	126	1.1	2	B25690F0737K901
770	80	16.2	5.4	1.0	≤40	5.3	116	96	102	1.1	3	B25690F0777K903
820	70	20.6	6.9	1.2	≤40	3.4	100	154	160	1.4	2	B25690F0827K901
845	70	11.3	3.8	1.9	≤40	3.9	100	135	141	1.2	2	B25690F0857K901
885	70	11.3	3.8	2.1	≤40	3.8	100	140	146	1.2	2	B25690F0897K901
975	70	20.6	6.9	1.2	≤60	3.1	100	176	182	1.5	2	B25690F0987K901
1035	70	14.2	4.7	1.4	≤90	3.2	85	251	257	1.6	1	B25690F0108K901
1050	80	16.3	5.4	1.3	≤40	4.9	116	121	127	1.4	3	B25690F0118K903
1205	100	30.2	10.1	1.0	≤60	3.5	116	154	160	1.8	3	B25690F0128K903
1220	80	16.3	5.4	1.5	≤40	4.8	116	136	142	1.6	3	B25690F0128K913
1275	80	16.3	5.4	1.5	≤40	4.8	116	141	147	1.6	3	B25690F0138K903
1430	100	30.2	10.1	1.3	≤60	3.3	116	176	182	2.1	3	B25690F0148K903
1950	100	30.2	10.1	1.2	≤90	2.6	116	226	232	2.6	3	B25690F0208K903
3400	100	58.9	19.6	1.2	≤90	2.0	136	300	306	4.7	4	B25690G0348K903
3800	100	55.9	18.6	1.1	≤90	1.8	136	345	351	5.3	4	B25690G0388K903
4300	100	58.8	19.6	1.0	≤90	1.6	136	368	374	5.7	4	B25690G0438K903

²⁾ Please refer to section 2 (current derating) for more information.

³⁾ ESR at 1 kHz (typical value).

⁴⁾ H_c is a typical value.

⁵⁾ Weight is a typical value.

⁶⁾ Refer to dimensional drawings on page 16 and 17.

Other configurations and capacitance tolerances available upon request.

$V_{R,DC} = 1000 \text{ V DC} / V_{TT} = 1500 \text{ V DC}, 10 \text{ s} / V_{TC} = 4000 \text{ V AC}, 10 \text{ s}$

C_R μF	$I_{max}^{2)}$ A	\hat{I}_s kA	\hat{I} kA	ESR ³⁾ m Ω	L_{self} nH	R_{th} K/W	\varnothing mm	$H_c^{4)}$ mm	H_t mm	Weight ⁵⁾ kg	Fig. ⁶⁾	Ordering code
220	60	5.1	1.7	2.2	≤40	5.5	75	95	101	0.5	1	B25690F1227K001
300	55	5.1	1.7	2.9	≤40	4.6	75	120	126	0.6	1	B25690F1307K001
305	70	7.1	2.4	1.8	≤40	5.0	85	95	101	0.6	1	B25690F1317K001
320	70	8.9	3.0	1.9	≤40	4.2	75	154	160	0.8	1	B25690F1327K001
385	70	9.0	3.0	2.0	≤60	4.2	75	176	182	0.9	1	B25690F1397K001
420	65	7.2	2.4	2.3	≤40	4.7	85	120	126	0.8	1	B25690F1427K001
440	70	10.3	3.4	1.5	≤40	4.6	100	95	101	0.9	2	B25690F1447K001
460	70	12.8	4.3	1.6	≤40	4.3	85	154	160	1.0	1	B25690F1467K001
485	65	7.2	2.4	2.2	≤40	4.6	85	135	141	0.9	1	B25690F1497K001
510	60	7.2	2.4	2.6	≤40	4.5	85	140	146	0.9	1	B25690F1517K001
550	70	12.8	4.3	1.7	≤60	4.2	85	176	182	1.1	1	B25690F1557K001
595	70	10.2	3.4	1.8	≤40	4.2	100	120	126	1.1	2	B25690F1607K001
630	80	14.7	4.9	1.0	≤40	5.3	116	96	102	1.1	3	B25690F1637K003
670	70	18.6	6.2	1.1	≤40	3.4	100	154	160	1.4	2	B25690F1677K001
695	70	10.3	3.4	1.9	≤40	3.9	100	135	141	1.2	2	B25690F1707K001
725	70	10.2	3.4	1.9	≤40	3.8	100	140	146	1.2	2	B25690F1737K001
800	70	18.6	6.2	1.1	≤60	3.1	100	176	182	1.5	2	B25690F1807K001
850	70	12.9	4.3	1.3	≤90	3.2	85	251	257	1.6	1	B25690F1857K001
860	80	14.7	4.9	1.4	≤40	4.9	116	121	127	1.4	3	B25690F1867K003
985	100	27.3	9.1	1.0	≤60	3.5	116	154	160	1.8	3	B25690F1997K003
1000	80	14.8	4.9	1.5	≤40	4.8	116	136	142	1.6	3	B25690F1108K003
1045	80	14.8	4.9	1.5	≤40	4.8	116	141	147	1.6	3	B25690F1108K013
1170	100	27.3	9.1	1.2	≤60	3.3	116	176	182	2.1	3	B25690F1128K003
1595	100	27.3	9.1	0.9	≤90	2.6	116	226	232	2.6	3	B25690F1168K003
2700	100	51.7	17.2	0.9	≤90	2.0	136	300	306	4.7	4	B25690G1278K003
3100	100	50.4	16.8	0.8	≤90	1.8	136	345	351	5.3	4	B25690G1318K003
3500	100	52.9	17.6	0.8	≤90	1.6	136	368	374	5.7	4	B25690G1358K003

²⁾ Please refer to section 2 (current derating) for more information.

³⁾ ESR at 1 kHz (typical value).

⁴⁾ H_c is a typical value.

⁵⁾ Weight is a typical value.

⁶⁾ Refer to dimensional drawings on page 16 and 17.

Other configurations and capacitance tolerances available upon request.

$V_{R,DC} = 1100 \text{ V DC} / V_{TT} = 1650 \text{ V DC, 10 s} / V_{TC} = 4000 \text{ V AC, 10 s}$

C_R μF	$I_{max}^{2)}$ A	\hat{I}_s kA	\hat{I} kA	ESR ³⁾ m Ω	L_{self} nH	R_{th} K/W	\varnothing mm	$H_c^{4)}$ mm	H_t mm	Weight ⁵⁾ kg	Fig. ⁶⁾	Ordering code
180	60	6.2	2.1	2.3	≤40	5.5	75	95	101	0.5	1	B25690F1187K101
245	55	6.2	2.1	3.0	≤40	4.6	75	120	126	0.6	1	B25690F1257K101
255	70	8.7	2.9	1.9	≤40	5.0	85	95	101	0.6	1	B25690F1267K101
265	70	10.8	3.6	2.0	≤40	4.2	75	154	160	0.8	1	B25690F1277K101
300	55	6.2	2.1	3.4	≤40	4.5	75	140	146	0.7	1	B25690F1307K101
315	70	10.8	3.6	2.1	≤60	4.2	75	176	182	0.9	1	B25690F1327K101
345	65	8.7	2.9	2.4	≤40	4.7	85	120	126	0.8	1	B25690F1357K101
360	70	12.3	4.1	1.7	≤40	4.6	100	95	101	0.9	1	B25690F1367K101
380	70	15.4	5.1	1.8	≤40	4.3	85	154	160	1.0	1	B25690F1387K101
455	70	15.6	5.2	1.9	≤60	4.2	85	176	182	1.1	1	B25690F1467K101
495	70	12.4	4.1	2.1	≤40	4.2	100	120	126	1.1	2	B25690F1507K101
520	80	17.8	5.9	1.1	≤40	5.3	116	96	102	1.1	2	B25690F1527K103
555	70	22.6	7.5	1.2	≤40	3.4	100	154	160	1.4	2	B25690F1567K101
570	70	12.3	4.1	2.0	≤40	3.9	100	135	141	1.2	2	B25690F1577K101
600	70	12.4	4.1	2.0	≤40	3.8	100	140	146	1.2	2	B25690F1607K101
660	70	22.6	7.5	1.2	≤60	3.1	100	176	182	1.5	2	B25690F1667K101
700	70	15.5	5.2	1.4	≤90	3.2	85	251	257	1.6	1	B25690F1707K101
710	80	17.8	5.9	1.5	≤40	4.9	116	121	127	1.4	3	B25690F1717K103
815	100	33.1	11.0	1.1	≤60	3.5	116	154	160	1.8	3	B25690F1827K103
825	75	17.9	6.0	1.6	≤40	4.8	116	136	142	1.6	3	B25690F1837K103
865	75	17.9	6.0	1.6	≤40	4.8	116	141	147	1.6	3	B25690F1877K103
965	100	33.0	11.0	1.3	≤60	3.3	116	176	182	2.1	3	B25690F1977K103
1320	100	33.1	11.0	1.2	≤90	2.6	116	226	232	2.6	3	B25690F1138K103
2200	100	61.8	20.6	1.2	≤90	2.0	136	300	306	4.7	4	B25690G1228K103
2600	100	62.0	20.7	1.1	≤90	1.8	136	345	351	5.3	4	B25690G1268K103
3000	100	66.5	22.2	1.0	≤90	1.6	136	368	374	5.7	4	B25690G1308K103

²⁾ Please refer to section 2 (current derating) for more information.

³⁾ ESR at 1 kHz (typical value).

⁴⁾ H_c is a typical value.

⁵⁾ Weight is a typical value.

⁶⁾ Refer to dimensional drawings on page 16 and 17.

Other configurations and capacitance tolerances available upon request.

$V_{R,DC} = 1200 \text{ V DC} / V_{TT} = 1800 \text{ V DC}, 10 \text{ s} / V_{TC} = 4000 \text{ V AC}, 10 \text{ s}$

C_R μF	$I_{max}^{2)}$ A	\hat{I}_s kA	\hat{I} kA	ESR ³⁾ m Ω	L_{self} nH	R_{th} K/W	\varnothing mm	$H_c^{4)}$ mm	H_t mm	Weight ⁵⁾ kg	Fig. ⁶⁾	Ordering code
150	55	5.7	1.9	2.8	≤40	5.5	75	95	101	0.5	1	B25690F1157K201
200	55	5.5	1.8	3.5	≤40	4.6	75	120	126	0.6	1	B25690F1207K201
205	65	7.7	2.6	2.2	≤40	5.0	85	95	101	0.6	1	B25690F1217K201
220	70	9.9	3.3	2.1	≤40	4.2	75	154	160	0.8	1	B25690F1227K201
260	70	9.8	3.3	2.2	≤60	4.2	75	176	182	0.9	1	B25690F1267K201
285	60	7.9	2.6	2.7	≤40	4.7	85	120	126	0.8	1	B25690F1297K201
295	70	11.1	3.7	2.0	≤40	4.6	100	95	101	0.9	2	B25690F1307K201
310	70	13.9	4.6	1.9	≤40	4.3	85	154	160	1.0	1	B25690F1317K201
330	65	7.9	2.6	2.6	≤40	4.6	85	135	141	0.9	1	B25690F1337K201
345	60	7.9	2.6	3.1	≤40	4.5	85	140	146	0.9	1	B25690F1357K201
370	70	14.0	4.7	2.0	≤60	4.2	85	176	182	1.1	1	B25690F1377K201
405	70	11.2	3.7	2.1	≤40	4.2	100	120	126	1.1	2	B25690F1417K201
425	80	16.1	5.4	1.2	≤40	5.3	116	96	102	1.1	3	B25690F1437K203
455	70	20.4	6.8	1.3	≤40	3.4	100	154	160	1.4	2	B25690F1467K201
470	70	11.2	3.7	2.3	≤40	3.9	100	135	141	1.2	2	B25690F1477K201
490	70	11.2	3.7	2.3	≤40	3.8	100	140	146	1.2	2	B25690F1497K201
540	70	20.4	6.8	1.3	≤60	3.1	100	176	182	1.5	2	B25690F1547K201
575	70	14.1	4.7	1.6	≤90	3.2	85	251	257	1.6	1	B25690F1587K201
580	75	16.1	5.4	1.7	≤40	4.9	116	121	127	1.4	3	B25690F1587K203
665	100	29.9	10.0	1.0	≤60	3.5	116	154	160	1.8	3	B25690F1677K203
675	70	16.2	5.4	1.9	≤40	4.8	116	136	142	1.6	3	B25690F1687K203
705	70	16.1	5.4	1.9	≤40	4.8	116	141	147	1.6	3	B25690F1717K203
790	100	29.8	9.9	1.3	≤60	3.3	116	176	182	2.1	3	B25690F1797K203
1080	100	30.0	10.0	1.2	≤90	2.6	116	226	232	2.6	3	B25690F1118K203
1800	100	55.9	18.6	1.2	≤90	2.0	136	300	306	4.7	4	B25690G1188K203
2100	100	58.3	19.4	1.1	≤90	1.8	136	345	351	5.3	4	B25690C1218K203
2400	100	58.8	19.6	1.0	≤90	1.6	136	368	374	5.7	4	B25690G1248K203

²⁾ Please refer to section 2 (current derating) for more information.

³⁾ ESR at 1 kHz (typical value).

⁴⁾ H_c is a typical value.

⁵⁾ Weight is a typical value.

⁶⁾ Refer to dimensional drawings on page 16 and 17.

Other configurations and capacitance tolerances available upon request.

$V_{R,DC} = 1300 \text{ V DC} / V_{TT} = 1950 \text{ V DC}, 10 \text{ s} / V_{TC} = 4000 \text{ V AC}, 10 \text{ s}$

C_R μF	$I_{max}^{2)}$ A	\hat{I}_s kA	\hat{I} kA	ESR ³⁾ m Ω	L_{self} nH	R_{th} K/W	\varnothing mm	$H_c^{4)}$ mm	H_t mm	Weight ⁵⁾ kg	Fig. ⁶⁾	Ordering code
120	55	5.2	1.7	3.0	≤40	5.5	75	95	101	0.5	1	B25690F1127K301
165	50	5.2	1.7	3.8	≤40	4.6	75	120	126	0.6	1	B25690F1177K301
165	65	7.1	2.4	2.3	≤40	5.0	85	95	101	0.6	1	B25690F1177K311
175	70	9.0	3.0	2.2	≤40	4.2	75	154	160	0.8	1	B25690F1187K301
210	70	9.0	3.0	2.4	≤60	4.2	75	176	182	0.9	1	B25690F1217K301
230	60	7.2	2.4	2.9	≤40	4.7	85	120	126	0.8	1	B25690F1237K301
240	70	10.3	3.4	1.9	≤40	4.6	100	95	101	0.9	2	B25690F1247K301
250	70	12.9	4.3	1.9	≤40	4.3	85	154	160	1.0	1	B25690F1257K301
270	60	7.2	2.4	2.9	≤40	4.6	85	135	141	0.9	1	B25690F1277K301
280	55	7.2	2.4	3.4	≤40	4.5	85	140	146	0.9	1	B25690F1287K301
300	70	12.9	4.3	2.0	≤60	4.2	85	176	182	1.1	1	B25690F1307K301
330	65	10.3	3.4	2.2	≤40	4.2	100	120	126	1.1	2	B25690F1337K301
345	80	14.8	4.9	1.3	≤40	5.3	116	96	102	1.1	3	B25690F1357K303
360	70	18.6	6.2	1.3	≤40	3.4	100	154	160	1.4	2	B25690F1367K301
385	65	10.3	3.4	2.4	≤40	3.9	100	135	141	1.2	2	B25690F1397K301
400	65	10.2	3.4	2.4	≤40	3.8	100	140	146	1.2	2	B25690F1407K301
435	70	18.7	6.2	1.4	≤60	3.1	100	176	182	1.5	2	B25690F1447K301
470	70	12.9	4.3	1.6	≤90	3.2	85	251	257	1.6	1	B25690F1477K301
475	75	14.8	4.9	1.7	≤40	4.9	116	121	127	1.4	3	B25690F1487K303
530	100	27.3	9.1	1.1	≤60	3.5	116	154	160	1.8	3	B25690F1537K303
555	70	14.9	5.0	1.9	≤40	4.8	116	136	142	1.6	3	B25690F1567K303
580	70	14.9	5.0	1.9	≤40	4.8	116	141	147	1.6	3	B25690F1587K303
640	100	27.5	9.2	1.3	≤60	3.3	116	176	182	2.1	3	B25690F1647K303
880	100	27.5	9.2	1.2	≤90	2.6	116	226	232	2.6	3	B25690F1887K303
1500	100	52.6	17.5	1.2	≤90	2.0	136	300	306	4.7	4	B25690G1158K303
1700	100	50.3	16.8	1.1	≤90	1.8	136	345	351	5.3	4	B25690G1178K303
1900	100	52.2	17.4	1.0	≤90	1.6	136	368	374	5.7	4	B25690G1198K303

²⁾ Please refer to section 2 (current derating) for more information.

³⁾ ESR at 1 kHz (typical value).

⁴⁾ H_c is a typical value.

⁵⁾ Weight is a typical value.

⁶⁾ Refer to dimensional drawings on page 16 and 17.

Other configurations and capacitance tolerances available upon request.

$V_{R,DC} = 1500 \text{ V DC} / V_{TT} = 2250 \text{ V DC}, 10 \text{ s} / V_{TC} = 4000 \text{ V AC}, 10 \text{ s}$

C_R μF	$I_{max}^{2)}$ A	\hat{I}_s kA	\hat{I} kA	ESR ³⁾ m Ω	L_{self} nH	R_{th} K/W	$\varnothing D$ mm	$H_c^{4)}$ mm	H_t mm	Weight ⁵⁾ kg	Fig. ⁶⁾	Ordering code
100	50	4.6	1.5	3.4	≤40	5.5	75	95	101	0.5	1	B25690F1107K501*
140	50	4.7	1.6	4.5	≤40	4.6	75	120	126	0.6	1	B25690F1147K501*
140	60	6.5	2.2	2.7	≤40	5.0	85	95	101	0.6	1	B25690F1147K511*
150	65	8.4	2.8	2.5	≤40	4.2	75	154	160	0.8	1	B25690F1157K501*
195	55	6.6	2.2	3.4	≤40	4.7	85	120	126	0.8	1	B25690F1207K501*
205	70	9.5	3.2	2.0	≤40	4.6	100	95	101	0.9	2	B25690F1217K501*
215	70	12.0	4.0	2.1	≤40	4.3	85	154	160	1.0	1	B25690F1227K501*
230	60	6.7	2.2	2.7	≤40	4.6	85	135	141	0.9	1	B25690F1237K501*
240	60	6.6	2.2	3.1	≤40	4.5	85	140	146	0.9	1	B25690F1247K501*
255	70	11.8	3.9	2.2	≤60	4.2	85	176	182	1.1	1	B25690F1267K501*
280	65	9.4	3.1	2.4	≤40	4.2	100	120	126	1.1	2	B25690F1287K501*
295	80	13.7	4.6	1.5	≤40	5.3	116	96	102	1.1	3	B25690F1307K503*
310	70	17.3	5.8	1.4	≤40	3.4	100	154	160	1.4	2	B25690F1317K501*
330	65	9.6	3.2	2.6	≤40	3.9	100	135	141	1.2	2	B25690F1337K501*
370	70	17.2	5.7	1.4	≤60	3.1	100	176	182	1.5	2	B25690F1377K501
400	70	11.9	4.0	1.6	≤90	3.2	85	251	257	1.6	1	B25690F1407K501
405	70	13.7	4.6	2.0	≤40	4.9	116	121	127	1.4	3	B25690F1417K503*
455	100	25.4	8.5	1.2	≤60	3.5	116	154	160	1.8	3	B25690F1467K503
475	70	13.8	4.6	2.2	≤40	4.8	116	136	142	1.6	3	B25690F1487K503*
495	70	13.7	4.6	2.2	≤40	4.8	116	141	147	1.6	3	B25690F1507K503*
545	90	25.3	8.4	1.4	≤60	3.3	116	176	182	2.1	3	B25690F1557K503
755	100	25.5	8.5	1.1	≤90	2.6	116	226	232	2.6	3	B25690F1767K503
1200	100	45.5	15.2	1.2	≤90	2.0	136	300	306	4.7	4	B25690G1128K503
1400	100	44.8	14.9	1.2	≤90	1.8	136	345	351	5.3	4	B25690G1148K503
1600	100	47.5	15.8	1.0	≤90	1.6	136	368	374	5.7	4	B25690G1168K503

²⁾ Please refer to section 2 (current derating) for more information.

³⁾ ESR at 1 kHz (typical value).

⁴⁾ H_c is a typical value.

⁵⁾ Weight is a typical value.

⁶⁾ Refer to dimensional drawings on page 16 and 17.

Other configurations and capacitance tolerances available upon request.

*** This ordering code is affected by "Dual Use" regulations according to Export Control law. Deliveries of such products are subject to prior approval by Export Control authorities based on customer declarations. The delivery to certain countries might be restricted.**

$V_{R,DC} = 1700 \text{ V DC} / V_{TT} = 2550 \text{ V DC}, 10 \text{ s} / V_{TC} = 4000 \text{ V AC}, 10 \text{ s}$

C_R μF	$I_{max}^{2)}$ A	\hat{I}_s kA	\hat{I} kA	ESR ³⁾ m Ω	L_{self} nH	R_{th} K/W	$\varnothing D$ mm	$H_c^{4)}$ mm	H_t mm	Weight ⁵⁾ kg	Fig. ⁶⁾	Ordering code
175	50	5.7	1.9	3.3	≤40	4.5	85	140	146	0.9	1	B25690F1187K701*
255	80	10.1	3.4	1.8	≤60	3.8	85	226	232	1.4	1	B25690F1267K701
295	70	11.6	3.9	2.1	≤40	4.9	116	121	127	1.4	3	B25690F1307K703*
360	70	11.7	3.9	2.2	≤40	4.8	116	141	147	1.6	3	B25690F1367K703*
400	100	21.8	7.3	1.2	≤60	3.3	116	176	182	2.1	3	B25690F1407K703
415	80	16.4	5.5	1.8	≤40	3.0	136	121	127	1.9	4	B25690G1427K703*
505	80	16.4	5.5	2.0	≤40	2.8	136	141	147	2.2	4	B25690G1517K703*
550	100	21.7	7.2	1.3	≤90	2.6	116	226	232	2.6	3	B25690F1557K703
565	100	30.7	10.2	1.1	≤60	2.5	136	176	182	2.7	4	B25690G1577K703
780	100	30.8	10.3	1.2	≤90	2.2	136	226	232	3.5	4	B25690G1787K703
950	100	30.8	10.3	1.3	≤90	2.0	136	266	272	4.1	4	B25690G1957K703
1100	100	41.2	13.7	1.1	≤90	1.8	136	345	351	5.3	4	B25690G1118K703
1200	100	41.7	13.9	1.0	≤90	1.6	136	368	374	5.7	4	B25690G1128K703

 $V_{R,DC} = 2000 \text{ V DC} / V_{TT} = 3000 \text{ V DC}, 10 \text{ s} / V_{TC} = 4000 \text{ V AC}, 10 \text{ s}$

125	50	4.8	1.6	3.6	≤40	4.5	85	140	146	0.9	1	B25690F2137K001*
185	80	8.6	2.9	1.9	≤60	3.8	85	226	232	1.4	1	B25690F2197K001
210	70	9.8	3.3	2.2	≤40	4.9	116	121	127	1.4	3	B25690F2217K003*
255	70	9.8	3.3	2.4	≤40	4.8	116	141	147	1.6	3	B25690F2267K003*
285	100	18.4	6.1	1.2	≤60	3.3	116	176	182	2.1	3	B25690F2297K003
295	80	13.8	4.6	1.9	≤40	3.0	136	121	127	1.9	4	B25690G2307K003*
360	80	13.8	4.6	2.1	≤40	2.8	136	141	147	2.2	4	B25690G2367K003*
390	100	18.2	6.1	1.4	≤90	2.6	116	226	232	2.6	3	B25690F2397K003
405	100	26.1	8.7	1.1	≤60	2.5	136	176	182	2.7	4	B25690G2417K003
555	100	25.9	8.6	1.3	≤90	2.2	136	226	232	3.5	4	B25690G2567K003
680	100	26.1	8.7	1.4	≤90	2.0	136	266	272	4.1	4	B25690G2687K003
750	100	33.2	11.1	1.1	≤90	1.8	136	345	351	5.3	4	B25690G2757K003
800	100	32.9	11.0	1.0	≤90	1.6	136	368	374	5.7	4	B25690G2807K003

²⁾ Please refer to section 2 (current derating) for more information.

³⁾ ESR at 1 kHz (typical value).

⁴⁾ H_c is a typical value.

⁵⁾ Weight is a typical value.

⁶⁾ Refer to dimensional drawings on page 16 and 17.

Other configurations and capacitance tolerances available upon request.

*** This ordering code is affected by "Dual Use" regulations according to Export Control law. Deliveries of such products are subject to prior approval by Export Control authorities based on customer declarations. The delivery to certain countries might be restricted.**

$V_{R,DC} = 2200 \text{ V DC} / V_{TT} = 3300 \text{ V DC}, 10 \text{ s} / V_{TC} = 5000 \text{ V AC}, 10 \text{ s}$

C_R μF	$I_{max}^{2)}$ A	\hat{I}_s kA	\hat{I} kA	ESR ³⁾ m Ω	L_{self} nH	R_{th} K/W	$\varnothing D$ mm	$H_c^{4)}$ mm	H_t mm	Weight ⁵⁾ kg	Fig. ⁶⁾	Ordering code
99	45	4.3	1.4	3.8	≤40	4.5	85	140	146	0.9	1	B25690F2996K201*
140	80	7.5	2.5	2.0	≤60	3.8	85	226	232	1.4	1	B25690F2147K201
165	70	8.9	3.0	2.3	≤40	4.9	116	121	127	1.4	3	B25690F2177K203*
200	65	8.8	2.9	2.6	≤40	4.8	116	141	147	1.6	3	B25690F2207K203*
220	100	16.6	5.5	1.2	≤60	3.3	116	176	182	2.1	3	B25690F2227K203
230	75	12.4	4.1	2.0	≤40	3.0	136	121	127	1.9	4	B25690G2237K203*
285	75	12.5	4.2	2.2	≤40	2.8	136	141	147	2.2	4	B25690G2297K203*
305	100	16.4	5.5	1.5	≤90	2.6	116	226	232	2.6	3	B25690F2317K203
310	100	23.4	7.8	1.1	≤60	2.5	136	176	182	2.7	4	B25690G2317K203
435	100	23.4	7.8	1.3	≤90	2.2	136	226	232	3.5	4	B25690G2447K203
535	100	23.5	7.8	1.5	≤90	2.0	136	266	272	4.1	4	B25690G2547K203
620	100	31.6	10.5	1.2	≤90	1.8	136	345	351	5.3	4	B25690G2627K203
670	100	31.6	10.5	1.1	≤90	1.6	136	368	374	5.7	4	B25690G2677K203

 $V_{R,DC} = 2400 \text{ V DC} / V_{TT} = 3600 \text{ V DC}, 10 \text{ s} / V_{TC} = 5000 \text{ V AC}, 10 \text{ s}$

81	45	3.9	1.3	4.0	≤40	4.5	85	140	146	0.9	1	B25690F2816K401*
115	75	6.8	2.3	2.1	≤60	3.8	85	226	232	1.4	1	B25690F2127K401
135	65	8.0	2.7	2.4	≤40	4.9	116	121	127	1.4	3	B25690F2147K403*
165	65	8.0	2.7	2.7	≤40	4.8	116	141	147	1.6	3	B25690F2177K403*
180	100	15.0	5.0	1.3	≤60	3.3	116	176	182	2.1	3	B25690F2187K403
190	75	11.3	3.8	2.1	≤40	3.0	136	121	127	1.9	4	B25690G2197K403*
230	75	11.2	3.7	2.3	≤40	2.8	136	141	147	2.2	4	B25690G2237K403*
250	100	14.9	5.0	1.5	≤90	2.6	116	226	232	2.6	3	B25690F2257K403
255	100	21.2	7.1	1.2	≤60	2.5	136	176	182	2.7	4	B25690G2267K403
355	100	21.1	7.0	1.4	≤90	2.2	136	226	232	3.5	4	B25690G2367K403
435	100	21.1	7.0	1.5	≤90	2.0	136	266	272	4.1	4	B25690G2447K403
500	100	28.2	9.4	1.3	≤90	1.8	136	345	351	5.3	4	B25690G2507K403
550	100	28.7	9.6	1.1	≤90	1.6	136	368	374	5.7	4	B25690G2557K403

²⁾ Please refer to section 2 (current derating) for more information.

³⁾ ESR at 1 kHz (typical value).

⁴⁾ H_c is a typical value.

⁵⁾ Weight is a typical value.

⁶⁾ Refer to dimensional drawings on page 16 and 17.

Other configurations and capacitance tolerances available upon request.

*** This ordering code is affected by "Dual Use" regulations according to Export Control law. Deliveries of such products are subject to prior approval by Export Control authorities based on customer declarations. The delivery to certain countries might be restricted.**

$V_{R,DC} = 2600 \text{ V DC} / V_{TT} = 3900 \text{ V DC}, 10 \text{ s} / V_{TC} = 5000 \text{ V AC}, 10 \text{ s}$

C_R μF	$I_{max}^{2)}$ A	\hat{I}_s kA	\hat{I} kA	ESR ³⁾ m Ω	L_{self} nH	R_{th} K/W	$\varnothing D$ mm	$H_c^{4)}$ mm	H_t mm	Weight ⁵⁾ kg	Fig. ⁶⁾	Ordering code
68	40	3.6	1.2	4.2	≤40	4.5	85	140	146	0.9	1	B25690F2686K601*
99	70	6.4	2.1	2.2	≤60	3.8	85	226	232	1.4	1	B25690F2996K601
110	65	7.1	2.4	2.5	≤40	4.9	116	121	127	1.4	3	B25690F2117K603*
140	65	7.4	2.5	2.8	≤40	4.8	116	141	147	1.6	3	B25690F2147K603*
145	100	13.1	4.4	1.3	≤60	3.3	116	176	182	2.1	3	B25690F2157K603
160	75	10.4	3.5	2.1	≤40	3.0	136	121	127	1.9	4	B25690G2167K603*
195	70	10.3	3.4	2.4	≤40	2.8	136	141	147	2.2	4	B25690G2207K603*
210	100	13.6	4.5	1.6	≤90	2.6	116	226	232	2.6	3	B25690F2217K603
215	100	19.5	6.5	1.2	≤60	2.5	136	176	182	2.7	4	B25690G2227K603
300	100	19.5	6.5	1.4	≤90	2.2	136	226	232	3.5	4	B25690G2307K603
365	100	19.3	6.4	1.6	≤90	2.0	136	266	272	4.1	4	B25690G2377K603
420	100	25.8	8.6	1.3	≤90	1.8	136	345	351	5.3	4	B25690G2427K603
460	100	26.1	8.7	1.1	≤90	1.6	136	368	374	5.7	4	B25690G2467K603

 $V_{R,DC} = 2800 \text{ V DC} / V_{TT} = 4200 \text{ V DC}, 10 \text{ s} / V_{TC} = 5000 \text{ V AC}, 10 \text{ s}$

58	40	3.3	1.1	4.4	≤40	4.5	85	140	146	0.9	1	B25690F2586K801*
85	70	6.0	2.0	2.3	≤60	3.8	85	226	232	1.4	1	B25690F2856K801
98	65	6.9	2.3	2.6	≤40	4.9	116	121	127	1.4	3	B25690F2986K803*
120	60	6.8	2.3	3.0	≤40	4.8	116	141	147	1.6	3	B25690F2127K803*
130	100	12.7	4.2	1.4	≤60	3.3	116	176	182	2.1	3	B25690F2137K803
135	70	9.5	3.2	2.2	≤40	3.0	136	121	127	1.9	4	B25690G2147K803*
165	70	9.4	3.1	2.5	≤40	2.8	136	141	147	2.2	4	B25690G2177K803*
180	100	12.6	4.2	1.6	≤90	2.6	116	226	232	2.6	3	B25690F2187K803
180	100	17.6	5.9	1.2	≤60	2.5	136	176	182	2.7	4	B25690G2187K803
255	100	17.9	6.0	1.4	≤90	2.2	136	226	232	3.5	4	B25690G2267K803
315	100	18.0	6.0	1.6	≤90	2.0	136	266	272	4.1	4	B25690G2327K803
360	100	23.9	8.0	1.3	≤90	1.8	136	345	351	5.3	4	B25690C2367K803
400	100	24.5	8.2	1.1	≤90	1.6	136	368	374	5.7	4	B25690G2407K803

²⁾ Please refer to section 2 (current derating) for more information.

³⁾ ESR at 1 kHz (typical value).

⁴⁾ H_c is a typical value.

⁵⁾ Weight is a typical value.

⁶⁾ Refer to dimensional drawings on page 16 and 17.

Other configurations and capacitance tolerances available upon request.

*** This ordering code is affected by "Dual Use" regulations according to Export Control law. Deliveries of such products are subject to prior approval by Export Control authorities based on customer declarations. The delivery to certain countries might be restricted.**

$V_{R,DC} = 3000 \text{ V DC} / V_{TT} = 4500 \text{ V DC}, 10 \text{ s} / V_{TC} = 5250 \text{ V AC}, 10 \text{ s}$

C_R μF	$I_{max}^{2)}$ A	\hat{I}_s kA	\hat{I} kA	ESR ³⁾ m Ω	L_{self} nH	R_{th} K/W	$\varnothing D$ mm	$H_c^{4)}$ mm	H_t mm	Weight ⁵⁾ kg	Fig. ⁶⁾	Ordering code
50	40	3.1	1.0	4.7	≤40	4.5	85	140	146	0.9	1	B25690F3506K001*
73	70	5.5	1.8	2.4	≤60	3.8	85	226	232	1.4	1	B25690F3736K001
84	60	6.3	2.1	2.7	≤40	4.9	116	121	127	1.4	3	B25690F3846K003*
100	60	6.1	2.0	3.0	≤40	4.8	116	141	147	1.6	3	B25690F3107K003*
110	95	11.6	3.9	1.4	≤60	3.3	116	176	182	2.1	3	B25690F3117K003
115	70	8.7	2.9	2.3	≤40	3.0	136	121	127	1.9	4	B25690G3127K003*
145	70	8.9	3.0	2.6	≤40	2.8	136	141	147	2.2	4	B25690G3157K003*
155	95	11.7	3.9	1.7	≤90	2.6	116	226	232	2.6	3	B25690F3167K003
155	100	16.3	5.4	1.3	≤60	2.5	136	176	182	2.7	4	B25690G3167K003
220	100	16.6	5.5	1.5	≤90	2.2	136	226	232	3.5	4	B25690G3227K003
270	100	16.6	5.5	1.7	≤90	2.0	136	266	272	4.1	4	B25690G3277K003
320	100	22.8	7.6	1.3	≤90	1.8	136	345	351	5.3	4	B25690C3327K003
330	100	21.8	7.3	1.1	≤90	1.6	136	368	374	5.7	4	B25690G3337K003

²⁾ Please refer to section 2 (current derating) for more information.

³⁾ ESR at 1 kHz (typical value).

⁴⁾ H_c is a typical value.

⁵⁾ Weight is a typical value.

⁶⁾ Refer to dimensional drawings on page 16 and 17.

Other configurations and capacitance tolerances available upon request.

*** This ordering code is affected by "Dual Use" regulations according to Export Control law. Deliveries of such products are subject to prior approval by Export Control authorities based on customer declarations. The delivery to certain countries might be restricted.**

1.2 Structure of ordering code

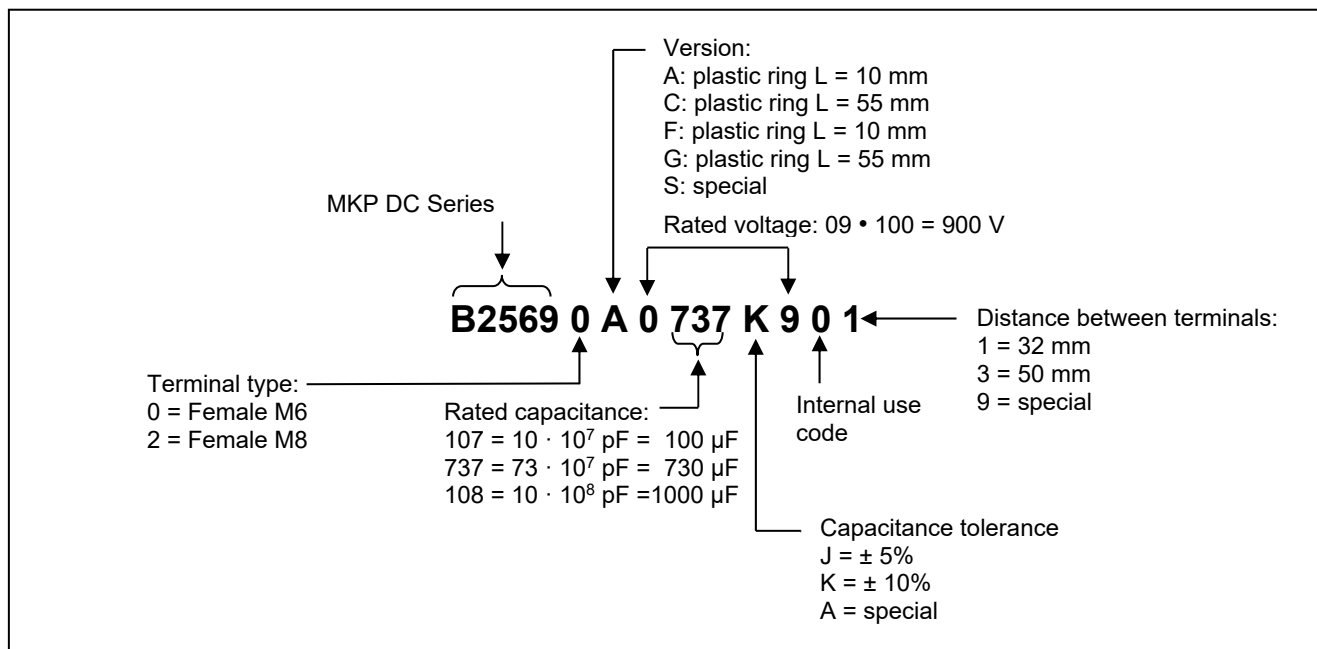

Display of ordering codes for TDK Electronics products

The ordering code for one and the same product can be represented differently in data sheets, data books, other publications, on the company website, or in order-related documents such as shipping notes, order confirmations and product labels. **The varying representations of the ordering codes are due to different processes employed and do not affect the specifications of the respective products.** Detailed information can be found on the Internet under www.tdk-electronics.tdk.com/orderingcodes.

1.3 Label Information

TDK

B25690A0737K901

730µF ±10%

$V_{RDC} = 900V$

$V_{TC} = 4kV$

-40...+85°C IEC 61071

SH-No PCB Dry Type

Max. torque of terminals: 5Nm

Discharge before handling

Made by TDK 41 Z 2024

123456789001

Date code explanation (41 Z 2024)

CW Z YYYY: production week (e.g.: CW41)
CW Z YYYY: produced in Zhuhai (China)
CW Z YYYY: production year (e.g.: 2024)

Bar code explanation

Bar code consists of batch number and serial number.
 Batch number: 9 digits (e.g.: 123456789)
 Serial number: 3 digits (e.g.: 001)

1.4 Dimensional drawings

Figure 1: - B25690A/F – ØD = 75/85 mm

- Female terminals (M6)
- Between terminals 32 ±0.5 mm

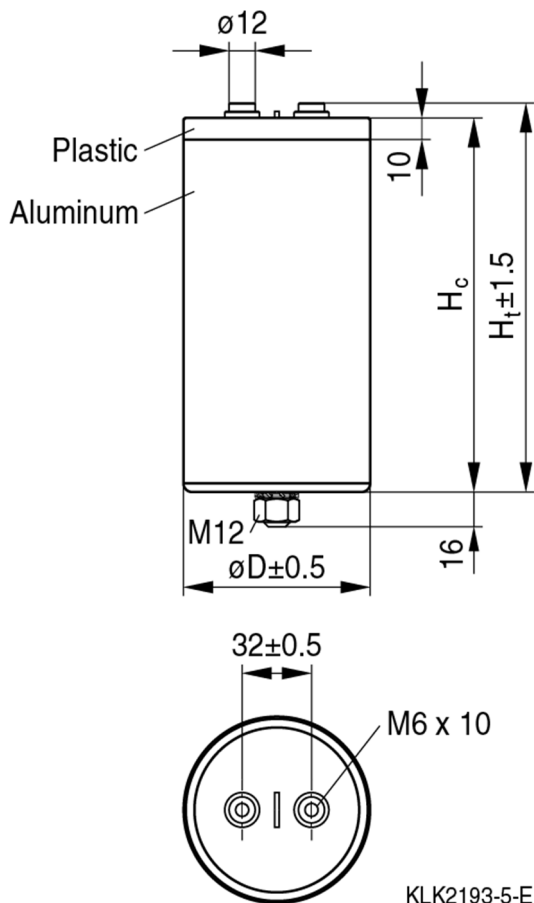
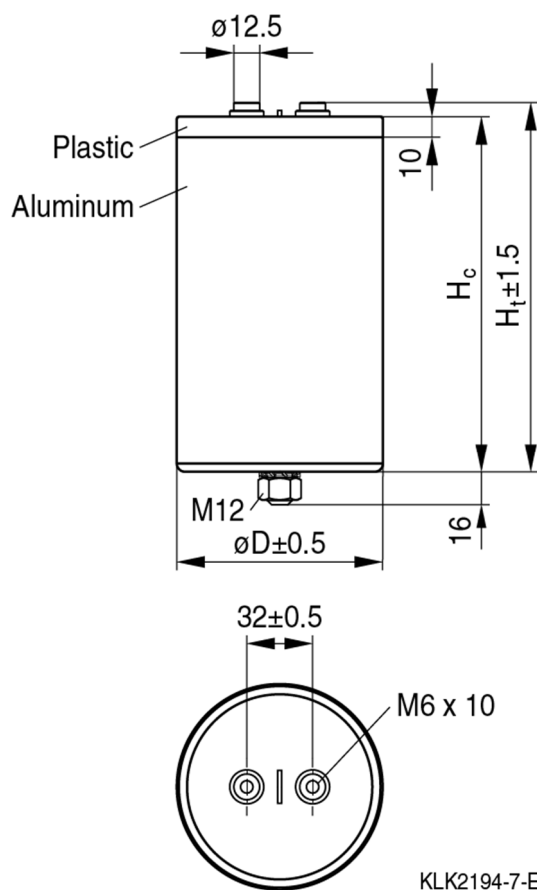

Figure 2: - B25690A/F – ØD = 100 mm

- Female terminals (M6)
- Between terminals 32 ±0.5 mm



M12 stud on bottom of the aluminum case, nut (DIN 934) and toothed lock washer (DIN 6797) for fixing are standard for all types.

ØD is the diameter which close to the aluminum case bottom side about 10 mm.

Figure 3: - B25690A/F – ØD = 116 mm

- Female terminals (M6)
- Between terminals 50 ± 0.5 mm

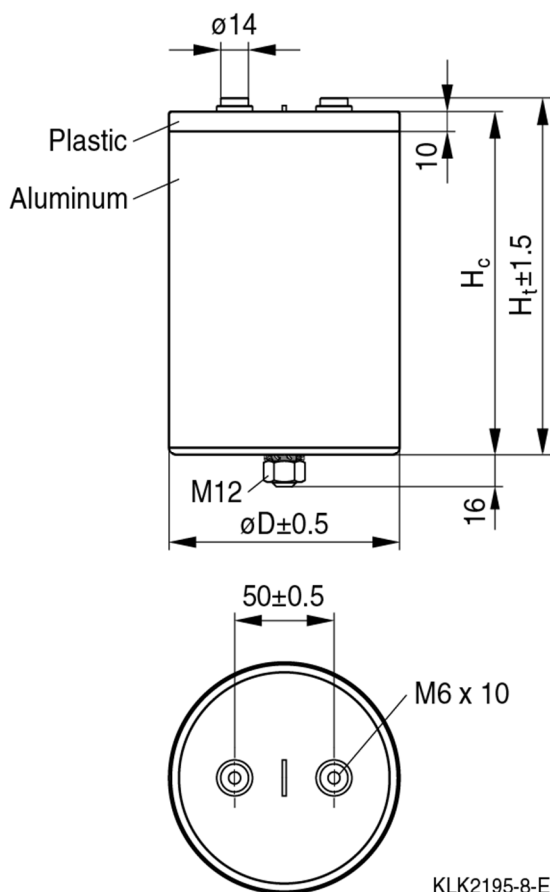
Figure 4: - B25690C/G – ØD = 136 mm

- Female terminals (M6)
- Between terminals 50 ± 0.5 mm

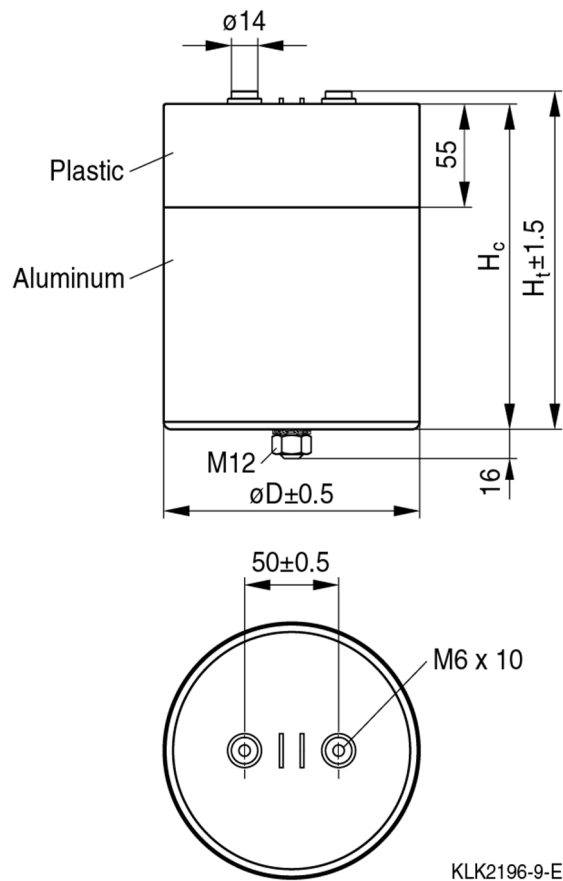

M12 stud on bottom of the aluminum case, nut (DIN 934) and toothed lock washer (DIN 6797) for fixing are standard for all types.

ØD is the diameter which close to the aluminum case bottom side about 10 mm.

1.5 Clearance and Creepage distances (Typical value)

Diameter (Ø) (mm)	Plastic ring (L) (mm)	Terminal to Terminal		Terminal to Case	
		Clearance (mm)	Creepage (mm)	Clearance (mm)	Creepage (mm)
75	10	20.0	27.5	25.5	27.0
85	10	20.0	27.5	30.5	32.0
100	10	19.5	27.0	37.5	39.0
116	10	36.0	43.5	36.0	37.5
136	55	36.0	47.5	91.0	92.5

2. Current derating

2.1 Current derating curves for capacitors $V_{R,DC} = 700\text{ VDC}$

B25690F0467K701

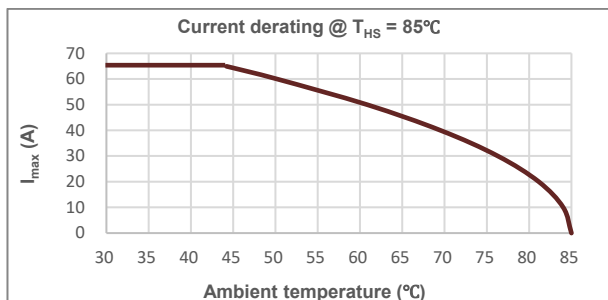

B25690F0597K701

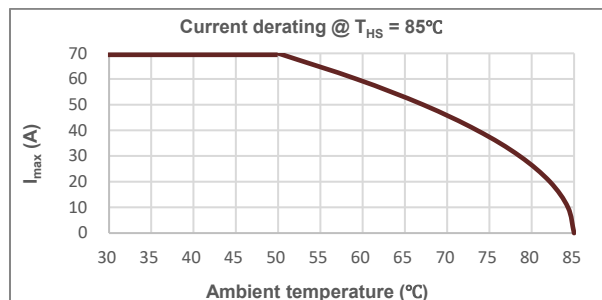

B25690F0787K701

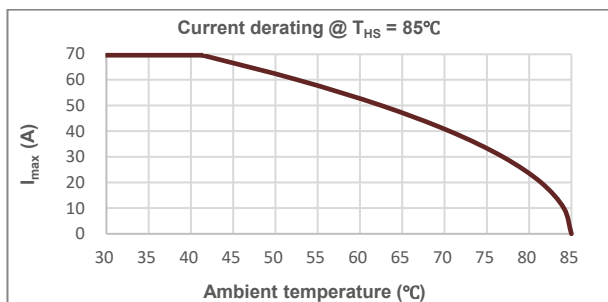

B25690F0118K701

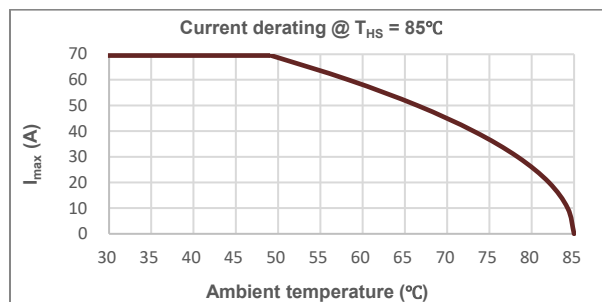

B25690F0138K701

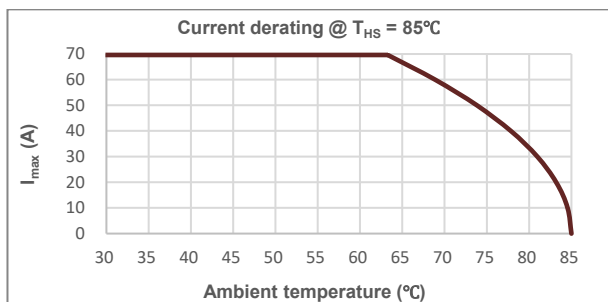

B25690F0168K703

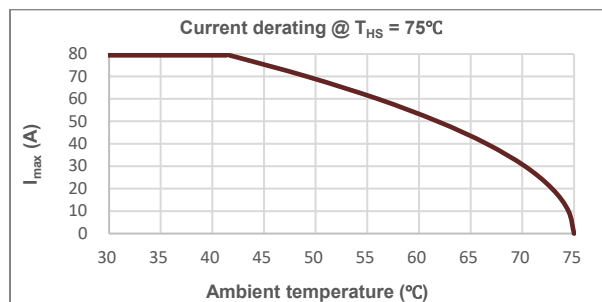

B25690F0248K703

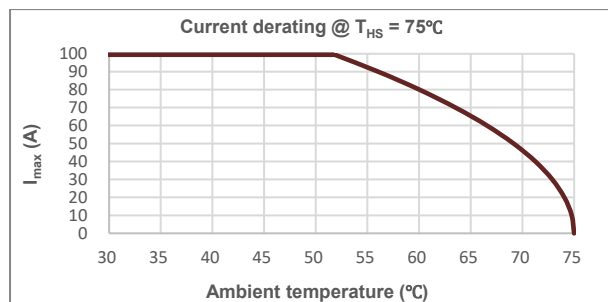

B25690G0448K703

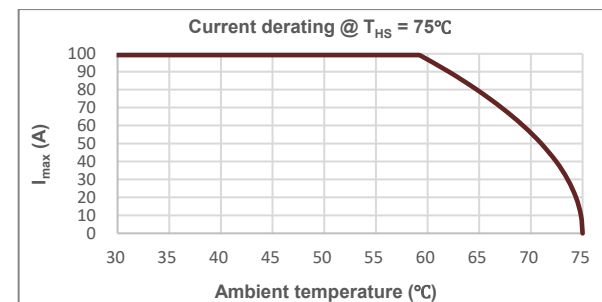

2.2 Current derating curves for capacitors $V_{R, DC} = 900$ VDC

B25690A0387K901

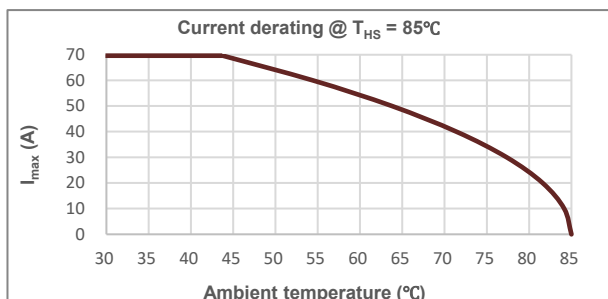

B25690F0607K901

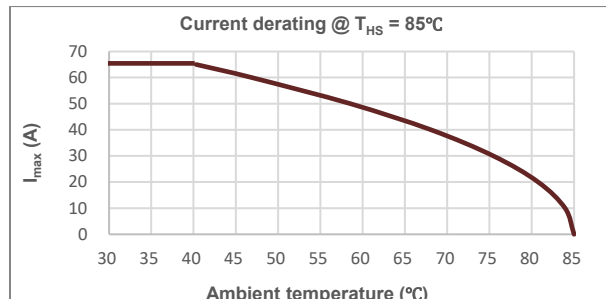

B25690F0627K901

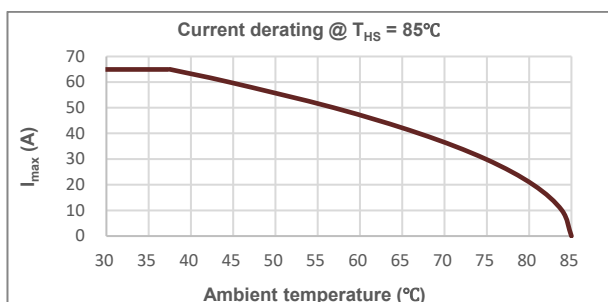

B25690A0737K901

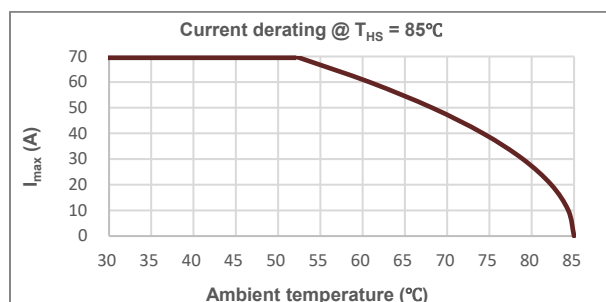

B25690F0777K903

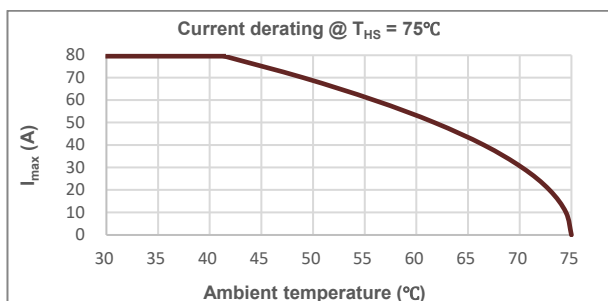

B25690F0897K901

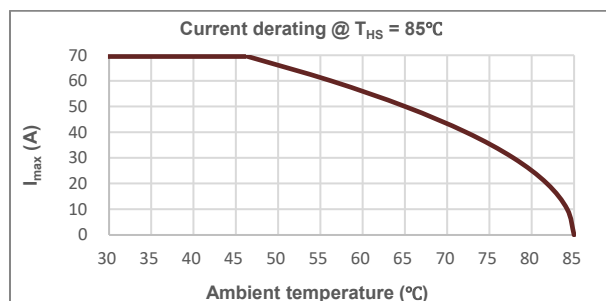

B25690F0138K903

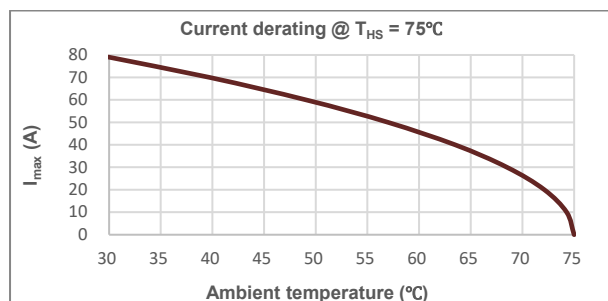

B25690F0148K903

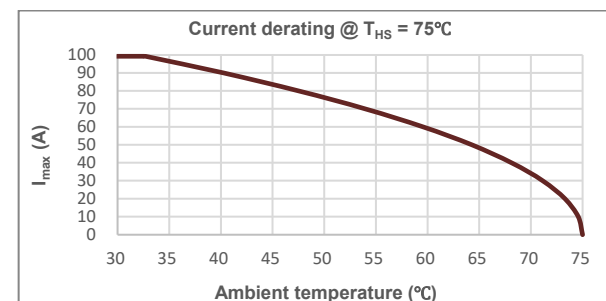

2.3 Current derating curves for capacitors $V_{R, DC} = 1100$ VDC

B25690F1257K101

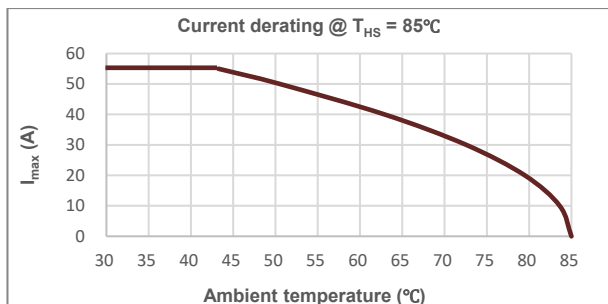

B25690F1307K101

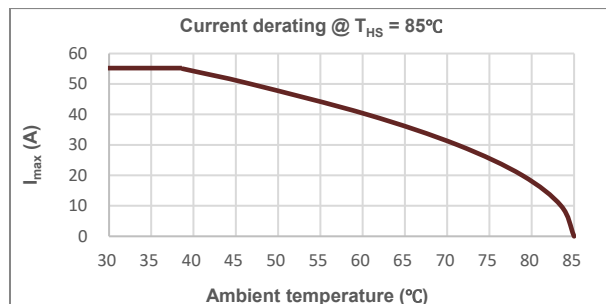

B25690F1467K101

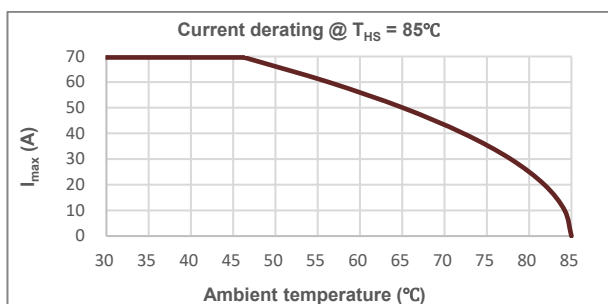

B25690F1507K101

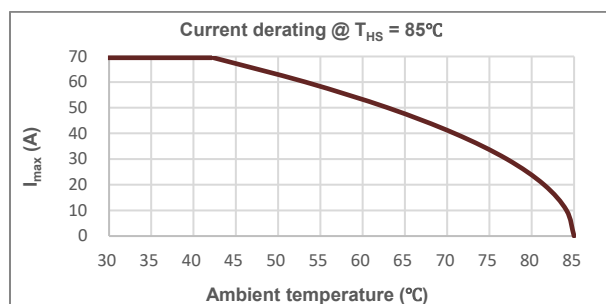

B25690F1527K103

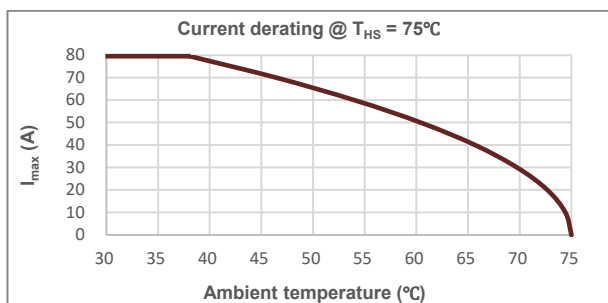

B25690F1717K103

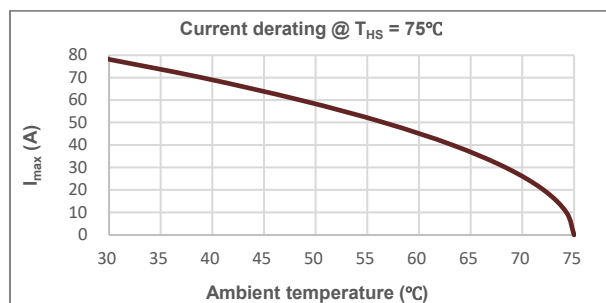

B25690F1977K103

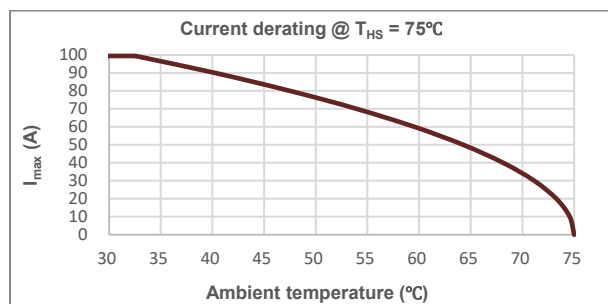

B25690F1138K103

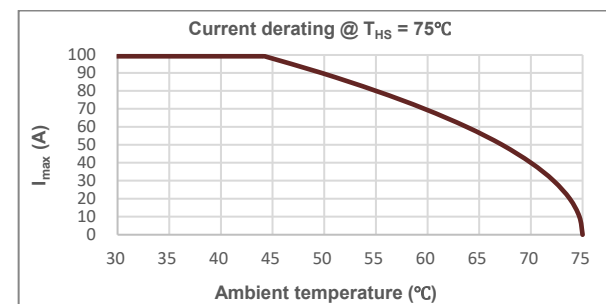

2.4 Current derating curves for capacitors $V_{R, DC} = 1200$ VDC

B25690F1207K201

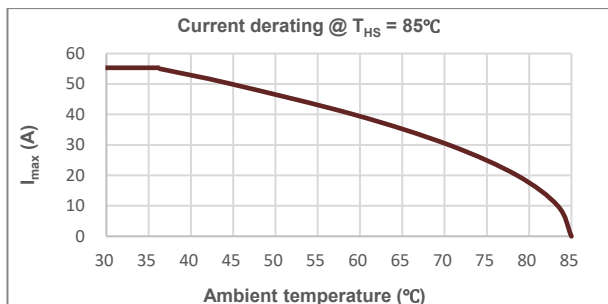

B25690F1297K201

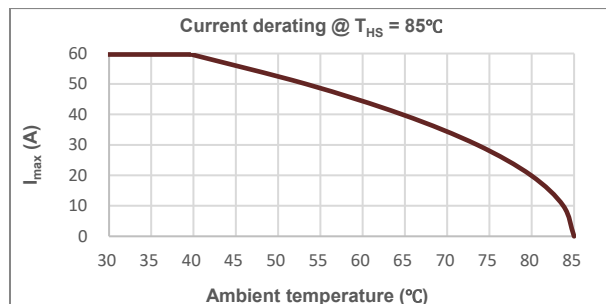

B25690F1307K201

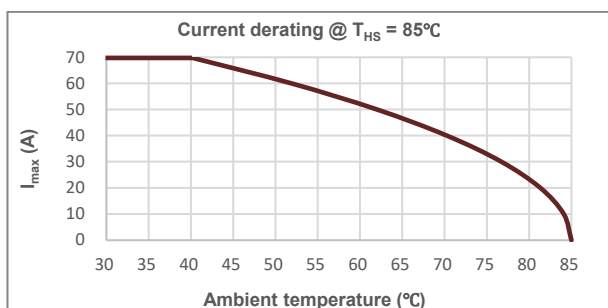

B25690F1587K203

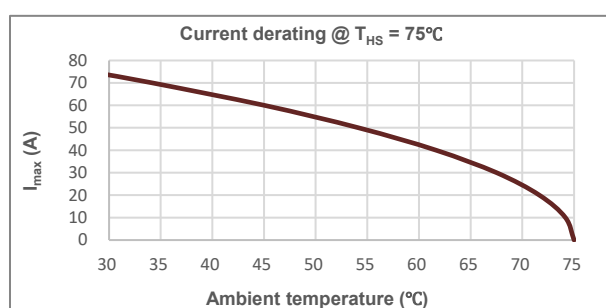

B25690F1677K203

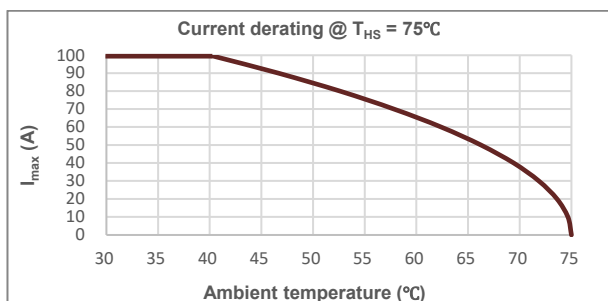

B25690F1717K203

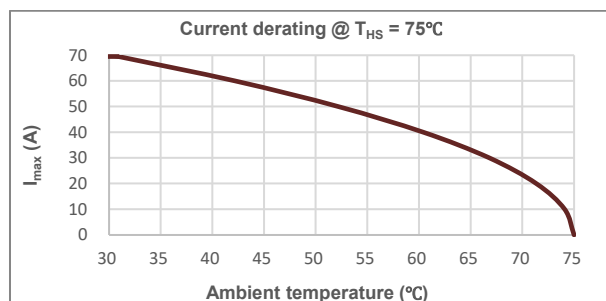

B25690F1797K203

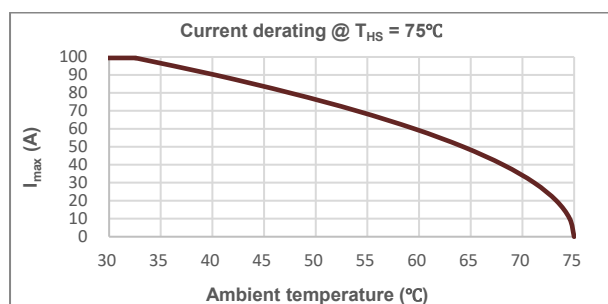

B25690F1118K203

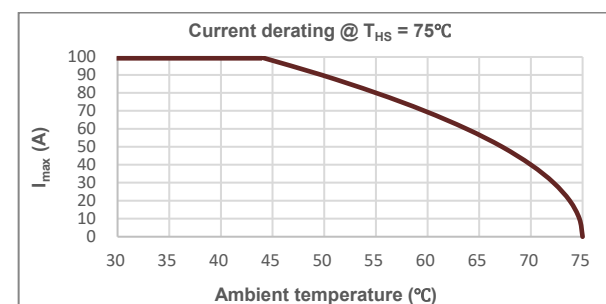

3. Lifetime expectancy

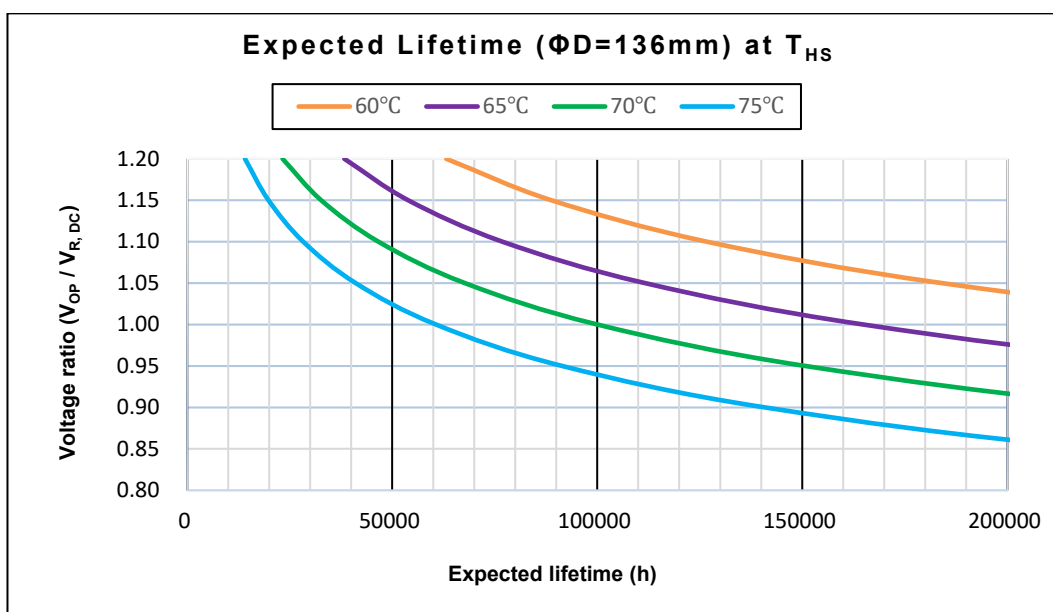
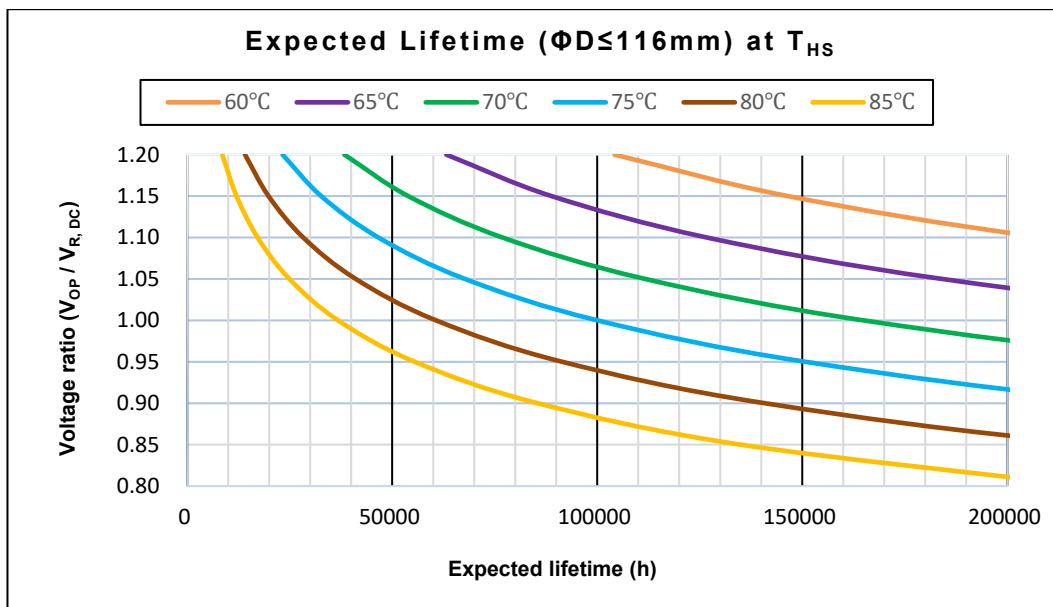

Lifetime expectancy (t_{LD}) in hours at different hot spot temperature (T_{HS}) and voltage $V_{R,DC}$

For capacitors with diameter 116 mm a maximum hot spot temperature of 85°C or capacitors with diameter 136 mm a maximum hot spot temperature of 80°C is allowed during short term operation (maximum 10% of the total load duration) without further reduction of the lifetime expectancy.

Failure criteria is capacitance drop higher than 3%.

Lifetime estimations are typical theoretical values derived from lifetime tests based on TDK internal standards or mutually agreed test methods and are intended for guidance purposes only. The useful life does not constitute a warranty of any kind or a prolongation of the agreed warranty period.

4. Expected failure rate

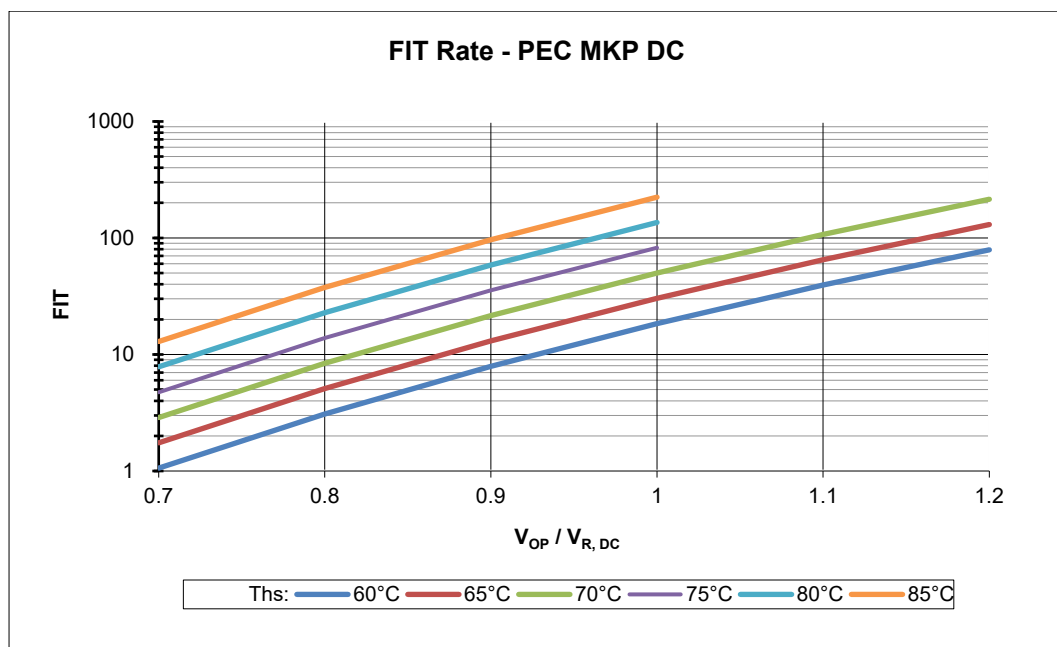

Expected fit rate ($\alpha_{FQ (co)}$) at different hot spot temperatures (T_{HS}) and voltage V_{R, DC}

The FIT (Failure In Time) of a component is defined as the number of expected failures in 10⁹ hours of operation.

The FIT rate is calculated based on the number of components operating in the field and the estimated hours of operation. All the reports of failures are taken into consideration for this calculation, which is updated every year.

The other values in the graph are given as indication and calculated based on acceleration factors.

Terms and characteristics

The following definitions apply to power capacitors according to IEC 61071.

Rated capacitance C_R

Nominal value of the capacitance at 20 °C and measuring frequency of 100 Hz.

Rated DC voltage $V_{R, DC}$

Maximum operating peak voltage of either polarity but of a non-reversing type wave form, for which the capacitor has been designed, for continuous operation.

Operating voltage V_{OP}

The operating voltage of the capacitor.

Ripple voltage V_{ripple}

Peak-to-peak alternating component of the unidirectional voltage.

Maximum surge voltage V_s

Peak voltage induced by a switching or any other disturbance of the system which is allowed for a limited number of times and short period.

Insulation voltage V_i

RMS rated value of the insulation voltage of capacitive elements and terminals to case or earth. When it is not specified in the product data sheet, the insulation voltage is at least:

$$V_i = \frac{V_{RDC}}{\sqrt{2}}$$

AC voltage test between terminals and case V_{TC}

Units having all terminals insulated from the container shall be subjected for 10 s to a voltage applied between the terminals (joined together) and the container.

Maximum rate of voltage rise $(dV/dt)_{max}$

Maximum permissible repetitive rate of voltage rise of the operational voltage.

Maximum current I_{max}

Maximum RMS current for continuous operation for the given frequency range and for the maximum ripple voltage. Please provide Frequency Spectrum of RMS current to your sales contact.

Maximum peak current \hat{I}

Maximum permissible repetitive current amplitude during continuous operation.

Maximum peak current (\hat{I}) and maximum rate of voltage rise $(dV/dt)_{max}$ on a capacitor are related as follows:

$$\hat{I} = C \cdot (dV/dt)_{max}$$

Maximum surge current \hat{I}_s

Admissible peak current induced by a switching or any other disturbance of the system which is allowed for a limited number of times and short period.

$$\hat{I}_s = C \cdot (dV/dt)_s$$

Ambient temperature T_A

Temperature of the surrounding air, measured at 10 cm distance and 2/3 of the case height of the capacitor.

Lowest operating temperature $T_{op,min}$

Lowest permitted ambient temperature at which a capacitor may be energized.

Maximum operating temperature $T_{op,max}$

Highest permitted capacitor temperature during operation, i.e. temperature at the hottest point of the case.

Hot-spot temperature T_{HS}

Temperature zone inside of the capacitor at hottest spot.

$$T_{HS} = T_A + I_{RMS}^2 \cdot ESR \cdot R_{th}$$

Tangent of the loss angle of a capacitor $\tan \delta$

Ratio between the equivalent series resistance and the capacitive reactance of a capacitor at a specified sinusoidal alternating voltage, frequency and temperature.

Series resistance R_s

The sum of all Ohmic resistances occurring inside the capacitor.

ESR

Effective resistance which, if connected in series with an ideal capacitor of capacitance value equal to that of the capacitor in question, would have a power loss equal to active power dissipated in that capacitor under specified operating conditions.

$$ESR = \frac{\tan \delta}{\omega \cdot C} = R_s + \frac{\tan \delta_0}{\omega \cdot C}$$

Thermal resistance R_{th}

The thermal resistance indicates by how many degrees the capacitor temperature at the hot spot rises in relation to the dissipation losses.

Maximum power loss P_{max}

Maximum permissible power dissipation for the capacitor's operation.

$$P_{max} = \frac{T_{hs} - T_A}{R_{th}}$$

Self inductance L_{self}

The sum of all inductive elements which are contained in a capacitor.

Resonance frequency f_r

The lowest frequency at which the impedance of the capacitor becomes minimum.

$$f_r = \frac{1}{2\pi \cdot \sqrt{L_{self} \cdot C_R}}$$

Cautions and Warnings

General

- In case of dents of more than 1 mm depth or any other mechanical damage, capacitors must not be used at all.
- Check tightness of the connections/terminals periodically.
- The energy stored in capacitors may be lethal. To prevent any chance of shock, do not handle the capacitor before it is discharged.
- Failure to follow cautions may result, in premature failures, bursting and fire in the worst case.
- Protect the capacitor properly against over current and short circuit.
- TDK Electronics is not responsible for any kind of possible damages to persons or things due to improper installation and application of capacitors for power electronics.

Safety

Electrical or mechanical misapplication of capacitors may be hazardous. Personal injury or property damage may result if the capacitor should burst or from melted material expulsion due to a capacitor's mechanical disruption.

- Ensure good, effective grounding for capacitor metal enclosures.
- Observe appropriate safety precautions during operation (self-recharging phenomena and the high energy contained in capacitors).
- Handle capacitors carefully because they may still be charged even after disconnection.
- The capacitor's terminals, connected bus bars and cables as well as other devices may also be energized.
- Follow good engineering practice.
- When power capacitors are used, suitable measures must always be taken to eliminate possible danger to humans, animals and property both during operation and when a failure occurs. This applies to capacitors both with and without protective devices. Regular inspection and maintenance by a competent person is therefore essential.

Thermal load

After installation of the capacitor it is necessary to verify that maximum hot-spot temperature is not exceeded at extreme service conditions.

Installation

Capacitors must be installed in a cool and well ventilated place, and not close to objects that radiate heat, or in the direct sunlight. Within high-power inverter systems the capacitors usually produce the smallest portion of the total losses, and the permissible operating temperatures are low compared to power semiconductors, reactors and resistors. So, the distance between capacitor and heating sources must be large enough to avoid the capacitor overheating. In case of space constraint to make the best possible use of capacitors, technically and economically, it is advisable to supply forced cooling air.

Mechanical protection

The capacitor has to be installed in a way that mechanical damages and dents in the aluminum case be avoided.

Connecting

Ensure firm fixing of terminals, fixing torque to be applied as per individual specification.

In any case, the maximum specified terminal current may not be exceeded. Please refer to the technical data of the specific series.

Grounding

The threaded bottom stud of the capacitor has to be used for grounding. In case grounding is done via metal chassis that the capacitor is mounted to, the layer of varnish beneath the washer and nut should be removed. In case, capacitor with plastic case, this is not applicable. Ensure the tightening torque does not exceed the limit.

Maintenance recommendation

Disregarding the following measures may result in severe operation failures, bursting and fire:

- Check tightness of the connections/terminals periodically.
- Clean the terminals/bushings periodically to avoid short circuits due dust or other contamination.
- Ensure the current does not exceed the limit.
- In case of a current above the nominal current check your application for modification.
- Check the temperature of energized capacitors. In case of excessive temperature of individual capacitors, it is recommended to replace this capacitor, as this could be an indication for loss factor increase, which is a sign for reaching end of life.

Storage and operating conditions

Do not use or store capacitors in corrosive atmosphere, especially where chloride gas, sulfide gas, acid, alkali, salt or the like are present. In dusty environments regular maintenance and cleaning especially of the terminals is required to avoid conductive path between phases and/or phases and ground.

- Capacitors should not be stored in high temperatures and/or high humidity for long time, we recommend the following storage conditions:
 - temperature between $-40^{\circ}\text{C} \sim 40^{\circ}\text{C}$
 - humidity $\leq 80\%$ RH as average per year
- Storage should not exceed 2 years (from datecode printed on the capacitor). After 1 year of storage time, capacitors must be checked electrically.

Lifetime expectancy

As a rule, TDK Electronics is unfamiliar with individual customer applications or less familiar with them than the customers themselves. The results will not contain the various influences which might occur in respect to TDK products, when TDK products will be incorporated into the customer application. For these reasons, it is ultimately incumbent on the customer to check and decide whether a TDK product with the properties described in the product specification is suitable for use in a particular customer application.

We also point out that in individual cases a malfunction of electronic components or failure before the end of their usual service life cannot be completely ruled out in the current state of the art, even if they are operated as specified. In customer applications requiring a very high level of operational safety and especially in customer applications in which the malfunction or failure of an electronic component could endanger human life or health (e.g. in accident prevention or life-saving systems), it must

therefore be ensured by means of suitable design of the customer application or other action taken by the customer (e.g. installation of protective circuitry or redundancy) that no injury or damage is sustained by third parties in the event of malfunction or failure of an electronic component.

Handling

Do not handle the capacitor before it is discharged! When handling the capacitor, do not take the capacitor from the terminal. This can cause accidents in case the capacitor is charged and additionally the terminal could break.

Important notes

The following applies to all products named in this publication:

1. Some parts of this publication contain **statements about the suitability of our products for certain areas of application**. These statements are based on our knowledge of typical requirements that are often placed on our products in the areas of application concerned. We nevertheless expressly point out **that such statements cannot be regarded as binding statements about the suitability of our products for a particular customer application**. As a rule we are either unfamiliar with individual customer applications or less familiar with them than the customers themselves. For these reasons, it is always ultimately incumbent on the customer to check and decide whether a product with the properties described in the product specification is suitable for use in a particular customer application.
2. We also point out that **in individual cases, a malfunction of electronic components or failure before the end of their usual service life cannot be completely ruled out in the current state of the art, even if they are operated as specified**. In customer applications requiring a very high level of operational safety and especially in customer applications in which the malfunction or failure of an electronic component could endanger human life or health (e.g. in accident prevention or life-saving systems), it must therefore be ensured by means of suitable design of the customer application or other action taken by the customer (e.g. installation of protective circuitry or redundancy) that no injury or damage is sustained by third parties in the event of malfunction or failure of an electronic component.
3. **The warnings, cautions and product-specific notes must be observed.**
4. In order to satisfy certain technical requirements, **some of the products described in this publication may contain substances subject to restrictions in certain jurisdictions (e.g. because they are classed as hazardous)**. Useful information on this will be found in our Material Data Sheets on the Internet (www.tdk-electronics.tdk.com/material). Should you have any more detailed questions, please contact our sales offices.
5. We constantly strive to improve our products. Consequently, **the products described in this publication may change from time to time**. The same is true of the corresponding product specifications. Please check therefore to what extent product descriptions and specifications contained in this publication are still applicable before or when you place an order.

We also **reserve the right to discontinue production and delivery of products**. Consequently, we cannot guarantee that all products named in this publication will always be available. The aforementioned does not apply in the case of individual agreements deviating from the foregoing for customer-specific products.

6. Unless otherwise agreed in individual contracts, **all orders are subject to our General Terms and Conditions of Supply**.
7. **Our manufacturing sites serving the automotive business apply the IATF 16949 standard**. The IATF certifications confirm our compliance with requirements regarding the quality management system in the automotive industry. Referring to customer requirements and customer specific requirements ("CSR") TDK always has and will continue to have the policy of respecting individual agreements. Even if IATF 16949 may appear to support the acceptance of unilateral requirements, we hereby like to emphasize that **only requirements mutually agreed upon can and will be implemented in our Quality Management System**. For clarification purposes we like to point out that obligations from IATF 16949 shall only become legally binding if individually agreed upon.

Important notes

8. The trade names EPCOS, CarXield, CeraCharge, CeraDiode, CeraLink, CeraPad, CeraPlas, CSMP, CTVS, DeltaCap, DigiSiMic, FilterCap, FormFit, InsuGate, LeaXield, MediPlas, MiniBlue, MiniCell, MKD, MKK, ModCap, MotorCap, PCC, PhaseCap, PhaseCube, PhaseMod, PhiCap, PiezoBrush, PlasmaBrush, PowerHap, PQSine, PQvar, SIFERRIT, SIFI, SIKOREL, SilverCap, SIMDAD, SiMic, SIMID, SineFormer, SIOV, SurfIND, ThermoFuse, WindCap, XieldCap are **trademarks registered or pending** in Europe and in other countries. Further information will be found on the Internet at www.tdk-electronics.tdk.com/trademarks.

Release 2024-02