

Ultra-Compact 2.4 GHz Ceramic Chip Antenna

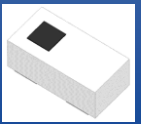

AANI-CH-0070

Request Samples



Check Inventory



1.0 x 0.5 x 0.4 mm
RoHS/RoHS II Compliant
MSL Level = 1

Features

- Miniature form factor: 1.0 x 0.5 x 0.4 mm
- Compact & Low-Profile
- Low return loss of: ≤ -6.5 dB
- Peak Gain: 1.7 dBi
- Efficiency: ≥ -3.2 dB (48%)
- Surface Mount (SMD)
- Integration: Along PCB Edge

Applications

- WiFi 2.4GHz
- Bluetooth / BLE
- ZigBee
- ISM
- IoT, M2M
- Wearables
- Wireless Remote Control
- Industrial/Commercial equipment

Product Image

The chip antenna from top and bottom view:

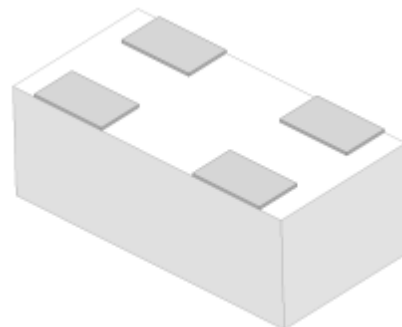
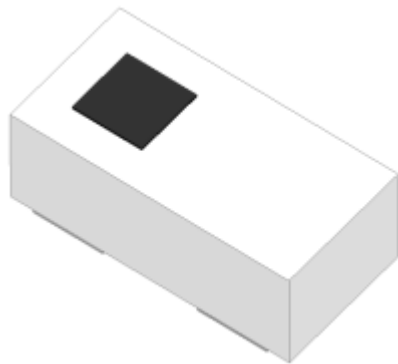

Ultra-Compact 2.4 GHz Ceramic Chip Antenna

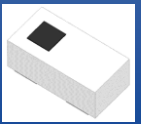

AANI-CH-0070

Request Samples



Check Inventory



1.0 x 0.5 x 0.4 mm
RoHS/RoHS II Compliant
MSL Level = 1

Electrical Specification

Parameter	Specification	Unit
Operating Frequency	2400 - 2500	MHz
Return Loss	≤ -6.5	dB
Polarization	Linear	-
Peak Gain	1.7	dBi
Efficiency	≥ -3.2 (48)	dB (%)
Impedance	50	Ω
Radiation Pattern	Omni-directional	-
Input Power	≤ 2.0	W

Note: All measurements were conducted on the evaluation board in free space. Performance will vary depending on the ground plane, application, and environment.

Mechanical Specification

Parameter	Specification
Antenna Dimension	1.0 x 0.5 x 0.4 mm
Footprint Size Imperial (Metric)	0402 (1005M)
Evaluation board Dimension	40 x 22 mm
Recommended Ground Clearance for Antenna	5 x 3 mm
Mounting Type	Surface Mount
Material(s)	Ceramic

Environmental Specification

Parameter	Specification
Operating and Storage Temperature (individual chip without packing)	-40°C to +85°C
Packaging Storage Temperature	-10°C to +40°C
Packaging Storage Relative Humidity	70% (Max.)



5101 Hidden Creek Ln Spicewood TX 78669
Phone: 512-371-6159 | Fax: 512-351-8858
For terms and conditions of sales, please visit:
www.abracon.com

REVISED: 04-04-24

ABRACON IS
ISO9001-2015
CERTIFIED

Ultra-Compact 2.4 GHz Ceramic Chip Antenna



AANI-CH-0070

Request Samples



Check Inventory



1.0 x 0.5 x 0.4 mm
 RoHS/RoHS II Compliant
 MSL Level = 1

Product Dimensions and Terminal Configuration

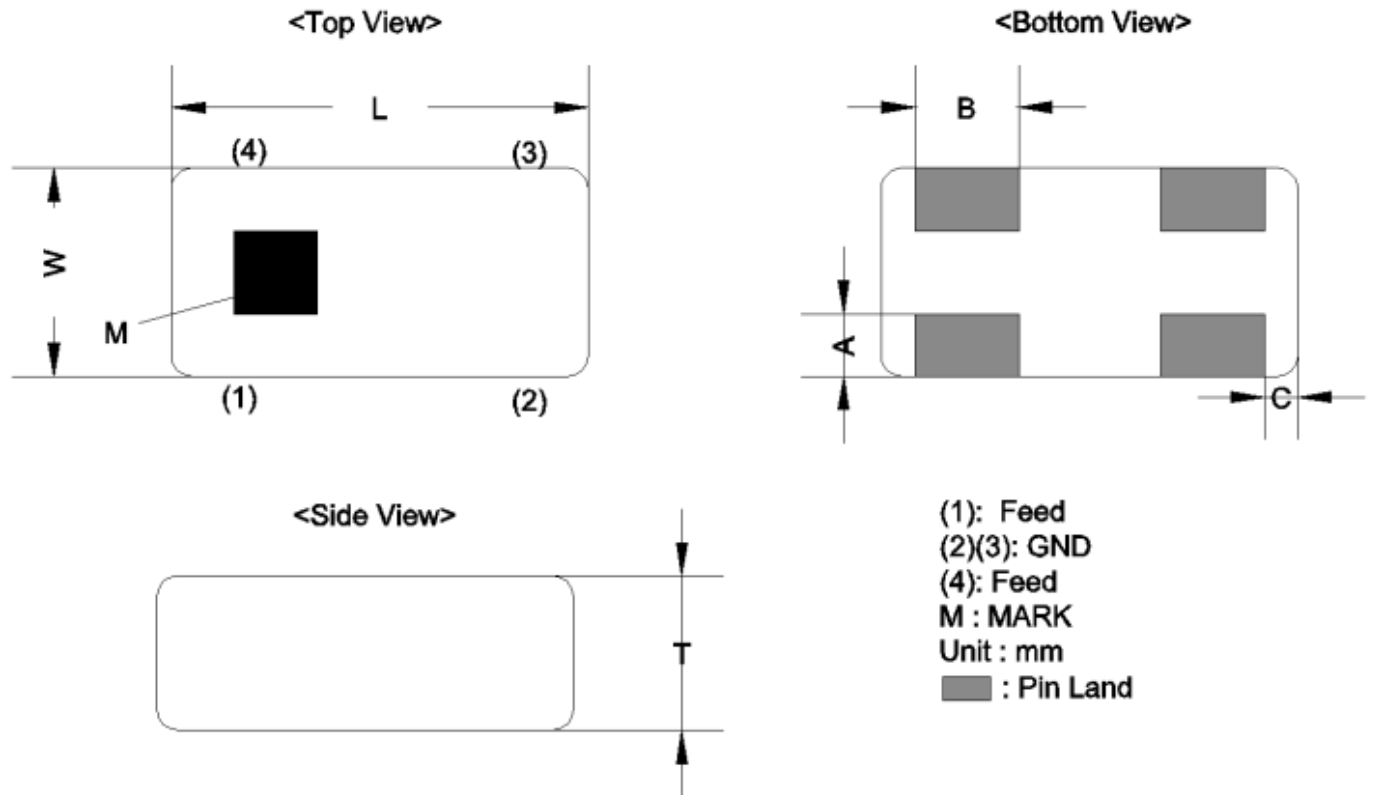

MARK	L	W	T	A	B	C
Dimensions (mm)	1.00 ±0.10	0.50 ±0.10	0.40 ±0.05	0.15 +0.10/-0.05	0.25 +0.10/-0.05	0.08 +0.10/-0.05

Ultra-Compact 2.4 GHz Ceramic Chip Antenna

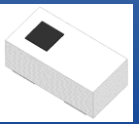

AANI-CH-0070

Request Samples



Check Inventory



1.0 x 0.5 x 0.4 mm
RoHS/RoHS II Compliant
MSL Level = 1

Recommended PCB layout

If there are several layers in the PCB, there is an advantage to add vias for smooth interconnection of the ground areas to avoid splits in the ground plane. It is also important that the ground clearance is respected through all layers of the PCB. It is recommended to implement a matching network to optimize the antenna impedance in your application.

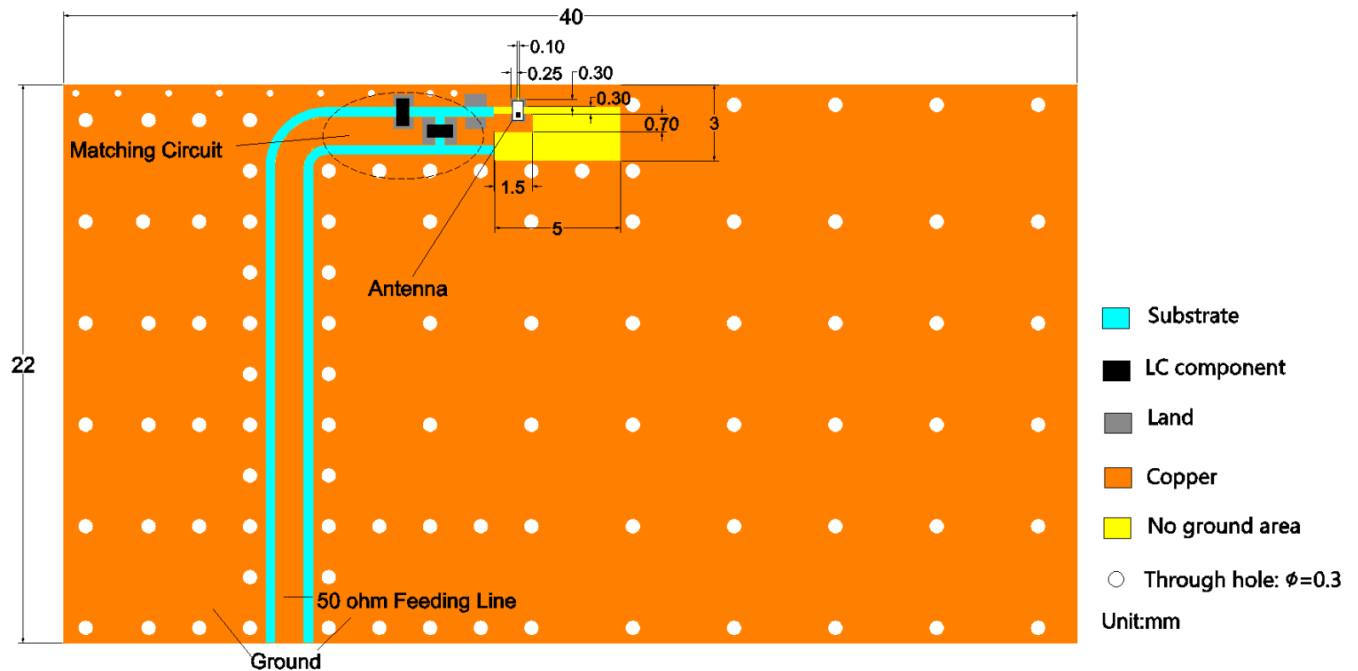

Detailed view of the antenna and ground clearance area:

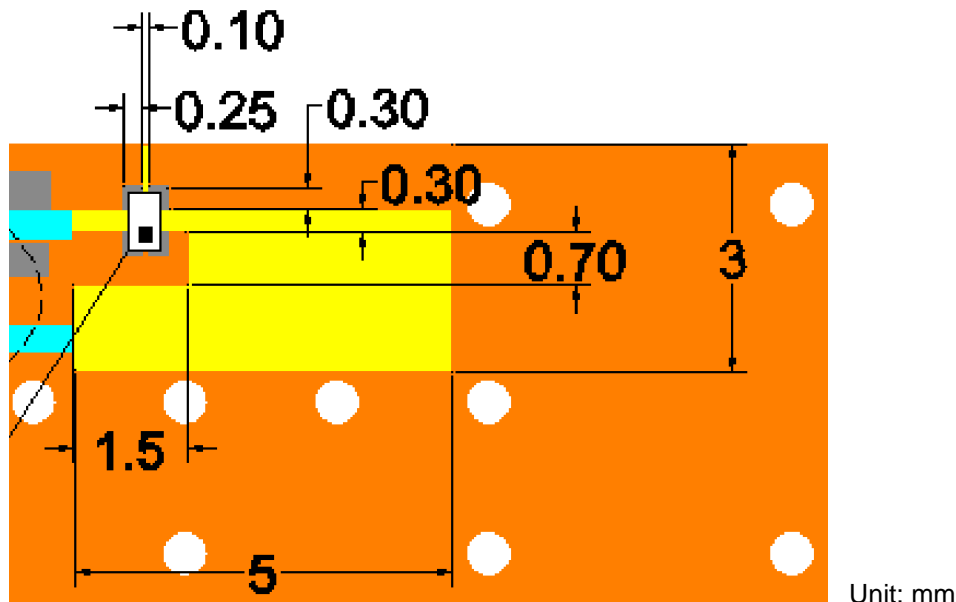

Ultra-Compact 2.4 GHz Ceramic Chip Antenna

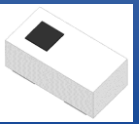

AANI-CH-0070

Request Samples



Check Inventory



1.0 x 0.5 x 0.4 mm
RoHS/RoHS II Compliant
MSL Level = 1

Measurement Setup

The antenna measurements were all done in free space, with the chip antenna implemented on its evaluation board that has a PCB size of 40 by 22 mm (excluding the SMA connector):

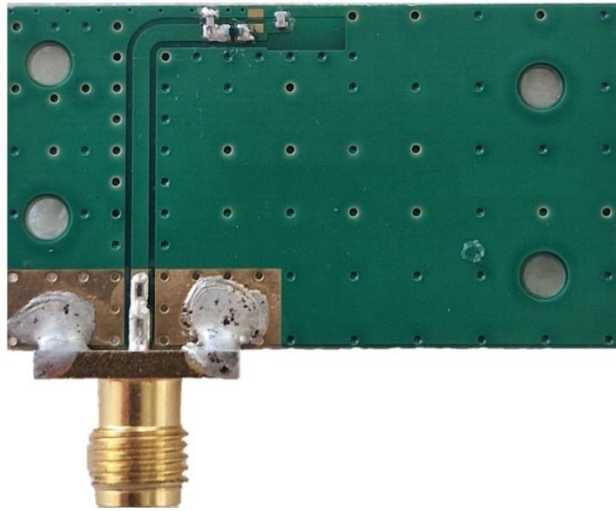

Reflection Characteristics – Return Loss

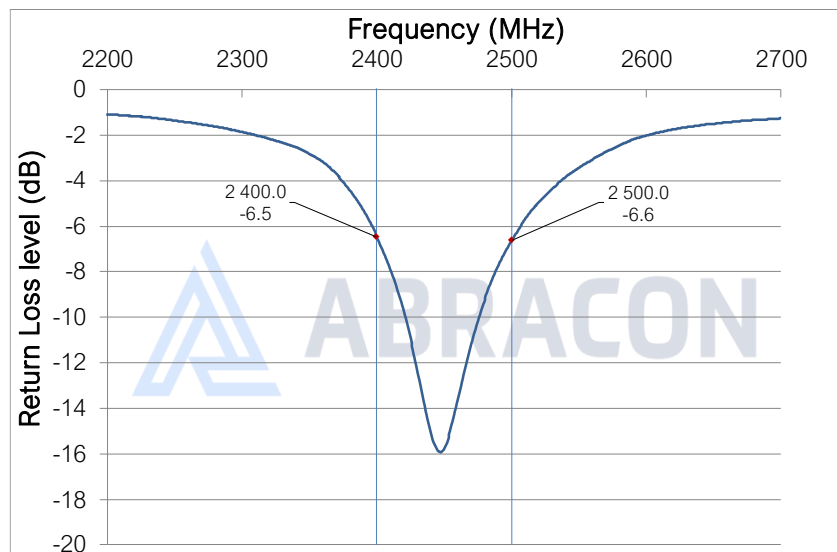

Ultra-Compact 2.4 GHz Ceramic Chip Antenna

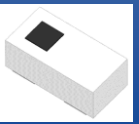

AANI-CH-0070

Request Samples



Check Inventory



1.0 x 0.5 x 0.4 mm
RoHS/RoHS II Compliant
MSL Level = 1

Radiation Characteristics – Total Efficiency (dB)

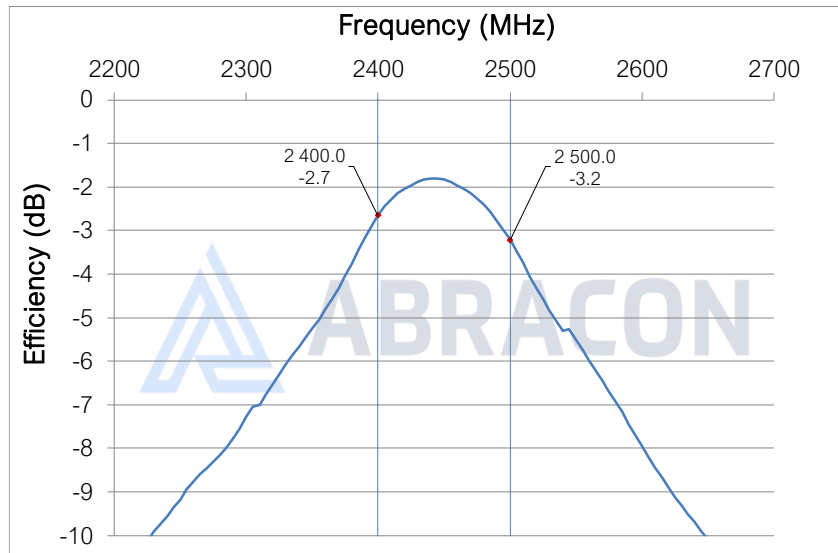

Radiation Characteristics – Total Efficiency (%)

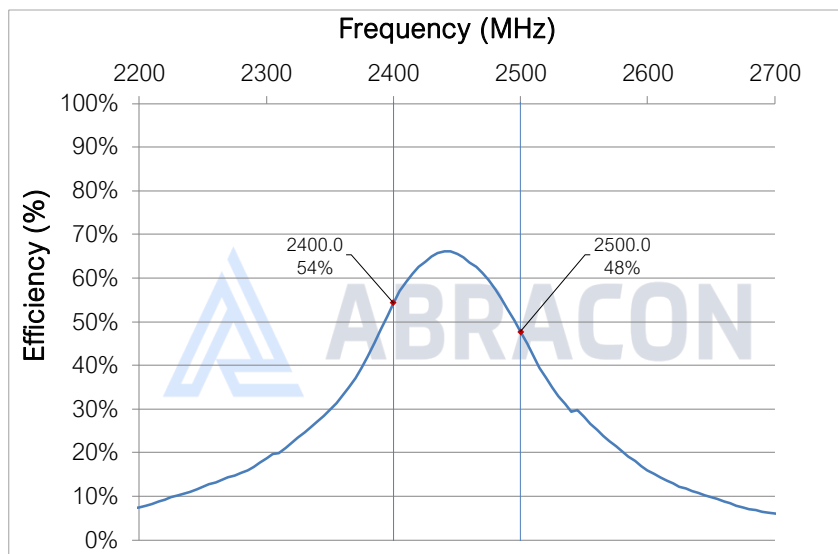

5101 Hidden Creek Ln Spicewood TX 78669
Phone: 512-371-6159 | Fax: 512-351-8858
For terms and conditions of sales, please visit:
www.abracon.com

REVISED: 04-04-24

ABRACON IS
ISO9001-2015
CERTIFIED

Ultra-Compact 2.4 GHz Ceramic Chip Antenna

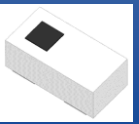

AANI-CH-0070

Request Samples



Check Inventory



1.0 x 0.5 x 0.4 mm
RoHS/RoHS II Compliant
MSL Level = 1

Radiation Characteristics – Maximum Gain

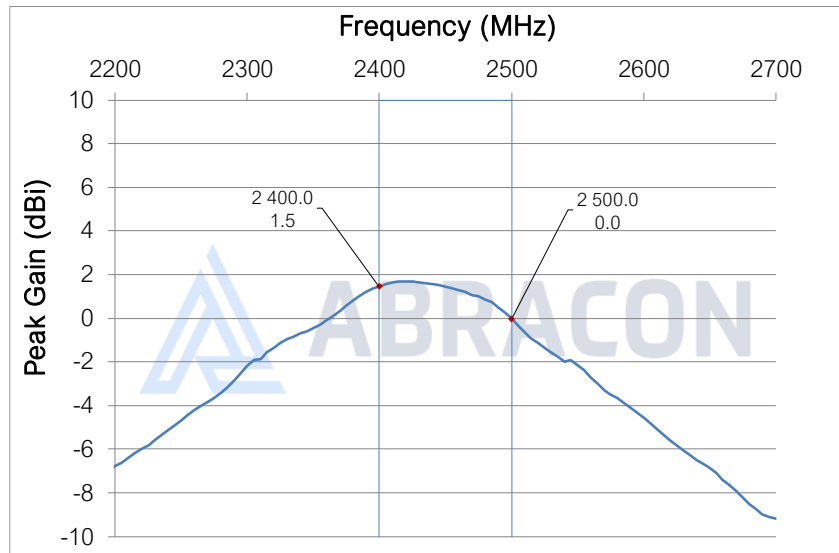

Radiation Characteristics – 3D Pattern @ 2450 MHz

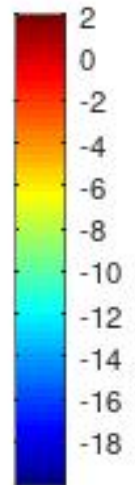
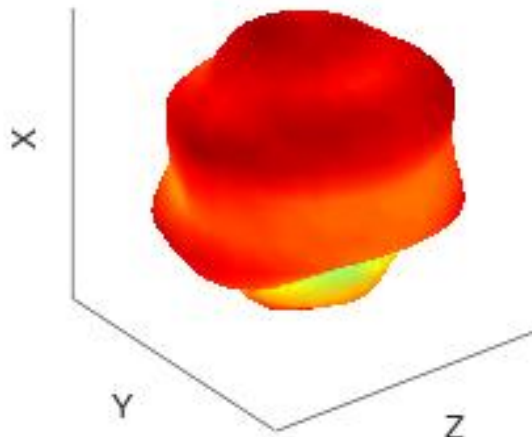

Unit: dBi

Ultra-Compact 2.4 GHz Ceramic Chip Antenna

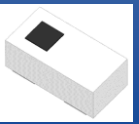

AANI-CH-0070

Request Samples



Check Inventory



1.0 x 0.5 x 0.4 mm
RoHS/RoHS II Compliant
MSL Level = 1

Radiation Characteristics – 2D Pattern @ 2450 MHz

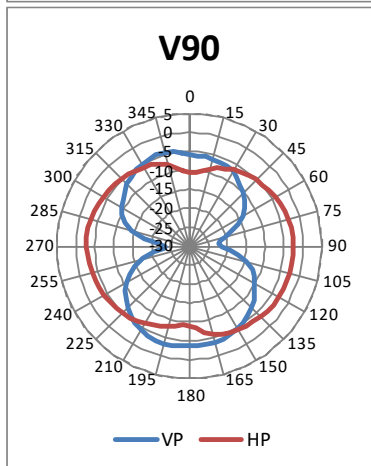
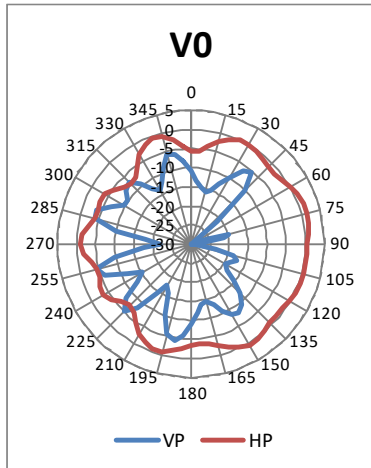
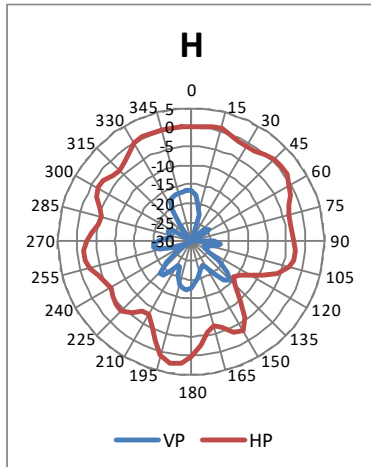

VP: Vertical Polarization
HP: Horizontal Polarization

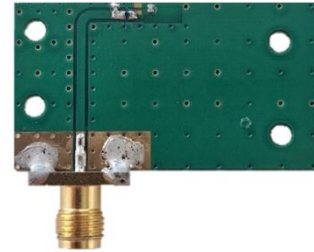

Unit: dBi



5101 Hidden Creek Ln Spicewood TX 78669
Phone: 512-371-6159 | Fax: 512-351-8858
For terms and conditions of sales, please visit:
www.abracon.com

REVISED: 04-04-24

ABRACON IS
ISO9001-2015
CERTIFIED

Ultra-Compact 2.4 GHz Ceramic Chip Antenna

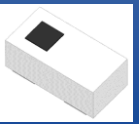

AANI-CH-0070

Request Samples



Check Inventory



1.0 x 0.5 x 0.4 mm
RoHS/RoHS II Compliant
MSL Level = 1

Evaluation Board Outline & Matching Circuit

The evaluation board is developed to simplify antenna testing and evaluation. It has an arbitrary ground plane size of 40 x 22 mm and includes an SMA connector. The purpose is to give a reference design for an optimal antenna implementation. The evaluation board can also be used to test other implementations by cutting and soldering the PCB into any device.

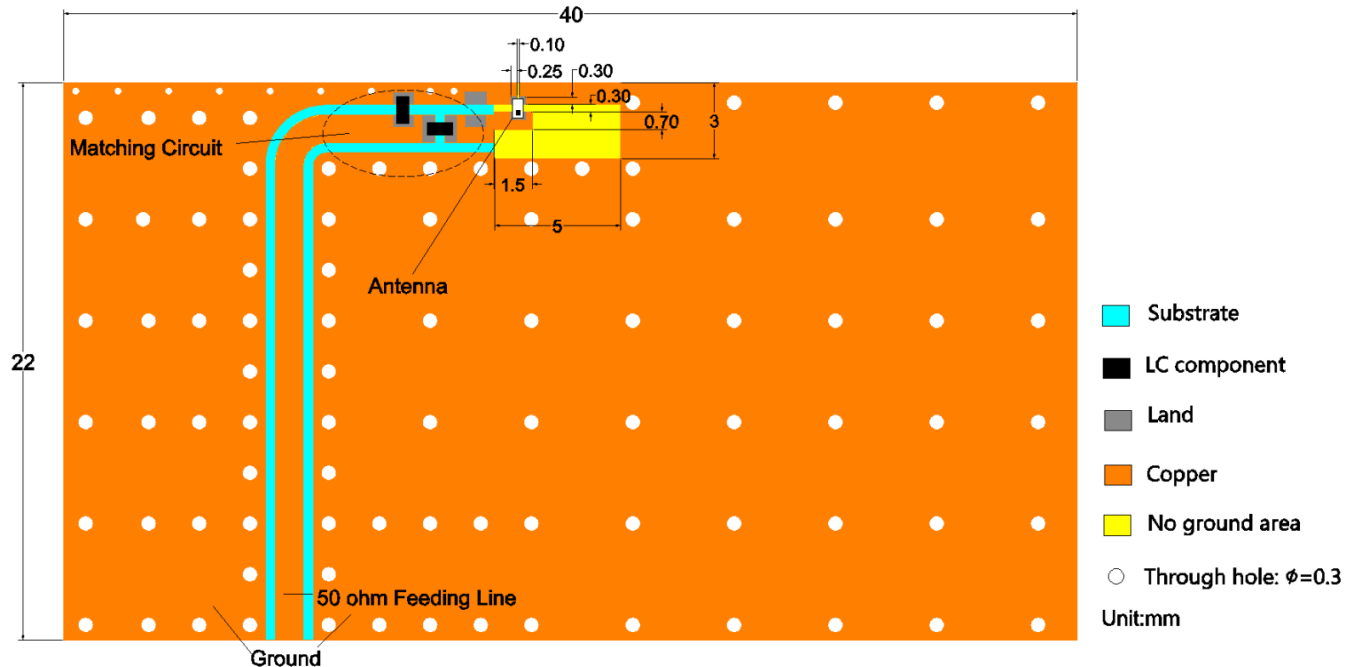

The evaluation board has a matching circuit implemented next to the antenna. This is aimed to enable optimization possibilities for the user. The component positions are sized for 0402 (1005 metric) SMD components.

The antenna needs a matching circuit to adjust the resonant frequency balance. When delivered, the evaluation board is tuned for optimum balance at 2.4 – 2.5 GHz using the following (can be replaced by equivalent):

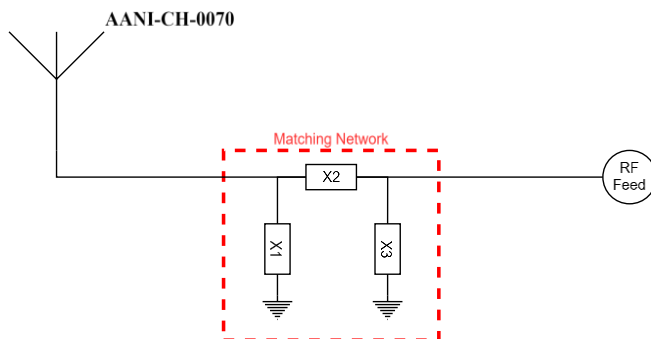

X1 = not mounted
X2 = 3.8 nH (Murata LQW15AN3N8C10D)
X3 = 1.2 pF (Murata GJM1555C1H1R2WB01D)

However, it is common that the resonant frequency will shift during implementation in an arbitrary device. Therefore, this matching may be changed with other values/components/brands for compensation of such effects.

Ultra-Compact 2.4 GHz Ceramic Chip Antenna



AANI-CH-0070

Request Samples



Check Inventory



1.0 x 0.5 x 0.4 mm
RoHS/RoHS II Compliant
MSL Level = 1

Reflow Profile

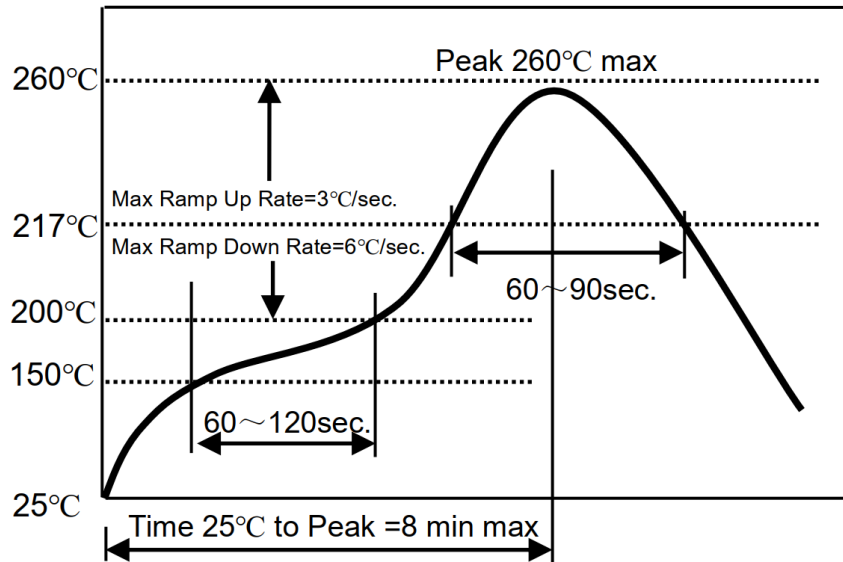

- Solder paste: Sn/3.0Ag/0.5C
- Reflow Cycles: 2 max.

Note: The reflow profile is only for qualification and is not meant to specify board assembly profiles. Actual board assembly profiles must be based on the customer's specific board design, solder paste and process, and should not exceed the parameters as the Reflow profile shows.

Iron Soldering Profile

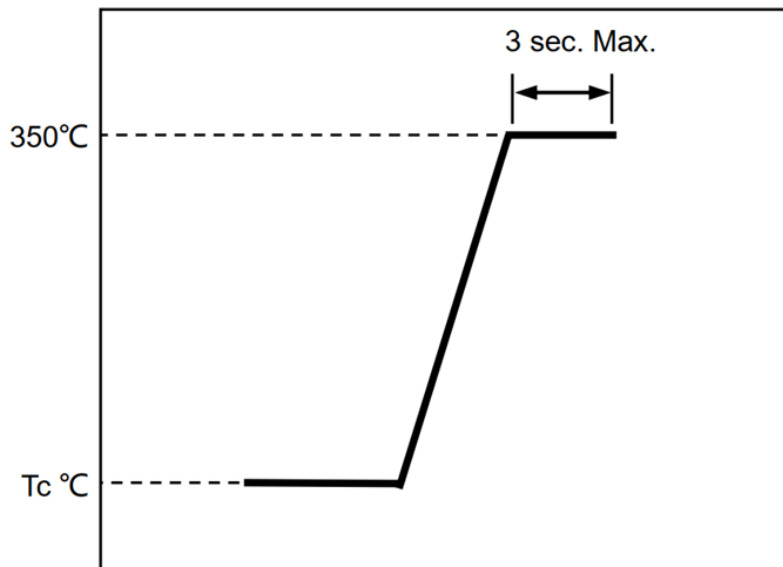

- Solder paste: Sn/3.0Ag/0.5C
- Max. 1 times for iron soldering
- Pre-heating (Tc): 150 °C / 60 sec
- Maximum iron soldering power: 30W
- Diameter of soldering iron tip: 1.0 mm max.

Note: Take care not to apply the tip of the soldering iron to the terminal electrodes.

Ultra-Compact 2.4 GHz Ceramic Chip Antenna

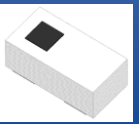

AANI-CH-0070

Request Samples



Check Inventory



1.0 x 0.5 x 0.4 mm
RoHS/RoHS II Compliant
MSL Level = 1

Packaging

Tape & Reel dimensions (10K pcs per reel):

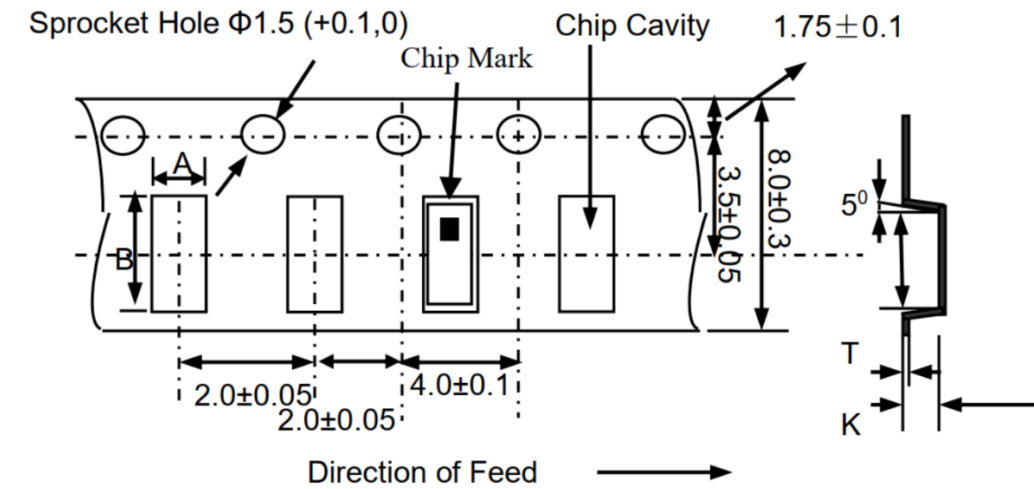

Chip Thickness	0.40 ± 0.05
A	0.62 ± 0.05
B	1.12 ± 0.05
K max	0.60
T max	0.35

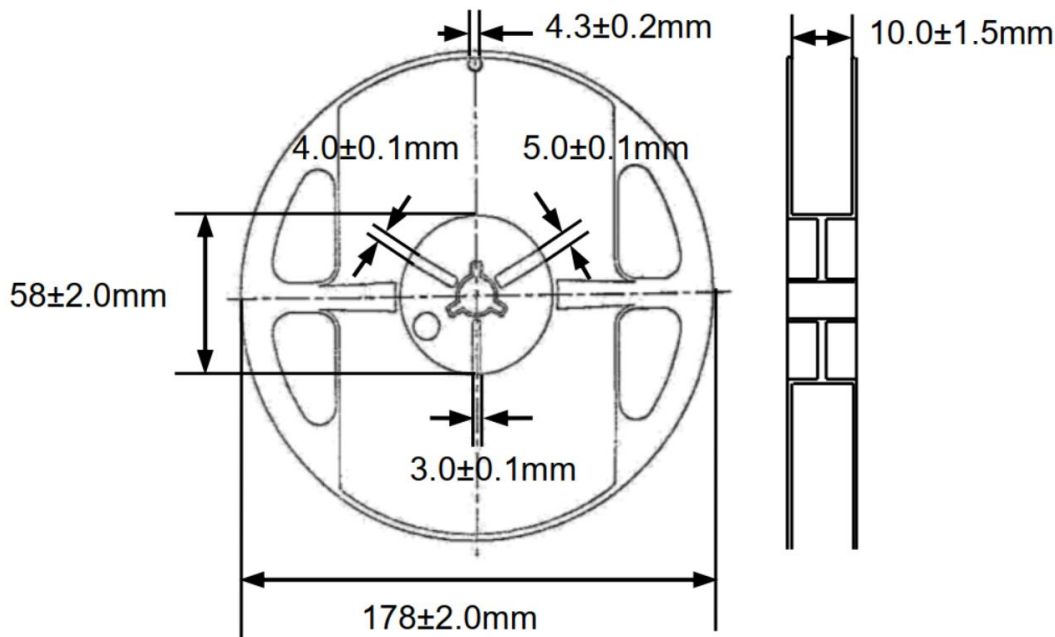

ATTENTION: Abracon LLC's products are Commercial-Off-The-Shelf (COTS), which are designed, intended, and validated for use in commercial, industrial, and automotive applications. The customer is responsible for testing and verifying the performance of an Abracon solution to meet their system-level requirements.



5101 Hidden Creek Ln Spicewood TX 78669
Phone: 512-371-6159 | Fax: 512-351-8858
For terms and conditions of sales, please visit:
www.abracon.com

REVISED: 04-04-24

ABRACON IS
ISO9001-2015
CERTIFIED