



# TBS-1QES23506CE

TBS

RESISTANCE THERMOMETER

**SICK**  
Sensor Intelligence.



Illustration may differ



## Ordering information

Type	Part no.
TBS-1QES23506CE	6065328

Other models and accessories → [www.sick.com/TBS](http://www.sick.com/TBS)

## Detailed technical data

### Features

<b>Temperature measuring range</b>	-20 °C ... +120 °C
<b>Sensor element</b>	Pt1000, 2-wire, class A according to IEC 60751
<b>Output signals</b>	IO-Link/PNP + PNP + 4 mA ... 20 mA
<b>Switching output</b>	Transistor
<b>Switching voltage</b>	Supply voltage [V DC] - 1 V DC
<b>Maximum switching current</b>	≤ 250 mA
<b>Switching delay</b>	0 s ... 50 s, programmable
<b>Setting accuracy of switching outputs</b>	+0.1 °C
<b>Switching output</b>	Transistor
Number	3
Switching voltage	Supply voltage [V DC] - 1 V DC
Maximum switching current	≤ 250 mA
Switching delay	0 s ... 50 s, programmable
Setting accuracy of switching outputs	+0.1 °C
<b>Scaling of measuring range</b>	Zero point: max. +25 % of span Full scale: max. -25 % of span
<b>Scaling of measuring range</b>	Max. +25 % of span, max. -25 % of span
<b>Display</b>	14-segment LED, blue, 4-digits, height 9 mm, Display electronically turnable by 180 °, update: 200 ms
<b>Rotatable housing</b>	Display against housing with electrical connection: 330 ° Housing against process connection: 320 °

### Mechanics/electronics

<b>Process connection</b>	Compression fitting G ½ A according to DIN 3852-A
<b>Insertion length/diameter of probe</b>	350 mm / 6 mm

<sup>1)</sup> At room temperature and when connected through thread.

<sup>2)</sup> IP enclosure rating as per IEC 60529.

<b>Seal</b>	Copper
<b>Wetted parts</b>	Stainless steel 1.4571 (AISI 316Ti)
<b>Maximum process pressure</b>	≤ 150 bar <sup>1)</sup>
<b>Housing material</b>	Lower body: stainless steel 1.4301 (AISI 304) Plastic head: PC + ABS Input keypad: TPE-E Display window: PC
<b>Connection type</b>	Round connector M12 x 1, 5-pin
<b>Enclosure rating</b>	IP65 <sup>2)</sup> IP67 <sup>2)</sup>
<b>Maximum ohmic load R<sub>A</sub></b>	≤ 100 kΩ (Switching outputs) < 0.5 kΩ (output signal 4 mA ... 20 mA)
<b>Supply voltage</b>	15 V DC ... 35 V DC
<b>Maximum current consumption</b>	45 mA
<b>Total current consumption</b>	570 mA (incl. switching current) 320 mA
<b>Protection class</b>	III
<b>Isolation voltage</b>	500 V DC
<b>Overvoltage protection</b>	40 V DC
<b>Short-circuit protection</b>	Outputs Q <sub>A</sub> , Q <sub>1</sub> , Q <sub>2</sub> towards M
<b>Reverse polarity protection</b>	L <sup>+</sup> towards M
<b>Electrical safety</b>	
Protection class	III
Isolation voltage	500 V DC
Overvoltage protection	40 V DC
Short-circuit protection	Outputs Q <sub>A</sub> , Q <sub>1</sub> , Q <sub>2</sub> towards M
Reverse polarity protection	L <sup>+</sup> towards M
<b>CE-conformity</b>	2004/108/EC, EN 61326-1 emission (group 1, class B) and interference immunity (industrial application)
<b>RoHS certificate</b>	✓
<b>MTTF</b>	283 years

<sup>1)</sup> At room temperature and when connected through thread.

<sup>2)</sup> IP enclosure rating as per IEC 60529.

## Performance

<b>Accuracy of sensor element</b>	≤ ± (0.15 °C + 0.002  t ) <sup>1)</sup>
<b>Accuracy of switching output</b>	≤ ± 0.8 % of span
<b>Display accuracy</b>	≤ ± 0.8 % of span ± 1 digit
<b>Accuracy of analog output</b>	≤ ± 0.5 % of span
<b>Response time t<sub>50</sub></b>	≤ 5 s <sup>2)</sup>
<b>Response time t<sub>90</sub></b>	≤ 10 s <sup>2)</sup>

<sup>1)</sup> |t| is the absolute value of the temperature in °C.

<sup>2)</sup> Depending on sensor configuration, according to IEC 60751.

## Ambient data

<b>Ambient temperature</b>	-20 °C ... +80 °C
<b>Storage and transport temperature</b>	-20 °C ... +80 °C
<b>Relative humidity</b>	45 % ... 75 %

## Classifications

<b>eCl@ss 5.0</b>	27200208
<b>eCl@ss 5.1.4</b>	27200208
<b>eCl@ss 6.0</b>	27200208
<b>eCl@ss 6.2</b>	27200208
<b>eCl@ss 7.0</b>	27200208
<b>eCl@ss 8.0</b>	27200208
<b>eCl@ss 8.1</b>	27200208
<b>eCl@ss 9.0</b>	27200208
<b>eCl@ss 10.0</b>	27200208
<b>eCl@ss 11.0</b>	27200208
<b>eCl@ss 12.0</b>	27200208
<b>ETIM 5.0</b>	EC002994
<b>ETIM 6.0</b>	EC002994
<b>ETIM 7.0</b>	EC002994
<b>ETIM 8.0</b>	EC002994
<b>UNSPSC 16.0901</b>	41112211

**Dimensional drawing** (Dimensions in mm (inch))

Compression fitting G 1/2 A

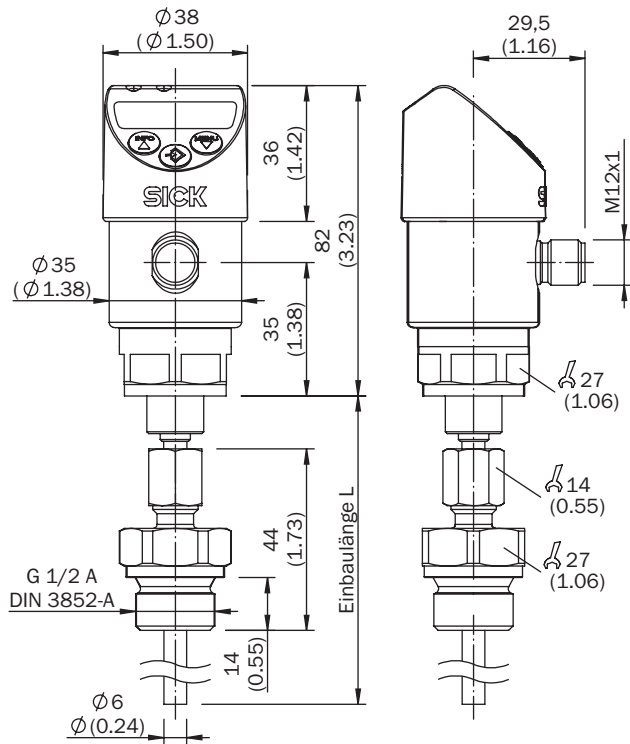

**Connection type**



- ① L+
- ② Q<sub>2</sub>
- ③ M
- ④ Q<sub>1</sub>
- ⑤ Q<sub>A</sub>

## SICK AT A GLANCE

SICK is one of the leading manufacturers of intelligent sensors and sensor solutions for industrial applications. A unique range of products and services creates the perfect basis for controlling processes securely and efficiently, protecting individuals from accidents and preventing damage to the environment.

We have extensive experience in a wide range of industries and understand their processes and requirements. With intelligent sensors, we can deliver exactly what our customers need. In application centers in Europe, Asia and North America, system solutions are tested and optimized in accordance with customer specifications. All this makes us a reliable supplier and development partner.

Comprehensive services complete our offering: SICK LifeTime Services provide support throughout the machine life cycle and ensure safety and productivity.

For us, that is “Sensor Intelligence.”

## WORLDWIDE PRESENCE:

Contacts and other locations –[www.sick.com](http://www.sick.com)