



# OD1-B100H50A15

OD Mini

DISPLACEMENT MEASUREMENT SENSORS

**SICK**  
Sensor Intelligence.



### Ordering information

Type	Part no.
OD1-B100H50A15	6054084

Other models and accessories → [www.sick.com/OD\\_Mini](http://www.sick.com/OD_Mini)



### Detailed technical data

#### Mechanics/electronics

<b>Supply voltage <math>V_s</math></b>	DC 12 V (-5 %) ... DC 24 V (+10 %)
<b>Power consumption</b>	$\leq 1.92 \text{ W}^{1)}$
<b>Warm-up time</b>	$\leq 5 \text{ min}$
<b>Housing material</b>	Stainless steel
<b>Window material</b>	Plastic (PPSU)
<b>Connection type</b>	Cable with male connector, M12, 5-pin, 30 cm
<b>Indication</b>	4-digit 7-segment display (plus 4 LEDs for status display)
<b>Control elements</b>	4 buttons
<b>Weight</b>	70 g
<b>Dimensions (W x H x D)</b>	17.8 mm x 44.4 mm x 31 mm
<b>Enclosure rating</b>	IP67
<b>Protection class</b>	III

<sup>1)</sup> Without load, with current output.

#### Safety-related parameters

<b>MTTF<sub>D</sub></b>	101 years
<b>DC<sub>avg</sub></b>	0%

#### Performance

<b>Measurement range min ... max:</b>	50 mm ... 150 mm
<b>Target</b>	Natural objects

<sup>1)</sup> Averaging function set to: 512.

<sup>2)</sup> Constant ambient conditions.

<sup>3)</sup> Measurement on 90 % remission (ceramic, white).

<sup>4)</sup> With fixed sensitivity adjustment and averaging setting = 1. With automatic sensitivity and measuring rate 500  $\mu\text{s}$ : 2 ... 7.5 ms response time/measuring rate 1,000  $\mu\text{s}$ : 4 ... 15 ms response time.

<sup>5)</sup> Wavelength: 655 nm, max. output: 390  $\mu\text{W}$  (laser class 1) / < 1 mW (laser class 2).

<b>Repeatability</b>	20 µm <sup>1) 2)</sup>
<b>Linearity</b>	± 100 µm <sup>3)</sup>
<b>Response time</b>	≥ 2 ms <sup>4)</sup>
<b>Measuring frequency</b>	≤ 2 kHz
<b>Output time</b>	≥ 0.5 ms
<b>Light source</b>	Laser, red visible red light
<b>Laser class</b>	1 (IEC 60825-1:2014, EN 60825-1:2014) <sup>5)</sup>
<b>Typ. light spot size (distance)</b>	700 µm x 600 µm (100 mm)
<b>Additional function</b>	Averaging 1 ... 512x, automatic or manual sensitivity adjustment, switching mode: window (Wnd), switching mode: distance to object (DtO), switching mode: object between sensor and background (ObSB), multifunctional input: laser-off / external teach-in / trigger

<sup>1)</sup> Averaging function set to: 512.

<sup>2)</sup> Constant ambient conditions.

<sup>3)</sup> Measurement on 90 % remission (ceramic, white).

<sup>4)</sup> With fixed sensitivity adjustment and averaging setting = 1. With automatic sensitivity and measuring rate 500 µs: 2 ... 7.5 ms response time/measuring rate 1,000 µs: 4 ... 15 ms response time.

<sup>5)</sup> Wavelength: 655 nm, max. output: 390 µW (laser class 1) / < 1 mW (laser class 2).

## Interfaces

<b>Serial</b>	✓, RS-485
<b>PROFIBUS DP</b>	✓
Type of fieldbus integration	Optional, over external evaluation unit AOD1 and Gateway WI180C-PB
<b>Digital output</b>	
Number	1 ... 3 <sup>1)</sup>
Type	PNP/NPN, selectable
<b>Analog output</b>	
Number	1 <sup>1)</sup>
Type	Current output
Current	4 mA ... 20 mA, ≤ 300 Ω

<sup>1)</sup> Optional over evaluation unit AOD1.

## Ambient data

<b>Ambient temperature, operation</b>	-10 °C ... +50 °C
<b>Ambient temperature, storage</b>	-20 °C ... +60 °C
<b>Min. rel. humidity (not condensing)</b>	35 %
<b>Max. rel. humidity (not condensing)</b>	95 %
<b>Temperature drift</b>	± 0.08 % FS/K (FS = Full Scale = Measuring range of sensor)
<b>Typ. Ambient light immunity</b>	Artificial light: ≤ 3,000 lx Sunlight: ≤ 10,000 lx
<b>Vibration resistance</b>	10 Hz ... 55 Hz (amplitude 1.5 mm, x-, y-, z-axis 2 hours each)
<b>Shock resistance</b>	50 G (x, y, z axis 3 times each)

## General notes

<b>Note on use</b>	The sensor head can be used with evaluation unit AOD1 or stand-alone via RS-485
<b>Note</b>	Not free of paint wetting impairment substances.

Classifications

<b>eCl@ss 5.0</b>	27270801
<b>eCl@ss 5.1.4</b>	27270801
<b>eCl@ss 6.0</b>	27270801
<b>eCl@ss 6.2</b>	27270801
<b>eCl@ss 7.0</b>	27270801
<b>eCl@ss 8.0</b>	27270801
<b>eCl@ss 8.1</b>	27270801
<b>eCl@ss 9.0</b>	27270801
<b>eCl@ss 10.0</b>	27270801
<b>eCl@ss 11.0</b>	27270801
<b>eCl@ss 12.0</b>	27270916
<b>ETIM 5.0</b>	EC001825
<b>ETIM 6.0</b>	EC001825
<b>ETIM 7.0</b>	EC001825
<b>ETIM 8.0</b>	EC001825
<b>UNSPSC 16.0901</b>	411111613

**Dimensional drawing** (Dimensions in mm (inch))

Stainless steel housing

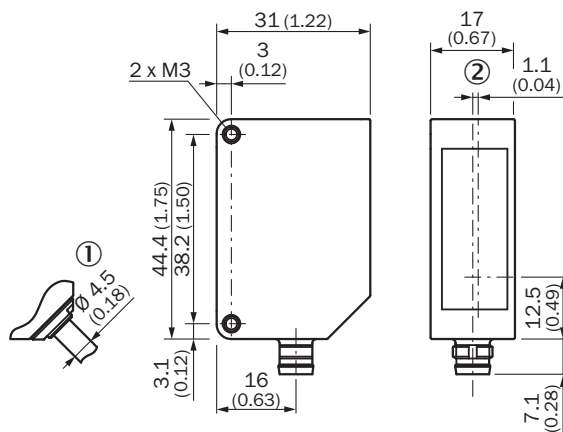

- ① Variant with 30 cm cable with M12, 5-pin connector
- ② Optical axis

**Connection type**

Connection type

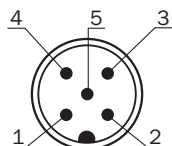

## Connection diagram

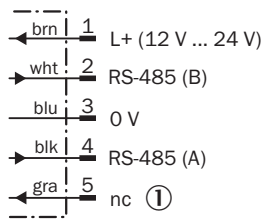

## Adjustment possible

Adjustments

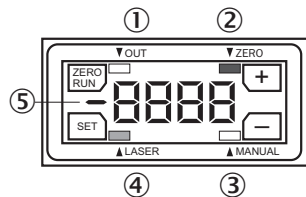

- ① Digital output status indicator
- ② Zero offset status indicator
- ③ Teach mode status indicator
- ④ Laser status indicator
- ⑤ Minus sign for measured value indicator

## Linearity

Linearity



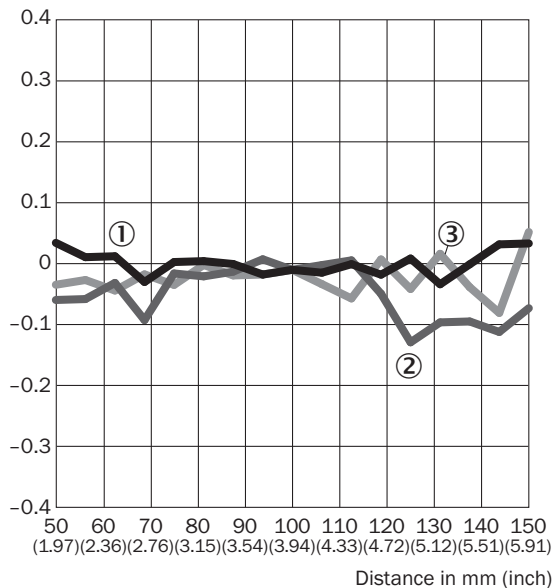

Linearity [% FS]



- ① White ceramic
- ② Stainless steel
- ③ Black rubber

### Recommended accessories

Other models and accessories → [www.sick.com/OD\\_Mini](http://www.sick.com/OD_Mini)

	Brief description	Type	Part no.
<b>Evaluation units</b>			
	OD Mini evaluation unit, master, 1 x Q, M8 male connector, 4-pin	AOD1-MR24Q1	6054270
	OD Mini evaluation unit, master, 2 x Q, M12 male connector, 5-pin	AOD1-MR25Q2	6054272
	OD Mini evaluation unit, OD5000 and OL1, master, 3 x Q, 1 x analog, open end cable, 2 m	AOD1-MR27C4	6058195
	OD Mini evaluation unit, slave, 1 x Q, M8 male connector, 4-pin	AOD1-SR24Q1	6054271
	OD Mini evaluation unit, slave, 2 x Q, M12 male connector, 5-pin	AOD1-SR25Q2	6054273
	OD Mini evaluation unit, OD5000 and OL1, slave, 3 x Q, 1 x analog, open end cable, 2 m	AOD1-SR27C4	6058196
<b>Mounting brackets and plates</b>			
	Mounting bracket, for wall installation, no alignment bracket, stainless steel	BEF-OD1-A	5328343
	Mounting bracket, no alignment bracket, stainless steel	BEF-OD1-B	5328344
<b>Plug connectors and cables</b>			
	Head A: female connector, M12, 5-pin, straight, A-coded Head B: Flying leads Cable: Sensor/actuator cable, PUR, halogen-free, unshielded, 2 m	YF2A15-020UB5XLEAX	2095617
	Head A: female connector, M12, 4-pin, straight Head B: male connector, M8, 4-pin Cable: Highly flexible, PUR, 2 m	DSL-2804-G02MB	6059743

### Recommended services

Additional services → [www.sick.com/OD\\_Mini](http://www.sick.com/OD_Mini)

	Type	Part no.
<b>Commissioning</b>		
<ul style="list-style-type: none"> <li>• <b>Product area:</b> Displacement measurement sensors</li> <li>• <b>Range of services:</b> Inspection of connection and mounting, optimization of parameters of SICK product as well as tests, set-up of previously defined functions of the scaling of the analog measuring range, switching point position, hysteresis, measuring frequency, measured value filter, signal quality, evaluation function, or communication interface</li> <li>• <b>Travel expenses:</b> The prices do not include travel costs such as hotel, flight, travel time and expenses.</li> <li>• <b>Duration:</b> Additional work will be invoiced separately</li> </ul>	DT20 Hi/OD/OL commissioning	1612241
<b>Extended warranty</b>		
<ul style="list-style-type: none"> <li>• <b>Product area:</b> Identification solutions, machine vision, Distance sensors, Detection and ranging solutions</li> <li>• <b>Range of services:</b> The services correspond to the scope of the statutory manufacturer warranty (SICK general terms of delivery).</li> <li>• <b>Duration:</b> Five-year warranty from delivery date.</li> </ul>	Extended warranty for a total of five years from delivery date	1680671

## SICK AT A GLANCE

SICK is one of the leading manufacturers of intelligent sensors and sensor solutions for industrial applications. A unique range of products and services creates the perfect basis for controlling processes securely and efficiently, protecting individuals from accidents and preventing damage to the environment.

We have extensive experience in a wide range of industries and understand their processes and requirements. With intelligent sensors, we can deliver exactly what our customers need. In application centers in Europe, Asia and North America, system solutions are tested and optimized in accordance with customer specifications. All this makes us a reliable supplier and development partner.

Comprehensive services complete our offering: SICK LifeTime Services provide support throughout the machine life cycle and ensure safety and productivity.

For us, that is “Sensor Intelligence.”

## WORLDWIDE PRESENCE:

Contacts and other locations –[www.sick.com](http://www.sick.com)