



OD1-B035H15I25

OD Mini

DISPLACEMENT MEASUREMENT SENSORS

SICK
Sensor Intelligence.



Ordering information

Type	Part no.
OD1-B035H15I25	6050504

Other models and accessories → www.sick.com/OD_Mini



Detailed technical data

Mechanics/electronics

Supply voltage V_s	DC 12 V (-5 %) ... DC 24 V (+10 %)
Power consumption	$\leq 1.92 \text{ W}^{1)}$
Warm-up time	$\leq 5 \text{ min}$
Housing material	Stainless steel
Window material	Plastic (PPSU)
Connection type	Cable with male connector, M12, 5-pin, 30 cm
Indication	4-digit 7-segment display (plus 4 LEDs for status display)
Control elements	4 buttons
Weight	70 g
Dimensions (W x H x D)	17.8 mm x 44.4 mm x 31 mm
Enclosure rating	IP67
Protection class	III

¹⁾ Without load, with current output.

Safety-related parameters

MTTF_D	101 years
DC_{avg}	0%

Performance

Measurement range min ... max:	20 mm ... 50 mm
Target	Natural objects

¹⁾ Averaging function set to: 512.

²⁾ Constant ambient conditions.

³⁾ Measurement on 90 % remission (ceramic, white).

⁴⁾ With fixed sensitivity adjustment and averaging setting = 1. With automatic sensitivity and measuring rate 500 μs : 2 ... 7.5 ms response time/measuring rate 1,000 μs : 4 ... 15 ms response time.

⁵⁾ Wavelength: 655 nm, max. output: 390 μW (laser class 1) / < 1 mW (laser class 2).

Repeatability	6 μm ^{1) 2)}
Linearity	$\pm 30 \mu\text{m}$ ³⁾
Response time	$\geq 2 \text{ ms}$ ⁴⁾
Measuring frequency	$\leq 2 \text{ kHz}$
Output time	$\geq 0.5 \text{ ms}$
Light source	Laser, red visible red light
Laser class	1 (IEC 60825-1:2014, EN 60825-1:2014) ⁵⁾
Typ. light spot size (distance)	800 μm x 450 μm (35 mm)
Additional function	Averaging 1 ... 512x, automatic or manual sensitivity adjustment, Analog outputs can be taught in, digital outputs can be taught in, invertable digital output, switching mode: window (Wnd), switching mode: distance to object (DtO), switching mode: object between sensor and background (ObSB), multifunctional input: laser-off / external teach-in / trigger

¹⁾ Averaging function set to: 512.

²⁾ Constant ambient conditions.

³⁾ Measurement on 90 % remission (ceramic, white).

⁴⁾ With fixed sensitivity adjustment and averaging setting = 1. With automatic sensitivity and measuring rate 500 μs : 2 ... 7.5 ms response time/measuring rate 1,000 μs : 4 ... 15 ms response time.

⁵⁾ Wavelength: 655 nm, max. output: 390 μW (laser class 1) / < 1 mW (laser class 2).

Interfaces

Digital output	Number	1
	Type	PNP/NPN, selectable
Analog output	Number	1
	Type	Current output
	Current	4 mA ... 20 mA, $\leq 300 \Omega$
	Resolution	13.4 bit
Multifunctional input (MF)		1 x ¹⁾

¹⁾ MF can be used as laser-off, trigger, external teach-in or deactivated.

Ambient data

Ambient temperature, operation	-10 °C ... +50 °C
Ambient temperature, storage	-20 °C ... +60 °C
Min. rel. humidity (not condensing)	35 %
Max. rel. humidity (not condensing)	95 %
Temperature drift	$\pm 0.08 \%$ FS/K (FS = Full Scale = Measuring range of sensor)
Typ. Ambient light immunity	Artificial light: $\leq 3,000 \text{ lx}$ Sunlight: $\leq 10,000 \text{ lx}$
Vibration resistance	10 Hz ... 55 Hz (amplitude 1.5 mm, x-, y-, z-axis 2 hours each)
Shock resistance	50 G (x, y, z axis 3 times each)

General notes

Note	Not free of paint wetting impairment substances.
-------------	--

Classifications

eCl@ss 5.0	27270801
-------------------	----------

eCl@ss 5.1.4	27270801
eCl@ss 6.0	27270801
eCl@ss 6.2	27270801
eCl@ss 7.0	27270801
eCl@ss 8.0	27270801
eCl@ss 8.1	27270801
eCl@ss 9.0	27270801
eCl@ss 10.0	27270801
eCl@ss 11.0	27270801
eCl@ss 12.0	27270916
ETIM 5.0	EC001825
ETIM 6.0	EC001825
ETIM 7.0	EC001825
ETIM 8.0	EC001825
UNSPSC 16.0901	411111613

Dimensional drawing (Dimensions in mm (inch))

Stainless steel housing

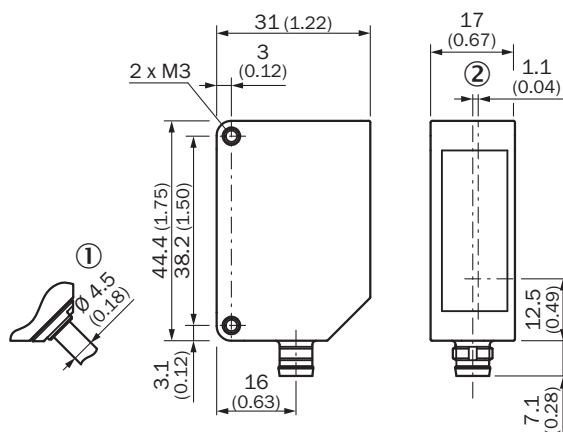

- ① Variant with 30 cm cable with M12, 5-pin connector
- ② Optical axis

Connection type

Connection type

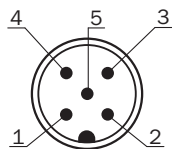

Connection diagram

Connection diagram

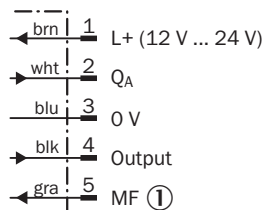

① Multifunctional input (MF)

Adjustment possible

Adjustments

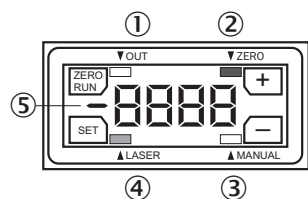

- ① Digital output status indicator
- ② Zero offset status indicator
- ③ Teach mode status indicator
- ④ Laser status indicator
- ⑤ Minus sign for measured value indicator

Light spot size

OD Mini Prime 20 mm ... 50 mm

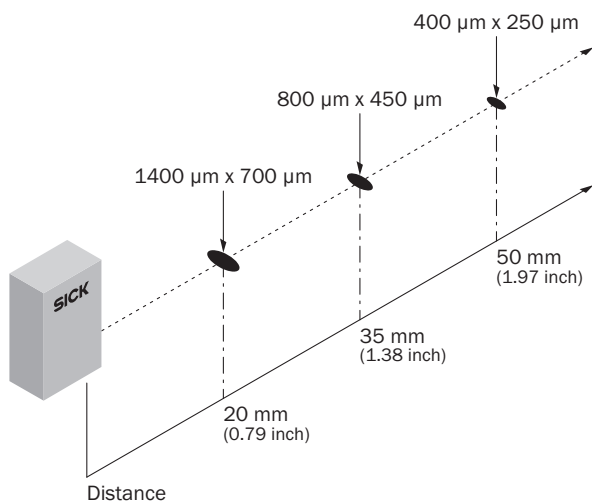

Linearity

Linearity



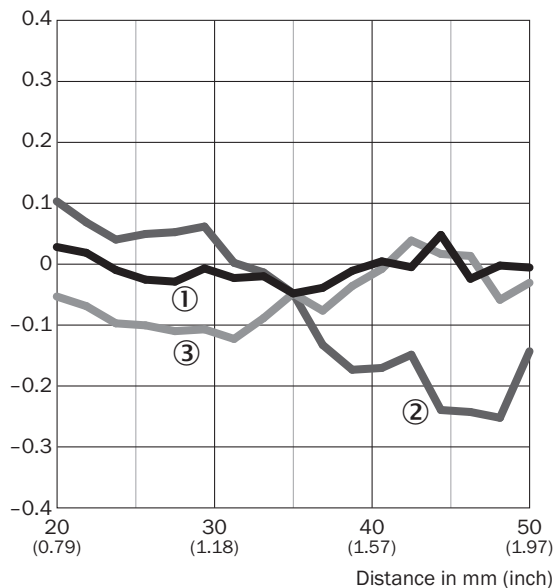

Linearity [% FS]



- ① White ceramic
- ② Stainless steel
- ③ Black rubber

Recommended accessories

Other models and accessories → www.sick.com/OD_Mini

	Brief description	Type	Part no.
Mounting brackets and plates			
	Mounting bracket, for wall installation, no alignment bracket, stainless steel	BEF-OD1-A	5328343
	Mounting bracket, no alignment bracket, stainless steel	BEF-OD1-B	5328344
Plug connectors and cables			
	Head A: female connector, M12, 5-pin, straight, A-coded Head B: Flying leads Cable: Sensor/actuator cable, PUR, halogen-free, unshielded, 2 m	YF2A15-020UB5XLEAX	2095617
	Head A: female connector, M12, 4-pin, straight Head B: male connector, M8, 4-pin Cable: Highly flexible, PUR, 2 m	DSL-2804-G02MB	6059743
	Head A: female connector, M12, 4-pin, straight, A-coded Head B: male connector, M8, 4-pin, straight, A-coded Cable: Sensor/actuator cable, PUR, halogen-free, unshielded, 2 m	YF2A14-020UA3M8U14	2096112

Recommended services

Additional services → www.sick.com/OD_Mini

	Type	Part no.
Commissioning		
<ul style="list-style-type: none"> • Product area: Displacement measurement sensors • Range of services: Inspection of connection and mounting, optimization of parameters of SICK product as well as tests, set-up of previously defined functions of the scaling of the analog measuring range, switching point position, hysteresis, measuring frequency, measured value filter, signal quality, evaluation function, or communication interface • Travel expenses: The prices do not include travel costs such as hotel, flight, travel time and expenses. • Duration: Additional work will be invoiced separately 	DT20 Hi/OD/OL commissioning	1612241
Extended warranty		
<ul style="list-style-type: none"> • Product area: Identification solutions, machine vision, Distance sensors, Detection and ranging solutions • Range of services: The services correspond to the scope of the statutory manufacturer warranty (SICK general terms of delivery). • Duration: Five-year warranty from delivery date. 	Extended warranty for a total of five years from delivery date	1680671

SICK AT A GLANCE

SICK is one of the leading manufacturers of intelligent sensors and sensor solutions for industrial applications. A unique range of products and services creates the perfect basis for controlling processes securely and efficiently, protecting individuals from accidents and preventing damage to the environment.

We have extensive experience in a wide range of industries and understand their processes and requirements. With intelligent sensors, we can deliver exactly what our customers need. In application centers in Europe, Asia and North America, system solutions are tested and optimized in accordance with customer specifications. All this makes us a reliable supplier and development partner.

Comprehensive services complete our offering: SICK LifeTime Services provide support throughout the machine life cycle and ensure safety and productivity.

For us, that is “Sensor Intelligence.”

WORLDWIDE PRESENCE:

Contacts and other locations –www.sick.com