



# WLG12-V537

WLG

SWITCHING AUTOMATION LIGHT GRIDS

**SICK**  
Sensor Intelligence.



Illustration may differ



### Ordering information

Type	Part no.
WLG12-V537	1016045

Other models and accessories → [www.sick.com/WLG](http://www.sick.com/WLG)

### Detailed technical data

#### Features

<b>Sensor principle</b>	Photoelectric retro-reflective sensor
<b>Minimum detectable object (MDO)</b>	Parallel beam, 6 mm ... 12.5 mm
<b>Beam separation</b>	12.5 mm
<b>Number of beams</b>	8
<b>Detection height</b>	87.5 mm
<b>Resolution (adjustable)</b>	6 mm ... 12.5 mm <sup>1)</sup>

<sup>1)</sup> Dependence of the range.

#### Mechanics/electronics

<b>Wave length</b>	650 nm
<b>Supply voltage V<sub>s</sub></b>	DC 18 V ... 30 V <sup>1)</sup>
<b>Power consumption sender</b>	80 mA
<b>Ripple</b>	< 5 V <sub>pp</sub>
<b>Output current I<sub>max.</sub></b>	≤ 100 mA
<b>Output load, capacitive</b>	100 nF
<b>Output load, Inductive</b>	1 H
<b>Initialization time</b>	0.6 s
<b>Switching output</b>	PNP <sup>2)</sup>
<b>Output mode</b>	Q dark switching <sup>3)</sup>
<b>Teach-in input</b>	PNP
<b>Dimensions (W x H x D)</b>	62 mm x 106 mm x 46.6 mm
<b>Connection type</b>	Male connector M12, 5-pin
<b>Housing material</b>	Plastic

<sup>1)</sup> Typical value.

<sup>2)</sup>  $\bar{Q}$ .

<sup>3)</sup> Q = active, if at least one beam is interrupted, /Q = active, if all of the beams are free.

<b>Indication</b>	LED
<b>Enclosure rating</b>	IP67
<b>Circuit protection</b>	U <sub>V</sub> connections, reverse polarity protected Output Q short-circuit protected Interference pulse suppression
<b>Protection class</b>	II
<b>Weight</b>	230 g
<b>Front screen</b>	PMMA

<sup>1)</sup> Typical value.

<sup>2)</sup>  $\dot{Q}$ .

<sup>3)</sup> Q = active, if at least one beam is interrupted, /Q = active, if all of the beams are free.

## Performance

<b>Maximum range</b>	1.5 m
<b>Minimum range</b>	≥ 100 mm
<b>Operating range</b>	1.5 m
<b>Response time</b>	Parallel beam, 0.6 ms <sup>1)</sup>

<sup>1)</sup> With resistive load.

## Ambient data

<b>Enclosure rating</b>	IP67
<b>Shock resistance</b>	10 g / DIN EN 60068-2-29 / 16 ms
<b>Vibration resistance</b>	5 g, 10 Hz ... 55 Hz (IEC 68-2-6)
<b>EMC</b>	EN 60947-5-2
<b>Ambient operating temperature</b>	-25 °C ... +55 °C
<b>Ambient temperature, storage</b>	-20 °C ... +70 °C

## Classifications

<b>ECl@ss 5.0</b>	27270910
<b>ECl@ss 5.1.4</b>	27270910
<b>ECl@ss 6.0</b>	27270910
<b>ECl@ss 6.2</b>	27270910
<b>ECl@ss 7.0</b>	27270910
<b>ECl@ss 8.0</b>	27270910
<b>ECl@ss 8.1</b>	27270910
<b>ECl@ss 9.0</b>	27270910
<b>ECl@ss 10.0</b>	27270910
<b>ECl@ss 11.0</b>	27270910
<b>ETIM 5.0</b>	EC002549
<b>ETIM 6.0</b>	EC002549
<b>ETIM 7.0</b>	EC002549
<b>UNSPSC 16.0901</b>	39121528

### Dimensional drawing (Dimensions in mm (inch))

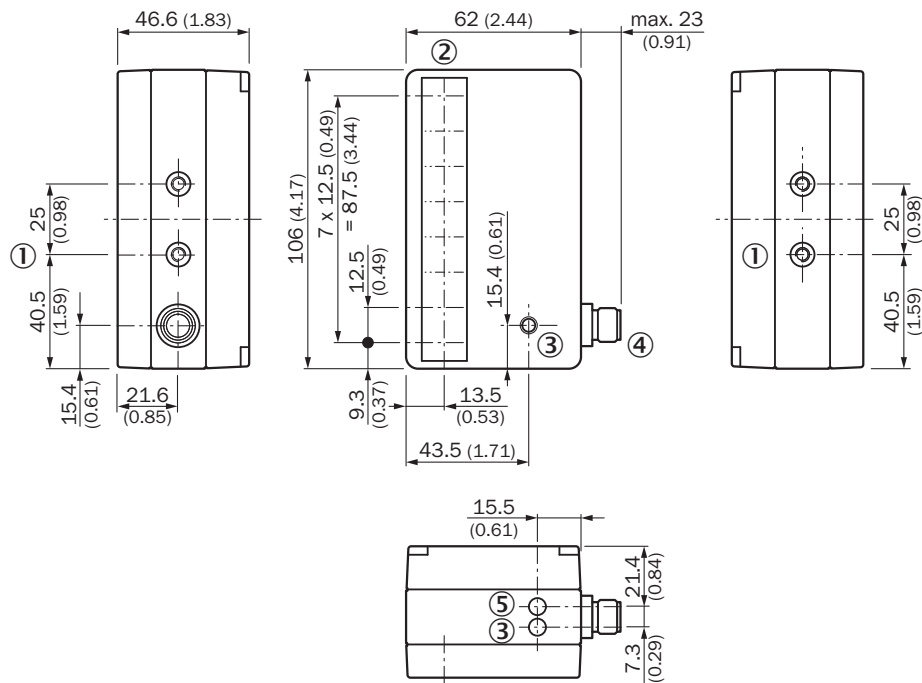

- ① M5 threaded mounting hole, 6 mm deep
- ② Optic
- ③ Multifunctional display front and top: receive indicator, output weak signal, error during teach-in
- ④ M12 male connector, 5-pin or 2 m cable
- ⑤ Operating indicator

### Adjustments

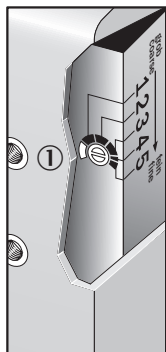

#### Choice of sensitivity range, dimensions in mm/m (inch)

Potentiometer setting	Resolution	Working range	Reflector
1	> 12.5 mm (0.49)	1.5 m (59.06)	2 x PL80A/PL40A
2	> 10 mm (0.39)	1.2 m (47.24)	2 x PL80A/PL40A
3	> 9 mm (0.35)	1.0 m (39.37)	PL180E01
4	> 7 mm (0.28)	0.8 m (31.50)	PL180E01
5	> 6 mm (0.24)	0.4 m (15.75)	PL180E01

- ① Potentiometer for sensitivity adjustment



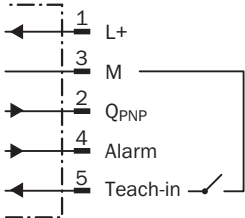
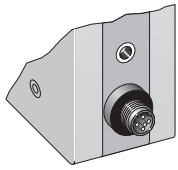

### Connection type and diagram

Connection type and diagram



### Recommended accessories

Other models and accessories → [www.sick.com/WLG](http://www.sick.com/WLG)

	Brief description	Type	Part no.
<b>Mounting brackets and plates</b>			
	<ul style="list-style-type: none"> <li><b>Description:</b> Mounting bracket</li> <li><b>Material:</b> Steel</li> <li><b>Items supplied:</b> Mounting hardware included</li> </ul>	BEF-WN-WLG12	2017567
<b>Plug connectors and cables</b>			
	<ul style="list-style-type: none"> <li><b>Connection type head A:</b> Female connector, M12, 5-pin, angled, A-coded</li> <li><b>Connection type head B:</b> Flying leads</li> <li><b>Authorizations:</b> CE, UL</li> <li><b>Signal type:</b> Sensor/actuator cable</li> <li><b>Cable:</b> 5 m, 5-wire, PVC</li> <li><b>Description:</b> Sensor/actuator cable, unshielded</li> <li><b>Application:</b> Zones with chemicals</li> </ul>	YG2A15-050VB5XLEAX	2096216
	<ul style="list-style-type: none"> <li><b>Connection type head A:</b> Female connector, M12, 5-pin, straight</li> <li><b>Authorizations:</b> UL</li> <li><b>Description:</b> Unshielded, Head A: female connector, M12, 5-pin, straight, unshielded, for cable diameter 4 mm ... 6 mm Head B: -</li> <li><b>Connection systems:</b> Screw-type terminals</li> <li><b>Permitted cross-section:</b> ≤ 0.75 mm²</li> </ul>	DOS-1205-G	6009719
<b>Reflectors</b>			
	<ul style="list-style-type: none"> <li><b>Description:</b> Reflector, rectangular, screw connection</li> <li><b>Dimensions:</b> 40 mm 180 mm</li> <li><b>Ambient operating temperature:</b> -20 °C ... +65 °C</li> </ul>	PL180E01	1013289

## SICK AT A GLANCE

SICK is one of the leading manufacturers of intelligent sensors and sensor solutions for industrial applications. A unique range of products and services creates the perfect basis for controlling processes securely and efficiently, protecting individuals from accidents and preventing damage to the environment.

We have extensive experience in a wide range of industries and understand their processes and requirements. With intelligent sensors, we can deliver exactly what our customers need. In application centers in Europe, Asia and North America, system solutions are tested and optimized in accordance with customer specifications. All this makes us a reliable supplier and development partner.

Comprehensive services complete our offering: SICK LifeTime Services provide support throughout the machine life cycle and ensure safety and productivity.

For us, that is “Sensor Intelligence.”

## WORLDWIDE PRESENCE:

Contacts and other locations –[www.sick.com](http://www.sick.com)