



TiM561-2050101

TiM

2D LIDAR SENSORS

**SICK**  
Sensor Intelligence.



### Ordering information

Type	Part no.
TiM561-2050101	1071419

Other models and accessories → [www.sick.com/TiM](http://www.sick.com/TiM)



### Detailed technical data

#### Features

<b>Measurement principle</b>	HDDM <sup>+</sup>
<b>Application</b>	Outdoor
<b>Light source</b>	Infrared (850 nm)
<b>Laser class</b>	1 (IEC 60825-1:2014, EN 60825-1:2014)
<b>Aperture angle</b>	Horizontal 270°
<b>Scanning frequency</b>	15 Hz
<b>Angular resolution</b>	0.33°
<b>Working range</b>	0.05 m ... 10 m
<b>Scanning range</b>	At 10% remission factor 8 m

#### Mechanics/electronics

<b>Connection type</b>	1 x "Ethernet" connection, 4-pin M12 female connector 1 x connection "Power/Synchronization output" 5-pin, M12 male connector 1 x Micro USB female connector, type B
<b>Supply voltage</b>	9 V DC ... 28 V DC
<b>Power consumption</b>	Typ. 4 W
<b>Output current</b>	≤ 100 mA
<b>Housing color</b>	Gray (RAL 7032)
<b>Enclosure rating</b>	IP67, applies only when the plastic cover of the "Aux interface" is closed (IEC 60529:1989+AMD1:1999+AMD2:2013)
<b>Protection class</b>	III (IEC 61140:2016-1)
<b>Weight</b>	250 g, without connecting cables
<b>Dimensions (L x W x H)</b>	60 mm x 60 mm x 86 mm
<b>MTBF</b>	> 100 years

## Safety-related parameters

<b>MTTF<sub>D</sub></b>	100 years
-------------------------	-----------

## Performance

<b>Response time</b>	1 scan, typ. 67 ms 2 scans, ≤ 134 ms <sup>1)</sup>
<b>Detectable object shape</b>	Almost any
<b>Systematic error</b>	± 60 mm <sup>2)</sup>
<b>Statistical error</b>	< 20 mm <sup>2)</sup>
<b>Integrated application</b>	Output of measurement data

<sup>1)</sup> At +45° to +225° of the working range; max. 150 ms at -45° to +45° of the working range.

<sup>2)</sup> Typical value at 90% remission up to maximum scanning range; real value depends on ambient conditions.

## Interfaces

<b>Ethernet</b>	✓, TCP/IP
<b>USB</b>	✓
Remark	Micro USB
Function	Service interface, parameterization
<b>Digital inputs</b>	0
<b>Digital outputs</b>	1 (PNP, "SYNC"/"device ready")
<b>Optical indicators</b>	2 LEDs (ON, "device ready")

## Ambient data

<b>Object remission</b>	4 % ... 1,000 % (reflectors)
<b>Electromagnetic compatibility (EMC)</b>	
Emitted radiation	Residential area (EN 61000-6-3:2007+AMD:A1:2011)
Electromagnetic immunity	Industrial environment (EN 61000-6-2:2005)
<b>Vibration resistance</b>	
Sine resonance scan	10 Hz ... 1,000 Hz <sup>1)</sup>
Sine test	10 Hz ... 500 Hz, 5 g, 10 frequency cycles <sup>1)</sup>
Noise test	10 Hz ... 250 Hz, 4.24 g RMS, 5 h <sup>2)</sup>
<b>Shock resistance</b>	50 g, 11 ms, ± 3 single shocks/axis <sup>3)</sup> 25 g, 6 ms, ± 1,000 continuous shocks/axis <sup>3)</sup> 50 g, 3 ms, ± 5,000 continuous shocks/axis <sup>3)</sup>
<b>Ambient operating temperature</b>	-25 °C ... +50 °C <sup>4)</sup>
<b>Storage temperature</b>	-40 °C ... +75 °C <sup>4)</sup>
<b>Temperature change</b>	-25 °C ... +50 °C, 10 cycles <sup>5)</sup>
<b>Damp heat</b>	+25 °C ... +55 °C, 95 % RH, 6 cycles <sup>6)</sup>
<b>Permissible relative humidity</b>	

<sup>1)</sup> IEC 60068-2-6:2007.

<sup>2)</sup> IEC 60068-2-64:2008.

<sup>3)</sup> IEC 60068-2-27:2008.

<sup>4)</sup> IEC 60068-2-14:2009.

<sup>5)</sup> EN 60068-2-14:2009.

<sup>6)</sup> EN 60068-2-30:2005.

	Operation	< 80 %, Non-condensing (EN 60068-2-30:2005)
	Storage	≤ 95 %, Non-condensing (EN 60068-2-30:2005)
<b>Ambient light immunity</b>		80,000 lx

- <sup>1)</sup> IEC 60068-2-6:2007.
- <sup>2)</sup> IEC 60068-2-64:2008.
- <sup>3)</sup> IEC 60068-2-27:2008.
- <sup>4)</sup> IEC 60068-2-14:2009.
- <sup>5)</sup> EN 60068-2-14:2009.
- <sup>6)</sup> EN 60068-2-30:2005.

General notes

<b>Note on use</b>	The sensor does not constitute a safety component as defined by relevant legislation on machine safety.
--------------------	---

Classifications

<b>ECLASS 5.0</b>	27270990
<b>ECLASS 5.1.4</b>	27270990
<b>ECLASS 6.0</b>	27270913
<b>ECLASS 6.2</b>	27270913
<b>ECLASS 7.0</b>	27270913
<b>ECLASS 8.0</b>	27270913
<b>ECLASS 8.1</b>	27270913
<b>ECLASS 9.0</b>	27270913
<b>ECLASS 10.0</b>	27270913
<b>ECLASS 11.0</b>	27270913
<b>ECLASS 12.0</b>	27270913
<b>ETIM 5.0</b>	EC002550
<b>ETIM 6.0</b>	EC002550
<b>ETIM 7.0</b>	EC002550
<b>ETIM 8.0</b>	EC002550
<b>UNSPSC 16.0901</b>	41111615

Dimensional drawing (Dimensions in mm (inch))

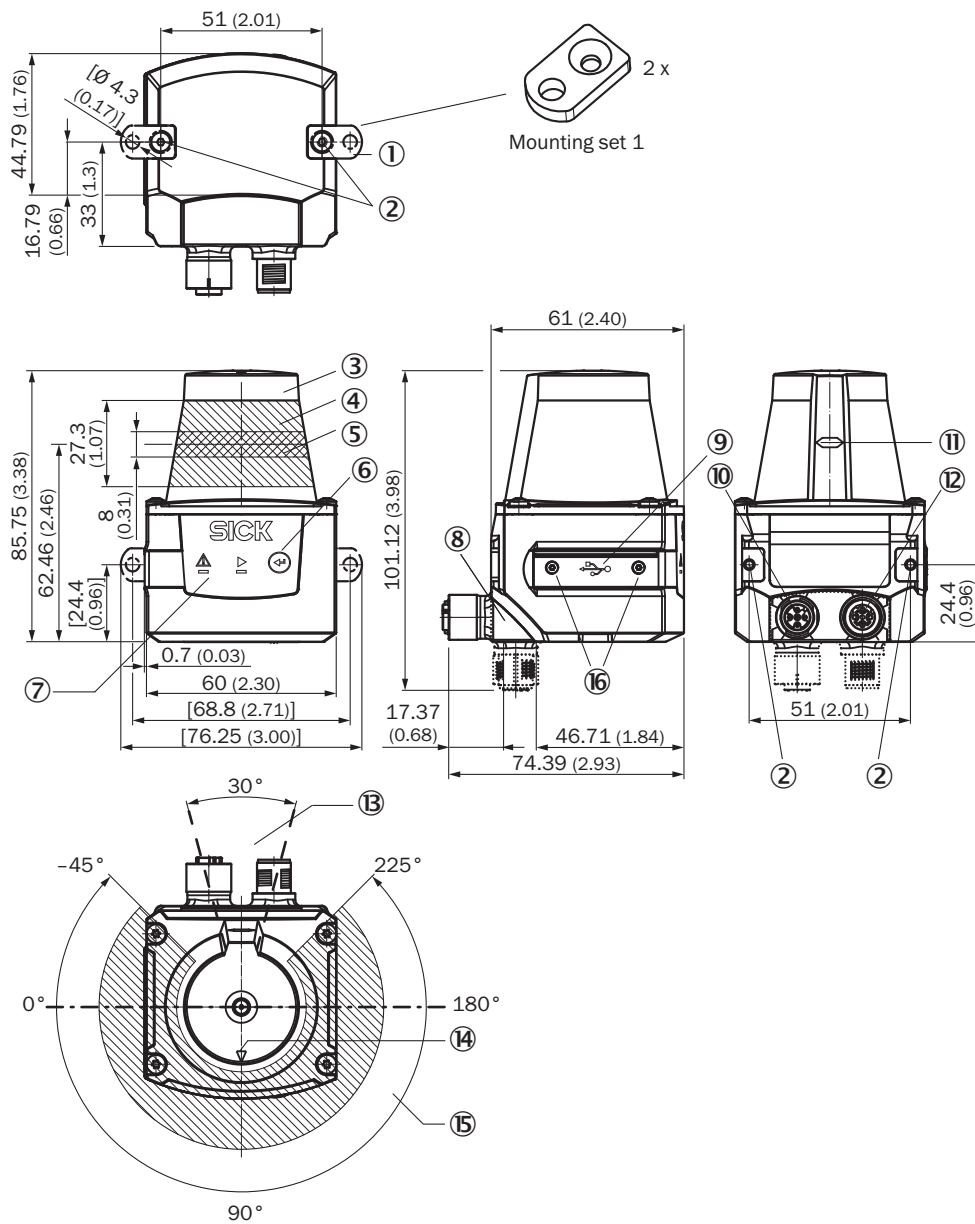

- ① 2 x straight plates with M3 x 4 mm screw (included in delivery)
- ② M3 threaded mounting hole, 2.8 mm deep (blind hole thread), max. tightening torque 0.8 Nm
- ③ Optical hood
- ④ Receiving range (light inlet)
- ⑤ Transmission range (light emission)
- ⑥ Push-button (no function)
- ⑦ Red and green LED (status displays)
- ⑧ Swivel connector unit
- ⑨ Micro USB female connector, type B
- ⑩ Connection "Power/Synchronization output" 5-pin, M12 male connector
- ⑪ Marking for the position of the light emission level
- ⑫ "Ethernet" connection, 4-pin M12 female connector
- ⑬ Area in which no reflective surfaces are allowed for mounted devices
- ⑭ Bearing marking to support alignment (90° axis)
- ⑮ Aperture angle 270° (scanning angle)
- ⑯ 2 x countersunk screw (Torx TX 6) M2 x 4 mm

### Working range diagram

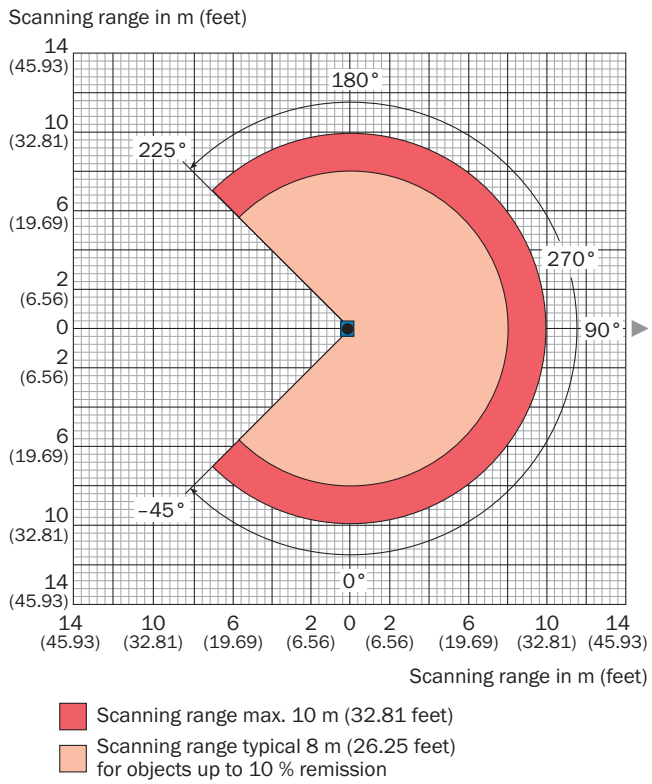

### Connection type

Ethernet

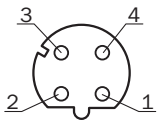

M12 female connector, 4-pin, D-coded

- ① TX+
- ② RX+
- ③ TX-
- ④ RX-

## PIN assignment

Power

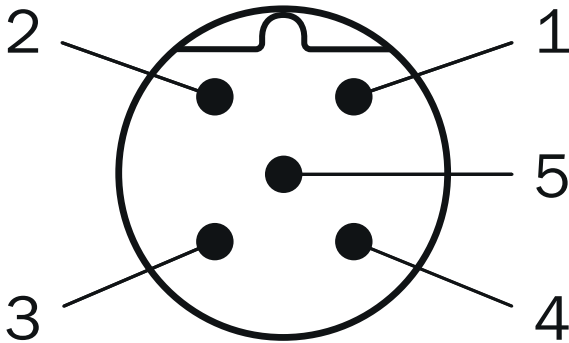





Connector M12, 5-pin, A-coded

- ① DC 9 V ... 28 V
- ② "SYNC"/"device ready"
- ③ GND
- ④ nc
- ⑤ nc

## Recommended accessories

Other models and accessories → [www.sick.com/TiM](http://www.sick.com/TiM)

	Brief description	Type	Part no.
Mounting brackets and plates			
	Mounting kit with shock absorber, Anodized aluminum, mounting hardware included	Mounting kit	2086074
Plug connectors and cables			
	<ul style="list-style-type: none"> <li>• <b>Connection type head A:</b> Female connector, M12, 5-pin, straight, A-coded</li> <li>• <b>Connection type head B:</b> Flying leads</li> <li>• <b>Signal type:</b> Power</li> <li>• <b>Cable:</b> 5 m, 4-wire, PUR, halogen-free</li> <li>• <b>Description:</b> Power, shielded</li> <li>• <b>Connection systems:</b> Flying leads</li> </ul>	YF2A64-050XXXLEAX	6036159
	<ul style="list-style-type: none"> <li>• <b>Connection type head A:</b> Male connector, USB-A</li> <li>• <b>Connection type head B:</b> Male connector, Micro-B</li> <li>• <b>Signal type:</b> USB 2.0</li> <li>• <b>Cable:</b> 2 m</li> <li>• <b>Description:</b> USB 2.0, unshielded</li> </ul>	USB cable	6036106
	<ul style="list-style-type: none"> <li>• <b>Connection type head A:</b> Male connector, M12, 4-pin, straight, D-coded</li> <li>• <b>Connection type head B:</b> Male connector, RJ45, 8-pin, straight</li> <li>• <b>Signal type:</b> Ethernet</li> <li>• <b>Cable:</b> 5 m, 4-wire, AWG26</li> <li>• <b>Description:</b> Ethernet, shielded</li> </ul>	YM2D24-050EB2MRJA4	6050200

Recommended services

Additional services → [www.sick.com/TiM](http://www.sick.com/TiM)

	Type	Part no.
Maintenance		
<ul style="list-style-type: none"> <li>• <b>Product area:</b> 2D LiDAR sensors, 3D LiDAR sensors</li> <li>• <b>Range of services:</b> Inspection, analysis and restoring of defined functions, Inspection and adaptation of basic settings, parameters of field application, filters for raw data output, and product-specific configuration</li> <li>• <b>Duration:</b> Additional work will be invoiced separately</li> <li>• <b>Travel expenses:</b> The prices do not include travel costs such as hotel, flight, travel time and expenses.</li> </ul>	Maintenance of LiDAR sensors	1682593
Commissioning		
<ul style="list-style-type: none"> <li>• <b>Product area:</b> 2D LiDAR sensors, 3D LiDAR sensors</li> <li>• <b>Range of services:</b> Inspection of connection, fine adjustment, configuration of monitored areas, configuration and optimization of parameters as well as tests, Setup of previously defined functions of basic settings, parameters of field application, filters for raw data output and product-specific configuration</li> <li>• <b>Travel expenses:</b> The prices do not include travel costs such as hotel, flight, travel time and expenses.</li> <li>• <b>Duration:</b> Additional work will be invoiced separately</li> </ul>	Commissioning LiDAR sensors	1680672
Extended warranty		
<ul style="list-style-type: none"> <li>• <b>Product area:</b> Identification solutions, machine vision, Detection and ranging solutions, safety camera sensors, Safety laser scanners, Safety radar sensors</li> <li>• <b>Range of services:</b> The services correspond to the scope of the statutory manufacturer warranty (SICK general terms of delivery).</li> <li>• <b>Duration:</b> Five-year warranty from delivery date.</li> </ul>	Extended warranty for a total of five years from delivery date	1680671

## SICK AT A GLANCE

SICK is one of the leading manufacturers of intelligent sensors and sensor solutions for industrial applications. A unique range of products and services creates the perfect basis for controlling processes securely and efficiently, protecting individuals from accidents and preventing damage to the environment.

We have extensive experience in a wide range of industries and understand their processes and requirements. With intelligent sensors, we can deliver exactly what our customers need. In application centers in Europe, Asia and North America, system solutions are tested and optimized in accordance with customer specifications. All this makes us a reliable supplier and development partner.

Comprehensive services complete our offering: SICK LifeTime Services provide support throughout the machine life cycle and ensure safety and productivity.

For us, that is “Sensor Intelligence.”

## WORLDWIDE PRESENCE:

Contacts and other locations –[www.sick.com](http://www.sick.com)