



# WTB8L-N2231

W8 Laser

MINIATURE PHOTOELECTRIC SENSORS

**SICK**  
Sensor Intelligence.



Illustration may differ



## Ordering information

Type	Part no.
WTB8L-N2231	6033220

**Included in delivery:** BEF-W100-A (1)

Other models and accessories → [www.sick.com/W8\\_Laser](http://www.sick.com/W8_Laser)

## Detailed technical data

### Features

<b>Functional principle</b>	Photoelectric proximity sensor
<b>Functional principle detail</b>	Background suppression
<b>Dimensions (W x H x D)</b>	11 mm x 31 mm x 20 mm
<b>Housing design (light emission)</b>	Rectangular
<b>Sensing range max.</b>	30 mm ... 300 mm <sup>1)</sup>
<b>Sensing range</b>	40 mm ... 300 mm <sup>1)</sup>
<b>Type of light</b>	Visible red light
<b>Light source</b>	Laser <sup>2)</sup>
<b>Light spot size (distance)</b>	Ø 1.5 mm (300 mm)
<b>Wave length</b>	650 nm
<b>Laser class</b>	1
<b>Adjustment</b>	Potentiometer, 4 turns
<b>Special applications</b>	Detecting small objects, Detection of objects moving at high speeds
<b>Test input sender off</b>	TE to 0 V

<sup>1)</sup> Object with 90% remission (based on standard white, DIN 5033).

<sup>2)</sup> Average service life: 100,000 h at T<sub>U</sub> = +25 °C.

### Mechanics/electronics

<b>Supply voltage</b>	10 V DC ... 30 V DC <sup>1)</sup>
-----------------------	-----------------------------------

<sup>1)</sup> Limit values when operated in short-circuit protected network: max. 8 A.

<sup>2)</sup> May not exceed or fall below U<sub>y</sub> tolerances.

<sup>3)</sup> Without load.

<sup>4)</sup> Signal transit time with resistive load.

<sup>5)</sup> With light/dark ratio 1:1.

<sup>6)</sup> A = V<sub>S</sub> connections reverse-polarity protected.

<sup>7)</sup> B = inputs and output reverse-polarity protected.

<sup>8)</sup> D = outputs overcurrent and short-circuit protected.

<b>Ripple</b>	± 10 % <sup>2)</sup>
<b>Current consumption</b>	30 mA <sup>3)</sup>
<b>Switching output</b>	NPN
<b>Switching mode</b>	Light/dark switching
<b>Switching mode selector</b>	Selectable via light/dark rotary switch
<b>Signal voltage NPN HIGH/LOW</b>	Approx. $V_S / < 1.8$ V
<b>Output current <math>I_{max}</math></b>	≤ 100 mA
<b>Response time</b>	≤ 0.25 ms <sup>4)</sup>
<b>Switching frequency</b>	2,000 Hz <sup>5)</sup>
<b>Connection type</b>	Male connector M8, 4-pin
<b>Circuit protection</b>	A <sup>6)</sup> B <sup>7)</sup> D <sup>8)</sup>
<b>Weight</b>	10 g
<b>Housing material</b>	Plastic, ABS
<b>Optics material</b>	Plastic, PMMA
<b>Enclosure rating</b>	IP67
<b>Items supplied</b>	Stainless steel mounting bracket (1.4301/304) BEF-W100-A
<b>Ambient operating temperature</b>	-10 °C ... +50 °C
<b>Ambient temperature, storage</b>	-40 °C ... +70 °C

<sup>1)</sup> Limit values when operated in short-circuit protected network: max. 8 A.

<sup>2)</sup> May not exceed or fall below  $U_V$  tolerances.

<sup>3)</sup> Without load.

<sup>4)</sup> Signal transit time with resistive load.

<sup>5)</sup> With light/dark ratio 1:1.

<sup>6)</sup> A =  $V_S$  connections reverse-polarity protected.

<sup>7)</sup> B = inputs and output reverse-polarity protected.

<sup>8)</sup> D = outputs overcurrent and short-circuit protected.

### Safety-related parameters

<b>MTTF<sub>D</sub></b>	477 years
<b>DC<sub>avg</sub></b>	0 %

### Classifications

<b>eCl@ss 5.0</b>	27270904
<b>eCl@ss 5.1.4</b>	27270904
<b>eCl@ss 6.0</b>	27270904
<b>eCl@ss 6.2</b>	27270904
<b>eCl@ss 7.0</b>	27270904
<b>eCl@ss 8.0</b>	27270904
<b>eCl@ss 8.1</b>	27270904
<b>eCl@ss 9.0</b>	27270904
<b>eCl@ss 10.0</b>	27270904
<b>eCl@ss 11.0</b>	27270904

<b>eCl@ss 12.0</b>	27270903
<b>ETIM 5.0</b>	EC002719
<b>ETIM 6.0</b>	EC002719
<b>ETIM 7.0</b>	EC002719
<b>ETIM 8.0</b>	EC002719
<b>UNSPSC 16.0901</b>	39121528

### Connection type

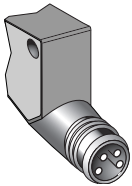

### Connection diagram

Cd-078

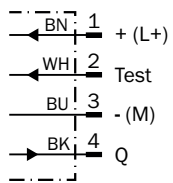

Characteristic curve

WTB8L, 300 mm

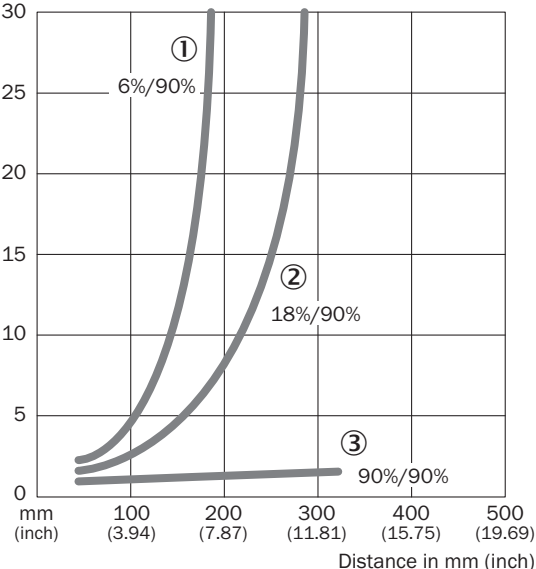

- ① Sensing range on black, 6% remission
- ② Sensing range on gray, 18 % remission
- ③ Sensing range on white, 90% remission

Sensing range diagram

WTB8, 300 mm

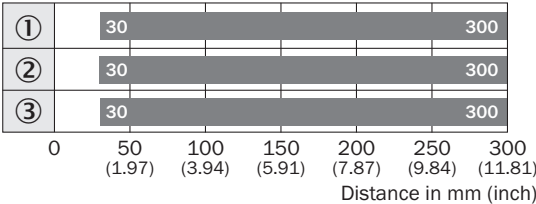

- Sensing range
- ① Sensing range on black, 6% remission
- ② Sensing range on gray, 18 % remission
- ③ Sensing range on white, 90% remission

## Adjustments

WTB8

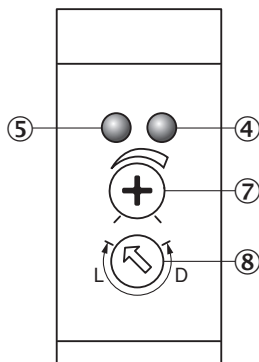

- ④ Orange LED indicator : switching output active
- ⑤ LED indicator green: stability indicator
- ⑦ Adjustment of sensing range
- ⑧ Light/ dark rotary switch: L = light switching, D = dark switching

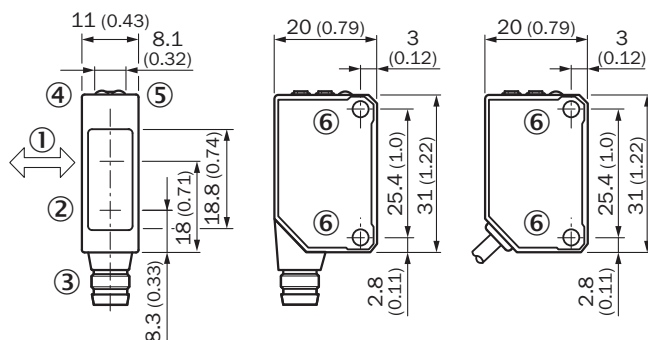

## Dimensional drawing (Dimensions in mm (inch))



- ① Standard direction
- ② Center of optical axis, sender
- ③ Connection
- ④ Orange LED indicator : switching output active
- ⑤ LED indicator green: stability indicator
- ⑥ Threaded mounting hole M3

## Recommended accessories

Other models and accessories → [www.sick.com/W8\\_Laser](http://www.sick.com/W8_Laser)

	Brief description	Type	Part no.
Plug connectors and cables			
	Head A: female connector, M8, 4-pin, straight, A-coded Head B: Flying leads Cable: Sensor/actuator cable, PVC, unshielded, 5 m	YF8U14-050VA3XLEAX	2095889
	Head A: male connector, M8, 4-pin, straight Cable: unshielded	STE-0804-G	6037323

## SICK AT A GLANCE

SICK is one of the leading manufacturers of intelligent sensors and sensor solutions for industrial applications. A unique range of products and services creates the perfect basis for controlling processes securely and efficiently, protecting individuals from accidents and preventing damage to the environment.

We have extensive experience in a wide range of industries and understand their processes and requirements. With intelligent sensors, we can deliver exactly what our customers need. In application centers in Europe, Asia and North America, system solutions are tested and optimized in accordance with customer specifications. All this makes us a reliable supplier and development partner.

Comprehensive services complete our offering: SICK LifeTime Services provide support throughout the machine life cycle and ensure safety and productivity.

For us, that is “Sensor Intelligence.”

## WORLDWIDE PRESENCE:

Contacts and other locations –[www.sick.com](http://www.sick.com)