



IM08-01B-N-ZW0

IMN

INDUCTIVE PROXIMITY SENSORS

SICK
Sensor Intelligence.



Ordering information

Type	Part no.
IM08-01B-N-ZW0	6021123

Included in delivery: BEF-MU-M08 (1)

Other models and accessories → www.sick.com/IMN

Illustration may differ



Detailed technical data

Features

Housing	Cylindrical thread design
Thread size	M8 x 1
Diameter	Ø 8 mm
Sensing range S_n	1 mm
Safe sensing range S_a	0.81 mm
Installation type	Flush
Switching frequency	2,000 Hz
Connection type	Cable, 2-wire, 2 m
Switching output	NAMUR
Output function	NC
Enclosure rating	IP67 ¹⁾
Special applications	Explosive areas
Items supplied	Mounting nut, brass, nickel-plated (2x)

¹⁾ According to EN 60529.

Mechanics/electronics

Supply voltage	7.5 V DC ... 25 V DC ¹⁾
Hysteresis	1 % ... 15 %
Temperature drift (of S_n)	± 10 %
EMC	According to EN 60947-5-6
Current consumption, sensor is activated	≤ 1 mA

¹⁾ When used outside the hazardous area.

²⁾ For connection to a separately certified intrinsically safe circuit only.

³⁾ 1 kΩ.

Current consumption, sensor is not activated	≥ 2.2 mA
Cable material	PVC
Conductor size	0.14 mm ²
Cable diameter	Ø 3.5 mm
Cable resistance	50 Ω
Shock and vibration resistance	30 g, 11 ms / 10 ... 55 Hz, 1 mm
Ambient operating temperature	-20 °C ... +70 °C
Housing material	Brass, nickel-plated
Sensing face material	Plastic, PTB
Housing length	30 mm
Thread length	29 mm
Tightening torque, max.	≤ 2.5 Nm
Weight	+ 94 g
Type approval certificate	PTB 03 ATEX 2037
Ex area category	1G
Input voltage U_i max.	15 V ²⁾
Input power P_i max.	120 mW ²⁾
Input current I_i max.	50 mA ²⁾
Internal capacitance C_i max.	80 nF ²⁾
Internal inductance L_i max.	70 μH ²⁾
Nominal voltage	8.2 V DC ³⁾
Device labeling	II 1G Ex ia IIC T6 Ga Ta -20 °C ... +70 °C

¹⁾ When used outside the hazardous area.

²⁾ For connection to a separately certified intrinsically safe circuit only.

³⁾ 1 kΩ.

Safety-related parameters

MTTF_D	7,705 years
DC_{avg}	0%
T_M (mission time)	20 years

Reduction factors

Note	The values are reference values which may vary
Stainless steel (V2A, 304)	Approx. 0.7
Aluminum (Al)	Approx. 0.4
Copper (Cu)	Approx. 0.3
Brass (Br)	Approx. 0.5

Installation note

Remark	Associated graphic see "Installation"
B	8 mm
C	8 mm

D	3 mm
F	8 mm

Classifications

eCl@ss 5.0	27270101
eCl@ss 5.1.4	27270101
eCl@ss 6.0	27270101
eCl@ss 6.2	27270101
eCl@ss 7.0	27270101
eCl@ss 8.0	27270101
eCl@ss 8.1	27270101
eCl@ss 9.0	27270101
eCl@ss 10.0	27270101
eCl@ss 11.0	27270101
eCl@ss 12.0	27274001
ETIM 5.0	EC002714
ETIM 6.0	EC002714
ETIM 7.0	EC002714
ETIM 8.0	EC002714
UNSPSC 16.0901	39122230

Installation note

Flush installation

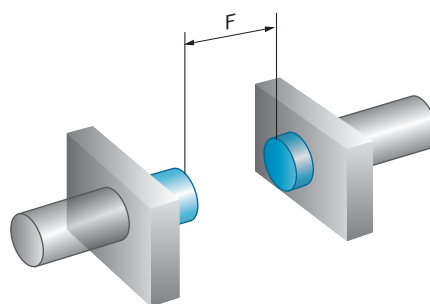
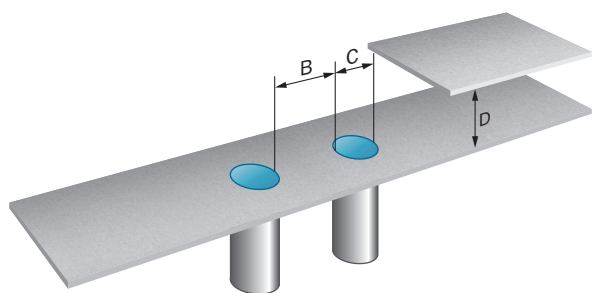

Connection type

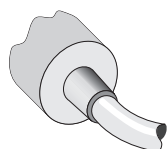

Connection diagram

Cd-012

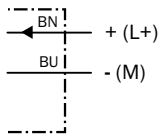

Dimensional drawing (Dimensions in mm (inch))

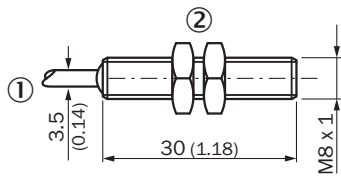

IM08 Namur, flush



- ① Connection
- ② Fastening nuts (2x); width across 13, metal

Recommended accessories

Other models and accessories → www.sick.com/IMN

	Brief description	Type	Part no.
Power supply modules			
	NAMUR isolating amplifier, Cable fault detection, Switching outputs: 2 NO relay (1 per channel), Supply voltage: 24 V ... 230 V, Voltage type: AC/DC	EN2-2EX1	6041096
Mounting brackets and plates			
	Mounting plate for M8 sensors, steel, zinc coated, without mounting hardware	BEF-WG-M08	5321722
	Mounting bracket for M8 sensors, steel, zinc coated, without mounting hardware	BEF-WN-M08	5321721

SICK AT A GLANCE

SICK is one of the leading manufacturers of intelligent sensors and sensor solutions for industrial applications. A unique range of products and services creates the perfect basis for controlling processes securely and efficiently, protecting individuals from accidents and preventing damage to the environment.

We have extensive experience in a wide range of industries and understand their processes and requirements. With intelligent sensors, we can deliver exactly what our customers need. In application centers in Europe, Asia and North America, system solutions are tested and optimized in accordance with customer specifications. All this makes us a reliable supplier and development partner.

Comprehensive services complete our offering: SICK LifeTime Services provide support throughout the machine life cycle and ensure safety and productivity.

For us, that is “Sensor Intelligence.”

WORLDWIDE PRESENCE:

Contacts and other locations –www.sick.com