



# CM18-12NNP-EC1

CM

CAPACITIVE PROXIMITY SENSORS

**SICK**  
Sensor Intelligence.



### Ordering information

Type	Part no.
CM18-12NNP-EC1	6058151

Other models and accessories → [www.sick.com/CM](http://www.sick.com/CM)

Illustration may differ



### Detailed technical data

#### Features

<b>Housing</b>	Cylindrical thread design
<b>Thread size</b>	M18 x 1
<b>Diameter</b>	Ø 18 mm
<b>Sensing range <math>S_n</math></b>	3 mm ... 12 mm
<b>Safe sensing range <math>S_a</math></b>	9.18 mm <sup>1)</sup>
<b>Installation type</b>	Non-flush
<b>Switching frequency</b>	50 Hz
<b>Connection type</b>	Male connector M12, 4-pin
<b>Switching output</b>	NPN
<b>Output function</b>	Complementary
<b>Output characteristic</b>	Wire configurable
<b>Electrical wiring</b>	DC 4-wire
<b>Adjustment</b>	Potentiometer, 11 turns (Sensitivity)
<b>Enclosure rating</b>	IP68 <sup>2)</sup> IP69K
<b>Items supplied</b>	Mounting nut, PA12 plastic (2x) Screwdriver for potentiometer adjustment (1 x)

<sup>1)</sup> For flush mounting in electrically conductive materials  $S_a = 0.8 \times S_r$  at temperatures  $<0 \text{ }^\circ\text{C}$  and  $>60 \text{ }^\circ\text{C}$ .

<sup>2)</sup> 1 m water depth / 60 min.

## Mechanics/electronics

<b>Supply voltage</b>	10 V DC ... 36 V DC
<b>Ripple</b>	≤ 10 % <sup>1)</sup>
<b>Voltage drop</b>	≤ 2.5 V DC <sup>2)</sup>
<b>Current consumption</b>	12 mA <sup>3)</sup>
<b>Time delay before availability</b>	≤ 200 ms
<b>Hysteresis</b>	3 % ... 20 %
<b>Reproducibility</b>	≤ 5 % <sup>4)</sup> <sup>5)</sup>
<b>Temperature drift (of S<sub>r</sub>)</b>	± 10 %
<b>EMC</b>	According to EN 60947-5-2
<b>Continuous current I<sub>a</sub></b>	≤ 200 mA
<b>Short-circuit protection</b>	✓
<b>Reverse polarity protection</b>	✓
<b>Power-up pulse protection</b>	✓
<b>Shock and vibration resistance</b>	According to EN 60068
<b>Ambient operating temperature</b>	-30 °C ... +85 °C <sup>6)</sup>
<b>Ambient temperature, storage</b>	-40 °C ... +85 °C
<b>Housing material</b>	Plastic, PBT
<b>Housing length</b>	85 mm
<b>Thread length</b>	47 mm
<b>Tightening torque, max.</b>	≤ 2.6 Nm
<b>UL File No.</b>	NRKH.E191603

<sup>1)</sup> Of U<sub>b</sub>.

<sup>2)</sup> At I<sub>a</sub> max.

<sup>3)</sup> Without load.

<sup>4)</sup> Of S<sub>r</sub>.

<sup>5)</sup> Supply voltage U<sub>b</sub> and constant ambient temperature T<sub>a</sub>.

<sup>6)</sup> +120 °C short time, at the front of the sensor.

## Safety-related parameters

<b>MTTF<sub>D</sub></b>	919 years
<b>DC<sub>avg</sub></b>	0 %
<b>T<sub>M</sub> (mission time)</b>	20 years

## Reduction factors

<b>Note</b>	The values are reference values which may vary
<b>Metal</b>	1
<b>Water</b>	1
<b>PVC</b>	Approx. 0.4
<b>Oil</b>	Approx. 0.25
<b>Glass</b>	0.6
<b>Ceramics</b>	0.5
<b>Alcohol</b>	0.7

<b>Wood</b>	0.2 ... 0.7
-------------	-------------

Installation note

<b>Remark</b>	Associated graphic see "Installation"
<b>A</b>	18 mm
<b>B</b>	36 mm
<b>C</b>	18 mm
<b>D</b>	36 mm
<b>E</b>	8 mm

Classifications

<b>eCl@ss 5.0</b>	27270102
<b>eCl@ss 5.1.4</b>	27270102
<b>eCl@ss 6.0</b>	27270102
<b>eCl@ss 6.2</b>	27270102
<b>eCl@ss 7.0</b>	27270102
<b>eCl@ss 8.0</b>	27270102
<b>eCl@ss 8.1</b>	27270102
<b>eCl@ss 9.0</b>	27270102
<b>eCl@ss 10.0</b>	27270102
<b>eCl@ss 11.0</b>	27270102
<b>eCl@ss 12.0</b>	27274201
<b>ETIM 5.0</b>	EC002715
<b>ETIM 6.0</b>	EC002715
<b>ETIM 7.0</b>	EC002715
<b>ETIM 8.0</b>	EC002715
<b>UNSPSC 16.0901</b>	39122230

Installation note

Non-flush installation

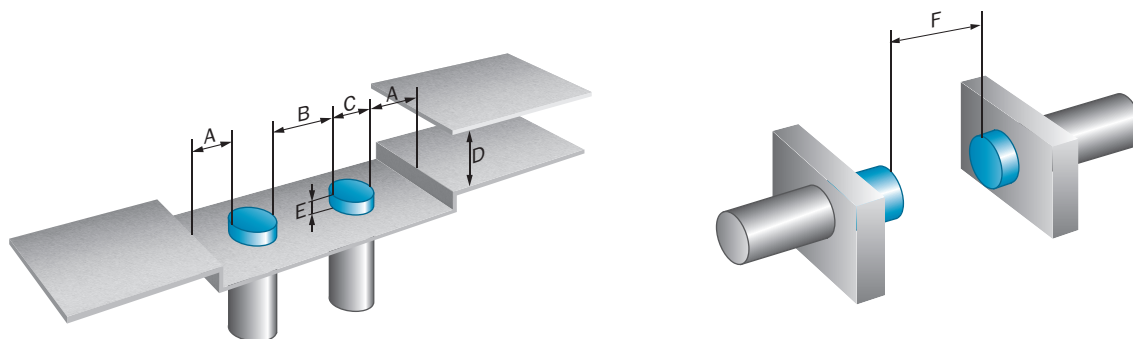

Shock and vibration resistance

Shock (IEC 60068-2-27):	30 G / 11ms, 3 pos, 3 neg per axis
Rough handling shocks (IEC 60068-2-31):	2 times from 1m, 100 times from 0,5m
Vibration (IEC 60068-2-6):	10 to 150 Hz, 1 mm / 15 G

## Electromagnetic compatibility (EMC)

Electrostatic discharge (EN61000-4-2):	Contact discharge > 40 kV Air discharge > 40 kV
Electrical fast transients/burst (EN 61000-4-4):	+/- 4 kV
Surge (EN 61000-4-5):	Power supply > 2 kV (with 500 Ohm) Sensor output > 2 kV (with 500 Ohm)
Wire conducted disturbances (EN 61000-4-6):	> 20 Vrms
Power-frequency magnetic fields (EN 61000-4-8):	Continuous > 60 A/m, 75.9 μ tesla Short-time > 600 A/m, 759 μ tesla
Radiated RF electromagnetic fields (EN 61000-4-3):	> 20 V/m

## Connection diagram

Cd-006

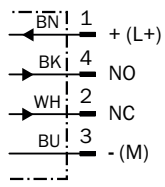

## Response diagram

CM18, Non-flush installation

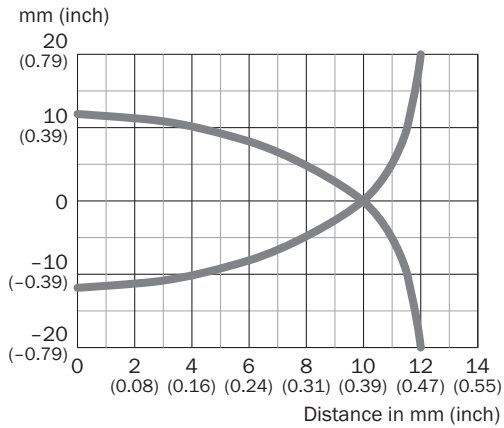

**Dimensional drawing** (Dimensions in mm (inch))

CM18, non-flush, connector

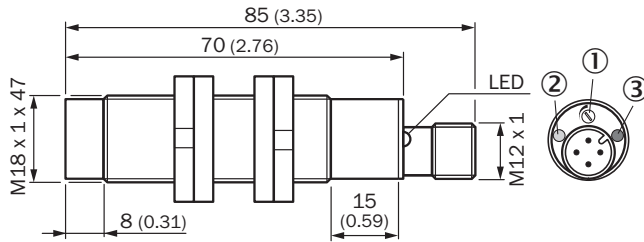







- ① Potentiometer for sensitivity adjustment
- ② LED yellow: status indicator
- ③ LED green: operating indicator

**Recommended accessories**

Other models and accessories → [www.sick.com/CM](http://www.sick.com/CM)

	<b>Brief description</b>	<b>Type</b>	<b>Part no.</b>
<b>Universal bar clamp systems</b>			
	Plate N06 for universal clamp bracket, M18, Zinc plated steel (sheet), Zinc die cast (clamping bracket), Universal clamp (5322626), mounting hardware	BEF-KHS-N06	2051612
	Plate N06N for universal clamp bracket, M18, Stainless steel 1.4571 (sheet), Stainless steel 1.4408 (clamp), Universal clamp (5322627), mounting hardware	BEF-KHS-N06N	2051622
<b>Mounting brackets and plates</b>			
	Mounting plate for M18 sensors, steel, zinc coated, without mounting hardware	BEF-WG-M18	5321870
	Mounting bracket for M18 sensors, steel, zinc coated, without mounting hardware	BEF-WN-M18	5308446
<b>Plug connectors and cables</b>			
	Head A: female connector, M12, 4-pin, straight, A-coded Head B: Flying leads Cable: Sensor/actuator cable, PUR, halogen-free, unshielded, 2 m	YF2A14-020UB3XLEAX	2095607
	Head A: female connector, M12, 4-pin, straight, A-coded Head B: Flying leads Cable: Sensor/actuator cable, PVC, unshielded, 2 m	YF2A14-020VB3XLEAX	2096234
	Head A: female connector, M12, 4-pin, straight, A-coded Head B: Flying leads Cable: Sensor/actuator cable, PUR, halogen-free, unshielded, 5 m	YF2A14-050UB3XLEAX	2095608
	Head A: female connector, M12, 4-pin, straight, A-coded Head B: Flying leads Cable: Sensor/actuator cable, PVC, unshielded, 5 m	YF2A14-050VB3XLEAX	2096235
	Head A: female connector, M12, 4-pin, angled, A-coded Head B: Flying leads Cable: Sensor/actuator cable, PUR, halogen-free, unshielded, 2 m	YG2A14-020UB3XLEAX	2095766

	<b>Brief description</b>	<b>Type</b>	<b>Part no.</b>
	Head A: female connector, M12, 4-pin, angled, A-coded Head B: Flying leads Cable: Sensor/actuator cable, PVC, unshielded, 2 m	YG2A14-020VB3XLEAX	2095895
	Head A: female connector, M12, 4-pin, angled, A-coded Head B: Flying leads Cable: Sensor/actuator cable, PUR, halogen-free, unshielded, 5 m	YG2A14-050UB3XLEAX	2095767
	Head A: female connector, M12, 4-pin, angled, A-coded Head B: Flying leads Cable: Sensor/actuator cable, PVC, unshielded, 5 m	YG2A14-050VB3XLEAX	2095897
	Head A: female connector, M12, 4-pin, straight Cable: unshielded	DOS-1204-G	6007302
	Head A: female connector, M12, 4-pin, angled Cable: unshielded	DOS-1204-W	6007303
<b>Terminal and alignment brackets</b>			
	Clamping block for round sensors M18, without fixed stop, plastic (PA12), glass-fiber reinforced, mounting hardware included	BEF-KH-M18	2051481
	Clamping block for round sensors M18, with fixed stop, plastic (PA12), glass-fiber reinforced, mounting hardware included	BEF-KHF-M18	2051482

## SICK AT A GLANCE

SICK is one of the leading manufacturers of intelligent sensors and sensor solutions for industrial applications. A unique range of products and services creates the perfect basis for controlling processes securely and efficiently, protecting individuals from accidents and preventing damage to the environment.

We have extensive experience in a wide range of industries and understand their processes and requirements. With intelligent sensors, we can deliver exactly what our customers need. In application centers in Europe, Asia and North America, system solutions are tested and optimized in accordance with customer specifications. All this makes us a reliable supplier and development partner.

Comprehensive services complete our offering: SICK LifeTime Services provide support throughout the machine life cycle and ensure safety and productivity.

For us, that is “Sensor Intelligence.”

## WORLDWIDE PRESENCE:

Contacts and other locations –[www.sick.com](http://www.sick.com)