



DL35-B15552

Dx35

MID RANGE DISTANCE SENSORS

SICK
Sensor Intelligence.



Ordering information

Type	Part no.
DL35-B15552	1057657

Other models and accessories → www.sick.com/Dx35



Detailed technical data

Mechanics/electronics

Supply voltage V_s	DC 12 V ... 30 V ^{1) 2)}
Ripple	$\leq 5 V_{pp}$ ³⁾
Power consumption	$\leq 1.7 W$ ⁴⁾
Initialization time	≤ 500 ms
Warm-up time	≤ 20 min
Housing material	Plastic (ABS/PC)
Window material	Plastic (PMMA)
Connection type	Male connector, M12, 5-pin
Indication	LEDs
Weight	65 g
Dimensions (W x H x D)	32 mm x 58.67 mm x 42.7 mm
Enclosure rating	IP65 IP67
Protection class	III

¹⁾ Limit values, reverse-polarity protected, operation in short-circuit protected network: max. 8 A.

²⁾ When using IO-Link output $V_s > 18$ V. When using analog voltage output $V_s > 13$ V.

³⁾ May not fall short of or exceed V_s tolerances.

⁴⁾ Without load, at +20 °C.

Safety-related parameters

MTTF_D	101 years
-------------------------	-----------

Performance

Measurement range min ... max:	200 mm ... 35,000 mm, on "diamond grade" reflective tape ¹⁾
Target	Reflector
Resolution	0.1 mm
Repeatability	≥ 0.5 mm ^{1) 2)}
Accuracy	Typ. ± 15 mm ³⁾
Response time	2.5 ms ... 96.5 ms, 2.5 ms / 6.5 ms / 12.5 ms / 24.5 ms / 96.5 ms ^{4) 5)}
Switching frequency	333 Hz / 100 Hz / 50 Hz / 25 Hz / 6 Hz ^{4) 5)}
Output time	1 ms ... 32 ms, 1 ms/2 ms/4 ms/8 ms/32 ms ^{4) 6)}
Light source	Laser, red ⁷⁾ visible red light
Laser class	1 (IEC 60825-1:2014, EN 60825-1:2014)
Typ. light spot size (distance)	15 mm x 15 mm (at 2 m)
Additional function	Set speed: Super Fast ... Super Slow, teach-in of analog output and invertible analog output, Output Q ₂ adaptable: Current output / Voltage output / Digital output, Switching mode: Distance to reflective tape (DtR) / switching window (Wnd) / object between sensor and background (ObSB), teach-in of digital output and digital output invertible, Multifunctional input: laser off / external teach / deactivated, reset to factory default
Average laser service life (at 25 °C)	100,000 h

¹⁾ See repeatability characteristic lines.

²⁾ Equivalent to 1 σ .

³⁾ On "diamond grade" reflective tape.

⁴⁾ Depending on the set speed: Super Fast ... Super Slow.

⁵⁾ Lateral entry of the object into the measuring range.

⁶⁾ Continuous change of distance in measuring range.

⁷⁾ Wavelength: 658 nm; max. output: 120 mW; pulse duration: 3 ns; duty cycle: 1/250.

Interfaces

IO-Link	✓, IO-Link V1.1
Function	Process data, parameterization, diagnosis
Data transmission rate	38.4 kbit/s
Digital output	
Number	1 ... 2 ^{1) 2)}
Type	Push-pull: PNP/NPN
Function	Output Q ₂ adaptable: Current output / Voltage output / Digital output / Q ₁ not / deactivated
Maximum output current I _A	≤ 100 mA
Analog output	
Number	1
Type	Current output / voltage output
Function	Output Q ₂ adaptable: Current output / Voltage output / Digital output
Current	4 mA ... 20 mA, ≤ 450 Ω
Voltage	0 V ... 10 V, ≥ 50,000 Ω

¹⁾ Output Q short-circuit protected.

²⁾ Voltage drop < 3 V.

³⁾ Response time ≤ 60 ms.

⁴⁾ Configurable via IO-Link.

	Resolution	12 bit
Multifunctional input (MF)		1 x ³⁾
Hysteresis		0 mm ... 34,950 mm ⁴⁾

¹⁾ Output Q short-circuit protected.

²⁾ Voltage drop < 3 V.

³⁾ Response time ≤ 60 ms.

⁴⁾ Configurable via IO-Link.

Ambient data

Ambient temperature, operation	-30 °C ... +55 °C, U _v ≤ 24 V
Ambient temperature, storage	-40 °C ... +75 °C
Max. rel. humidity (not condensing)	≤ 95 %
Vibration resistance	EN 60068-2-6, EN 60068-2-64
Shock resistance	EN 60068-2-27

Classifications

ECLASS 5.0	27270801
ECLASS 5.1.4	27270801
ECLASS 6.0	27270801
ECLASS 6.2	27270801
ECLASS 7.0	27270801
ECLASS 8.0	27270801
ECLASS 8.1	27270801
ECLASS 9.0	27270801
ECLASS 10.0	27270801
ECLASS 11.0	27270801
ECLASS 12.0	27270916
ETIM 5.0	EC001825
ETIM 6.0	EC001825
ETIM 7.0	EC001825
ETIM 8.0	EC001825
UNSPSC 16.0901	41111613

Dimensional drawing (Dimensions in mm (inch))

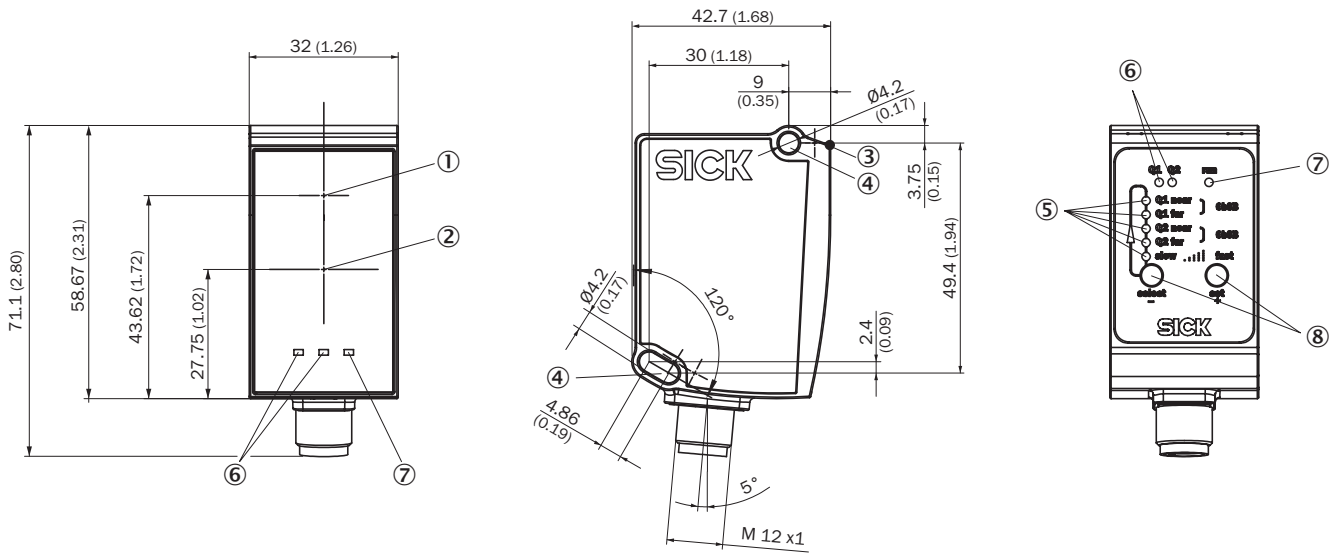

- ① Optical axis, sender
- ② Optical axis, receiver
- ③ Zero level
- ④ Mounting hole M4
- ⑤ Status indicator output Q_A/Q₂
- ⑥ Status LEDs output Q₁
- ⑦ Operating indicator
- ⑧ Control elements

Connection type

Male connector M12, 5-pin

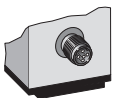

Connection diagram

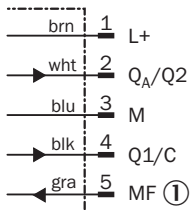

① Multifunctional input (MF)

Repeatability

Characteristic curve 1) Super Slow ... 5) Super Fast



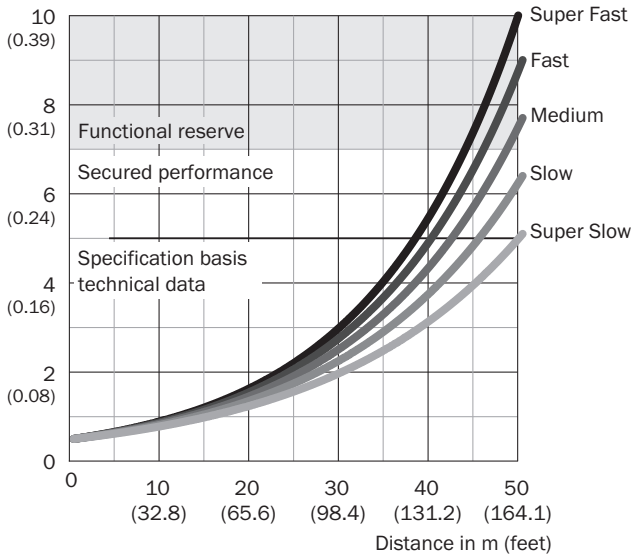

Super Slow ... Super Fast

Repeatability in mm (inch)







Recommended accessories

Other models and accessories → www.sick.com/Dx35

	Brief description	Type	Part no.
Universal bar clamp systems			
	Plate N02 for universal clamp bracket, Zinc plated steel (sheet), Zinc die cast (clamping bracket), Universal clamp (5322626), mounting hardware	BEF-KHS-N02	2051608
Mounting brackets and plates			
	Mounting bracket: horizontal sending axis for ceiling or floor installation or vertical sending axis for wall installation, steel, zinc coated, incl. mounting material, steel, zinc coated, mounting hardware for the sensor included	BEF-WN-DX35	2069592
Plug connectors and cables			
	Head A: female connector, M12, 5-pin, straight, A-coded Head B: Flying leads Cable: Sensor/actuator cable, PVC, unshielded, 2 m	YF2A15-020VB5XLEAX	2096239
	Head A: female connector, M12, 5-pin, angled, A-coded Head B: Flying leads Cable: Sensor/actuator cable, PVC, unshielded, 2 m	YG2A15-020VB5XLEAX	2096215

¹⁾ Customizable length by sheet. Width max. 74.9 cm, length max. 91.4 cm.

	Brief description	Type	Part no.
	Head A: female connector, M12, 5-pin, straight, A-coded Head B: male connector, M12, 5-pin, straight, A-coded Cable: Sensor/actuator cable, PUR, halogen-free, unshielded, 2 m	YF2A15-020UB5M2A15	2096009
Reflectors			
	Reflector plate, "diamond grade" reflective tape, 330 mm x 330 mm, base plate material: aluminum, screw connection, Screw-on, 4 hole mounting	PL240DG	1017910
	"Diamond grade" reflective tape, self-adhesive, can be assembled from the sheet, 74.9 cm x 91.4 cm ¹⁾ , self-adhesive	REF-DG-K	4019634
Terminal and alignment brackets			
	Alignment unit, steel, zinc coated, mounting hardware for the sensor included	BEF-AH-DX50	2048397

¹⁾ Customizable length by sheet. Width max. 74.9 cm, length max. 91.4 cm.

SICK AT A GLANCE

SICK is one of the leading manufacturers of intelligent sensors and sensor solutions for industrial applications. A unique range of products and services creates the perfect basis for controlling processes securely and efficiently, protecting individuals from accidents and preventing damage to the environment.

We have extensive experience in a wide range of industries and understand their processes and requirements. With intelligent sensors, we can deliver exactly what our customers need. In application centers in Europe, Asia and North America, system solutions are tested and optimized in accordance with customer specifications. All this makes us a reliable supplier and development partner.

Comprehensive services complete our offering: SICK LifeTime Services provide support throughout the machine life cycle and ensure safety and productivity.

For us, that is “Sensor Intelligence.”

WORLDWIDE PRESENCE:

Contacts and other locations –www.sick.com