



DL100-21AA2212

Dx100

LONG RANGE DISTANCE SENSORS

SICK
Sensor Intelligence.



Illustration may differ



Ordering information

| Type | Part no. |
|----------------|----------|
| DL100-21AA2212 | 1086984 |

Other models and accessories → www.sick.com/Dx100

Detailed technical data

Mechanics/electronics

| | |
|--|--|
| Supply voltage V_s | DC 18 V ... 30 V, limit values |
| Ripple | 5 V _{pp} ¹⁾ |
| Initialization time | Typ. 1.5 s ²⁾ |
| Housing material | Metal (Aluminum die cast) |
| Window material | Plastic (PMMA) |
| Connection type | Male connector, M12, SPEEDCON™ compatible |
| Indication | 6 digit 5 x 7 dot matrix display, LEDs |
| Weight | Approx. 800 g (with mounting bracket: approx. 1,600 g) |
| Current consumption | At 24 V DC < 250 mA |
| Dimensions (W x H x D) | 69.4 mm x 82.5 mm x 100.2 mm |
| Modulation frequency | Fix |
| Enclosure rating | IP65 |
| Protection class | III |

¹⁾ May not fall short of or exceed V_s tolerances.

²⁾ After loss of reflector < 40 ms.

Safety-related parameters

| | |
|-------------------------|-----------|
| MTTF_D | 101 years |
| DC_{avg} | 0% |

Performance

| | |
|---------------------------------------|--|
| Measurement range min ... max: | 0.15 m ... 100 m, on "diamond grade" reflective tape |
| Target | Reflector |
| Resolution | 0.1 mm, 0.125 mm, 1 mm, 10 mm, 100 mm, freely adjustable |
| Repeatability | 0.5 mm ¹⁾ |

¹⁾ Statistical error 1 σ , environmental conditions constant, min. warm-up time 10 min.

²⁾ From 150 mm ... 180 mm measuring range the accuracy can reach ± 4 mm.

³⁾ Average service life: 100,000 h at $T_U = +25$ °C.

| | |
|--|--|
| Accuracy | $\pm 2 \text{ mm}^2)$ |
| Response time | 2 ms |
| Measurement cycle time | 1 ms |
| Output time | 1 ms |
| Light source | Laser, red ³⁾ visible red light |
| Laser class | 2, complies with 21 CFR 1040.10 and 1040.11 except for the conformance according to "Laser Notice No. 50" from June 24, 2007 (IEC 60825-1:2014, EN 60825-1:2014) |
| Typ. light spot size (distance) | 5 mm + (2 mm x distance in m) |
| Max. movement speed | 15 m/s |
| Acceleration (max.) | $\leq 15 \text{ m/s}^2$ |

¹⁾ Statistical error 1σ , environmental conditions constant, min. warm-up time 10 min.

²⁾ From 150 mm ... 180 mm measuring range the accuracy can reach $\pm 4 \text{ mm}$.

³⁾ Average service life: 100,000 h at $T_U = +25 \text{ }^\circ\text{C}$.

Interfaces

| | |
|-----------------------------------|---|
| PROFINET | ✓ |
| Network load class | III |
| Digital output | |
| Number | 2 ¹⁾ |
| Type | Push-pull: PNP/NPN |
| Function | Distance: Distance switching output Speed; Speed output Service: Warning message as the sensor ages, if the damping value is exceeded (for example when contaminated, if the permitted interior device temperature is exceeded or undercut, if the measured value has a plausibility error, if the laser is not ready for operation, if the heating is switched on Laser off Preset |
| Maximum output current I_A | $\leq 100 \text{ mA}^2)$ |
| Multifunctional input (MF) | 1 x MF1 ³⁾ |

¹⁾ HIGH = $> V_S - 3 \text{ V}$ / LOW = $< 2 \text{ V}$.

²⁾ Max. 100 nF/20 mA.

³⁾ HIGH $> 12 \text{ V}$ / LOW $< 3 \text{ V}$.

Ambient data

| | |
|--|---|
| Electromagnetic compatibility (EMC) | EN 61000-6-2, EN 61000-6-4 ¹⁾ |
| Ambient temperature, operation | $-20 \text{ }^\circ\text{C} \dots +55 \text{ }^\circ\text{C}^2)$ $-20 \text{ }^\circ\text{C} \dots +75 \text{ }^\circ\text{C}$, operation with cooling case ²⁾ |
| Ambient temperature, storage | $-40 \text{ }^\circ\text{C} \dots +75 \text{ }^\circ\text{C}$ |
| Effect of air pressure | 0.3 ppm/hPa |
| Effect of air temperature | 1 ppm/K |
| Temperature drift | Typ. 0.1 mm/K |
| Typ. Ambient light immunity | $\leq 100,000 \text{ lx}$ |
| Mechanical load | Shock: (EN 600 68-2-27) |

¹⁾ This is a Class A device. This device can cause radio interference in living quarters.

²⁾ Temperatures $< -10 \text{ }^\circ\text{C}$ require warm-up time of typ. 7 minutes.

Sine: (EN 600 68-2-6)
Noise: (EN 600 68-2-64)

¹⁾ This is a Class A device. This device can cause radio interference in living quarters.

²⁾ Temperatures < -10 °C require warm-up time of typ. 7 minutes.

Classifications

| | |
|-----------------------|----------|
| ECLASS 5.0 | 27270801 |
| ECLASS 5.1.4 | 27270801 |
| ECLASS 6.0 | 27270801 |
| ECLASS 6.2 | 27270801 |
| ECLASS 7.0 | 27270801 |
| ECLASS 8.0 | 27270801 |
| ECLASS 8.1 | 27270801 |
| ECLASS 9.0 | 27270801 |
| ECLASS 10.0 | 27270801 |
| ECLASS 11.0 | 27270801 |
| ECLASS 12.0 | 27270916 |
| ETIM 5.0 | EC001825 |
| ETIM 6.0 | EC001825 |
| ETIM 7.0 | EC001825 |
| ETIM 8.0 | EC001825 |
| UNSPSC 16.0901 | 41111613 |

Dimensional drawing (Dimensions in mm (inch))

Dimensional drawing

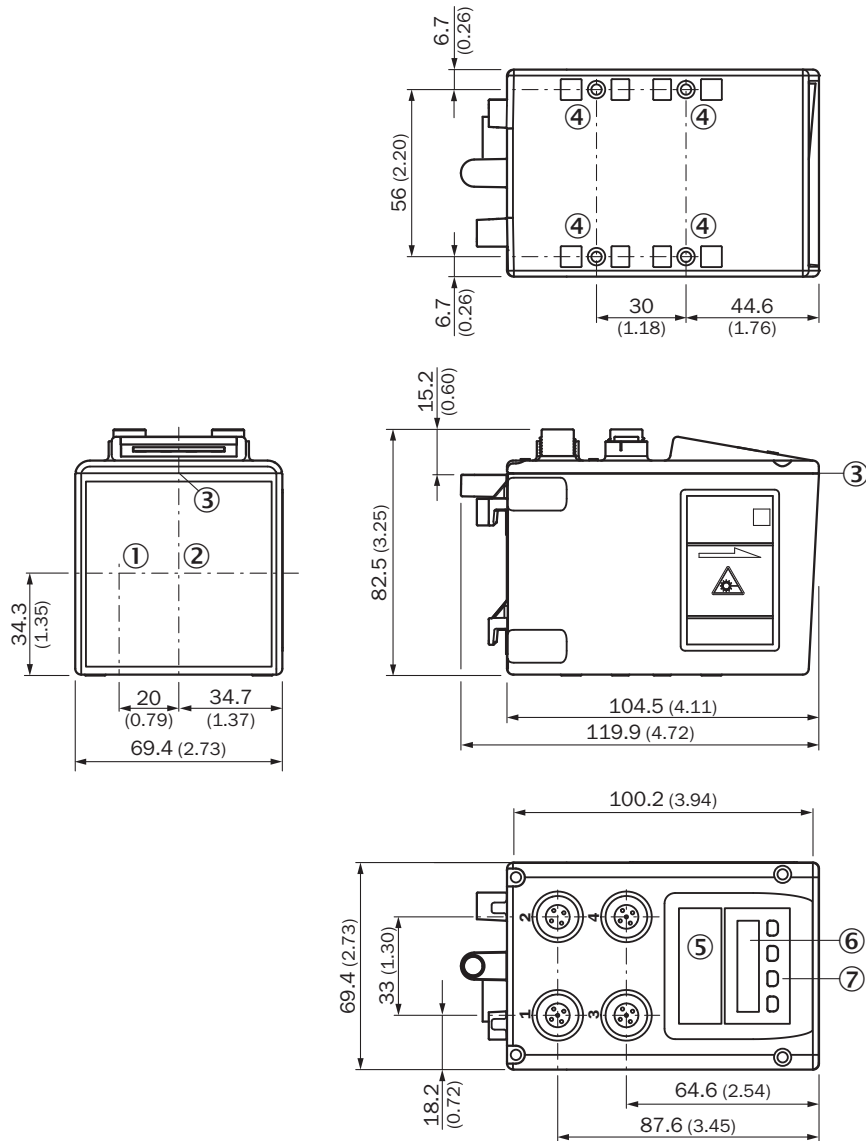

- ① Optical axis, sender
- ② Optical axis, receiver
- ③ Zero level
- ④ Threaded mounting hole M5
- ⑤ Status LED [status]
- ⑥ Display
- ⑦ Control elements

Connection type

Ethernet connection type

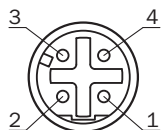

Voltage supply connection type

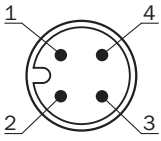

PROFINET port 1, port 2 connection type

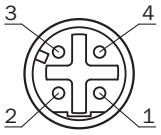

Connection diagram

Voltage supply connection diagram

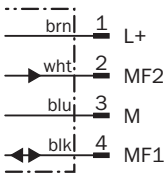

Ethernet connection diagram

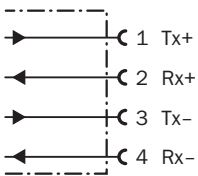

Adjustment possible



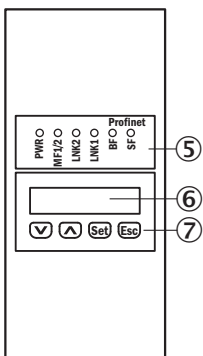

DL100-xxxxxx12



- ⑤ Status LED [status]
- ⑥ Display
- ⑦ Control elements

Recommended accessories

Other models and accessories → www.sick.com/Dx100

| | Brief description | Type | Part no. |
|--|---|--------------------|----------|
| Plug connectors and cables | | | |
|  | <ul style="list-style-type: none"> • Connection type head A: Female connector, M12, 4-pin, straight, A-coded • Connection type head B: Flying leads • Signal type: Sensor/actuator cable • Cable: 5 m, 4-wire, PVC • Description: Sensor/actuator cable, unshielded • Application: Zones with chemicals | YF2A14-050VB3XLEAX | 2096235 |
|  | <ul style="list-style-type: none"> • Connection type head A: Male connector, M12, 4-pin, straight, D-coded • Connection type head B: Flying leads • Signal type: Ethernet, PROFINET • Cable: 5 m, 4-wire, PUR, halogen-free • Description: Ethernet, shieldedPROFINET • Application: Drag chain operation, Zones with oils and lubricants | YM2D24-050PN1XLEAX | 2106172 |
| Reflectors | | | |
|  | Reflector plate, "diamond grade" reflective tape, 330 mm x 330 mm, base plate material: aluminum, screw connection, Screw-on, 4 hole mounting | PL240DG | 1017910 |
|  | Reflector plate, "diamond grade" reflective tape, 665 mm x 665 mm, base plate material: aluminum, screw connection, Screw-on, 4 hole mounting | PL560DG | 1016806 |
| Terminal and alignment brackets | | | |
|  | Alignment unit for Dx100, incl. mounting material, steel, zinc coated | BEF-AH-DX100 | 2058653 |

SICK AT A GLANCE

SICK is one of the leading manufacturers of intelligent sensors and sensor solutions for industrial applications. A unique range of products and services creates the perfect basis for controlling processes securely and efficiently, protecting individuals from accidents and preventing damage to the environment.

We have extensive experience in a wide range of industries and understand their processes and requirements. With intelligent sensors, we can deliver exactly what our customers need. In application centers in Europe, Asia and North America, system solutions are tested and optimized in accordance with customer specifications. All this makes us a reliable supplier and development partner.

Comprehensive services complete our offering: SICK LifeTime Services provide support throughout the machine life cycle and ensure safety and productivity.

For us, that is “Sensor Intelligence.”

WORLDWIDE PRESENCE:

Contacts and other locations –www.sick.com