



WTB26I-24G11420ZZZ

W26

COMPACT PHOTOELECTRIC SENSORS

SICK
Sensor Intelligence.



Illustration may differ



Ordering information

Type	Part no.
WTB26I-24G11420ZZZ	1124859

Other models and accessories → www.sick.com/W26

Detailed technical data

Features

Functional principle	Photoelectric proximity sensor
Functional principle detail	Background suppression
Sensing range	
Sensing range min.	30 mm
Sensing range max.	3,000 mm
Adjustable switching threshold for background suppression	180 mm ... 3,000 mm
Reference object	Object with 90% remission factor (complies with standard white according to DIN 5033)
Minimum distance between set sensing range and background (black 6% / white 90%)	190 mm, at a distance of 1000 mm
Recommended sensing range for the best performance	200 mm ... 1,000 mm
Emitted beam	
Light source	LED
Type of light	Infrared light
Shape of light spot	Point-shaped
Light spot size (distance)	Ø 12 mm (800 mm)
Maximum dispersion of the emitted beam around the standardized transmission axis (squint angle)	< +/- 1.0° (at Ta = +23 °C)
Key LED figures	
Normative reference	EN 62471:2008-09 IEC 62471:2006, modified
LED risk group marking	Free group

Wave length	850 nm
Average service life	100,000 h at $T_a = +25 \text{ }^\circ\text{C}$
Adjustment	
Teach-Turn adjustment	BluePilot: For setting the sensing range
Indication	
LED blue	BluePilot: sensing range indicator
LED green	Operating indicator Static on: power on
LED yellow	Status of received light beam Static on: object present Static off: object not present

Safety-related parameters

MTTF_D	626 years
DC_{avg}	0%
T_M (mission time)	20 years (EN ISO 13849, rate of use: 60 %)

Electrical data

Supply voltage U_B	10 V DC ... 30 V DC ¹⁾
Ripple	$\leq 5 \text{ V}_{pp}$
Usage category	DC-12 (According to EN 60947-5-2) DC-13 (According to EN 60947-5-2)
Current consumption	$\leq 30 \text{ mA}$, without load. At $U_B = 24 \text{ V}$ ²⁾
Protection class	III
Digital output	
Number	2 (Complementary)
Type	NPN
Signal voltage NPN HIGH/LOW	Approx. $U_B / < 2.5 \text{ V}$
Output current I _{max}	$\leq 100 \text{ mA}$
Circuit protection outputs	Reverse polarity protected Overcurrent and short-circuit protected
Response time	$\leq 2.5 \text{ ms}$ ³⁾
Repeatability (response time)	150 μs
Switching frequency	200 Hz ⁴⁾
Pin/Wire assignment	
Function of pin 4/black (BK)	Digital output, light switching, object present → output Q HIGH
Function of pin 2/white (WH)	Digital output, dark switching, object present → output \bar{Q} LOW

¹⁾ Limit values.

²⁾ 10 V DC ... 16 V DC, without load.

³⁾ Signal transit time with resistive load in switching mode.

⁴⁾ With light/dark ratio 1:1.

Mechanical data

Housing	Rectangular
Dimensions (W x H x D)	20 mm x 55.7 mm x 42 mm
Connection	Male connector M12, 4-pin

Material	Housing	Plastic, VISTAL®
	Front screen	Plastic, PMMA
	Male connector	Plastic, VISTAL®
Weight	Approx. 80 g	
Maximum tightening torque of the fixing screws	1.3 Nm	

Ambient data

Enclosure rating	IP66 (EN 60529) IP67 (EN 60529) IP69 (EN 60529) ¹⁾
Ambient operating temperature	-40 °C ... +60 °C
Ambient temperature, storage	-40 °C ... +75 °C
Shock resistance	50 g, 11 ms (25 positive and 25 negative shocks per axis, for X, Y, Z axes, 150 shocks in total (EN60068-2-27)) 50 g, 6 ms (5,000 positive and 5,000 negative shocks per axis, for X, Y, Z axes, 30,000 shocks in total (EN60068-2-27))
Vibration resistance	10 Hz ... 2,000 Hz (Amplitude 0.5 mm / 10 g, 20 sweeps per axis, for X, Y, Z axes, 1 octave/min, (EN60068-2-6))
Air humidity	35 % ... 95 %, Relative humidity (no condensation)
Electromagnetic compatibility (EMC)	EN 60947-5-2
Resistance to cleaning agent	ECOLAB
UL File No.	NRKH.E181493 & NRKH7.E181493

¹⁾ Replaces IP69K with ISO 20653: 2013-03.

Classifications

ECLASS 5.0	27270904
ECLASS 5.1.4	27270904
ECLASS 6.0	27270904
ECLASS 6.2	27270904
ECLASS 7.0	27270904
ECLASS 8.0	27270904
ECLASS 8.1	27270904
ECLASS 9.0	27270904
ECLASS 10.0	27270904
ECLASS 11.0	27270904
ECLASS 12.0	27270903
ETIM 5.0	EC002719
ETIM 6.0	EC002719
ETIM 7.0	EC002719
ETIM 8.0	EC002719
UNSPSC 16.0901	39121528

Dimensional drawing (Dimensions in mm (inch))

Dimensional drawing, sensor

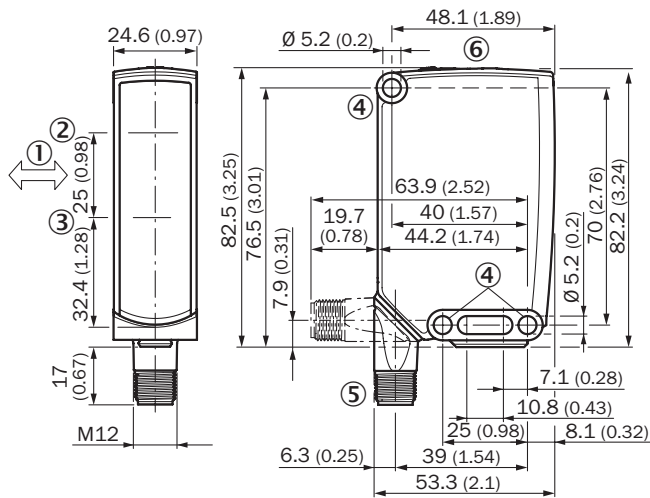

- ① Standard direction of the material being detected
- ② Center of optical axis, sender
- ③ Center of optical axis, receiver
- ④ Mounting hole, \varnothing 5.2 mm
- ⑤ Connection
- ⑥ Display and adjustment elements

Adjustments

Display and adjustment elements

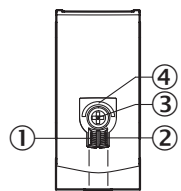

- ① LED indicator green
- ② LED indicator yellow
- ③ Teach-Turn adjustment
- ④ LED blue

Connection type

M12 male connector, 4-pin

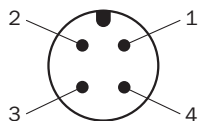

Connection diagram

Cd-414

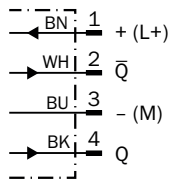

Truth table

NPN - dark switching \bar{Q}

	Dark switching \bar{Q} (normally closed)	
	Object not present → Output LOW	Object present → Output HIGH
Light receive	✗	✓
Light receive indicator	✗	☀️
Load resistance to L+	⚠️	✗

NPN - light switching Q

	Light switching Q (normally open)	
	Object not present → Output HIGH	Object present → Output LOW
Light receive	✗	✓
Light receive indicator	✗	☀️
Load resistance to L+	✗	⚠️

Characteristic curve

Minimum distance in mm (y) between the set sensing range and white background (90 % remission)

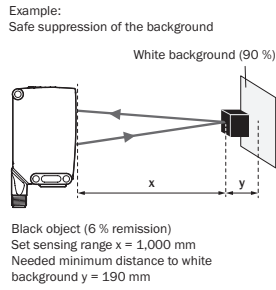
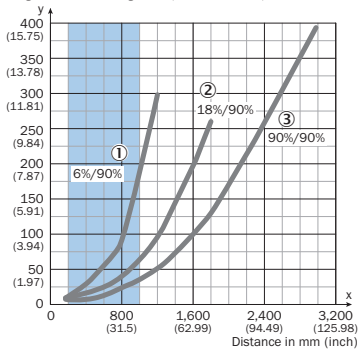

Recommended sensing range for the best performance

- ① Black object, 6% remission factor
- ② Gray object, 18% remission factor
- ③ White object, 90% remission factor

Light spot size

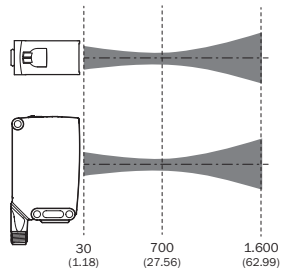
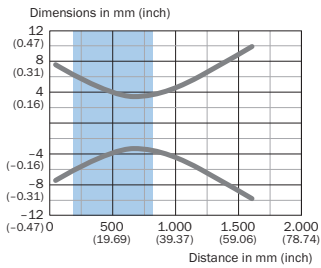

Recommended sensing range for the best performance

Sensing range diagram

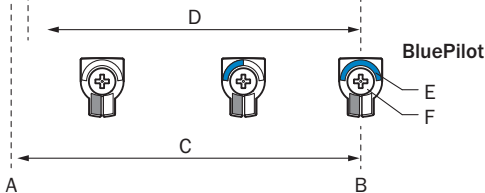
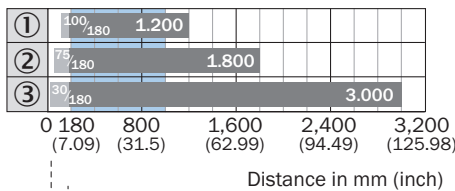



Recommended sensing range for the best performance

1	Black object, 6% remission factor
---	-----------------------------------

2	Gray object, 18% remission factor
3	White object, 90% remission factor
A	Sensing range min. in mm
B	Sensing range max. in mm
C	Field of view
D	Adjustable switching threshold for background suppression
E	Sensing range indicator
F	Teach-Turn adjustment

Recommended accessories

Other models and accessories → www.sick.com/W26

	Brief description	Type	Part no.
Universal bar clamp systems			
	Plate N12 for universal clamp. For mounting PL30A, P250 reflectors, W27 and WTR2 sensors., Zinc plated steel (sheet), Zinc die cast (clamping bracket), Universal clamp (2022726), mounting hardware	BEF-KHS-N12	2071950
Plug connectors and cables			
	Head A: female connector, M12, 4-pin, straight, A-coded Head B: Flying leads Cable: Sensor/actuator cable, PVC, unshielded, 5 m	YF2A14-050VB3XLEAX	2096235
	Head A: male connector, M12, 4-pin, straight Cable: unshielded	STE-1204-G	6009932

SICK AT A GLANCE

SICK is one of the leading manufacturers of intelligent sensors and sensor solutions for industrial applications. A unique range of products and services creates the perfect basis for controlling processes securely and efficiently, protecting individuals from accidents and preventing damage to the environment.

We have extensive experience in a wide range of industries and understand their processes and requirements. With intelligent sensors, we can deliver exactly what our customers need. In application centers in Europe, Asia and North America, system solutions are tested and optimized in accordance with customer specifications. All this makes us a reliable supplier and development partner.

Comprehensive services complete our offering: SICK LifeTime Services provide support throughout the machine life cycle and ensure safety and productivity.

For us, that is “Sensor Intelligence.”

WORLDWIDE PRESENCE:

Contacts and other locations –www.sick.com