



# WTT4SLC-3B0062B03

PowerProx

MULTITASK PHOTOELECTRIC SENSORS

**SICK**  
Sensor Intelligence.



Illustration may differ



### Ordering information

Type	Part no.
WTT4SLC-3B0062B03	1118144

Other models and accessories → [www.sick.com/PowerProx](http://www.sick.com/PowerProx)

### Detailed technical data

#### Features

<b>Functional principle</b>	Photoelectric proximity sensor
<b>Functional principle detail</b>	Background suppression, Optical time-of-flight
<b>Dimensions (W x H x D)</b>	12.2 mm x 41.8 mm x 17.3 mm
<b>Housing design (light emission)</b>	Rectangular
<b>Sensing range max.</b>	50 mm ... 1,300 mm <sup>1)</sup>
<b>Sensing range</b>	100 mm ... 1,300 mm <sup>2)</sup>
<b>Distance value</b>	
Measuring range	90 mm ... 1,300 mm <sup>1)</sup>
Resolution	1 mm
Repeatability	4,5 mm ... 11 mm <sup>3) 4) 5)</sup>
Accuracy	- 10 mm, + 80 mm
Distance value output	Via IO-Link
Update rate of the distance value	0.8 ms
<b>Type of light</b>	Visible red light
<b>Light source</b>	Laser <sup>6)</sup>
<b>Light spot size (distance)</b>	Ø 4 mm (1,000 mm)
<b>Wave length</b>	658 nm

<sup>1)</sup> Object with 6 ... 90% remission (based on standard white, DIN 5033).

<sup>2)</sup> Adjustable.

<sup>3)</sup> Equivalent to 1  $\sigma$ .

<sup>4)</sup> See characteristic curves repeatability.

<sup>5)</sup> 6% ... 90% remission factor.

<sup>6)</sup> Average service life: 50,000 h at  $T_U = +25 \text{ }^\circ\text{C}$ .

<b>Laser class</b>	1 (IEC 60825-1 / CDRH 21 CFR 1040.10 & 1040.11)
<b>Adjustment</b>	Single teach-in button IO-Link
<b>Pin 2 configuration</b>	External input, Teach-in input, Sender off input, Detection output, logic output

<sup>1)</sup> Object with 6 ... 90% remission (based on standard white, DIN 5033).

<sup>2)</sup> Adjustable.

<sup>3)</sup> Equivalent to 1  $\sigma$ .

<sup>4)</sup> See characteristic curves repeatability.

<sup>5)</sup> 6% ... 90% remission factor.

<sup>6)</sup> Average service life: 50,000 h at  $T_U = +25 \text{ }^\circ\text{C}$ .

## Mechanics/electronics

<b>Supply voltage <math>U_B</math></b>	10 V DC ... 30 V DC <sup>1)</sup>
<b>Ripple</b>	< 5 V <sub>pp</sub> <sup>2)</sup>
<b>Current consumption</b>	25 mA <sup>3)</sup>
<b>Switching output</b>	Push-pull: PNP/NPN
<b>Output function</b>	Factory setting: Pin 2 / white (MF): NPN normally open (light switching), PNP normally closed (dark switching), Pin 4 / black (QL1 / C): NPN normally closed (dark switching), PNP normally open (light switching), IO-Link
<b>Switching mode</b>	Dark/light switching
<b>Output current <math>I_{\max}</math></b>	≤ 50 mA
<b>Response time</b>	≤ 5 ms <sup>4)</sup>
<b>Switching frequency</b>	100 Hz <sup>5)</sup>
<b>Input</b>	MF <sub>in</sub> = multifunctional input programmable
<b>Connection type</b>	Cable with M12 male connector, 4-pin, 1,547 mm
<b>Conductor cross section</b>	0.14 mm <sup>2</sup>
<b>Cable diameter</b>	Ø 3.4 mm
<b>Circuit protection</b>	A <sup>6)</sup> B <sup>7)</sup> D <sup>8)</sup>
<b>Protection class</b>	III
<b>Weight</b>	10 g
<b>Housing material</b>	Plastic, MABS, ABS
<b>Optics material</b>	Plastic, PMMA
<b>Enclosure rating</b>	IP67
<b>Ambient operating temperature</b>	-40 °C ... +50 °C <sup>9)</sup>

<sup>1)</sup> Limit values. Operated in short-circuit protected network: max. 8 A.

<sup>2)</sup> May not exceed or fall below  $U_V$  tolerances.

<sup>3)</sup> Without load.

<sup>4)</sup> Signal transit time with resistive load.

<sup>5)</sup> With light/dark ratio 1:1.

<sup>6)</sup> A =  $V_S$  connections reverse-polarity protected.

<sup>7)</sup> B = output reverse-polarity protected.

<sup>8)</sup> D = outputs overcurrent and short-circuit protected.

<sup>9)</sup> As of  $T_a = 45 \text{ }^\circ\text{C}$ , a max.load current  $I_{\max} = 50 \text{ mA}$  is permitted.

<sup>10)</sup> Below  $T_U = -10 \text{ }^\circ\text{C}$  a warm-up time is necessary.

<b>Ambient temperature, storage</b>	-40 °C ... +75 °C
<b>Warm-up time</b>	< 10 min <sup>10)</sup>
<b>Initialization time</b>	< 300 ms
<b>UL File No.</b>	E181493

1) Limit values. Operated in short-circuit protected network: max. 8 A.

2) May not exceed or fall below  $U_V$  tolerances.

3) Without load.

4) Signal transit time with resistive load.

5) With light/dark ratio 1:1.

6) A =  $V_S$  connections reverse-polarity protected.

7) B = output reverse-polarity protected.

8) D = outputs overcurrent and short-circuit protected.

9) As of  $T_a = 45$  °C, a max.load current  $I_{max} = 50$  mA is permitted.

10) Below  $T_U = -10$  °C a warm-up time is necessary.

### Safety-related parameters

<b>MTTF<sub>D</sub></b>	256 years
<b>DC<sub>avg</sub></b>	0 %
<b>T<sub>M</sub> (mission time)</b>	10 years

### Communication interface

<b>Communication interface</b>	IO-Link V1.1
<b>Communication Interface detail</b>	COM3 (230,4 kBaud)
<b>Cycle time</b>	0.8 ms
<b>Process data length</b>	4 Byte
<b>Process data structure</b>	Bit 0 = switching signal Q <sub>L1</sub> Bit 1 = switching signal Q <sub>L2</sub> Bit 2 = detection signal Q <sub>int.1</sub> Bit 3 = detection signal Q <sub>int.2</sub> Bit 4 = detection signal Q <sub>int.3</sub> Bit 5 = detection signal Q <sub>int.4</sub> Bit 6 = detection signal Q <sub>int.5</sub> Bit 7 = detection signal Q <sub>int.6</sub> Bit 8 = detection signal Q <sub>int.7</sub> Bit 9 = detection signal Q <sub>int.8</sub> Bit 10 ... 15 = empty Bit 16 ... 31 = distance value
<b>VendorID</b>	26
<b>DeviceID HEX</b>	0x80021D
<b>DeviceID DEC</b>	8389149

### Smart Task

<b>Smart Task name</b>	Base logics
<b>Logic function</b>	Direct AND OR WINDOW Hysteresis
<b>Timer function</b>	Deactivated On delay Off delay ON and OFF delay Impulse (one shot)

<b>Inverter</b>	Yes
<b>Switching signal</b>	
Switching signal Q <sub>L1</sub>	Switching output
Switching signal Q <sub>L2</sub>	Switching output

## Diagnosis

<b>Device temperature</b>	
Measuring range	-127 °C ... +127 °C
<b>Device status</b>	Yes
<b>Operating hour counter</b>	Yes

## Classifications

<b>eCl@ss 5.0</b>	27270904
<b>eCl@ss 5.1.4</b>	27270904
<b>eCl@ss 6.0</b>	27270904
<b>eCl@ss 6.2</b>	27270904
<b>eCl@ss 7.0</b>	27270904
<b>eCl@ss 8.0</b>	27270904
<b>eCl@ss 8.1</b>	27270904
<b>eCl@ss 9.0</b>	27270904
<b>eCl@ss 10.0</b>	27270904
<b>eCl@ss 11.0</b>	27270904
<b>eCl@ss 12.0</b>	27270903
<b>ETIM 5.0</b>	EC002719
<b>ETIM 6.0</b>	EC002719
<b>ETIM 7.0</b>	EC002719
<b>ETIM 8.0</b>	EC002719
<b>UNSPSC 16.0901</b>	39121528

### Dimensional drawing (Dimensions in mm (inch))

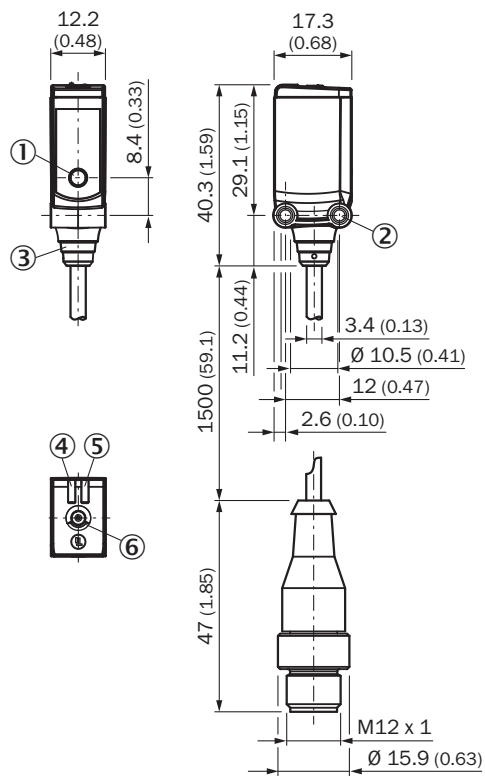

- ① Center of optical axis
- ② Threaded mounting hole M3
- ③ Connection
- ④ LED indicator green: power
- ⑤ LED indicator yellow: Status of received light beam
- ⑥ Single teach-in button

### Connection diagram

Cd-390

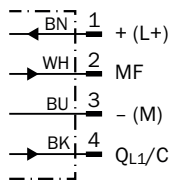

**Characteristic curve**

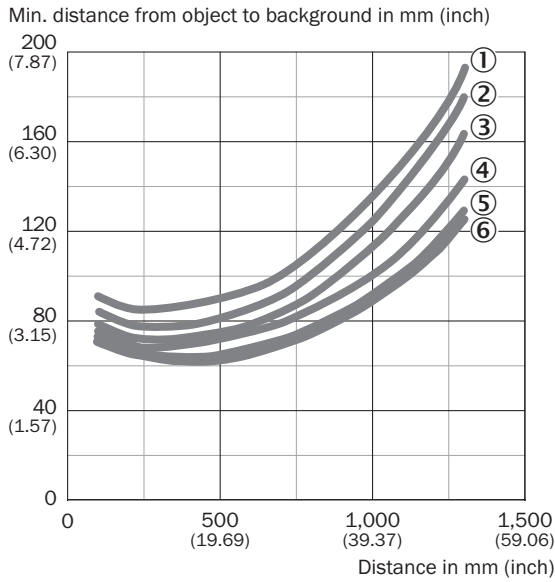

- ① 6 % / 90 % AVG1
- ② 6 % / 90 % AVG2
- ③ 6 % / 90 % AVG4
- ④ 6 % / 90 % AVG8
- ⑤ 6 % / 90 % AVG64
- ⑥ 6 % / 90 % AVG512

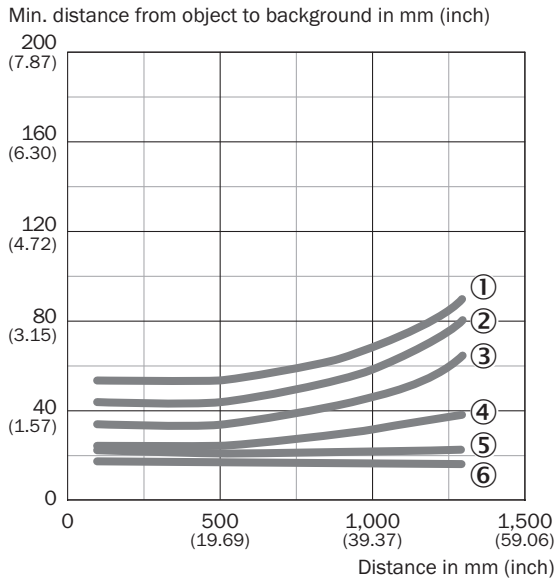

- ① 90 % / 90 % AVG1
- ② 90 % / 90 % AVG2
- ③ 90 % / 90 % AVG4
- ④ 90 % / 90 % AVG8
- ⑤ 90 % / 90 % AVG64
- ⑥ 90 % / 90 % AVG512

### Light spot size

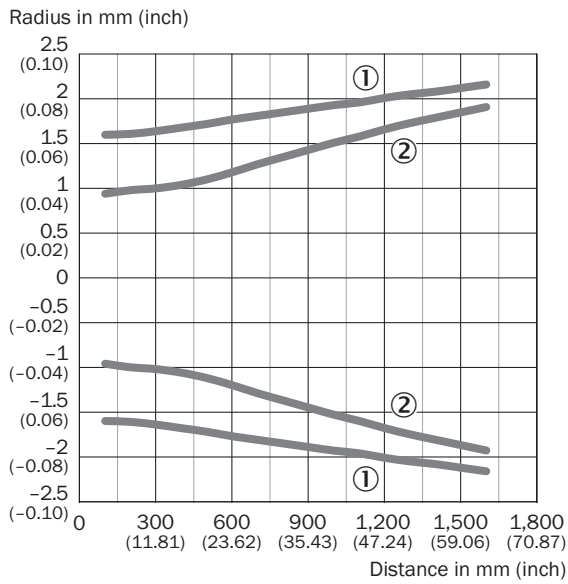

- ① Light spot horizontal
- ② Light spot vertical

### Repeatability

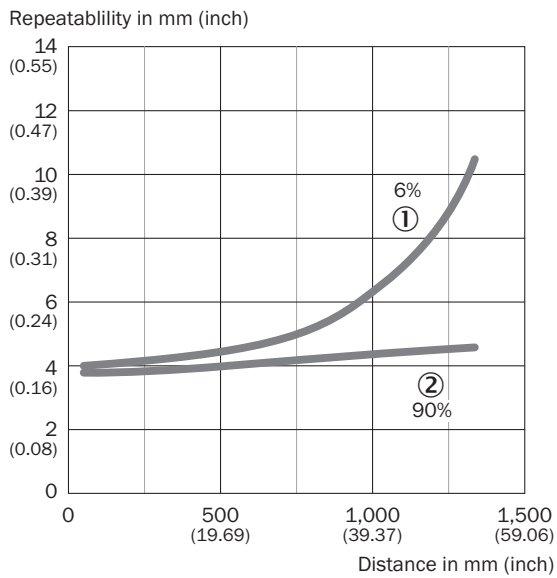

- ① 6 % remission, on black
- ② 90 % remission, on white

## Recommended accessories

Other models and accessories → [www.sick.com/PowerProx](http://www.sick.com/PowerProx)

	Brief description	Type	Part no.
Universal bar clamp systems			
	Plate N08N for universal clamp bracket, Stainless steel 1.4571 (sheet), Stainless steel 1.4408 (clamp), Universal clamp (5322627), mounting hardware	BEF-KHS-N08N	2051616

## SICK AT A GLANCE

SICK is one of the leading manufacturers of intelligent sensors and sensor solutions for industrial applications. A unique range of products and services creates the perfect basis for controlling processes securely and efficiently, protecting individuals from accidents and preventing damage to the environment.

We have extensive experience in a wide range of industries and understand their processes and requirements. With intelligent sensors, we can deliver exactly what our customers need. In application centers in Europe, Asia and North America, system solutions are tested and optimized in accordance with customer specifications. All this makes us a reliable supplier and development partner.

Comprehensive services complete our offering: SICK LifeTime Services provide support throughout the machine life cycle and ensure safety and productivity.

For us, that is “Sensor Intelligence.”

## WORLDWIDE PRESENCE:

Contacts and other locations –[www.sick.com](http://www.sick.com)