



# GTB10-P1212

G10

SMALL PHOTOELECTRIC SENSORS

**SICK**  
Sensor Intelligence.



Illustration may differ



### Ordering information

| Type        | Part no. |
|-------------|----------|
| GTB10-P1212 | 1065856  |

**Included in delivery:** BEF-G10DC01 (1)

Other models and accessories → [www.sick.com/G10](http://www.sick.com/G10)

### Detailed technical data

#### Features

|  |                                |
|--|--------------------------------|
| <b>Functional principle</b>            | Photoelectric proximity sensor |
| <b>Functional principle detail</b>     | Background suppression         |
| <b>Dimensions (W x H x D)</b>          | 20 mm x 50 mm x 39 mm          |
| <b>Housing design (light emission)</b> | Rectangular                    |
| <b>Sensing range max.</b>              | 20 mm ... 950 mm <sup>1)</sup> |
| <b>Type of light</b>                   | Visible red light              |
| <b>Light source</b>                    | PinPoint LED <sup>2)</sup>     |
| <b>Light spot size (distance)</b>      | Ø 8 mm (700 mm)                |
| <b>Wave length</b>                     | 625 nm                         |
| <b>Adjustment</b>                      | Potentiometer, 5 turns         |

<sup>1)</sup> Object with 90% remission (based on standard white, DIN 5033).

<sup>2)</sup> Average service life: 100,000 h at T<sub>U</sub> = +25 °C.

#### Mechanics/electronics

|                       |                                   |
|-----------------------|-----------------------------------|
| <b>Supply voltage</b> | 10 V DC ... 30 V DC <sup>1)</sup> |
|-----------------------|-----------------------------------|

<sup>1)</sup> Limit values when operated in short-circuit protected network: max. 8 A.

<sup>2)</sup> May not exceed or fall below U<sub>V</sub> tolerances.

<sup>3)</sup> Signal transit time with resistive load.

<sup>4)</sup> With light/dark ratio 1:1.

<sup>5)</sup> Do not bend below 0 °C.

<sup>6)</sup> A = V<sub>S</sub> connections reverse-polarity protected.

<sup>7)</sup> B = inputs and output reverse-polarity protected.

<sup>8)</sup> C = interference suppression.

<sup>9)</sup> D = outputs overcurrent and short-circuit protected.

<sup>10)</sup> Complies with the UL325 standard when used with sturdy protection hood (e.g. BEF-G10WSG, 2071960).

|  |  |
|--|--|
| <b>Ripple</b>                              | < 5 V <sub>pp</sub> <sup>2)</sup>  |
| <b>Current consumption</b>                 | 20 mA  |
| <b>Switching output</b>                    | PNP  |
| <b>Switching mode</b>                      | Light/dark switching   |
| <b>Switching mode selector</b>             | Selectable via light/dark selector                                       |
| <b>Output current I<sub>max.</sub></b>     | ≤ 100 mA   |
| <b>Response time</b>                       | ≤ 500 μs <sup>3)</sup>   |
| <b>Switching frequency</b>                 | 1,000 Hz <sup>4)</sup>   |
| <b>Connection type</b>                     | Cable, 3-wire, 2 m <sup>5)</sup>   |
| <b>Cable material</b>                      | PVC  |
| <b>Conductor cross section</b>             | 0.14 mm <sup>2</sup>   |
| <b>Circuit protection</b>                  | A <sup>6)</sup><br>B <sup>7)</sup><br>C <sup>8)</sup><br>D <sup>9)</sup> |
| <b>Protection class</b>                    | III  |
| <b>Weight</b>                              | 90 g   |
| <b>Housing material</b>                    | Plastic, ABS/PMMA  |
| <b>Enclosure rating</b>                    | IP67   |
| <b>Items supplied</b>                      | Mounting bracket BEF-G10DC01   |
| <b>Electromagnetic compatibility (EMC)</b> | EN 60947-5-2   |
| <b>Ambient operating temperature</b>       | -30 °C ... +60 °C  |
| <b>Ambient temperature, storage</b>        | -40 °C ... +70 °C  |
| <b>UL File No.</b>                         | NRKH.E348498 & NRKH7.E348498   |
| <b>More standards</b>                      | UL325 <sup>10)</sup>   |

<sup>1)</sup> Limit values when operated in short-circuit protected network: max. 8 A.

<sup>2)</sup> May not exceed or fall below U<sub>v</sub> tolerances.

<sup>3)</sup> Signal transit time with resistive load.

<sup>4)</sup> With light/dark ratio 1:1.

<sup>5)</sup> Do not bend below 0 °C.

<sup>6)</sup> A = V<sub>S</sub> connections reverse-polarity protected.

<sup>7)</sup> B = inputs and output reverse-polarity protected.

<sup>8)</sup> C = interference suppression.

<sup>9)</sup> D = outputs overcurrent and short-circuit protected.

<sup>10)</sup> Complies with the UL325 standard when used with sturdy protection hood (e.g. BEF-G10WSG, 2071960).

### Safety-related parameters

|                         |             |
|-------------------------|-------------|
| <b>MTTF<sub>D</sub></b> | 1,704 years |
| <b>DC<sub>avg</sub></b> | 0 %         |

### Classifications

|                     |          |
|---------------------|----------|
| <b>eCl@ss 5.0</b>   | 27270904 |
| <b>eCl@ss 5.1.4</b> | 27270904 |
| <b>eCl@ss 6.0</b>   | 27270904 |
| <b>eCl@ss 6.2</b>   | 27270904 |

|                       |          |
|-----------------------|----------|
| <b>eCl@ss 7.0</b>     | 27270904 |
| <b>eCl@ss 8.0</b>     | 27270904 |
| <b>eCl@ss 8.1</b>     | 27270904 |
| <b>eCl@ss 9.0</b>     | 27270904 |
| <b>eCl@ss 10.0</b>    | 27270904 |
| <b>eCl@ss 11.0</b>    | 27270904 |
| <b>eCl@ss 12.0</b>    | 27270903 |
| <b>ETIM 5.0</b>       | EC002719 |
| <b>ETIM 6.0</b>       | EC002719 |
| <b>ETIM 7.0</b>       | EC002719 |
| <b>ETIM 8.0</b>       | EC002719 |
| <b>UNSPSC 16.0901</b> | 39121528 |

### Connection diagram

Cd-044

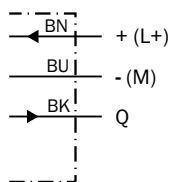

### Characteristic curve

GTB10, redlight

% of sensing range

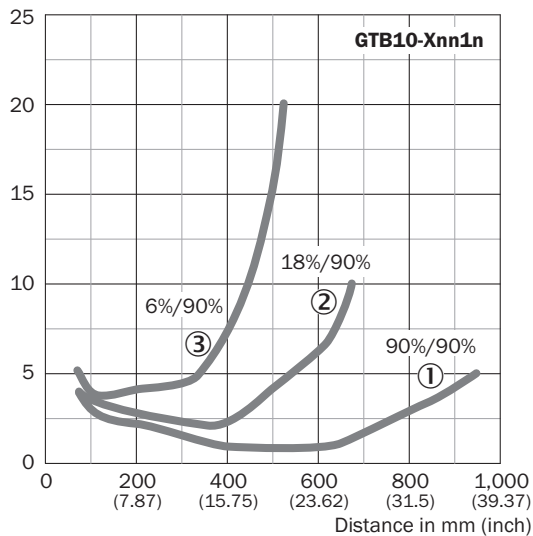

- ① Sensing range on white, 90% remission
- ② Sensing range on gray, 18 % remission
- ③ Sensing range on black, 6% remission

## Light spot size

Light spot size

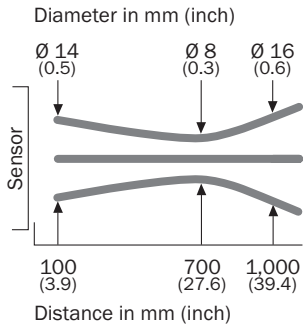

## Sensing range diagram

GTB10, redlight

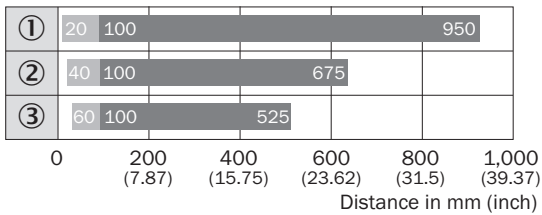

■ Sensing range    ■ Sensing range max.

- ① Sensing range on white, 90% remission
- ② Sensing range on gray, 18 % remission
- ③ Sensing range on black, 6% remission

## Adjustments

GTB10, GTE10, GL10G, DC

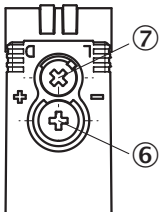

- ⑥ Adjustment of sensing range
- ⑦ Light/dark selector

### Dimensional drawing (Dimensions in mm (inch))

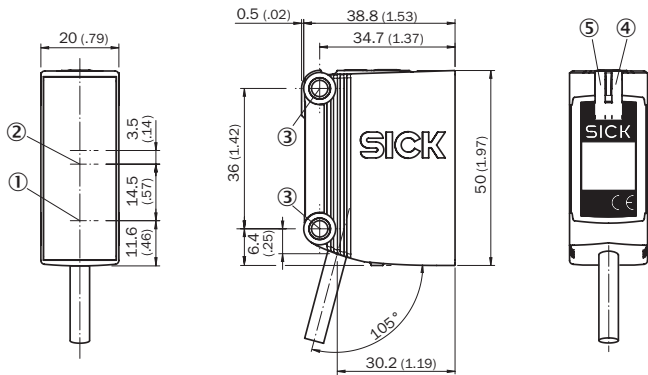

GTB10, DC, cable



- ① Center of optical axis, sender
- ② Center of optical axis, receiver
- ③ Mounting hole, Ø 4.2 mm
- ④ LED indicator yellow: Status of received light beam
- ⑤ LED indicator green: power on

### Recommended accessories

Other models and accessories → [www.sick.com/G10](http://www.sick.com/G10)

|   | Brief description  | Type          | Part no. |
|---|--|---------------|----------|
| Universal bar clamp systems   |  |               |          |
|  | Q-Lock, bar clamp system for G10 and reflector P250, Die-cast zinc, steel, zinc coated | BEF-KHSQ12R01 | 2071260  |
| Plug connectors and cables  |  |               |          |
|  | Head A: male connector, M8, 3-pin, straight<br>Cable: unshielded                       | STE-0803-G    | 6037322  |

## SICK AT A GLANCE

SICK is one of the leading manufacturers of intelligent sensors and sensor solutions for industrial applications. A unique range of products and services creates the perfect basis for controlling processes securely and efficiently, protecting individuals from accidents and preventing damage to the environment.

We have extensive experience in a wide range of industries and understand their processes and requirements. With intelligent sensors, we can deliver exactly what our customers need. In application centers in Europe, Asia and North America, system solutions are tested and optimized in accordance with customer specifications. All this makes us a reliable supplier and development partner.

Comprehensive services complete our offering: SICK LifeTime Services provide support throughout the machine life cycle and ensure safety and productivity.

For us, that is “Sensor Intelligence.”

## WORLDWIDE PRESENCE:

Contacts and other locations –[www.sick.com](http://www.sick.com)