



WSE2S-2F3030S01

W2

MINIATURE PHOTOELECTRIC SENSORS

SICK
Sensor Intelligence.



Illustration may differ



Ordering information

| Type | Part no. |
|-----------------|----------|
| WSE2S-2F3030S01 | 1068155 |

Other models and accessories → www.sick.com/W2

Detailed technical data

Features

| | |
|--|-----------------------------------|
| Functional principle | Through-beam photoelectric sensor |
| Dimensions (W x H x D) | 7.7 mm x 21.8 mm x 13.5 mm |
| Housing design (light emission) | Rectangular |
| Sensing range max. | 0 m ... 2.5 m |
| Sensing range | 0 m ... 2 m |
| Type of light | Visible red light |
| Light source | PinPoint LED ¹⁾ |
| Light spot size (distance) | Ø 65 mm (1,500 mm) |
| Wave length | 640 nm |
| Adjustment | None |

¹⁾ Average service life: 100,000 h at T_J = +25 °C.

Mechanics/electronics

| | |
|-------------------------------------|-----------------------------------|
| Supply voltage U_B | 10 V DC ... 30 V DC ¹⁾ |
| Ripple | < 5 V _{pp} ²⁾ |

¹⁾ Limit values.

²⁾ May not exceed or fall below U_v tolerances.

³⁾ Without load.

⁴⁾ Signal transit time with resistive load.

⁵⁾ With light/dark ratio 1:1.

⁶⁾ Do not bend below 0 °C.

⁷⁾ A = V_S connections reverse-polarity protected.

⁸⁾ B = output reverse-polarity protected.

⁹⁾ D = outputs overcurrent and short-circuit protected.

| | |
|---|---|
| Current consumption | 20 mA ³⁾ |
| Switching output | PNP |
| Switching mode | Dark switching |
| Output current I_{max.} | ≤ 50 mA |
| Response time | < 0.4 ms ⁴⁾ |
| Switching frequency | 1,200 Hz ⁵⁾ |
| Connection type | Cable with connector M8, 3-pin, 700 mm ⁶⁾ |
| Cable material | PVC |
| Conductor cross section | 0.09 mm ² |
| Cable diameter | Ø 3 mm |
| Circuit protection | A ⁷⁾ B ⁸⁾ D ⁹⁾ |
| Special device | ✓ |
| Housing material | Plastic, ABS/PC |
| Optics material | Plastic, PMMA |
| Enclosure rating | IP67 |
| Ambient operating temperature | -25 °C ... +50 °C |
| Ambient temperature, storage | -40 °C ... +75 °C |
| UL File No. | NRKH.E181493 |
| Part number of individual components | 2069158 WSE2S-2P 2071150 WSE2S-2 |

- 1) Limit values.
- 2) May not exceed or fall below U_v tolerances.
- 3) Without load.
- 4) Signal transit time with resistive load.
- 5) With light/dark ratio 1:1.
- 6) Do not bend below 0 °C.
- 7) A = V_S connections reverse-polarity protected.
- 8) B = output reverse-polarity protected.
- 9) D = outputs overcurrent and short-circuit protected.

Classifications

| | |
|---------------------|----------|
| ECLASS 5.0 | 27270901 |
| ECLASS 5.1.4 | 27270901 |
| ECLASS 6.0 | 27270901 |
| ECLASS 6.2 | 27270901 |
| ECLASS 7.0 | 27270901 |
| ECLASS 8.0 | 27270901 |
| ECLASS 8.1 | 27270901 |
| ECLASS 9.0 | 27270901 |
| ECLASS 10.0 | 27270901 |
| ECLASS 11.0 | 27270901 |
| ECLASS 12.0 | 27270901 |
| ETIM 5.0 | EC002716 |

| | |
|-----------------------|----------|
| ETIM 6.0 | EC002716 |
| ETIM 7.0 | EC002716 |
| ETIM 8.0 | EC002716 |
| UNSPSC 16.0901 | 39121528 |

Connection diagram

Cd-051

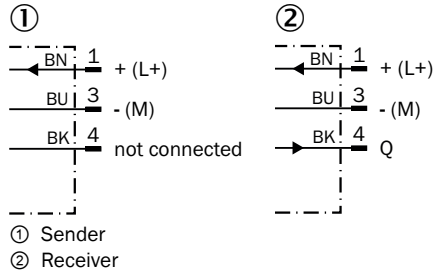

Characteristic curve

WSE2S-2

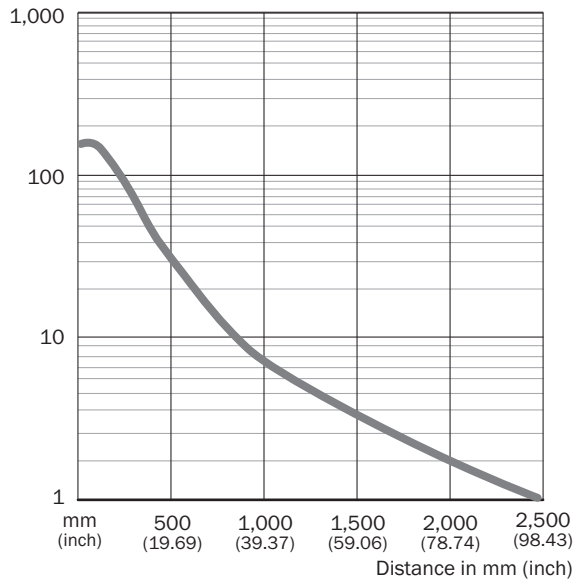

Light spot size

WSE2S-2

Spot diameter in mm (inch)

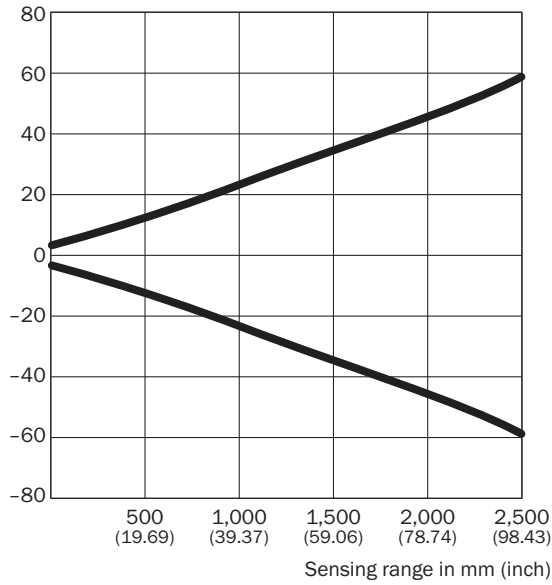

Dimensions in mm (inch)

| Sensing range | Spot diameter |
|-------------------------|-----------------|
| 10 (0.39) | 4.0 (0.16) |
| 250 (9.84) | 13.0 (0.51) |
| 500 (19.69) | 23.0 (0.91) |
| 1,000 (39.37) | 45.0 (1.77) |
| 1,500 (59.06) | 65.0 (2.56) |
| 2,500 (98.43) | 116.0 (4.57) |

Sensing range diagram

WSE2S-2

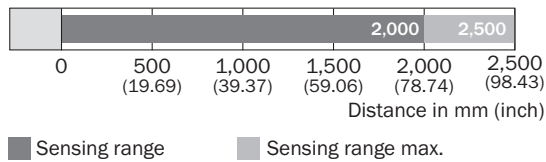

Dimensional drawing (Dimensions in mm (inch))

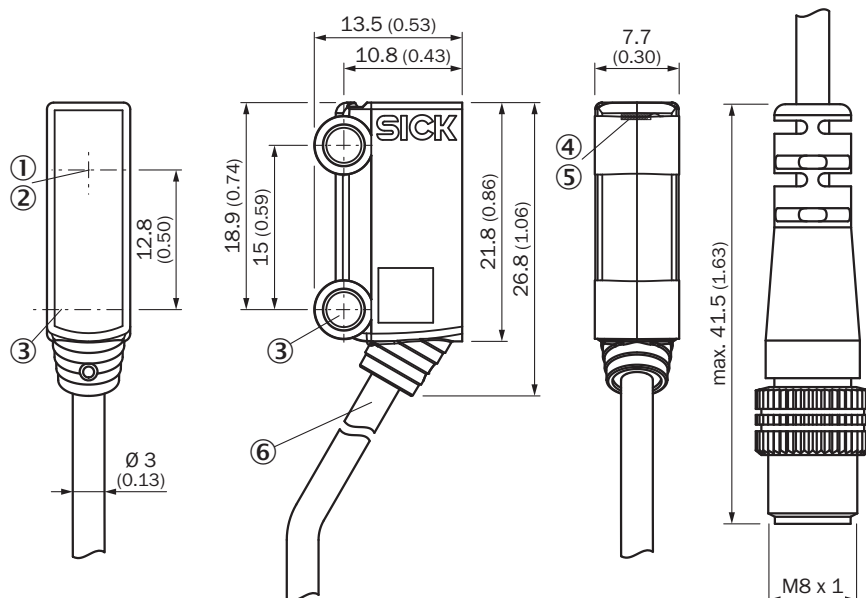

WSE2S-2



- ① Optical axis, receiver
- ② Optical axis, sender
- ③ Middle axis fixing hole \varnothing 3.2 mm
- ④ LED indicator green: power on
- ⑤ LED indicator yellow: Status of received light beam
- ⑥ Connection

Recommended accessories

Other models and accessories → www.sick.com/W2

| | Brief description | Type | Part no. |
|---|--|--------------------|----------|
| Plug connectors and cables | | | |
|  | <ul style="list-style-type: none"> • Connection type head A: Female connector, M8, 3-pin, straight, A-coded • Connection type head B: Flying leads • Signal type: Sensor/actuator cable • Cable: 5 m, 3-wire, PVC • Description: Sensor/actuator cable, unshielded • Application: Zones with chemicals | YF8U13-050VA1XLEAX | 2095884 |
|  | <ul style="list-style-type: none"> • Connection type head A: Male connector, M8, 3-pin, straight • Description: Unshielded • Connection systems: Screw-type terminals • Permitted cross-section: 0.14 mm² ... 0.5 mm² | STE-0803-G | 6037322 |

SICK AT A GLANCE

SICK is one of the leading manufacturers of intelligent sensors and sensor solutions for industrial applications. A unique range of products and services creates the perfect basis for controlling processes securely and efficiently, protecting individuals from accidents and preventing damage to the environment.

We have extensive experience in a wide range of industries and understand their processes and requirements. With intelligent sensors, we can deliver exactly what our customers need. In application centers in Europe, Asia and North America, system solutions are tested and optimized in accordance with customer specifications. All this makes us a reliable supplier and development partner.

Comprehensive services complete our offering: SICK LifeTime Services provide support throughout the machine life cycle and ensure safety and productivity.

For us, that is “Sensor Intelligence.”

WORLDWIDE PRESENCE:

Contacts and other locations –www.sick.com