



IMS18-08BPSZC0SS03

IMS

INDUCTIVE PROXIMITY SENSORS

SICK
Sensor Intelligence.



Ordering information

Type	Part no.
IMS18-08BPSZCOSS03	1112343

Included in delivery: BEF-MU-M18 (1)

Other models and accessories → www.sick.com/IMS

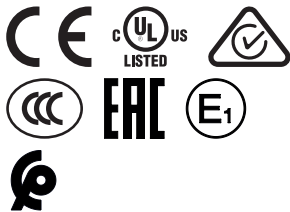

Detailed technical data

Features

Housing	Cylindrical thread design
Housing	Standard design
Thread size	M18 x 1
Diameter	Ø 18 mm
Sensing range S_n	8 mm
Safe sensing range S_a	6.48 mm
Installation type	Flush
Switching frequency	1,000 Hz
Connection type	Male connector M12, 4-pin ¹⁾
Switching output	PNP
Output function	NO
Electrical wiring	DC 3-wire
Enclosure rating	IP68 ²⁾ IP69K ³⁾
Special features	Resistant against coolant lubricants, Temperature resistance
Special applications	Mobile machines, Zones with coolants and lubricants, Difficult application conditions
Items supplied	Mounting nut, brass, nickel-plated (2x)

¹⁾ With gold plated contact pins.

²⁾ According to EN 60529.

³⁾ According to ISO 20653:2013-03.

Mechanics/electronics

Supply voltage	7.2 V DC ... 60 V DC
-----------------------	----------------------

¹⁾ At I_a max.

²⁾ Supply voltage U_b and constant ambient temperature T_a .

³⁾ See "Continuous current I_a above temperature" characteristic curve.

Ripple	≤ 10 %
Voltage drop	≤ 2.5 V ¹⁾
Time delay before availability	100 ms
Hysteresis	3 % ... 20 %
Reproducibility	≤ 2 % ²⁾
Temperature drift (of S_r)	± 10 %
EMC	<p>Emitted interference and interference immunity in accordance with Motor Insurance Directive ECE-R10 Rev. 5: E1-Type approval</p> <p>Interference immunity in accordance with DIN ISO 11452-2: 100 V/m AM vertical 20 MHz - 800 MHz; AM horizontal 200 MHz - 800 MHz; PM vertical/horizontal 800 MHz - 2.7 GHz</p> <p>Conducted disturbances in accordance with ISO 7637-2 (pulse/severity/failure criterion 12 V/failure criterion 24 V): 1/IV/C/C, 2a/IV/A/A, 2b/IV/C/C, 3a/IV/A/A, 3b/IV/A/A, 4/IV/C/A, 5a/IV/B/B, 5b/IV/B/B</p> <p>EN 61000-4-2 ESD: 4 kV CD / 8 kV AD EN 61000-4-3 HF radiated: 10 V/m EN 61000-4-4 burst: 2 kV EN 61000-4-5 surge: 0,5 kV L-to-L, Ri: 2 Ohm EN 61000-4-6 HF wire-bound: 10 V</p>
Environmental test	Quick temperature change EN 60068-2-14, Na: TA = -25 °C, TB = 75 °C, t1 = 40 min, t2 = < 10 s, 300 cycles, Delta S _r ≤ 10%
Continuous current I_a	≤ 200 mA ³⁾
No load current	≤ 10 mA
Short-circuit protection	✓
Reverse polarity protection	✓
Power-up pulse protection	✓
Shock and vibration resistance	<p>Vibration resistance EN 60068-2-6 Fc: 25 g peak (10 Hz ... 2,000 Hz) / -20 °C ... +50 °C</p> <p>Shock resistance EN 60068-2-27 Ea: 100 g 11 ms; 3 shocks in every direction of the 3 coordinate axes / -40 °C ... +85 °C</p> <p>Continuous shock resistance EN 60068-2-29 Eb: 40 g 3 ms rise, 7 ms fall / 5,000 shocks in every direction of the 3 coordinate axes / -20 °C ... +50 °C</p> <p>Broadband noise EN 60068-2-64: 15 g rms (5 Hz ... 2,000 Hz) / 8 hours in every direction of the 3 coordinate axes / -40 °C ... +85 °C</p>
Ambient operating temperature	-40 °C ... +100 °C
Housing material	Brass, nickel-plated
Sensing face material	Plastic, LCP
Housing length	69 mm
Thread length	51 mm
Tightening torque, max.	≤ 30 Nm
Protection class	III
UL File No.	E181493

¹⁾ At I_a max.

²⁾ Supply voltage U_b and constant ambient temperature T_a.

³⁾ See "Continuous current I_a above temperature" characteristic curve.

Safety-related parameters

DC_{avg}	0 %
-------------------------	-----

Reduction factors

Note	The values are reference values which may vary
-------------	--

Stainless steel (V2A, 304)	Approx. 0.68
Aluminum (Al)	Approx. 0.41
Copper (Cu)	Approx. 0.3
Brass (Br)	Approx. 0.44

Installation note

Remark	Associated graphic see "Installation"
B	18 mm
C	18 mm
D	24 mm
F	64 mm

Classifications

eCl@ss 5.0	27270101
eCl@ss 5.1.4	27270101
eCl@ss 6.0	27270101
eCl@ss 6.2	27270101
eCl@ss 7.0	27270101
eCl@ss 8.0	27270101
eCl@ss 8.1	27270101
eCl@ss 9.0	27270101
eCl@ss 10.0	27270101
eCl@ss 11.0	27270101
eCl@ss 12.0	27274001
ETIM 5.0	EC002714
ETIM 6.0	EC002714
ETIM 7.0	EC002714
ETIM 8.0	EC002714
UNSPSC 16.0901	39122230

Installation note

Flush installation

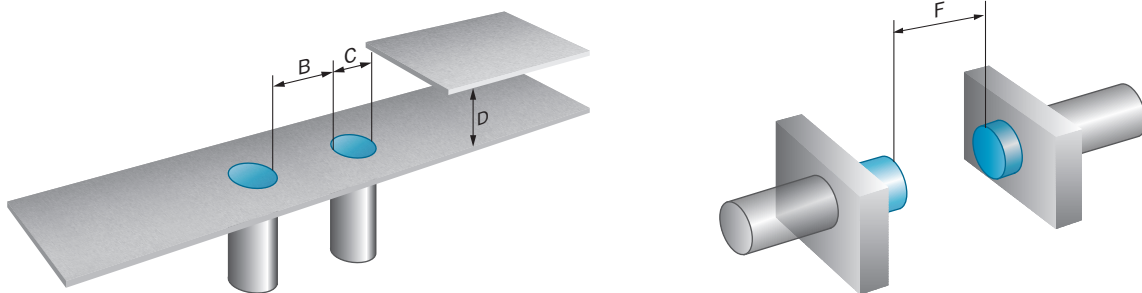

Connection diagram

Cd-007

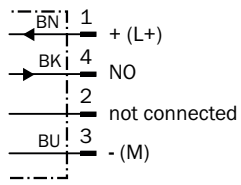

Temperature derating

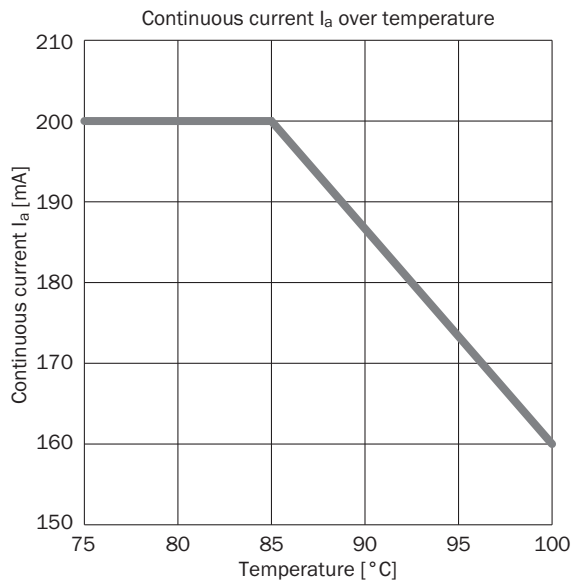

Response diagram

Response diagram

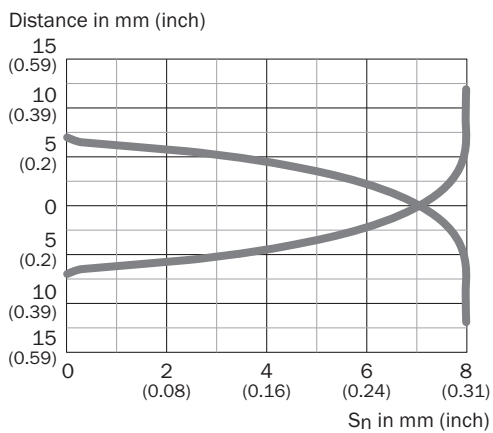

Dimensional drawing (Dimensions in mm (inch))

IMS18, flush

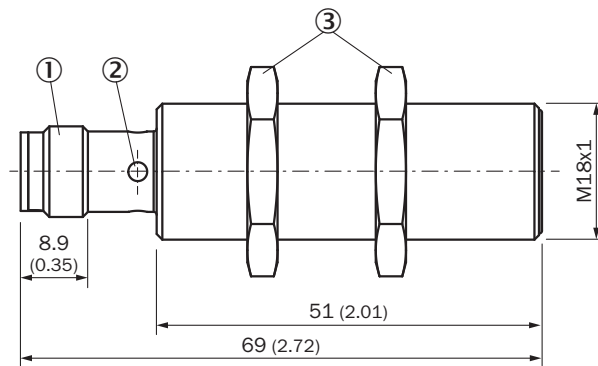

- ① Connection
- ② Display LED
- ③ Fastening nuts (2x); width across 24, brass nickel-plated

Recommended accessories

Other models and accessories → www.sick.com/IMS

	Brief description	Type	Part no.
Universal bar clamp systems			
	Plate N06N for universal clamp bracket, M18, Stainless steel 1.4571 (sheet), Stainless steel 1.4408 (clamp), Universal clamp (5322627), mounting hardware	BEF-KHS-N06N	2051622

SICK AT A GLANCE

SICK is one of the leading manufacturers of intelligent sensors and sensor solutions for industrial applications. A unique range of products and services creates the perfect basis for controlling processes securely and efficiently, protecting individuals from accidents and preventing damage to the environment.

We have extensive experience in a wide range of industries and understand their processes and requirements. With intelligent sensors, we can deliver exactly what our customers need. In application centers in Europe, Asia and North America, system solutions are tested and optimized in accordance with customer specifications. All this makes us a reliable supplier and development partner.

Comprehensive services complete our offering: SICK LifeTime Services provide support throughout the machine life cycle and ensure safety and productivity.

For us, that is “Sensor Intelligence.”

WORLDWIDE PRESENCE:

Contacts and other locations –www.sick.com