



IMB18-08BPSVU6S

IMB

INDUCTIVE PROXIMITY SENSORS

SICK
Sensor Intelligence.



Illustration may differ



Ordering information

| Type | Part no. |
|-----------------|----------|
| IMB18-08BPSVU6S | 1086561 |

Included in delivery: BEF-MU-M18N (1)

Other models and accessories → www.sick.com/IMB

Detailed technical data

Features

| | |
|--|--|
| Housing | Cylindrical thread design |
| Housing | Standard design |
| Thread size | M18 x 1 |
| Diameter | Ø 18 mm |
| Sensing range S_n | 8 mm |
| Safe sensing range S_a | 6.48 mm |
| Installation type | Quasi-flush ¹⁾ |
| Switching frequency | 1,000 Hz |
| Connection type | Cable, 3-wire, 10 m |
| Switching output | PNP |
| Output function | NO |
| Electrical wiring | DC 3-wire |
| Enclosure rating | IP68 ²⁾ IP69K ³⁾ |
| Special features | Resistant against coolant lubricants, Visual adjustment indicator, IO-Link, Temperature resistance |
| Special applications | Zones with coolants and lubricants, Mobile machines, Difficult application conditions |
| Items supplied | Mounting nut, V2A stainless steel, with locking teeth (2x) |

¹⁾ When installed in conductive materials, the sensors must protrude by distance E (E = 2 mm).

²⁾ According to EN 60529.

³⁾ According to ISO 20653:2013-03.

Mechanics/electronics

| | |
|---|--|
| Supply voltage | 10 V DC ... 30 V DC |
| Ripple | ≤ 10 % |
| Voltage drop | ≤ 2 V ¹⁾ |
| Hysteresis | 3 % ... 20 % |
| Reproducibility | ≤ 2 % ^{2) 3)} |
| Temperature drift (of S_r) | ± 10 % |
| EMC | According to EN 60947-5-2 |
| Continuous current I_a | ≤ 200 mA |
| No load current | ≤ 10 mA |
| Cable material | PUR |
| Conductor size | 0.34 mm ² |
| Cable diameter | Ø 4.5 mm |
| Short-circuit protection | ✓ |
| Reverse polarity protection | ✓ |
| Power-up pulse protection | ✓ |
| Shock and vibration resistance | 100 g / 2 ms / 500 cycles; 150 g / 1 Mio cycles; 10 Hz ... 55 Hz / 1 mm; 55 Hz ... 500 Hz / 60 g |
| Ambient operating temperature | -40 °C ... +100 °C |
| Housing material | Stainless steel V2A, DIN 1.4305 / AISI 303 |
| Sensing face material | Plastic, LCP |
| Housing length | 50 mm |
| Thread length | 45 mm |
| Tightening torque, max. | Typ. 60 Nm ⁴⁾ Typ. 90 Nm ⁵⁾ |
| Protection class | III |
| UL File No. | E181493 |

¹⁾ At I_a max.

²⁾ Supply voltage U_b and constant ambient temperature T_a.

³⁾ Of S_r.

⁴⁾ When using the non-toothed side of the nut.

⁵⁾ Valid if toothed side of nut is used.

Safety-related parameters

| | |
|-------------------------|-------------|
| MTTF_D | 1,971 years |
| DC_{avg} | 0 % |

Communication interface

| | |
|---------------------------------------|--|
| Communication interface | IO-Link V1.0 |
| Communication Interface detail | COM2 (38,4 kBaud) |
| Process data length | 1 Byte |
| Process data structure | Bit 0 = S _r reached Bit 1 = S _a reached |

Reduction factors

| | |
|-----------------------------------|--|
| Note | The values are reference values which may vary |
| St37 steel (Fe) | 1 |
| Stainless steel (V2A, 304) | Approx. 0.55 |
| Aluminum (Al) | Approx. 0.24 |
| Copper (Cu) | Approx. 0.19 |
| Brass (Br) | Approx. 0.24 |

Installation note

| | |
|---------------|---------------------------------------|
| Remark | Associated graphic see "Installation" |
| A | 9 mm |
| B | 18 mm |
| C | 18 mm |
| D | 24 mm |
| E | 2 mm |
| F | 64 mm |

Classifications

| | |
|-----------------------|----------|
| ECLASS 5.0 | 27270101 |
| ECLASS 5.1.4 | 27270101 |
| ECLASS 6.0 | 27270101 |
| ECLASS 6.2 | 27270101 |
| ECLASS 7.0 | 27270101 |
| ECLASS 8.0 | 27270101 |
| ECLASS 8.1 | 27270101 |
| ECLASS 9.0 | 27270101 |
| ECLASS 10.0 | 27270101 |
| ECLASS 11.0 | 27270101 |
| ECLASS 12.0 | 27274001 |
| ETIM 5.0 | EC002714 |
| ETIM 6.0 | EC002714 |
| ETIM 7.0 | EC002714 |
| ETIM 8.0 | EC002714 |
| UNSPSC 16.0901 | 39122230 |

Adjustments

Installation aid

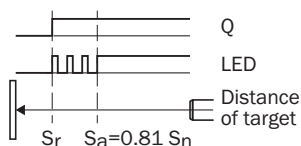

Installation note

Quasi-flush installation

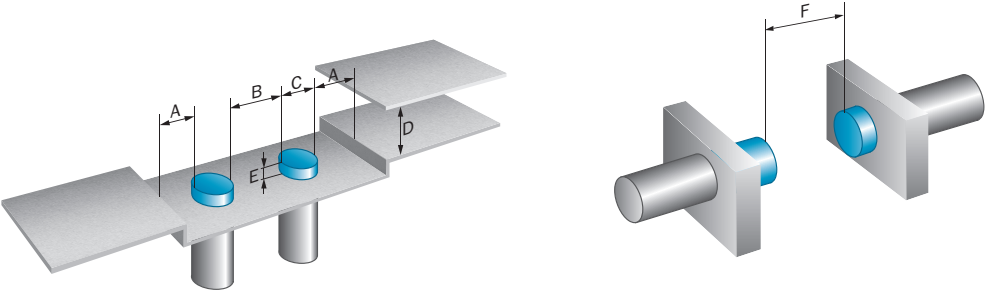

Connection diagram

Cd-452

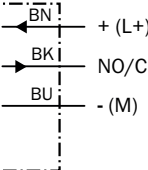

Response diagram

Response diagram

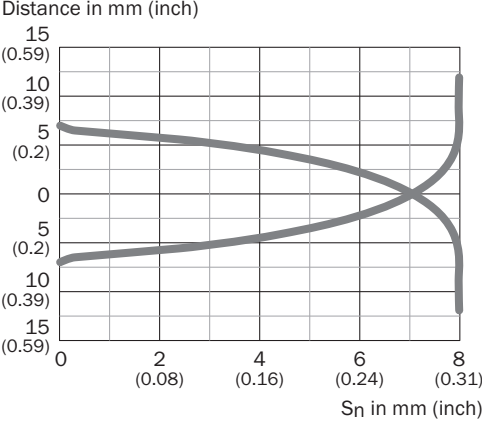

Dimensional drawing (Dimensions in mm (inch))



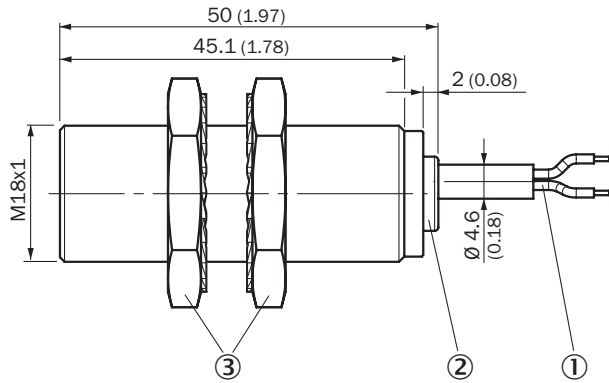



IMB18 Standard, cable, flush



- ① Connection
- ② Display LED
- ③ Fastening nuts (2 x); width across 24, stainless steel V2A

Recommended accessories

Other models and accessories → www.sick.com/IMB

| | Brief description | Type | Part no. |
|---|---|--------------|----------|
| Universal bar clamp systems | | | |
|  | Plate N06N for universal clamp bracket, M18, Stainless steel 1.4571 (sheet), Stainless steel 1.4408 (clamp), Universal clamp (5322627), mounting hardware | BEF-KHS-N06N | 2051622 |
| Mounting brackets and plates | | | |
|  | Mounting plate for M18 sensors, stainless steel, without mounting hardware | BEF-WG-M18N | 5320948 |
|  | Mounting bracket for M18 sensors, stainless steel, without mounting hardware | BEF-WN-M18N | 5320947 |
| Plug connectors and cables | | | |
|  | Head A: female connector, M12, 4-pin, straight Cable: unshielded | DOS-1204-GN | 6028357 |
|  | Head A: female connector, M12, 4-pin, angled Cable: unshielded | DOS-1204-WN | 6028358 |
|  | Head A: male connector, M12, 4-pin, straight Cable: unshielded | STE-1204-GN | 6028359 |
|  | Head A: male connector, M12, 4-pin, straight Cable: unshielded For 2 cable connections | STE-1204-TN | 6028360 |

SICK AT A GLANCE

SICK is one of the leading manufacturers of intelligent sensors and sensor solutions for industrial applications. A unique range of products and services creates the perfect basis for controlling processes securely and efficiently, protecting individuals from accidents and preventing damage to the environment.

We have extensive experience in a wide range of industries and understand their processes and requirements. With intelligent sensors, we can deliver exactly what our customers need. In application centers in Europe, Asia and North America, system solutions are tested and optimized in accordance with customer specifications. All this makes us a reliable supplier and development partner.

Comprehensive services complete our offering: SICK LifeTime Services provide support throughout the machine life cycle and ensure safety and productivity.

For us, that is “Sensor Intelligence.”

WORLDWIDE PRESENCE:

Contacts and other locations –www.sick.com