



WSE4SLC-3P2236A00

W4

MINIATURE PHOTOELECTRIC SENSORS

SICK
Sensor Intelligence.



Illustration may differ

Ordering information

Type	Part no.
WSE4SLC-3P2236A00	1080957

Other models and accessories → www.sick.com/W4



Detailed technical data

Features

Functional principle	Through-beam photoelectric sensor
Sensing range max.	0 m ... 60 m
Sensing range	0 m ... 50 m
Emitted beam	
Light source	Laser ¹⁾
Type of light	Visible red light
Light spot size (distance)	Ø 1 mm (500 mm)
Key laser figures	
Normative reference	EN 60825-1:2014, IEC 60825-1:2014 / CDRH 21 CFR 1040.10 & 1040.11
Laser class	1
Wave length	650 nm
Adjustment	IO-Link
Special applications	Detecting small objects
Part number of individual components	2064095 WS4SL-3D2236, 2088186 WE4SLC-3P2230A00
Mounting hole	M3
Pin 2 configuration	External input, Detection output, logic output, alarm output operating reserve

¹⁾ Average service life: 50,000 h at T_U = +25 °C.

Safety-related parameters

MTTF_D	405 years (EN ISO 13849-1) ¹⁾
DC_{avg}	0 %
T_M (mission time)	10 years

¹⁾ Mode of calculation: Parts-Count-calculation.

Communication interface

IO-Link	✓, COM2 (38,4 kBaud)
Data transmission rate	COM2 (38,4 kBaud)
Cycle time	2.3 ms
Process data length	16 Bit
Process data structure	Bit 0 = switching signal Q _{L1} Bit 1 = switching signal Q _{L2} Bit 2 ... 15 = empty
VendorID	26
DeviceID HEX	0x80011B
DeviceID DEC	8388891

Electrical data

Supply voltage U_B	10 V DC ... 30 V DC ¹⁾
Ripple	< 5 V _{pp} ²⁾
Current consumption	30 mA ³⁾
Protection class	III
Digital output	
Type	PNP ^{4) 5)}
Switching mode	Light/dark switching ⁴⁾
Output current I _{max}	≤ 100 mA
Response time	≤ 0.5 ms ⁶⁾
Repeatability (response time)	150 μs ⁷⁾
Switching frequency	1,000 Hz ⁸⁾
Output function	Complementary
Circuit protection	A ⁹⁾ B ¹⁰⁾ C ¹¹⁾

¹⁾ Limit values when operated in short-circuit protected network: max. 8 A.

²⁾ May not exceed or fall below U_v tolerances.

³⁾ Without load.

⁴⁾ Q = light switching.

⁵⁾ Pin 4: This switching output must not be connected to another output.

⁶⁾ Signal transit time with resistive load.

⁷⁾ Valid for Q \ on Pin2, if configured with software.

⁸⁾ With light/dark ratio 1:1.

⁹⁾ A = V_S connections reverse-polarity protected.

¹⁰⁾ B = inputs and output reverse-polarity protected.

¹¹⁾ C = interference suppression.

¹²⁾ With light / dark ratio 1:1, valid for Q \ on Pin2, if configured with software.

Switching frequency Q / to pin 2	1,000 Hz ¹²⁾
---	-------------------------

- 1) Limit values when operated in short-circuit protected network: max. 8 A.
- 2) May not exceed or fall below U_V tolerances.
- 3) Without load.
- 4) Q = light switching.
- 5) Pin 4: This switching output must not be connected to another output.
- 6) Signal transit time with resistive load.
- 7) Valid for Q \ on Pin2, if configured with software.
- 8) With light/dark ratio 1:1.
- 9) A = V_S connections reverse-polarity protected.
- 10) B = inputs and output reverse-polarity protected.
- 11) C = interference suppression.
- 12) With light / dark ratio 1:1, valid for Q \ on Pin2, if configured with software.

Mechanical data

Housing	Rectangular
Design detail	Slim
Dimensions (W x H x D)	12.2 mm x 41.8 mm x 17.3 mm
Connection	Male connector M8, 4-pin
Material	
Housing	Plastic, Novodur
Front screen	Plastic, PMMA
Weight	100 g

Ambient data

Enclosure rating	IP66 IP67
Ambient operating temperature	-10 °C ... +50 °C
Ambient operating temperature extended	-30 °C ... +55 °C ^{1) 2)}
Ambient temperature, storage	-30 °C ... +70 °C

- 1) As of $T_a = 50$ °C, a max. supply voltage $V_{max} = 24$ V and a max. load current $I_{max} = 50$ mA is permitted.
- 2) Operation below $T_u -10$ °C is possible if the sensor is already switched on at $T_u > -10$ °C, then cools down, and the supply voltage is subsequently not switched off. Switching on below $T_u -10$ °C is not permissible.

Smart Task

Smart Task name	Base logics
Logic function	Direct AND OR Hysteresis
Timer function	Deactivated On delay Off delay ON and OFF delay Impulse (one shot)
Inverter	Yes
Switching frequency	SIO Direct: 1000 Hz ¹⁾

- 1) SIO Direct: sensor operation in standard I/O mode without IO-Link communication and without using internal sensor logic or time parameters (set to "direct"/"deactivated").
- 2) SIO Logic: Sensor operation in standard I/O mode without IO-Link communication. Sensor-internal logic or timing parameters plus Automation Functions used.
- 3) IOL: Sensor operation with full IO-Link communication and usage of logic, timing and Automation Function parameters.

	SIO Logic: 1000 Hz ²⁾ IOL: 900 Hz ³⁾
Response time	SIO Direct: 300 µs ... 450 µs ¹⁾ SIO Logic: 500 µs ... 600 µs ²⁾ IOL: 500 µs ... 900 µs ³⁾
Repeatability	SIO Direct: 150 µs ¹⁾ SIO Logic: 150 µs ²⁾ IOL: 400 µs ³⁾
Switching signal	
Switching signal Q _{L1}	Switching output
Switching signal Q _{L2}	Switching output

¹⁾ SIO Direct: sensor operation in standard I/O mode without IO-Link communication and without using internal sensor logic or time parameters (set to "direct"/"deactivated").

²⁾ SIO Logic: Sensor operation in standard I/O mode without IO-Link communication. Sensor-internal logic or timing parameters plus Automation Functions used.

³⁾ IOL: Sensor operation with full IO-Link communication and usage of logic, timing and Automation Function parameters.

Diagnosis

Device status	Yes
Function reserve	Yes

Classifications

ECLASS 5.0	27270901
ECLASS 5.1.4	27270901
ECLASS 6.0	27270901
ECLASS 6.2	27270901
ECLASS 7.0	27270901
ECLASS 8.0	27270901
ECLASS 8.1	27270901
ECLASS 9.0	27270901
ECLASS 10.0	27270901
ECLASS 11.0	27270901
ECLASS 12.0	27270901
ETIM 5.0	EC002716
ETIM 6.0	EC002716
ETIM 7.0	EC002716
ETIM 8.0	EC002716
UNSPSC 16.0901	39121528

Connection diagram

Cd-376

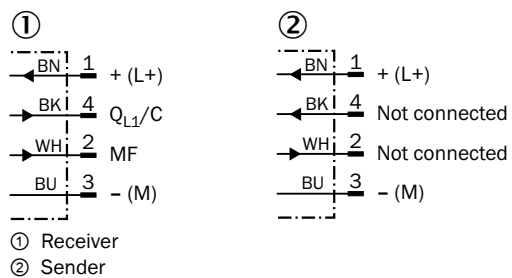

Characteristic curve

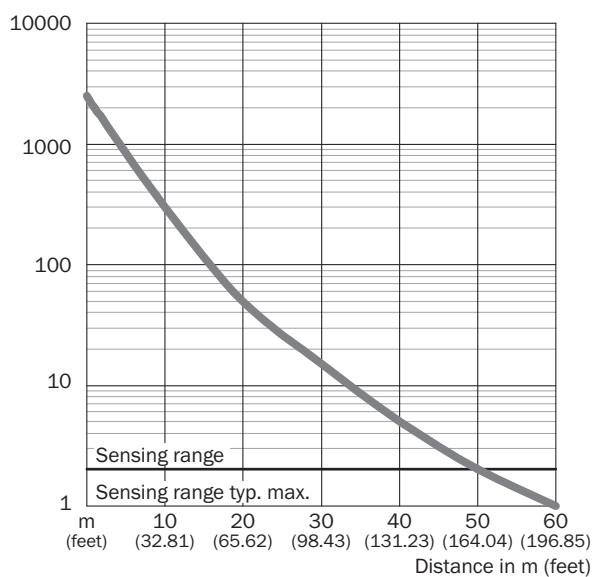

Light spot size

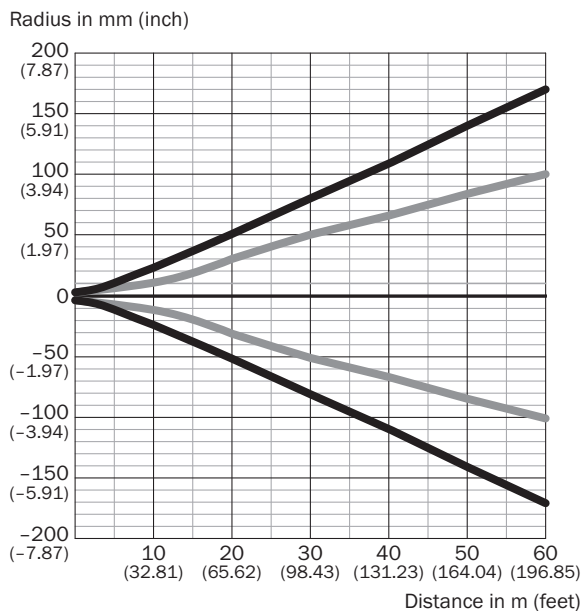

Dimensions in mm (inch)

Sensing range	Vertical	Horizontal
0.5 m (1.64 feet)	< 1.0 (0.04)	< 1.0 (0.04)
1 m (3.28 feet)	1.5 (0.06)	1.2 (0.05)
5 m (16.40 feet)	15 (0.59)	11 (0.43)
10 m (32.81 feet)	45 (1.77)	28 (1.10)
60 m (196.85 feet)	336 (13.23)	200 (7.87)

— Vertical
 — Horizontal

Light spot size (detailed view)

Detailed view close range

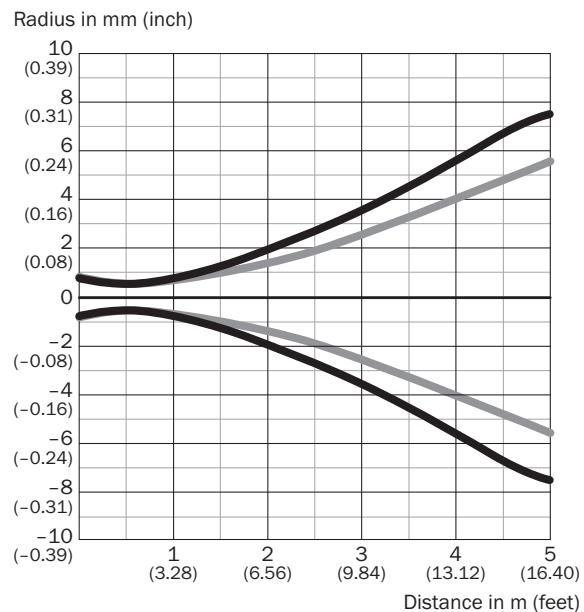

— Vertical
 — Horizontal

Sensing range diagram

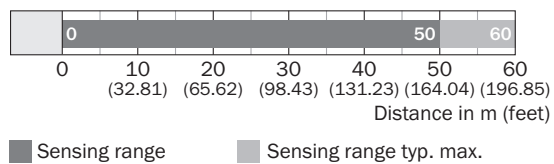

Dimensional drawing (Dimensions in mm (inch))

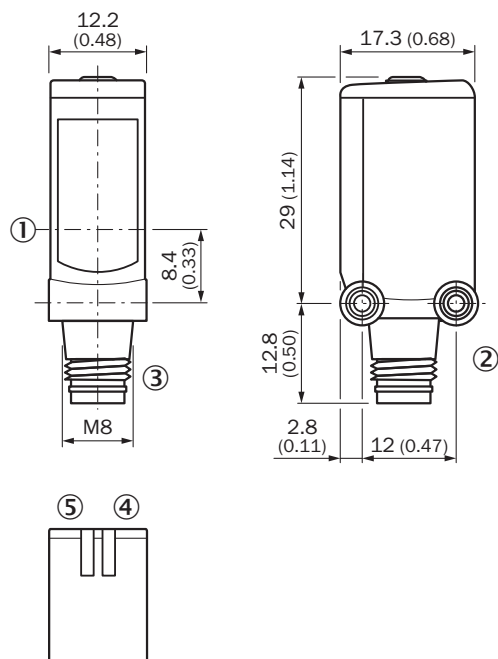

- ① Center of optical axis
- ② Threaded mounting hole M3
- ③ Connection
- ④ LED indicator green: Supply voltage active
- ⑤ LED indicator yellow: Status of received light beam

Recommended accessories

Other models and accessories → www.sick.com/W4

	Brief description	Type	Part no.
Plug connectors and cables			
	<ul style="list-style-type: none"> • Connection type head A: Female connector, M8, 4-pin, straight, A-coded • Connection type head B: Flying leads • Signal type: Sensor/actuator cable • Cable: 5 m, 4-wire, PVC • Description: Sensor/actuator cable, unshielded • Application: Zones with chemicals 	YF8U14-050VA3XLEAX	2095889

	Brief description	Type	Part no.
	<ul style="list-style-type: none"> • Connection type head A: Male connector, M8, 4-pin, straight • Description: Unshielded • Connection systems: Screw-type terminals • Permitted cross-section: 0.14 mm² ... 0.5 mm² 	STE-0804-G	6037323

Recommended services

Additional services → www.sick.com/W4

	Type	Part no.
<p>Function Block Factory</p> <ul style="list-style-type: none"> • Description: The Function Block Factory supports common programmable logic controllers (PLCs) from various manufacturers, such as Siemens, Beckhoff, Rockwell Automation and B&R. More information on the FBF can be found <a _blank"="" href="https://fbf.cloud.sick.com target=">here. • Note: You can configure your function block at <a _blank"="" href="https://fbf.cloud.sick.com target=">Function Block Factory. As a login please use your SICK ID. 	Function Block Factory	On request

SICK AT A GLANCE

SICK is one of the leading manufacturers of intelligent sensors and sensor solutions for industrial applications. A unique range of products and services creates the perfect basis for controlling processes securely and efficiently, protecting individuals from accidents and preventing damage to the environment.

We have extensive experience in a wide range of industries and understand their processes and requirements. With intelligent sensors, we can deliver exactly what our customers need. In application centers in Europe, Asia and North America, system solutions are tested and optimized in accordance with customer specifications. All this makes us a reliable supplier and development partner.

Comprehensive services complete our offering: SICK LifeTime Services provide support throughout the machine life cycle and ensure safety and productivity.

For us, that is “Sensor Intelligence.”

WORLDWIDE PRESENCE:

Contacts and other locations –www.sick.com