

# High Isolation Power Transformers

EP7 Platform SMD - PAG6356.XXXNLT Series



- ④ 10W Push Pull Transformer
- ④ Designed for TI's Sn6505x and 1-2 MHz switching frequency
- ④ Reinforced insulation for isolated power supply driver
- ④ 8mm creepage and clearance
- ④ 5KVrms isolation (Up to 1000Vpk rated voltage)

## Electrical Specifications @ 25°C - Operating Temperature -40°C to +125°C

Part Number	Inductance (1-3) (μH min)	Leakage Inductance (μH MAX)	DCR (1-3) (Ω MAX)	DCR (4-6) (Ω MAX)	ET MAX (1-3) <sup>1</sup> (V-μsec MAX)	CAP (pF MAX)	Turns Ratio (1-3):(6-4)	Isolated Voltage (Vrms)
PAG6356.081NLT	200	6.0	0.56	0.12	21	4	8CT : 1CT	5000
PAG6356.082NLT		2.3		0.18		6	8CT : 2CT	
PAG6356.085NLT		0.9		0.36		9	8CT : 5CT	
PAG6356.086NLT		0.8		0.40		10	8CT : 6CT	

### Notes:

1. The ET Max is calculated to limit the core loss and temperature rise at 1MHz based on a bipolar flux swing of 61mT Peak.
2. For Push-Pull topology, where the voltage is applied across half the primary winding turns, the ET needs to be derated by 50% for the same flux swing.
3. The applied ET may need to be further derated for higher frequencies based on the temperature rise which results from the core and copper losses
  - A. To calculate total copper loss (W), use the following formula:  
Copper Loss (W) =  $I_{rms\_Primary}^2 * DCR\_Primary + I_{rms\_Secondary}^2 * DCR\_Secondary$
  - B. To calculate total core loss (W), use the following formula:  
Core Loss (W) =  $5.42E-11 * (Frequency \text{ in kHz})^{2.0325} * (61 * [ET/ET \text{ Max}])^{2.018}$
4. Creepage and clearance is in accordance with IEC 61558-1 for reinforced insulation to a working voltage of 400Vrms (for basic insulation to a working voltage of 800Vrms) based on material group III, pollution degree 2, OVC II and 5000m altitude.
5. Rated voltage is based on a positive partial discharge test (discharge < 10pC) for the profile shown in page 3, in accordance with IEC60664 for basic insulation. In an application which requires a reinforced insulation barrier, a rated voltage of the equivalent peak working voltage, 880Vpk, is defined and confirmed by partial discharge testing.

## Mechanical

## Schematic

### PAG6356.XXXNLT

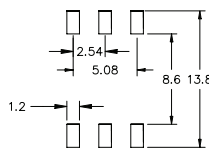

SUGGESTED LAND PATTERN

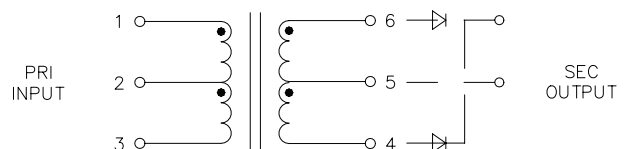

SCHEMATIC

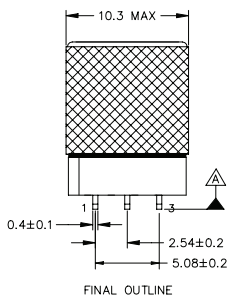

FINAL OUTLINE

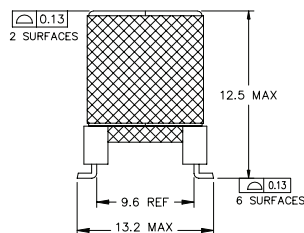

Weight .....2.6grams  
Tape & Reel .....150/reel  
Tray .....80/tray

Dimensions:  $\frac{\text{Inches}}{\text{mm}}$

unless otherwise specified,  
all tolerances are  $\pm \frac{.010}{0.25}$

# High Isolation Power Transformers

EP7 Platform SMD - PAG6356.XXXNLT Series

## TAPE & REEL INFO

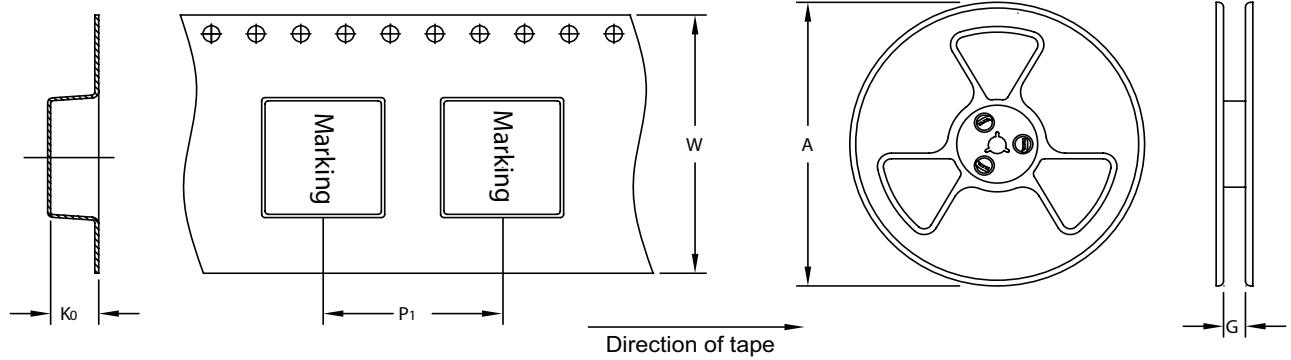

### SURFACE MOUNTING TYPE, REEL/TAPE LIST

PART NUMBER	REEL SIZE (mm)		TAPE SIZE (mm)			QTY
	A	G	P <sub>1</sub>	W	K <sub>0</sub>	PCS/REEL
PAG6356.XXXNLT	Ø330	32.4	24	32	12.8	150

## APPLICATION

PAG6356.XXXNLT is a series of high isolation transformers. Designed for the TI's Sn6505x high frequency, fixed duty cycle push pull driver, it is a part of a low cost solution for delivering up to 10W of power from a 24V source. Different turns ratios are available to deliver from 3.3V to 15V output.

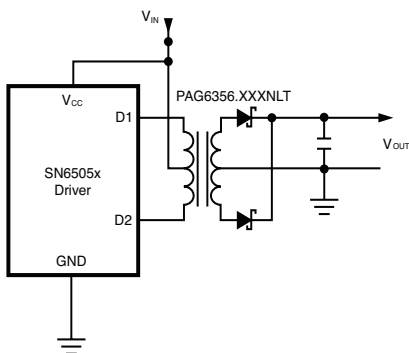

PART NUMBER	Primary Input	Secondary Output
PAG6356.081NLT	24V	3.3V/3A
PAG6356.082NLT	24V	5V/2A
PAG6356.085NLT	24V	12V/0.8A
PAG6356.086NLT	24V	15V/0.67A

This transformer design complies with IEC61558-1 and IEC62368-1, with reinforced insulation for a working voltage up to 400Vac. The 8mm creepage and clearance distance and 5000Vrms isolation voltage guarantees these requirements. The design also complies with the Pulse's class F insulation system.

# High Isolation Power Transformers

EP7 Platform SMD - PAG6356.XXXNLT

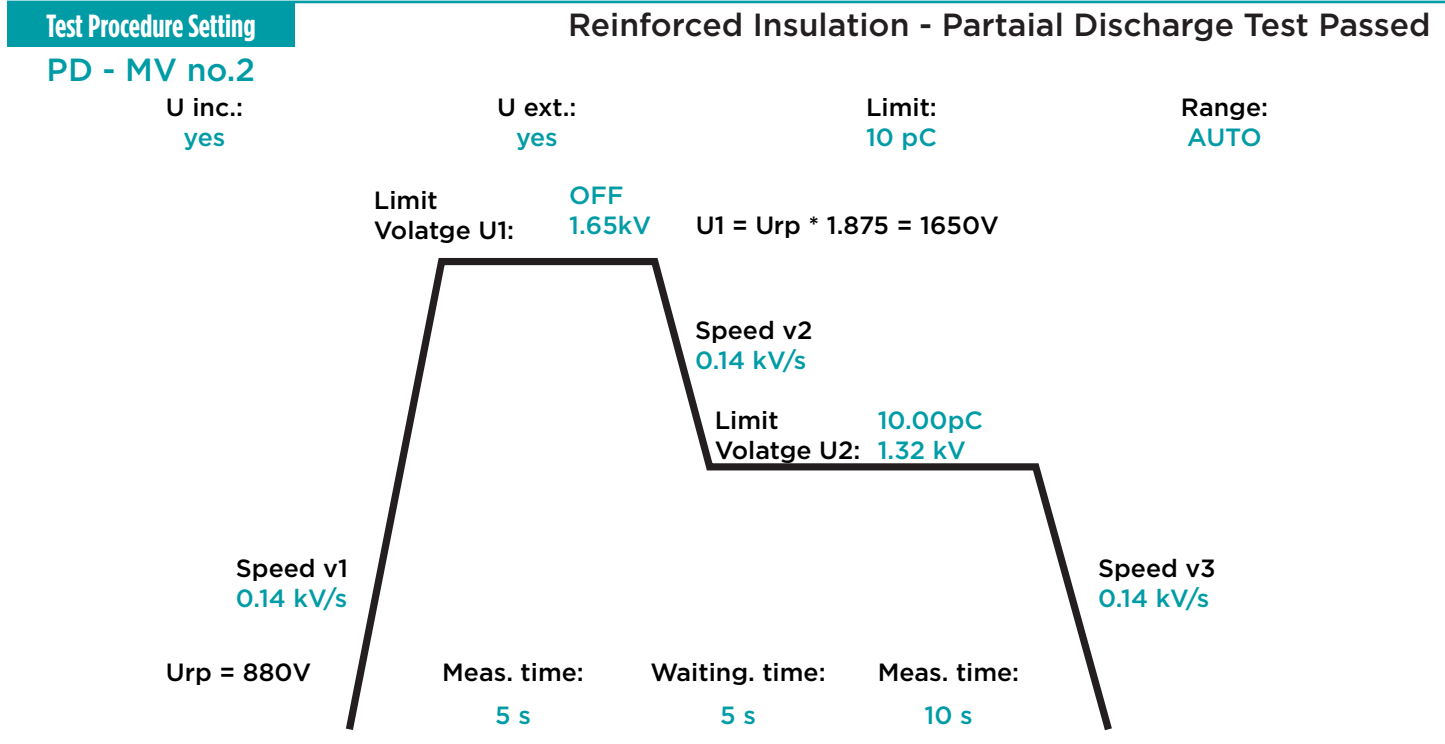
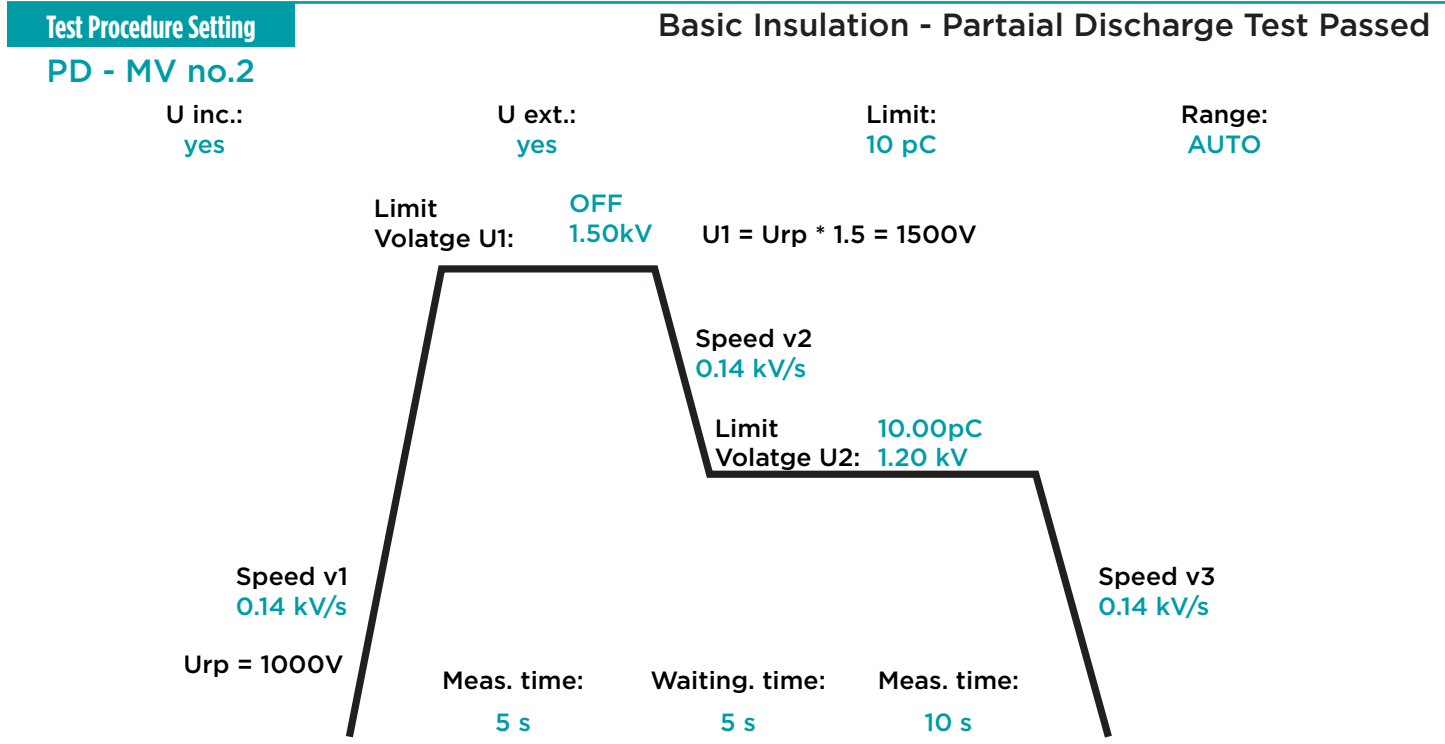

**For More Information:**

Americas - [prodinfo\\_power\\_americas@yageo.com](mailto:prodinfo_power_americas@yageo.com) | Europe - [prodinfo\\_power\\_emea@yageo.com](mailto:prodinfo_power_emea@yageo.com) | Asia - [prodinfo\\_power\\_asia@yageo.com](mailto:prodinfo_power_asia@yageo.com)

Performance warranty of products offered on this data sheet is limited to the parameters specified. Data is subject to change without notice. Other brand and product names mentioned herein may be trademarks or registered trademarks of their respective owners. © Copyright, 2023. Pulse Electronics, Inc. All rights reserved.

YAGEO Corporation and its affiliates do not recommend the use of commercial or automotive grade products for high reliability applications or manned space flight.