

# R75, Single Metallized Polypropylene Film, Radial, DC and Pulse Applications (Automotive Grade)

## Overview

The R75 series is constructed of metallized polypropylene film with radial leads of tinned wire. The radial leads are electrically welded to the metal layer on the ends of the capacitor winding. The capacitor is encapsulated in a self-extinguishing solvent resistant plastic case with thermosetting resin material meeting the UL 94 V-0 requirements. Different winding constructions are used depending on voltage parameters and lead spacing. Please see the Performance Characteristics for more information.

Automotive grade devices (lead spacing 7.5 – 22.5 mm) meet the demanding Automotive Electronics Council's AEC-Q200 qualification requirements.

## Applications

Typical applications include resonant circuit, high frequency medium to high current, silicon-controlled rectifier (SCR and IGBT) and SiC (e.g. MOSFET) commutation circuits as well as applications with high voltage and medium to high current and DC link, timing, oscillator circuits, high frequency coupling and decoupling applications.

Not suitable for across-the-line application (see Suppressor Capacitors).

## Benefits

- Voltage range: 160 – 2,000 VDC
- Capacitance range: 220 pF – 33  $\mu$ F
- Lead Spacing: 5 – 37.5 mm
- Capacitance tolerance:  $\pm$ 5%,  $\pm$ 10%,  $\pm$ 20%
- Climatic category: 55/105/56 IEC 60068-1
- Operating temperature range of  $-55^{\circ}\text{C}$  to  $+105^{\circ}\text{C}$
- RoHS compliance and lead-free terminations
- Tape & Reel packaging in accordance with IEC 60286-2
- Self-healing
- Automotive (AEC-Q200) grade from lead spacing 7.5 – 22.5 mm

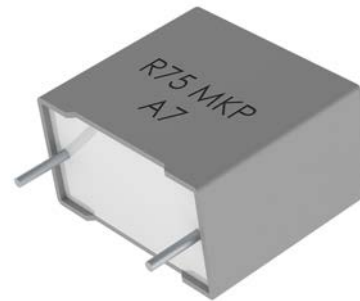

## Part Number System

R75	P	N	2820	AA	30	K	
Series	Rated Voltage (VDC)	Lead Spacing (mm)	Capacitance Code (pF)	Packaging	Internal Use		Capacitance Tolerance
Metallized Polypropylene	G = 160 I = 250 M = 400 P = 630 Q = 1,000 R = 1,250 J = 1,300 T = 1,600 U = 2,000	C = 5 D = 7.5 F = 10 I = 15 N = 22.5 R = 27.5 W = 37.5	The last three digits represent significant figures. The first digit specifies the total number of zeros to be added.	See Ordering Options Table	00 10 20 30 40 45	50 60 70 80 L0	H = $\pm$ 2.5% J = $\pm$ 5% K = $\pm$ 10% M = $\pm$ 20%

Halogen free is available upon special request.

Built Into Tomorrow

## Ordering Options Table

Lead Spacing Nominal (mm)	Type of Leads and Packaging	Lead Length (mm)	Lead and Packaging Code
5	<b>Standard Lead and Packaging Options</b>		
	Bulk (Bag) – Short Leads	4 +1.5/-0	AA
	Ammo Pack	H <sub>0</sub> = 18.5±0.5	DQ
	<b>Other Lead and Packaging Options</b>		
	Tape & Reel (Standard Reel Ø 355 mm)	H <sub>0</sub> = 18.5±0.5	CK
	Bulk – Short Leads	10±1	JC
	Bulk – Short Leads	4.0 +0.5/-0	JE
	Bulk – Short Leads	3.2 +0.3/-0.2	JH
Bulk – Long Leads	17 +1/-2	Z3	
7.5	<b>Standard Lead and Packaging Options</b>		
	Bulk – Short Leads	4 +2/-0	AA
	Ammo Pack	H <sub>0</sub> = 18.5±0.5	DQ
	<b>Other Lead and Packaging Options</b>		
	Tape & Reel (Standard Reel Ø 355 mm)	H <sub>0</sub> = 18.5±0.5	CK
	Bulk – Short Leads	2.7 +0.5/-0	JA
	Bulk – Short Leads	3.5 +0.5/-0	JB
	Bulk – Short Leads	4.0 +0.5/-0	JE
	Bulk – Short Leads	3.2 +0.3/-0.2	JH
	Bulk – Long Leads	18±1	JM
Bulk – Long Leads	17 +1/-2	Z3	
10 15 22.5	<b>Standard Lead and Packaging Options</b>		
	Bulk (Bag) – Short Leads	4 +2/-0	AA
	Ammo Pack	H <sub>0</sub> = 18.5±0.5	DQ
	<b>Other Lead and Packaging Options</b>		
	Tape & Reel (Standard Reel Ø 355 mm)	H <sub>0</sub> = 18.5±0.5	GY
	Tape & Reel (Large Reel Ø 500 mm)	H <sub>0</sub> = 18.5±0.5	CK
	Bulk (Bag) – Short Leads	2.7 +0.5/-0	JA
	Bulk (Bag) – Short Leads	3.5 +0.5/-0	JB
	Bulk (Bag) – Short Leads	10±1	JC
	Bulk (Bag) – Short Leads	4.0 +0.5/-0	JE
	Bulk (Bag) – Short Leads	3.2 +0.3/-0.2	JH
	Bulk (Bag) – Long Leads	18±1	JM
	Bulk (Bag) – Long Leads	30 +5/-0	40
	Bulk (Bag) – Long Leads	25 +2/-1	50

## Ordering Options Table cont.

Lead Spacing Nominal (mm)	Type of Leads and Packaging	Lead Length (mm)	Lead and Packaging Code
27.5	<b>Standard Lead and Packaging Options</b>		
	Bulk (Tray) – Short Leads	4 +2/-0	AA
	<b>Other Lead and Packaging Options</b>		
	Tape & Reel (Standard Reel Ø 355 mm)	$H_0 = 18.5 \pm 0.5$	GY
	Tape & Reel (Large Reel Ø 500 mm)	$H_0 = 18.5 \pm 0.5$	CK <sup>1</sup>
	Bulk (Tray) – Short Leads	3.5 +0.5/-0	JB
	Bulk (Tray) – Short Leads	4.0 +0.5/-0	JE
	Bulk (Tray) – Short Leads	3.2 +0.3/-0.2	JH
	Bulk (Tray) – Long Leads	30 +5/-0	40
Bulk (Tray) – Long Leads	25 +2/-1	50	
37.5	<b>Standard Lead and Packaging Options</b>		
	Bulk (Tray) – Short Leads	4 +2/-0	AA
	<b>Other Lead and Packaging Options</b>		
	Bulk (Tray) – Short Leads	3.5 +0.5/-0	JB
	Bulk (Tray) – Short Leads	4.0 +0.5/-0	JE
	Bulk (Tray) – Short Leads	3.2 +0.3/-0.2	JH
	Bulk (Tray) – Long Leads	30 +5/-0	40
	Bulk (Tray) – Long Leads	25 +2/-1	50

<sup>1</sup> = Not for all sizes, see "Packaging Quantities" table.

## Dimensions – Millimeters

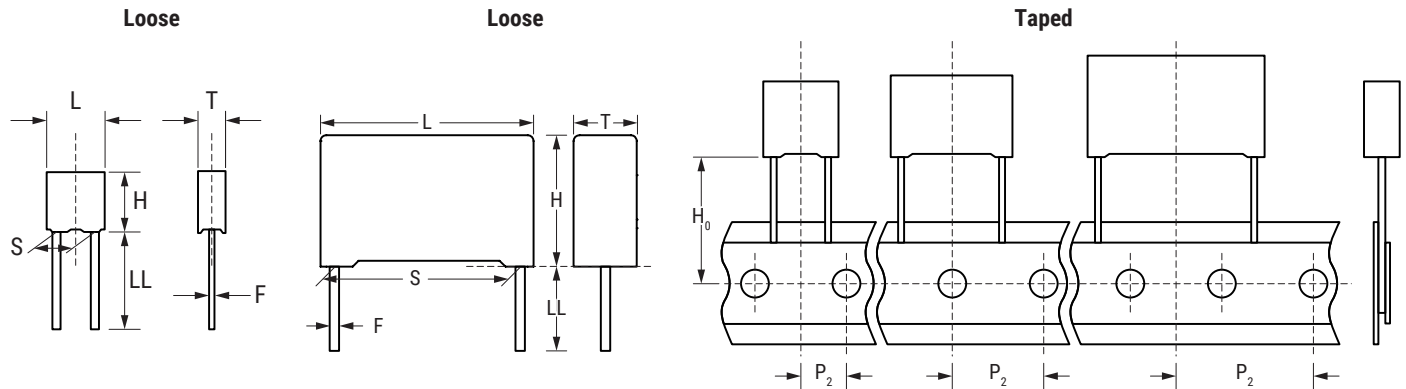

S		T		H		L		F	
Nominal	Tolerance	Nominal	Tolerance	Nominal	Tolerance	Nominal	Tolerance	Nominal	Tolerance
5.0	±0.4	3.5	+0.1/-0.5	7.5	+0.1/-0.5	7.2	+0.2/-0.5	0.5	±0.05
5.0	±0.4	4.5	+0.1/-0.5	9.5	+0.1/-0.5	7.2	+0.3/-0.5	0.5	±0.05
5.0	±0.4	5.0	+0.1/-0.5	10.0	+0.1/-0.5	7.2	+0.3/-0.5	0.5	±0.05
5.0	±0.4	6.0	+0.1/-0.5	11.0	+0.1/-0.5	7.2	+0.3/-0.5	0.5	±0.05
5.0	±0.4	7.2	+0.1/-0.5	13.0	+0.1/-0.5	7.2	+0.3/-0.5	0.5	±0.05
7.5	±0.4	3.0	+0.1/-0.5	8.0	+0.1/-0.5	10.0	+0.2/-0.5	0.5	±0.05
7.5	±0.4	4.0	+0.1/-0.5	9.0	+0.1/-0.5	10.0	+0.2/-0.5	0.5	±0.05
7.5	±0.4	5.0	+0.1/-0.5	10.5	+0.1/-0.5	10.0	+0.2/-0.5	0.5	±0.05
7.5	±0.4	6.0	+0.1/-0.5	12.0	+0.1/-0.5	10.5	+0.2/-0.5	0.5	±0.05
10.0	±0.4	4.0	+0.2/-0.5	9.0	+0.1/-0.5	13.0	+0.2/-0.5	0.6	±0.05
10.0	±0.4	5.0	+0.2/-0.5	11.0	+0.1/-0.5	13.0	+0.2/-0.5	0.6	±0.05
10.0	±0.4	6.0	+0.2/-0.5	12.0	+0.1/-0.5	13.0	+0.2/-0.5	0.6	±0.05
15.0	±0.4	4.0	+0.2/-0.5	10.0	+0.1/-0.5	18.0	+0.3/-0.5	0.8	±0.05
15.0	±0.4	5.0	+0.2/-0.5	11.0	+0.1/-0.5	18.0	+0.3/-0.5	0.8	±0.05
15.0	±0.4	6.0	+0.2/-0.5	12.0	+0.1/-0.5	18.0	+0.3/-0.5	0.8	±0.05
15.0	±0.4	7.5	+0.2/-0.5	13.5	+0.1/-0.5	18.0	+0.5/-0.5	0.8	±0.05
15.0	±0.4	8.5	+0.2/-0.5	14.5	+0.1/-0.5	18.0	+0.5/-0.5	0.8	±0.05
15.0	±0.4	9.0	+0.2/-0.5	12.5	+0.1/-0.5	18.0	+0.5/-0.5	0.8	±0.05
15.0	±0.4	10.0	+0.2/-0.5	16.0	+0.1/-0.5	18.0	+0.5/-0.5	0.8	±0.05
15.0	±0.4	11.0	+0.2/-0.5	19.0	+0.1/-0.5	18.0	+0.5/-0.5	0.8	±0.05
15.0	±0.4	13.0	+0.1/-0.5	12.0	+0.1/-0.5	18.0	+0.5/-0.5	0.8	±0.05

Note: See Ordering Options Table for lead length (LL/Ho) options.

## Dimensions – Millimeters cont.

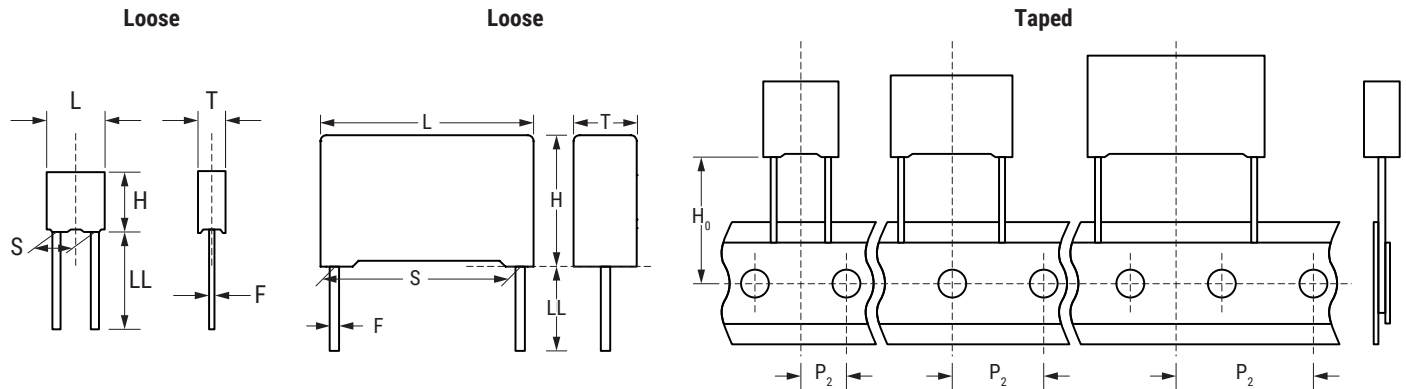

S		T		H		L		F	
Nominal	Tolerance	Nominal	Tolerance	Nominal	Tolerance	Nominal	Tolerance	Nominal	Tolerance
22.5	±0.4	6.0	+0.2/-0.5	15.0	+0.1/-0.5	26.5	+0.3/-0.5	0.8	±0.05
22.5	±0.4	7.0	+0.2/-0.5	16.0	+0.1/-0.5	26.5	+0.3/-0.5	0.8	±0.05
22.5	±0.4	8.5	+0.2/-0.5	17.0	+0.1/-0.5	26.5	+0.3/-0.5	0.8	±0.05
22.5	±0.4	10.0	+0.2/-0.5	18.5	+0.1/-0.5	26.5	+0.3/-0.5	0.8	±0.05
22.5	±0.4	11.0	+0.2/-0.5	20.0	+0.1/-0.5	26.5	+0.3/-0.5	0.8	±0.05
22.5	±0.4	13.0	+0.2/-0.5	22.0	+0.1/-0.5	26.5	+0.3/-0.5	0.8	±0.05
22.5	±0.4	14.5	+0.2/-0.5	29.5	+0.1/-0.5	26.5	+0.3/-0.5	0.8	±0.05
27.5	±0.4	9.0	+0.2/-0.7	17.0	+0.1/-0.7	32.0	+0.3/-0.7	0.8	±0.05
27.5	±0.4	11.0	+0.2/-0.7	20.0	+0.1/-0.7	32.0	+0.3/-0.7	0.8	±0.05
27.5	±0.4	13.0	+0.2/-0.7	22.0	+0.1/-0.7	32.0	+0.3/-0.7	0.8	±0.05
27.5	±0.4	13.0	+0.2/-0.7	25.0	+0.1/-0.7	32.0	+0.3/-0.7	0.8	±0.05
27.5	±0.4	14.0	+0.2/-0.7	28.0	+0.1/-0.7	32.0	+0.3/-0.7	0.8	±0.05
27.5	±0.4	18.0	+0.2/-0.7	33.0	+0.1/-0.7	32.0	+0.3/-0.7	0.8	±0.05
27.5	±0.4	21.0	+0.2/-0.7	12.5	+0.1/-0.7	32.0	+0.3/-0.7	0.8	±0.05
27.5	±0.4	22.0	+0.2/-0.7	37.0	+0.1/-0.7	32.0	+0.3/-0.7	0.8	±0.05
27.5	±0.4	24.0	+0.2/-0.7	15.0	+0.1/-0.7	32.0	+0.3/-0.7	0.8	±0.05
37.5	±0.4	11.0	+0.3/-0.7	22.0	+0.1/-0.7	41.5	+0.3/-0.7	1.0	±0.05
37.5	±0.4	13.0	+0.3/-0.7	24.0	+0.1/-0.7	41.5	+0.3/-0.7	1.0	±0.05
37.5	±0.4	16.0	+0.3/-0.7	28.5	+0.1/-0.7	41.5	+0.3/-0.7	1.0	±0.05
37.5	±0.4	19.0	+0.3/-0.7	32.0	+0.1/-0.7	41.5	+0.3/-0.7	1.0	±0.05
37.5	±0.4	20.0	+0.3/-0.7	40.0	+0.1/-0.7	41.5	+0.3/-0.7	1.0	±0.05
37.5	±0.4	24.0	+0.3/-0.7	44.0	+0.1/-0.7	41.5	+0.3/-0.7	1.0	±0.05
37.5	±0.4	24.0	+0.3/-0.7	15.0	+0.1/-0.7	41.5	+0.3/-0.7	1.0	±0.05
37.5	±0.4	24.0	+0.3/-0.7	19.0	+0.1/-0.7	41.5	+0.3/-0.7	1.0	±0.05
37.5	±0.4	30.0	+0.3/-0.7	45.0	+0.1/-0.7	41.5	+0.3/-0.7	1.0	±0.05

**Note: See Ordering Options Table for lead length (LL/Ho) options.**

## Performance Characteristics

Dielectric	Polypropylene film													
Plates	Metal layer deposited by evaporation under vacuum													
Winding	Non-inductive type													
Leads	Tinned wire													
Protection	Plastic case, thermosetting resin filled. Box material is solvent resistant and flame retardant according to UL94.													
Related Documents	IEC 60384-16													
Sections	1									2	3			
Rated Voltage $V_R$ (VDC)	160	160	250	250	400	400	630	630	1,000	1,300	1,000	1,250	1,600	2,000
Rated Voltage $V_R$ (VAC)	70	90	140	160	200	220	220	250	300	400	400	450/600	650	700
Capacitance Range ( $\mu$ F)	0.039 -0.33	0.068 -33	0.068 -0.22	0.012 -33	0.0039 -0.068	0.01 -15	0.001 -0.027	0.001 -8.2	0.0056 -3.9	0.0068 -3.3	0.00022 -0.0082	0.0082 -2.2	0.0039 -1.5	0.001 -1
Capacitance Values	E12 series (IEC 60063) measured at 1 kHz and +20 $\pm$ 1°C													
Capacitance Tolerance	$\pm$ 2.5%, $\pm$ 5%, $\pm$ 10%, $\pm$ 20%													
Operating Temperature Range	-55°C to +105°C													
Rated Temperature $T_R$	+85°C													
Voltage Derating	Above +85°C DC voltage derating is 2%/°C (1.25%/°C for lead spacing 5 mm) and AC voltage derating is 1.25%/°C													
Climatic Category	55/105/56 IEC 60068-1													
Storage Conditions	Storage time: $\leq$ 24 months from the date marked on the label package													
	Average relative humidity per year $\leq$ 70%													
	RH $\leq$ 85% for 30 days randomly distributed throughout the year													
	Dew is absent													
	Temperature: -40 to 80°C (see "Maximum Humidity in Storage Conditions" graph above)													
Test Voltage	1.6 x $V_R$ VDC for 2 seconds (between terminations) at +25°C $\pm$ 5°C													
Capacitance Drift	Maximum 0.5% after a 2 year storage period at a temperature of +10°C to +40°C and a relative humidity of 40% to 60%													
Maximum Pulse Steepness	dV/dt according to Table 1. For working voltages lower than rated voltage ( $V < V_R$ ), the specified dV/dt can be multiplied by the factor $V_R/V$ .													
Reliability (Reference IEC 61709)	Operational life > 200,000 hours at 85°C Failure rate $\leq$ 1 FIT, $T = +40^\circ\text{C}$ , $V = 0.5 \times V_R$ Failure criteria: open or short circuit, capacitance change > 10%, DF 2 times the catalog limits, IR < 0.005 x initial limit													
Temperature Coefficient	-(200 $\pm$ 100) ppm/°C at 1 kHz													
Self Inductance (Lead Length ~ 2 mm)	Lead Spacing (mm)	5	7.5	10	15	22.5	27.5	37.5						
	L (nH) $\approx$	7	8	9	10	16	18	20						
	Maximum 1 nH per 1 mm lead and capacitor length.													

## Performance Characteristics cont.

Dissipation Factor $\tan\delta$	Maximum Values at 25°C ±5°C						
	Frequency	C ≤ 0.1 μF	C ≤ 0.1 μF (lead spacing 5 mm)	C > 0.1 μF (lead spacing 5 mm)	0.1 μF < C ≤ 1.0 μF	1.0 μF < C ≤ 4.7 μF	C > 4.7 μF
	1 kHz	0.04%	0.06%	0.06%	0.05%	0.06%	0.10%
10 kHz	0.06%	0.10%	0.10%	0.08%	-	-	
100 kHz	0.25%	0.30%	-	-	-	-	

Insulation Resistance	Measured at +25°C ±5°C, 100 VDC 60 seconds	
	Minimum Values Between Terminals	
	C ≤ 0.33 μF	C > 0.33 μF
	≥ 100,000 MΩ (≥ 500,000 MΩ)*	≥ 30,000 MΩ · μF (≥ 150,000 MΩ · μF)*

\* Typical value

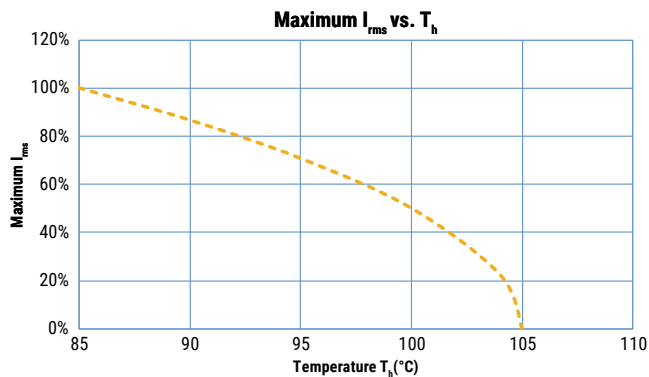
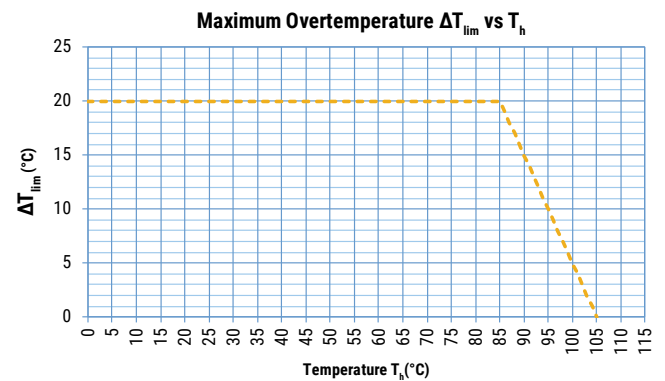
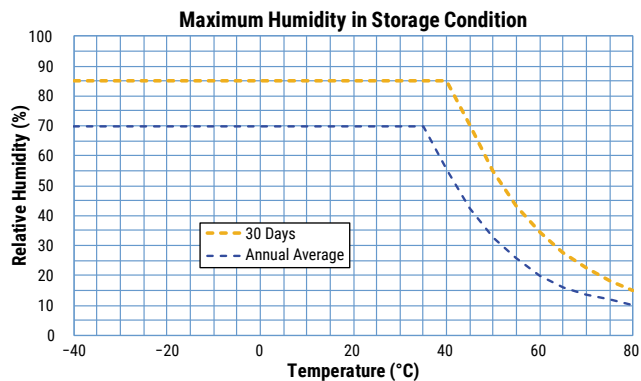

$T_h$  is the maximum ambient temperature surrounding the capacitor or hottest contact point (e.g. tracks), whichever is higher, in the worst operation conditions in °C.

## Qualification

Automotive Grade products meet or exceed the requirements outlined by the Automotive Electronics Council. Details regarding test methods and conditions are referenced in document AEC-Q200, Stress Test Qualification for Passive Components. For additional information regarding the Automotive Electronics Council and AEC-Q200, please visit their website at [www.aecouncil.com](http://www.aecouncil.com).

## Maximum Voltage ( $V_{rms}$ ) vs. Frequency (Sinusoidal Waveform/ $Th \leq 85^\circ C$ )

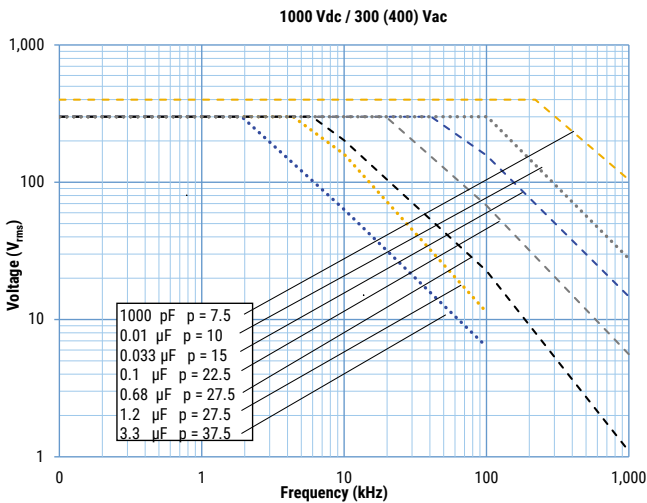
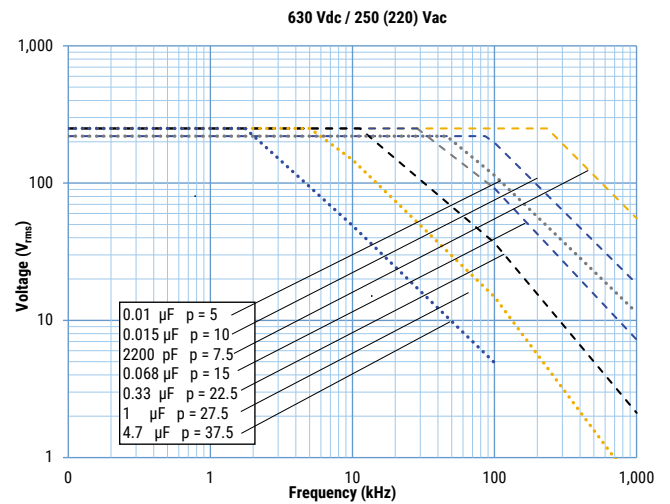
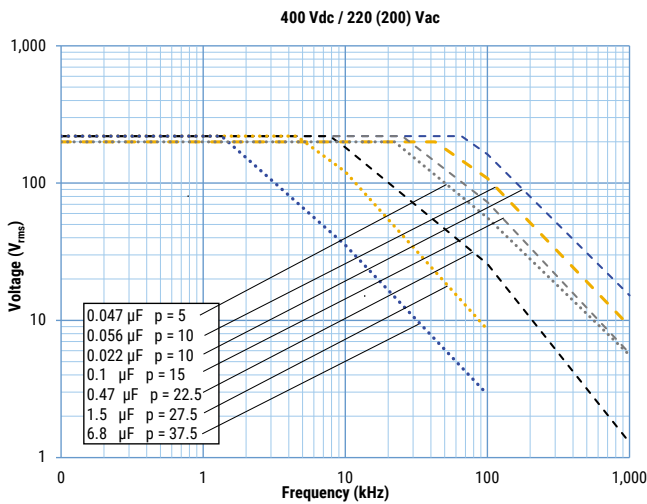
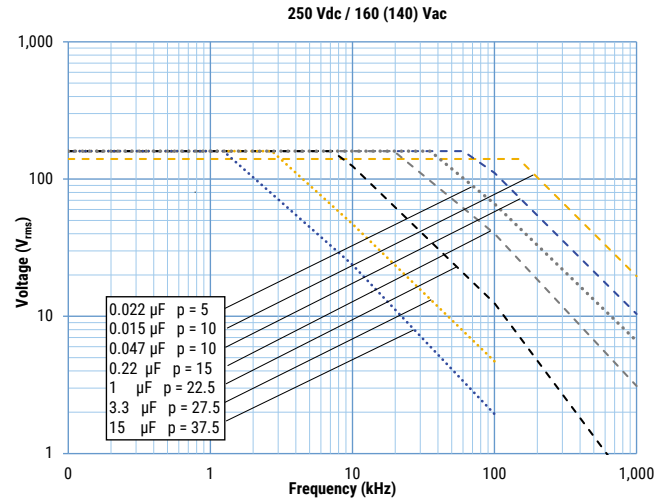
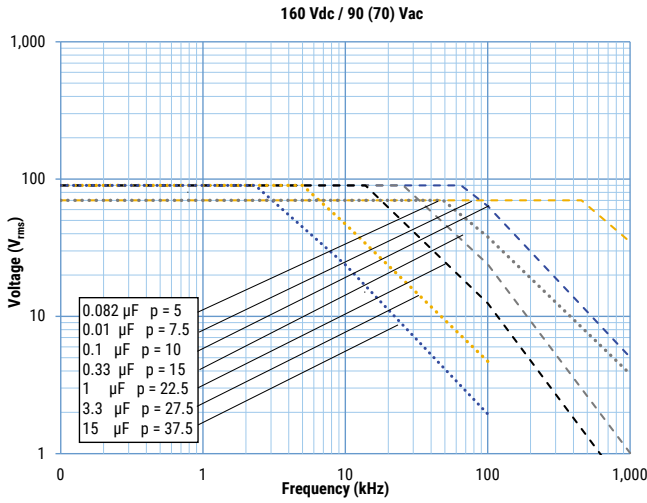

## Maximum Voltage ( $V_{rms}$ ) vs. Frequency (Sinusoidal Waveform/ $Th \leq 85^\circ C$ ) cont.

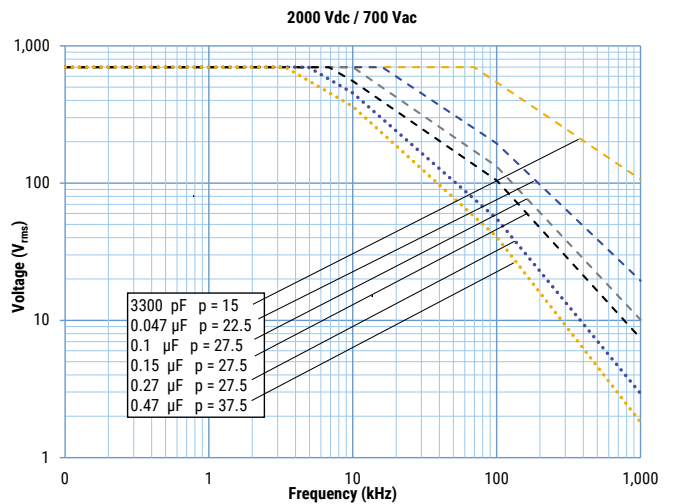
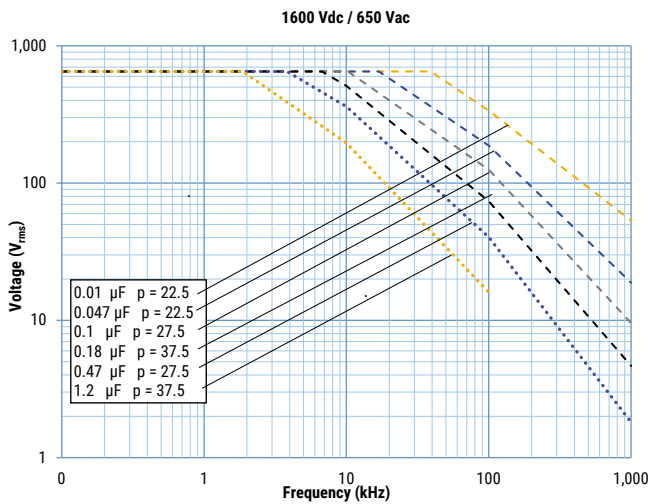
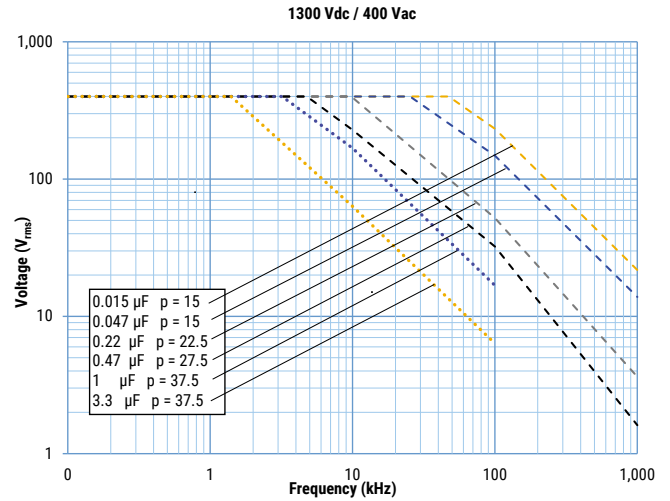
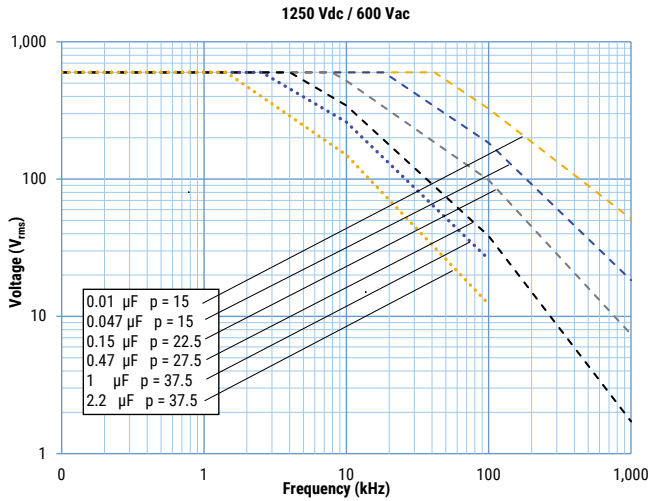

## Maximum Current ( $I_{rms}$ ) vs. Frequency (Sinusoidal Waveform/ $T_h \leq 85^\circ\text{C}$ )

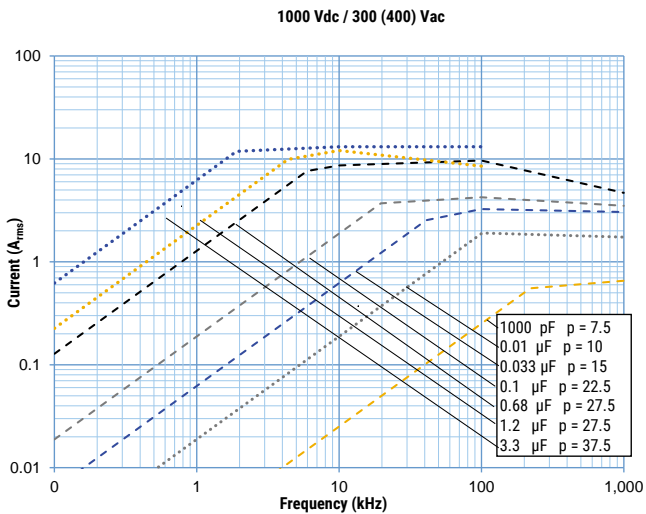
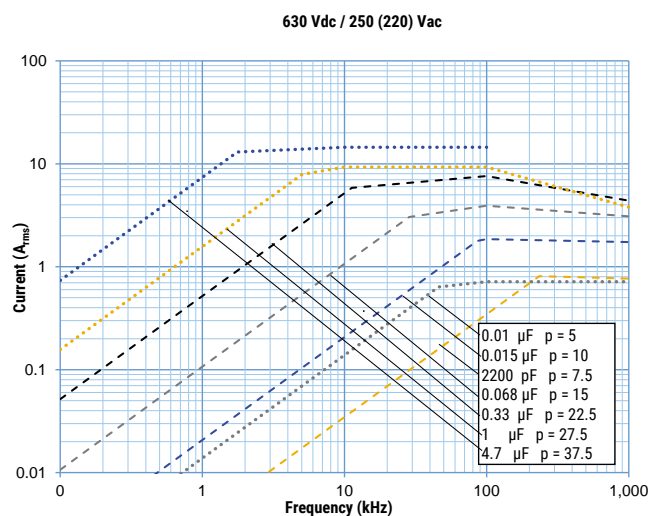
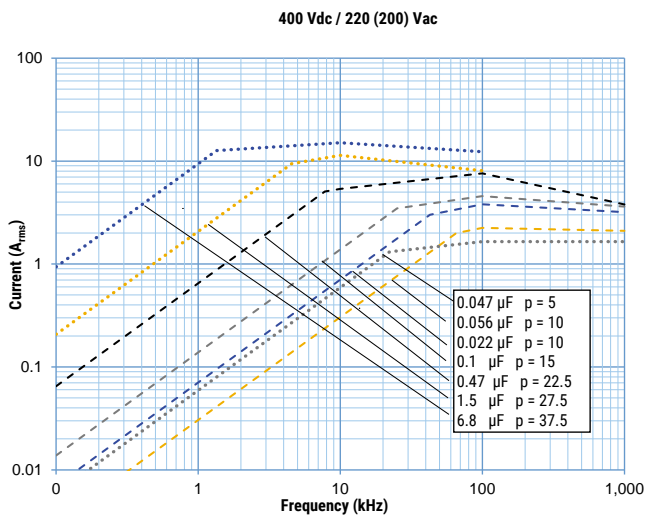
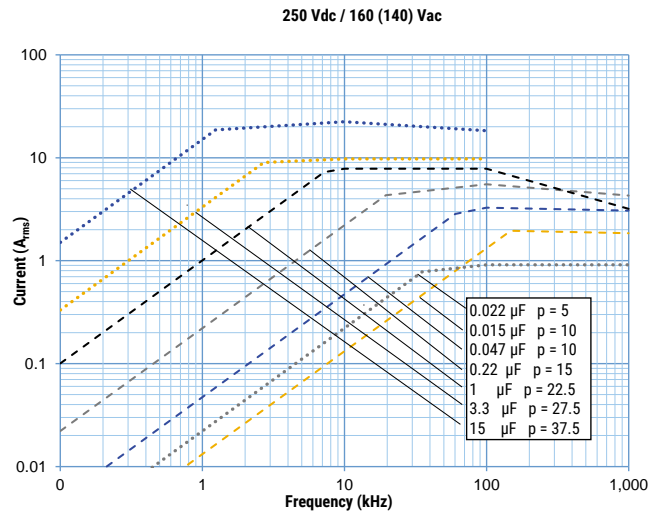
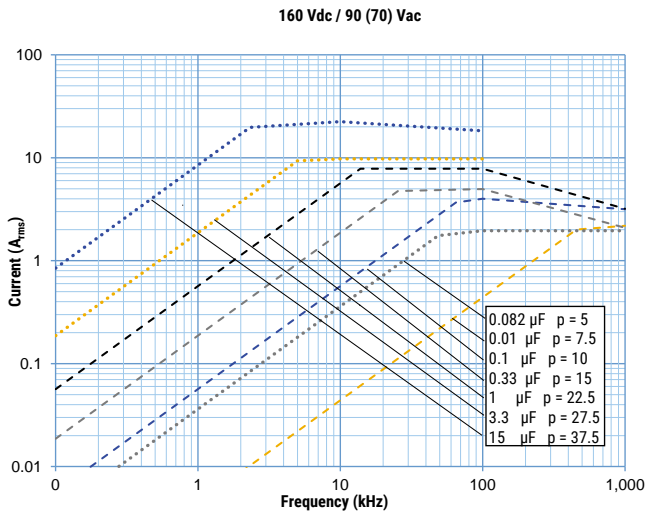

## Maximum Current ( $I_{rms}$ ) vs. Frequency (Sinusoidal Waveform/ $T_h \leq 85^\circ\text{C}$ ) cont.

1250 Vdc / 600 Vac

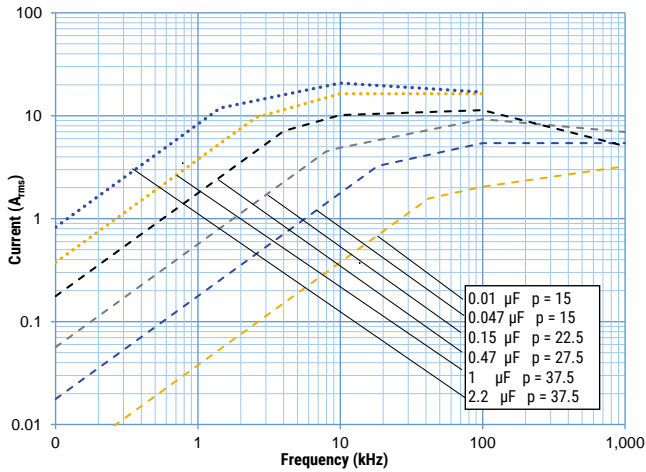

1300 Vdc / 400 Vac

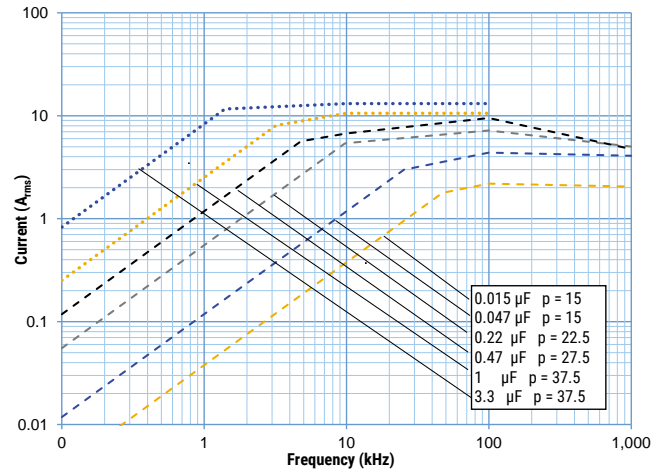

1600 Vdc / 650 Vac

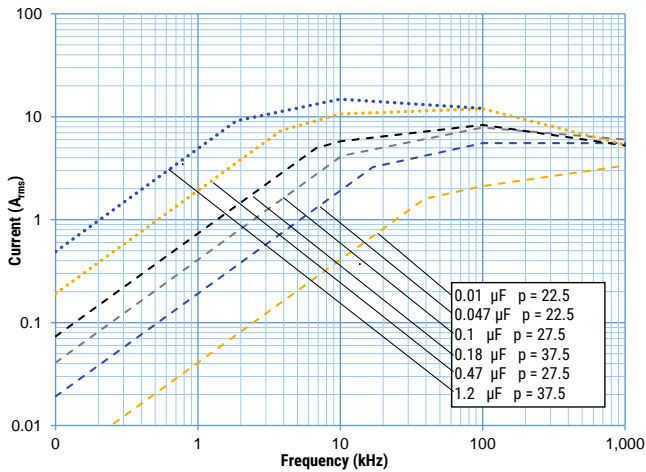

2000 Vdc / 700 Vac

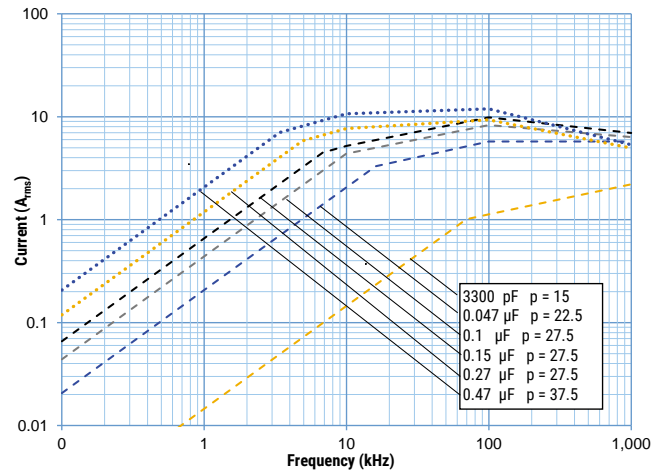

## Environmental Test Data

Damp Heat, Steady State Test	Test Conditions:		Performances
	Temperature: Relative humidity (RH): Test duration:	+40°C ±2°C 93% ±2% 56 days	Δ C/C   ≤ 2%,   Δ C/C   ≤ 3% (lead spacing 5 mm), Δ tanδ ≤ 0.001 at 1 kHz IR after test ≥ 50% of initial limit
Endurance Test	Test Conditions		Performances
	Temperature: Voltage applied: Test duration:	+85°C ±2°C 1.25 x V <sub>R</sub> (DC) 2,000 hours 1,000 hours (lead spacing 5 mm)	Δ C/C   ≤ 3%, Δ tanδ ≤ 0.001 at 10 kHz for C ≤ 1 μF Δ tanδ ≤ 0.001 at 1 kHz for C > 1 μF IR after test ≥ 50% of initial limit
Resistance to Soldering Heat Test	Test Conditions		Performances
	Solder bath temperature: Dipping time (with heat screen):	260°C ±5°C 10 seconds ±1 second	Δ C/C   ≤ 1%,   Δ C/C   ≤ 2% (lead spacing 5 mm), Δ tanδ ≤ 0.001 at 10 kHz for C ≤ 1 μF Δ tanδ ≤ 0.001 at 1 kHz for C > 1 μF IR after test ≥ initial limit

## Environmental Compliance

All KEMET pulse capacitors are RoHS Compliant.



**Table 1 – Ratings & Part Number Reference**

VDC	VAC	Cap Value (µF)	Dimensions in mm			Lead Spacing (S)	dV/dt (V/µs)	Max K <sub>0</sub> (V <sup>2</sup> /µs)	I <sub>pk</sub>	ESL	ESR max	I <sub>rms</sub> max (*)		R <sub>th</sub>	KEMET Internal Part Number	Customer Part Number
										Lead Length 2x 4 mm	at 100 kHz	at 100 kHz, 85°C	A <sub>rms</sub>			
			A <sub>pk</sub>	nH	mΩ					(°C/W)						
160	70	0.039	3.5	7.5	7.2	5.0	100	32,000	4	7	122.4	1.21	111	75GC2390(1)40(4)	R75GC2390(1)40(4)	
160	70	0.047	4.5	9.5	7.2	5.0	100	32,000	5	7	101.6	1.44	94	75GC2470(1)40(4)	R75GC2470(1)40(4)	
160	70	0.056	4.5	9.5	7.2	5.0	100	32,000	6	7	85.3	1.58	94	75GC2560(1)40(4)	R75GC2560(1)40(4)	
160	70	0.068	4.5	9.5	7.2	5.0	100	32,000	7	7	70.2	1.74	94	75GC2680(1)40(4)	R75GC2680(1)40(4)	
160	70	0.082	5.0	10.0	7.2	5.0	100	32,000	8	7	58.2	1.96	90	75GC2820(1)40(4)	R75GC2820(1)40(4)	
160	70	0.1	5.0	10.0	7.2	5.0	100	32,000	10	7	47.7	2.16	90	75GC3100(1)40(4)	R75GC3100(1)40(4)	
160	70	0.12	6.0	11.0	7.2	5.0	100	32,000	12	7	39.8	2.48	82	75GC3120(1)40(4)	R75GC3120(1)40(4)	
160	70	0.15	6.0	11.0	7.2	5.0	100	32,000	15	7	31.8	2.77	82	75GC3150(1)40(4)	R75GC3150(1)40(4)	
160	70	0.18	7.2	13.0	7.2	5.0	100	32,000	18	7	44.2	2.50	73	75GC3180(1)40(4)	R75GC3180(1)40(4)	
160	70	0.22	7.2	13.0	7.2	5.0	100	32,000	22	7	36.2	2.76	73	75GC3220(1)40(4)	R75GC3220(1)40(4)	
160	70	0.1	4.0	9.0	10.0	7.5	100	32,000	10	8	11.1	4.40	88	75GD3100(1)B0(2)	R75GD3100(1)B0(2)	
160	70	0.12	5.0	10.5	10.0	7.5	100	32,000	12	8	9.3	5.25	78	75GD3120(1)B0(2)	R75GD3120(1)B0(2)	
160	70	0.15	5.0	10.5	10.0	7.5	100	32,000	15	8	7.4	5.87	78	75GD3150(1)B0(2)	R75GD3150(1)B0(2)	
160	70	0.18	6.0	12.0	10.5	7.5	100	32,000	18	8	10.6	5.21	69	75GD3180(1)A0(2)	R75GD3180(1)A0(2)	
160	70	0.22	6.0	12.0	10.5	7.5	100	32,000	22	8	8.7	5.76	69	75GD3220(1)A0(2)	R75GD3220(1)A0(2)	
160	70	0.12	4.0	9.0	13.0	10.0	90	28,800	11	9	13.3	4.38	79	75GF3120(1)A0(2)	R75GF3120(1)A0(2)	
160	70	0.15	4.0	9.0	13.0	10.0	90	28,800	14	9	10.6	4.90	79	75GF3150(1)A0(2)	R75GF3150(1)A0(2)	
160	70	0.18	5.0	11.0	13.0	10.0	90	28,800	16	9	13.3	4.67	69	75GF3180(1)A0(2)	R75GF3180(1)A0(2)	
160	70	0.22	5.0	11.0	13.0	10.0	90	28,800	20	9	10.9	5.17	69	75GF3220(1)A0(2)	R75GF3220(1)A0(2)	
160	70	0.27	6.0	12.0	13.0	10.0	90	28,800	24	9	17.7	4.21	64	75GF3270(1)A0(2)	R75GF3270(1)A0(2)	
160	70	0.33	6.0	12.0	13.0	10.0	90	28,800	30	9	14.5	4.65	64	75GF3330(1)A0(2)	R75GF3330(1)A0(2)	
160	90	0.068	4.0	9.0	10.0	7.5	310	99,200	21	8	16.4	3.73	88	75GD2680(1)40(2)	R75GD2680(1)40(2)	
160	90	0.082	4.0	9.0	10.0	7.5	310	99,200	25	8	13.6	4.10	88	75GD2820(1)40(2)	R75GD2820(1)40(2)	
160	90	0.1	5.0	10.5	10.0	7.5	310	99,200	31	8	11.1	4.80	78	75GD3100(1)40(2)	R75GD3100(1)40(2)	
160	90	0.12	5.0	10.5	10.0	7.5	310	99,200	37	8	9.3	5.25	78	75GD3120(1)40(2)	R75GD3120(1)40(2)	
160	90	0.15	6.0	12.0	10.5	7.5	310	99,200	47	8	7.4	6.23	69	75GD3150(1)00(2)	R75GD3150(1)00(2)	
160	90	0.18	6.0	12.0	10.5	7.5	310	99,200	56	8	10.6	5.21	69	75GD3180(1)30(2)	R75GD3180(1)30(2)	
160	90	0.082	4.0	9.0	13.0	10.0	200	64,000	16	9	19.4	3.62	79	75GF2820(1)00(2)	R75GF2820(1)00(2)	
160	90	0.1	4.0	9.0	13.0	10.0	200	64,000	20	9	15.9	4.00	79	75GF3100(1)30(2)	R75GF3100(1)30(2)	
160	90	0.12	5.0	11.0	13.0	10.0	200	64,000	24	9	13.3	4.67	69	75GF3120(1)00(2)	R75GF3120(1)00(2)	
160	90	0.15	5.0	11.0	13.0	10.0	200	64,000	30	9	10.6	5.22	69	75GF3150(1)00(2)	R75GF3150(1)00(2)	
160	90	0.18	6.0	12.0	13.0	10.0	200	64,000	36	9	13.3	4.86	64	75GF3180(1)00(2)	R75GF3180(1)00(2)	
160	90	0.22	6.0	12.0	13.0	10.0	200	64,000	44	9	10.9	5.37	64	75GF3220(1)30(2)	R75GF3220(1)30(2)	
160	90	0.15	5.0	11.0	18.0	15.0	120	38,400	18	10	10.6	5.59	60	75GI3150(1)00(2)	R75GI3150(1)00(2)	
160	90	0.18	5.0	11.0	18.0	15.0	120	38,400	22	10	13.3	5.00	60	75GI3180(1)00(2)	R75GI3180(1)00(2)	
160	90	0.22	5.0	11.0	18.0	15.0	120	38,400	26	10	10.9	5.53	60	75GI3220(1)00(2)	R75GI3220(1)00(2)	
160	90	0.27	6.0	12.0	18.0	15.0	120	38,400	32	10	17.7	4.50	56	75GI3270(1)00(2)	R75GI3270(1)00(2)	
160	90	0.33	6.0	12.0	18.0	15.0	120	38,400	40	10	14.5	4.97	56	75GI3330(1)00(2)	R75GI3330(1)00(2)	
160	90	0.39	7.5	13.5	18.0	15.0	120	38,400	47	10	12.2	5.68	51	75GI3390(1)00(2)	R75GI3390(1)00(2)	
160	90	0.47	7.5	13.5	18.0	15.0	120	38,400	56	10	10.2	6.23	51	75GI3470(1)00(2)	R75GI3470(1)00(2)	
160	90	0.47	9.0	12.5	18.0	15.0	120	38,400	56	10	10.2	6.30	50	75GI3470(1)60(2)	R75GI3470(1)60(2)	
160	90	0.56	8.5	14.5	18.0	15.0	120	38,400	67	10	8.5	7.01	48	75GI3560(1)00(2)	R75GI3560(1)00(2)	
160	90	0.56	9.0	12.5	18.0	15.0	120	38,400	67	10	8.5	6.88	50	75GI3560(1)60(2)	R75GI3560(1)60(2)	
160	90	0.68	8.5	14.5	18.0	15.0	120	38,400	82	10	7.0	7.72	48	75GI3680(1)00(2)	R75GI3680(1)00(2)	
160	90	0.68	13.0	12.0	18.0	15.0	120	38,400	82	10	7.0	7.96	45	75GI3680(1)60(2)	R75GI3680(1)60(2)	
160	90	0.82	10.0	16.0	18.0	15.0	120	38,400	98	10	5.8	8.83	44	75GI3820(1)00(2)	R75GI3820(1)00(2)	
160	90	1	10.0	16.0	18.0	15.0	120	38,400	120	10	4.8	9.75	44	75GI4100(1)00(2)	R75GI4100(1)00(2)	
160	90	0.82	7.0	16.0	26.5	22.5	70	22,400	57	16	9.7	7.09	41	75GN3820(1)00(2)	R75GN3820(1)00(2)	
160	90	1	7.0	16.0	26.5	22.5	70	22,400	70	16	8.0	7.83	41	75GN4100(1)00(2)	R75GN4100(1)00(2)	
160	90	1.2	8.5	17.0	26.5	22.5	70	22,400	84	16	13.3	6.27	38	75GN4120(1)00(2)	R75GN4120(1)00(2)	
VDC	VAC	Cap Value	T	H	L	Lead Spacing (S)	dV/dt (V/µs)	Max K <sub>0</sub> (V <sup>2</sup> /µs)	A <sub>pk</sub>	nH	mΩ	A <sub>rms</sub>	R <sub>th</sub>	KEMET Internal Part Number	Customer Part Number	
									I <sub>pk</sub>	ESL	ESR max	I <sub>rms</sub> max (*)				
			Dimensions							Lead Length 2x 4 mm	at 100 kHz	at 100 kHz, 85°C	(°C/W)			

(1) Insert lead and packaging code. See Ordering Options Table for available options.  
(2) J = 5%, K = 10%, M = 20%  
(3) K = 10%, M = 20%  
(4) H = 2.5%, J = 5%, K = 10%  
(\*) I<sub>rms</sub> value that leads to a ΔT of ≈ 20°C on the box surface > T<sub>BOX</sub> = T<sub>AMB</sub> + ΔT = 85°C + 20°C = 105°C

**Table 1 – Ratings & Part Number Reference cont.**

VDC	VAC	Cap Value (µF)	Dimensions in mm			Lead Spacing (S)	dV/dt (V/µs)	Max K <sub>0</sub> (V <sup>2</sup> /µs)	I <sub>pk</sub>	ESL	ESR max	I <sub>rms</sub> max (*)	R <sub>th</sub>	KEMET Internal Part Number	Customer Part Number
										Lead Length 2x 4 mm	at 100 kHz	at 100 kHz, 85°C			
			T	H	L				A <sub>pk</sub>	nH	mΩ	A <sub>rms</sub>	(°C/W)		
160	90	1.5	10.0	18.5	26.5	22.5	70	22,400	105	16	10.6	7.26	36	75GN4150(1)00(2)	R75GN4150(1)00(2)
160	90	1.8	10.0	18.5	26.5	22.5	70	22,400	126	16	8.8	7.95	36	75GN4180(1)00(2)	R75GN4180(1)00(2)
160	90	1.5	9.0	17.0	32.0	27.5	60	19,200	90	18	10.6	7.34	35	75GR4150(1)00(2)	R75GR4150(1)00(2)
160	90	1.8	9.0	17.0	32.0	27.5	60	19,200	108	18	8.8	8.05	35	75GR4180(1)00(2)	R75GR4180(1)00(2)
160	90	2.2	11.0	20.0	32.0	27.5	60	19,200	132	18	7.2	9.38	31	75GR4220(1)30(2)	R75GR4220(1)30(2)
160	90	2.7	11.0	20.0	32.0	27.5	60	19,200	162	18	8.8	8.49	31	75GR4270(1)00(2)	R75GR4270(1)00(2)
160	90	3.3	13.0	22.0	32.0	27.5	60	19,200	198	18	7.2	9.75	29	75GR4330(1)00(2)	R75GR4330(1)00(2)
160	90	3.3	24.0	15.0	32.0	27.5	60	19,200	198	18	7.2	10.09	27	75GR4330(1)L0(2)	R75GR4330(1)L0(2)
160	90	3.9	13.0	22.0	32.0	27.5	60	19,200	234	18	6.1	10.60	29	75GR4390(1)00(2)	R75GR4390(1)00(2)
160	90	3.9	24.0	15.0	32.0	27.5	60	19,200	234	18	6.1	10.97	27	75GR4390(1)L0(2)	R75GR4390(1)L0(2)
160	90	4.7	13.0	25.0	32.0	27.5	60	19,200	282	18	5.1	11.91	28	75GR4470(1)30(2)	R75GR4470(1)30(2)
160	90	5.6	14.0	28.0	32.0	27.5	60	19,200	336	18	4.3	13.41	26	75GR4560(1)00(2)	R75GR4560(1)00(2)
160	90	6.8	18.0	33.0	32.0	27.5	60	19,200	408	18	7.0	11.14	23	75GR4680(1)00(2)	R75GR4680(1)00(2)
160	90	8.2	18.0	33.0	32.0	27.5	60	19,200	492	18	5.8	12.24	23	75GR4820(1)00(2)	R75GR4820(1)00(2)
160	90	10	22.0	37.0	32.0	27.5	60	19,200	600	18	4.8	14.20	21	75GR5100(1)00(2)	R75GR5100(1)00(2)
160	90	12	22.0	37.0	32.0	27.5	60	19,200	720	18	4.0	15.56	21	75GR5120(1)00(2)	R75GR5120(1)00(2)
160	90	3.3	11.0	22.0	41.5	37.5	35	11,200	116	20	7.2	10.10	27	75GW4330(1)00(2)	R75GW4330(1)00(2)
160	90	3.9	11.0	22.0	41.5	37.5	35	11,200	137	20	6.1	10.98	27	75GW4390(1)00(2)	R75GW4390(1)00(2)
160	90	4.7	11.0	22.0	41.5	37.5	35	11,200	165	20	5.1	12.05	27	75GW4470(1)00(2)	R75GW4470(1)00(2)
160	90	5.6	13.0	24.0	41.5	37.5	35	11,200	196	20	4.3	13.63	25	75GW4560(1)00(2)	R75GW4560(1)00(2)
160	90	6.8	16.0	28.5	41.5	37.5	35	11,200	238	20	7.0	11.24	23	75GW4680(1)00(2)	R75GW4680(1)00(2)
160	90	8.2	16.0	28.5	41.5	37.5	35	11,200	287	20	5.8	12.34	23	75GW4820(1)00(2)	R75GW4820(1)00(2)
160	90	8.2	24.0	19.0	41.5	37.5	35	11,200	287	20	5.8	12.26	23	75GW4820(1)L0(2)	R75GW4820(1)L0(2)
160	90	10	19.0	32.0	41.5	37.5	35	11,200	350	20	4.8	14.23	21	75GW5100(1)00(2)	R75GW5100(1)00(2)
160	90	12	19.0	32.0	41.5	37.5	35	11,200	420	20	4.0	15.59	21	75GW5120(1)00(2)	R75GW5120(1)00(2)
160	90	15	20.0	40.0	41.5	37.5	35	11,200	525	20	3.2	18.30	19	75GW5150(1)00(2)	R75GW5150(1)00(2)
160	90	18	20.0	40.0	41.5	37.5	35	11,200	630	20	2.7	20.05	19	75GW5180(1)00(2)	R75GW5180(1)00(2)
160	90	22	24.0	44.0	41.5	37.5	35	11,200	770	20	2.2	23.13	17	75GW5220(1)00(2)	R75GW5220(1)00(2)
160	90	27	30.0	45.0	41.5	37.5	35	11,200	945	20	1.8	26.57	16	75GW5270(1)00(2)	R75GW5270(1)00(2)
160	90	33	30.0	45.0	41.5	37.5	35	11,200	1,155	20	1.4	29.37	16	75GW5330(1)00(2)	R75GW5330(1)00(2)
250	140	0.068	4.0	9.0	10.0	7.5	180	90,000	12	8	16.4	3.73	88	75ID2680(1)B0(2)	R75ID2680(1)B0(2)
250	140	0.082	4.0	9.0	10.0	7.5	180	90,000	15	8	13.6	4.10	88	75ID2820(1)B0(2)	R75ID2820(1)B0(2)
250	140	0.1	5.0	10.5	10.0	7.5	180	90,000	18	8	11.1	4.80	78	75ID3100(1)B0(2)	R75ID3100(1)B0(2)
250	140	0.12	5.0	10.5	10.0	7.5	180	90,000	22	8	9.3	5.25	78	75ID3120(1)B0(2)	R75ID3120(1)B0(2)
250	140	0.15	6.0	12.0	10.5	7.5	180	90,000	27	8	7.4	6.23	69	75ID3150(1)A0(2)	R75ID3150(1)A0(2)
250	140	0.18	6.0	12.0	10.5	7.5	180	90,000	32	8	10.6	5.21	69	75ID3180(1)A0(2)	R75ID3180(1)A0(2)
250	140	0.082	4.0	9.0	13.0	10.0	150	75,000	12	9	19.4	3.62	79	75IF2820(1)A0(2)	R75IF2820(1)A0(2)
250	140	0.1	4.0	9.0	13.0	10.0	150	75,000	15	9	15.9	4.00	79	75IF3100(1)A0(2)	R75IF3100(1)A0(2)
250	140	0.12	5.0	11.0	13.0	10.0	150	75,000	18	9	13.3	4.67	69	75IF3120(1)A0(2)	R75IF3120(1)A0(2)
250	140	0.15	5.0	11.0	13.0	10.0	150	75,000	23	9	10.6	5.22	69	75IF3150(1)A0(2)	R75IF3150(1)A0(2)
250	140	0.18	6.0	12.0	13.0	10.0	150	75,000	27	9	13.3	4.86	64	75IF3180(1)A0(2)	R75IF3180(1)A0(2)
250	140	0.22	6.0	12.0	13.0	10.0	150	75,000	33	9	10.9	5.37	64	75IF3220(1)A0(2)	R75IF3220(1)A0(2)
250	160	0.012	3.5	7.5	7.2	5.0	250	125,000	3	7	397.9	0.67	111	75IC2120(1)45(4)	R75IC2120(1)45(4)
250	160	0.015	3.5	7.5	7.2	5.0	250	125,000	4	7	318.3	0.75	111	75IC2150(1)45(4)	R75IC2150(1)45(4)
250	160	0.018	3.5	7.5	7.2	5.0	250	125,000	5	7	265.3	0.83	111	75IC2180(1)45(4)	R75IC2180(1)45(4)
250	160	0.022	3.5	7.5	7.2	5.0	250	125,000	6	7	217.0	0.91	111	75IC2220(1)45(4)	R75IC2220(1)45(4)
250	160	0.027	3.5	7.5	7.2	5.0	250	125,000	7	7	176.8	1.01	111	75IC2270(1)45(4)	R75IC2270(1)45(4)
250	160	0.033	3.5	7.5	7.2	5.0	250	125,000	8	7	144.7	1.12	111	75IC2330(1)45(4)	R75IC2330(1)45(4)
250	160	0.039	4.5	9.5	7.2	5.0	250	125,000	10	7	122.4	1.32	94	75IC2390(1)40(4)	R75IC2390(1)40(4)
VDC	VAC	Cap Value	T	H	L	Lead Spacing (S)	dV/dt (V/µs)	Max K <sub>0</sub> (V <sup>2</sup> /µs)	A <sub>pk</sub>	ESL	ESR max	A <sub>rms</sub>	R <sub>th</sub>	KEMET Internal Part Number	Customer Part Number
									I <sub>pk</sub>	Lead Length 2x 4 mm	at 100 kHz	at 100 kHz, 85°C			
			Dimensions						I <sub>pk</sub>	ESL	ESR max	I <sub>rms</sub> max (*)	R <sub>th</sub>		

(1) Insert lead and packaging code. See Ordering Options Table for available options.  
(2) J = 5%, K = 10%, M = 20%  
(3) K = 10%, M = 20%  
(4) H = 2.5%, J = 5%, K = 10%  
(\*) I<sub>rms</sub> value that leads to a ΔT of ≈ 20°C on the box surface > T<sub>BOX</sub> = T<sub>AMB</sub> + ΔT = 85°C + 20°C = 105°C

**Table 1 – Ratings & Part Number Reference cont.**

VDC	VAC	Cap Value (µF)	Dimensions in mm			Lead Spacing (S)	dV/dt (V/µs)	Max $K_0$ (V <sup>2</sup> /µs)	$I_{pk}$	ESL	ESR max	$I_{rms}$ max (*)		$R_{th}$	KEMET Internal Part Number	Customer Part Number
										Lead Length 2x 4 mm	at 100 kHz	at 100 kHz, 85°C	(°C/W)			
			T	H	L				$A_{pk}$	nH	mΩ	$A_{rms}$	(°C/W)			
250	160	0.047	4.5	9.5	7.2	5.0	250	125,000	12	7	101.6	1.44	94	751C2470(1)40(4)	R751C2470(1)40(4)	
250	160	0.056	4.5	9.5	7.2	5.0	250	125,000	14	7	85.3	1.58	94	751C2560(1)40(4)	R751C2560(1)40(4)	
250	160	0.068	5.0	10.0	7.2	5.0	250	125,000	17	7	70.2	1.78	90	751C2680(1)40(4)	R751C2680(1)40(4)	
250	160	0.082	6.0	11.0	7.2	5.0	250	125,000	21	7	58.2	2.05	82	751C2820(1)40(4)	R751C2820(1)40(4)	
250	160	0.1	6.0	11.0	7.2	5.0	250	125,000	25	7	47.7	2.26	82	751C3100(1)40(4)	R751C3100(1)40(4)	
250	160	0.12	7.2	13.0	7.2	5.0	250	125,000	30	7	39.8	2.63	73	751C3120(1)40(4)	R751C3120(1)40(4)	
250	160	0.15	7.2	13.0	7.2	5.0	250	125,000	38	7	31.8	2.94	73	751C3150(1)40(4)	R751C3150(1)40(4)	
250	160	0.027	4.0	9.0	10.0	7.5	650	325,000	18	8	41.3	2.35	88	751D2270(1)40(2)	R751D2270(1)40(2)	
250	160	0.033	4.0	9.0	10.0	7.5	650	325,000	21	8	33.8	2.60	88	751D2330(1)40(2)	R751D2330(1)40(2)	
250	160	0.039	4.0	9.0	10.0	7.5	650	325,000	25	8	28.6	2.83	88	751D2390(1)40(2)	R751D2390(1)40(2)	
250	160	0.047	4.0	9.0	10.0	7.5	650	325,000	31	8	23.7	3.10	88	751D2470(1)40(2)	R751D2470(1)40(2)	
250	160	0.056	4.0	9.0	10.0	7.5	650	325,000	36	8	19.9	3.39	88	751D2560(1)40(2)	R751D2560(1)40(2)	
250	160	0.068	5.0	10.5	10.0	7.5	650	325,000	44	8	16.4	3.95	78	751D2680(1)40(2)	R751D2680(1)40(2)	
250	160	0.082	5.0	10.5	10.0	7.5	650	325,000	53	8	13.6	4.34	78	751D2820(1)40(2)	R751D2820(1)40(2)	
250	160	0.1	6.0	12.0	10.5	7.5	650	325,000	65	8	11.1	5.09	69	751D3100(1)30(2)	R751D3100(1)30(2)	
250	160	0.12	6.0	12.0	10.5	7.5	650	325,000	78	8	9.3	5.57	69	751D3120(1)30(2)	R751D3120(1)30(2)	
250	160	0.033	4.0	9.0	13.0	10.0	570	285,000	19	9	33.8	2.75	79	751F2330(1)00(2)	R751F2330(1)00(2)	
250	160	0.039	4.0	9.0	13.0	10.0	570	285,000	22	9	28.6	2.99	79	751F2390(1)00(2)	R751F2390(1)00(2)	
250	160	0.047	4.0	9.0	13.0	10.0	570	285,000	27	9	23.7	3.28	79	751F2470(1)30(2)	R751F2470(1)30(2)	
250	160	0.056	4.0	9.0	13.0	10.0	570	285,000	32	9	28.4	2.99	79	751F2560(1)30(2)	R751F2560(1)30(2)	
250	160	0.068	4.0	9.0	13.0	10.0	570	285,000	39	9	23.4	3.30	79	751F2680(1)30(2)	R751F2680(1)30(2)	
250	160	0.082	4.0	9.0	13.0	10.0	570	285,000	47	9	19.4	3.62	79	751F2820(1)40(2)	R751F2820(1)40(2)	
250	160	0.082	5.0	11.0	13.0	10.0	570	285,000	47	9	19.4	3.86	69	751F2820(1)30(2)	R751F2820(1)30(2)	
250	160	0.1	4.0	9.0	13.0	10.0	570	285,000	57	9	15.9	4.00	79	751F3100(1)40(2)	R751F3100(1)40(2)	
250	160	0.1	5.0	11.0	13.0	10.0	570	285,000	57	9	15.9	4.27	69	751F3100(1)30(2)	R751F3100(1)30(2)	
250	160	0.12	5.0	11.0	13.0	10.0	570	285,000	68	9	13.3	4.67	69	751F3120(1)40(2)	R751F3120(1)40(2)	
250	160	0.12	6.0	12.0	13.0	10.0	570	285,000	68	9	13.3	4.86	64	751F3120(1)30(2)	R751F3120(1)30(2)	
250	160	0.15	5.0	11.0	13.0	10.0	570	285,000	86	9	10.6	5.22	69	751F3150(1)40(2)	R751F3150(1)40(2)	
250	160	0.15	6.0	12.0	13.0	10.0	570	285,000	86	9	10.6	5.43	64	751F3150(1)30(2)	R751F3150(1)30(2)	
250	160	0.18	6.0	12.0	13.0	10.0	570	285,000	103	9	13.3	4.86	64	751F3180(1)40(2)	R751F3180(1)40(2)	
250	160	0.22	6.0	12.0	13.0	10.0	570	285,000	125	9	10.9	5.37	64	751F3220(1)40(2)	R751F3220(1)40(2)	
250	160	0.27	6.0	12.0	13.0	10.0	570	285,000	154	9	17.7	4.21	64	751F3270(1)40(2)	R751F3270(1)40(2)	
250	160	0.1	5.0	11.0	18.0	15.0	310	155,000	31	10	15.9	4.57	60	751I3100(1)00(2)	R751I3100(1)00(2)	
250	160	0.12	5.0	11.0	18.0	15.0	310	155,000	37	10	13.3	5.00	60	751I3120(1)30(2)	R751I3120(1)30(2)	
250	160	0.15	5.0	11.0	18.0	15.0	310	155,000	47	10	10.6	5.59	60	751I3150(1)30(2)	R751I3150(1)30(2)	
250	160	0.18	5.0	11.0	18.0	15.0	310	155,000	56	10	13.3	5.00	60	751I3180(1)40(2)	R751I3180(1)40(2)	
250	160	0.22	5.0	11.0	18.0	15.0	310	155,000	68	10	10.9	5.53	60	751I3220(1)40(2)	R751I3220(1)40(2)	
250	160	0.27	6.0	12.0	18.0	15.0	310	155,000	84	10	17.7	4.50	56	751I3270(1)40(2)	R751I3270(1)40(2)	
250	160	0.33	6.0	12.0	18.0	15.0	310	155,000	102	10	14.5	4.97	56	751I3330(1)40(2)	R751I3330(1)40(2)	
250	160	0.39	7.5	13.5	18.0	15.0	310	155,000	121	10	12.2	5.68	51	751I3390(1)40(2)	R751I3390(1)40(2)	
250	160	0.39	9.0	12.5	18.0	15.0	310	155,000	121	10	12.2	5.74	50	751I3390(1)70(2)	R751I3390(1)70(2)	
250	160	0.47	7.5	13.5	18.0	15.0	310	155,000	146	10	10.2	6.23	51	751I3470(1)40(2)	R751I3470(1)40(2)	
250	160	0.47	9.0	12.5	18.0	15.0	310	155,000	146	10	10.2	6.30	50	751I3470(1)80(2)	R751I3470(1)80(2)	
250	160	0.56	7.5	13.5	18.0	15.0	310	155,000	174	10	8.5	6.80	51	751I3560(1)40(2)	R751I3560(1)40(2)	
250	160	0.56	9.0	12.5	18.0	15.0	310	155,000	174	10	8.5	6.88	50	751I3560(1)80(2)	R751I3560(1)80(2)	
250	160	0.68	8.5	14.5	18.0	15.0	310	155,000	211	10	7.0	7.72	48	751I3680(1)40(2)	R751I3680(1)40(2)	
250	160	0.68	13.0	12.0	18.0	15.0	310	155,000	211	10	7.0	7.96	45	751I3680(1)80(2)	R751I3680(1)80(2)	
250	160	0.82	10.0	16.0	18.0	15.0	310	155,000	254	10	5.8	8.83	44	751I3820(1)40(2)	R751I3820(1)40(2)	
250	160	0.82	13.0	12.0	18.0	15.0	310	155,000	254	10	5.8	8.75	45	751I3820(1)80(2)	R751I3820(1)80(2)	
250	160	1	10.0	16.0	18.0	15.0	310	155,000	310	10	4.8	9.75	44	751I4100(1)40(2)	R751I4100(1)40(2)	
VDC	VAC	Cap Value	T	H	L	Lead Spacing (S)	dV/dt (V/µs)	Max $K_0$ (V <sup>2</sup> /µs)	$A_{pk}$	nH	mΩ	$A_{rms}$	(°C/W)	KEMET Internal Part Number	Customer Part Number	
										Lead Length 2x 4 mm	at 100 kHz	at 100 kHz, 85°C				
			Dimensions						$I_{pk}$	ESL	ESR max	$I_{rms}$ max (*)	$R_{th}$			

(1) Insert lead and packaging code. See Ordering Options Table for available options.  
(2) J = 5%, K = 10%, M = 20%  
(3) K = 10%, M = 20%  
(4) H = 2.5%, J = 5%, K = 10%  
(\*)  $I_{rms}$  value that leads to a  $\Delta T$  of  $\approx 20^\circ\text{C}$  on the box surface  $> T_{BOX} = T_{AMB} + \Delta T = 85^\circ\text{C} + 20^\circ\text{C} = 105^\circ\text{C}$

**Table 1 – Ratings & Part Number Reference cont.**

VDC	VAC	Cap Value (µF)	Dimensions in mm			Lead Spacing (S)	dV/dt (V/µs)	Max K <sub>0</sub> (V <sup>2</sup> /µs)	I <sub>pk</sub>	ESL	ESR max	I <sub>rms</sub> max (*)	R <sub>th</sub>	KEMET Internal Part Number	Customer Part Number
										Lead Length 2x 4 mm	at 100 kHz	at 100 kHz, 85°C			
			T	H	L				A <sub>pk</sub>	nH	mΩ	A <sub>rms</sub>	(°C/W)		
250	160	1.2	11.0	19.0	18.0	15.0	310	155,000	372	10	6.6	8.66	40	75I4120(1)40(2)	R75I4120(1)40(2)
250	160	0.22	6.0	15.0	26.5	22.5	130	65,000	29	16	12.3	6.12	43	75IN3220(1)30(2)	R75IN3220(1)30(2)
250	160	0.33	6.0	15.0	26.5	22.5	130	65,000	43	16	9.6	6.91	43	75IN3330(1)30(2)	R75IN3330(1)30(2)
250	160	0.39	6.0	15.0	26.5	22.5	130	65,000	51	16	10.2	6.72	43	75IN3390(1)30(2)	R75IN3390(1)30(2)
250	160	0.47	6.0	15.0	26.5	22.5	130	65,000	61	16	8.5	7.38	43	75IN3470(1)30(2)	R75IN3470(1)30(2)
250	160	0.56	6.0	15.0	26.5	22.5	130	65,000	73	16	11.4	6.37	43	75IN3560(1)40(2)	R75IN3560(1)40(2)
250	160	0.68	6.0	15.0	26.5	22.5	130	65,000	88	16	9.4	7.01	43	75IN3680(1)40(2)	R75IN3680(1)40(2)
250	160	0.82	7.0	16.0	26.5	22.5	130	65,000	107	16	9.7	7.09	41	75IN3820(1)40(2)	R75IN3820(1)40(2)
250	160	1	7.0	16.0	26.5	22.5	130	65,000	130	16	8.0	7.83	41	75IN4100(1)40(2)	R75IN4100(1)40(2)
250	160	1.2	8.5	17.0	26.5	22.5	130	65,000	156	16	13.3	6.27	38	75IN4120(1)40(2)	R75IN4120(1)40(2)
250	160	1.5	10.0	18.5	26.5	22.5	130	65,000	195	16	10.6	7.26	36	75IN4150(1)40(2)	R75IN4150(1)40(2)
250	160	1.8	10.0	18.5	26.5	22.5	130	65,000	234	16	8.8	7.95	36	75IN4180(1)40(2)	R75IN4180(1)40(2)
250	160	2.2	11.0	20.0	26.5	22.5	130	65,000	286	16	7.2	9.02	34	75IN4220(1)40(2)	R75IN4220(1)40(2)
250	160	2.7	13.0	22.0	26.5	22.5	130	65,000	351	16	8.8	8.49	31	75IN4270(1)40(2)	R75IN4270(1)40(2)
250	160	3.3	13.0	22.0	26.5	22.5	130	65,000	429	16	7.2	9.39	31	75IN4330(1)40(2)	R75IN4330(1)40(2)
250	160	1	9.0	17.0	32.0	27.5	100	50,000	100	18	8.0	8.48	35	75IR4100(1)30(2)	R75IR4100(1)30(2)
250	160	1.2	9.0	17.0	32.0	27.5	100	50,000	120	18	13.3	6.57	35	75IR4120(1)30(2)	R75IR4120(1)30(2)
250	160	1.5	9.0	17.0	32.0	27.5	100	50,000	150	18	10.6	7.34	35	75IR4150(1)40(2)	R75IR4150(1)40(2)
250	160	1.8	9.0	17.0	32.0	27.5	100	50,000	180	18	8.8	8.05	35	75IR4180(1)40(2)	R75IR4180(1)40(2)
250	160	2.2	11.0	20.0	32.0	27.5	100	50,000	220	18	7.2	9.38	31	75IR4220(1)50(2)	R75IR4220(1)50(2)
250	160	2.7	11.0	20.0	32.0	27.5	100	50,000	270	18	8.8	8.49	31	75IR4270(1)40(2)	R75IR4270(1)40(2)
250	160	3.3	11.0	20.0	32.0	27.5	100	50,000	330	18	7.2	9.38	31	75IR4330(1)50(2)	R75IR4330(1)50(2)
250	160	3.3	13.0	22.0	32.0	27.5	100	50,000	330	18	7.2	9.75	29	75IR4330(1)40(2)	R75IR4330(1)40(2)
250	160	3.3	24.0	15.0	32.0	27.5	100	50,000	330	18	7.2	10.09	27	75IR4330(1)L4(2)	R75IR4330(1)L4(2)
250	160	3.9	13.0	22.0	32.0	27.5	100	50,000	390	18	6.1	10.60	29	75IR4390(1)40(2)	R75IR4390(1)40(2)
250	160	3.9	24.0	15.0	32.0	27.5	100	50,000	390	18	6.1	10.97	27	75IR4390(1)L4(2)	R75IR4390(1)L4(2)
250	160	4.7	13.0	25.0	32.0	27.5	100	50,000	470	18	5.1	11.91	28	75IR4470(1)50(2)	R75IR4470(1)50(2)
250	160	5.6	14.0	28.0	32.0	27.5	100	50,000	560	18	4.3	13.41	26	75IR4560(1)40(2)	R75IR4560(1)40(2)
250	160	6.8	18.0	33.0	32.0	27.5	100	50,000	680	18	7.0	11.14	23	75IR4680(1)40(2)	R75IR4680(1)40(2)
250	160	8.2	18.0	33.0	32.0	27.5	100	50,000	820	18	5.8	12.24	23	75IR4820(1)40(2)	R75IR4820(1)40(2)
250	160	10	22.0	37.0	32.0	27.5	100	50,000	1,000	18	4.8	14.20	21	75IR5100(1)40(2)	R75IR5100(1)40(2)
250	160	12	22.0	37.0	32.0	27.5	100	50,000	1,200	18	4.0	15.56	21	75IR5120(1)40(2)	R75IR5120(1)40(2)
250	160	2.7	11.0	22.0	41.5	37.5	40	20,000	108	20	8.8	9.14	27	75IW4270(1)40(2)	R75IW4270(1)40(2)
250	160	3	11.0	22.0	41.5	37.5	40	20,000	120	20	8.0	9.63	27	75IW4300(1)40(2)	R75IW4300(1)40(2)
250	160	3.3	11.0	22.0	41.5	37.5	40	20,000	132	20	7.2	10.10	27	75IW4330(1)40(2)	R75IW4330(1)40(2)
250	160	3.9	11.0	22.0	41.5	37.5	40	20,000	156	20	6.1	10.98	27	75IW4390(1)40(2)	R75IW4390(1)40(2)
250	160	3.9	24.0	15.0	41.5	37.5	40	20,000	156	20	6.1	11.58	24	75IW4390(1)L4(2)	R75IW4390(1)L4(2)
250	160	4.7	11.0	22.0	41.5	37.5	40	20,000	188	20	5.1	12.05	27	75IW4470(1)40(2)	R75IW4470(1)40(2)
250	160	4.7	24.0	15.0	41.5	37.5	40	20,000	188	20	5.1	12.71	24	75IW4470(1)L4(2)	R75IW4470(1)L4(2)
250	160	5.6	13.0	24.0	41.5	37.5	40	20,000	224	20	4.3	13.63	25	75IW4560(1)40(2)	R75IW4560(1)40(2)
250	160	5.6	24.0	15.0	41.5	37.5	40	20,000	224	20	4.3	13.87	24	75IW4560(1)L4(2)	R75IW4560(1)L4(2)
250	160	6.8	16.0	28.5	41.5	37.5	40	20,000	272	20	7.0	11.24	23	75IW4680(1)40(2)	R75IW4680(1)40(2)
250	160	6.8	24.0	19.0	41.5	37.5	40	20,000	272	20	7.0	11.16	23	75IW4680(1)L4(2)	R75IW4680(1)L4(2)
250	160	8.2	16.0	28.5	41.5	37.5	40	20,000	328	20	5.8	12.34	23	75IW4820(1)40(2)	R75IW4820(1)40(2)
250	160	8.2	24.0	19.0	41.5	37.5	40	20,000	328	20	5.8	12.26	23	75IW4820(1)L4(2)	R75IW4820(1)L4(2)
250	160	10	19.0	32.0	41.5	37.5	40	20,000	400	20	4.8	14.23	21	75IW5100(1)40(2)	R75IW5100(1)40(2)
250	160	12	19.0	32.0	41.5	37.5	40	20,000	480	20	4.0	15.59	21	75IW5120(1)40(2)	R75IW5120(1)40(2)
250	160	15	20.0	40.0	41.5	37.5	40	20,000	600	20	3.2	18.30	19	75IW5150(1)40(2)	R75IW5150(1)40(2)
250	160	18	20.0	40.0	41.5	37.5	40	20,000	720	20	2.7	20.05	19	75IW5180(1)40(2)	R75IW5180(1)40(2)
250	160	22	24.0	44.0	41.5	37.5	40	20,000	880	20	2.2	23.13	17	75IW5220(1)40(2)	R75IW5220(1)40(2)
VDC	VAC	Cap Value	T	H	L	Lead Spacing (S)	dV/dt (V/µs)	Max K <sub>0</sub> (V <sup>2</sup> /µs)	A <sub>pk</sub>	Lead Length 2x 4 mm	at 100 kHz	A <sub>rms</sub>	(°C/W)	KEMET Internal Part Number	Customer Part Number
									I <sub>pk</sub>	ESL	ESR max	I <sub>rms</sub> max (*)	R <sub>th</sub>		
			Dimensions						I <sub>pk</sub>	ESL	ESR max	I <sub>rms</sub> max (*)	R <sub>th</sub>		

(1) Insert lead and packaging code. See Ordering Options Table for available options.  
(2) J = 5%, K = 10%, M = 20%  
(3) K = 10%, M = 20%  
(4) H = 2.5%, J = 5%, K = 10%  
(\*) I<sub>rms</sub> value that leads to a ΔT of ≈ 20°C on the box surface > T<sub>BOX</sub> = T<sub>AMB</sub> + ΔT = 85°C + 20°C = 105°C

**Table 1 – Ratings & Part Number Reference cont.**

VDC	VAC	Cap Value (µF)	Dimensions in mm			Lead Spacing (S)	dV/dt (V/µs)	Max K <sub>v</sub> (V <sup>2</sup> /µs)	I <sub>pk</sub>	ESL	ESR max	I <sub>rms</sub> max (*)		R <sub>th</sub>	KEMET Internal Part Number	Customer Part Number
										Lead Length 2x 4 mm	at 100 kHz	at 100 kHz, 85°C	A <sub>rms</sub>			
			T	H	L					A <sub>pk</sub>	nH	mΩ	(°C/W)			
250	160	27	24.0	44.0	41.5	37.5	40	20,000	1,080	20	1.8	25.62	17	75IW5270(1)40(2)	R75IW5270(1)40(2)	
250	160	33	30.0	45.0	41.5	37.5	40	20,000	1,320	20	1.4	29.37	16	75IW5330(1)40(2)	R75IW5330(1)40(2)	
400	200	0.0039	3.5	7.5	7.2	5.0	400	320,000	2	7	1224.3	0.38	111	75MC1390(1)40(4)	R75MC1390(1)40(4)	
400	200	0.0047	3.5	7.5	7.2	5.0	400	320,000	2	7	1015.9	0.42	111	75MC1470(1)40(4)	R75MC1470(1)40(4)	
400	200	0.0056	3.5	7.5	7.2	5.0	400	320,000	2	7	852.6	0.46	111	75MC1560(1)40(4)	R75MC1560(1)40(4)	
400	200	0.0068	3.5	7.5	7.2	5.0	400	320,000	3	7	702.2	0.51	111	75MC1680(1)40(4)	R75MC1680(1)40(4)	
400	200	0.0082	3.5	7.5	7.2	5.0	400	320,000	3	7	582.3	0.56	111	75MC1820(1)40(4)	R75MC1820(1)40(4)	
400	200	0.01	3.5	7.5	7.2	5.0	400	320,000	4	7	477.5	0.62	111	75MC2100(1)40(4)	R75MC2100(1)40(4)	
400	200	0.012	4.5	9.5	7.2	5.0	400	320,000	5	7	397.9	0.73	94	75MC2120(1)40(4)	R75MC2120(1)40(4)	
400	200	0.015	4.5	9.5	7.2	5.0	400	320,000	6	7	318.3	0.82	94	75MC2150(1)40(4)	R75MC2150(1)40(4)	
400	200	0.018	5.0	10.0	7.2	5.0	400	320,000	7	7	265.3	0.92	90	75MC2180(1)40(4)	R75MC2180(1)40(4)	
400	200	0.022	5.0	10.0	7.2	5.0	400	320,000	9	7	217.0	1.01	90	75MC2220(1)40(4)	R75MC2220(1)40(4)	
400	200	0.027	6.0	11.0	7.2	5.0	400	320,000	11	7	176.8	1.17	82	75MC2270(1)40(4)	R75MC2270(1)40(4)	
400	200	0.033	6.0	11.0	7.2	5.0	400	320,000	13	7	144.7	1.30	82	75MC2330(1)40(4)	R75MC2330(1)40(4)	
400	200	0.039	7.2	13.0	7.2	5.0	400	320,000	16	7	122.4	1.50	73	75MC2390(1)40(4)	R75MC2390(1)40(4)	
400	200	0.047	7.2	13.0	7.2	5.0	400	320,000	19	7	101.6	1.65	73	75MC2470(1)40(4)	R75MC2470(1)40(4)	
400	200	0.027	4.0	9.0	10.0	7.5	390	312,000	11	8	41.3	2.35	88	75MD2270(1)B0(2)	R75MD2270(1)B0(2)	
400	200	0.033	5.0	10.5	10.0	7.5	390	312,000	13	8	33.8	2.75	78	75MD2330(1)B0(2)	R75MD2330(1)B0(2)	
400	200	0.039	5.0	10.5	10.0	7.5	390	312,000	15	8	28.6	2.99	78	75MD2390(1)B0(2)	R75MD2390(1)B0(2)	
400	200	0.047	5.0	10.5	10.0	7.5	390	312,000	18	8	23.7	3.29	78	75MD2470(1)B0(2)	R75MD2470(1)B0(2)	
400	200	0.056	6.0	12.0	10.5	7.5	390	312,000	22	8	19.9	3.81	69	75MD2560(1)A0(2)	R75MD2560(1)A0(2)	
400	200	0.068	6.0	12.0	10.5	7.5	390	312,000	27	8	16.4	4.20	69	75MD2680(1)A0(2)	R75MD2680(1)A0(2)	
400	220	0.01	4.0	9.0	10.0	7.5	1,500	1,200,000	15	8	79.6	1.38	88	75MD2100(1)40(2)	R75MD2100(1)40(2)	
400	220	0.012	4.0	9.0	10.0	7.5	1,500	1,200,000	18	8	92.8	1.57	88	75MD2120(1)40(2)	R75MD2120(1)40(2)	
400	220	0.015	4.0	9.0	10.0	7.5	1,500	1,200,000	23	8	74.3	1.75	88	75MD2150(1)40(2)	R75MD2150(1)40(2)	
400	220	0.018	4.0	9.0	10.0	7.5	1,500	1,200,000	27	8	61.9	1.92	88	75MD2180(1)40(2)	R75MD2180(1)40(2)	
400	220	0.022	4.0	9.0	10.0	7.5	1,500	1,200,000	33	8	50.6	2.12	88	75MD2220(1)40(2)	R75MD2220(1)40(2)	
400	220	0.027	5.0	10.5	10.0	7.5	1,500	1,200,000	41	8	41.3	2.49	78	75MD2270(1)40(2)	R75MD2270(1)40(2)	
400	220	0.033	5.0	10.5	10.0	7.5	1,500	1,200,000	50	8	33.8	2.75	78	75MD2330(1)40(2)	R75MD2330(1)40(2)	
400	220	0.039	6.0	12.0	10.5	7.5	1,500	1,200,000	59	8	28.6	3.18	69	75MD2390(1)30(2)	R75MD2390(1)30(2)	
400	220	0.047	6.0	12.0	10.5	7.5	1,500	1,200,000	71	8	23.7	3.49	69	75MD2470(1)30(2)	R75MD2470(1)30(2)	
400	220	0.015	4.0	9.0	13.0	10.0	1,300	1,040,000	20	9	74.3	1.85	79	75MF2150(1)00(2)	R75MF2150(1)00(2)	
400	220	0.018	4.0	9.0	13.0	10.0	1,300	1,040,000	23	9	61.9	2.03	79	75MF2180(1)00(2)	R75MF2180(1)00(2)	
400	220	0.022	4.0	9.0	13.0	10.0	1,300	1,040,000	29	9	50.6	2.24	79	75MF2220(1)30(2)	R75MF2220(1)30(2)	
400	220	0.027	4.0	9.0	13.0	10.0	1,300	1,040,000	35	9	41.3	2.48	79	75MF2270(1)30(2)	R75MF2270(1)30(2)	
400	220	0.033	5.0	11.0	13.0	10.0	1,300	1,040,000	43	9	33.8	2.93	69	75MF2330(1)30(2)	R75MF2330(1)30(2)	
400	220	0.039	5.0	11.0	13.0	10.0	1,300	1,040,000	51	9	28.6	3.18	69	75MF2390(1)30(2)	R75MF2390(1)30(2)	
400	220	0.047	5.0	11.0	13.0	10.0	1,300	1,040,000	61	9	23.7	3.50	69	75MF2470(1)30(2)	R75MF2470(1)30(2)	
400	220	0.056	6.0	12.0	13.0	10.0	1,300	1,040,000	73	9	28.4	3.32	64	75MF2560(1)30(2)	R75MF2560(1)30(2)	
400	220	0.068	6.0	12.0	13.0	10.0	1,300	1,040,000	88	9	23.4	3.66	64	75MF2680(1)30(2)	R75MF2680(1)30(2)	
400	220	0.068	5.0	11.0	18.0	15.0	900	720,000	61	10	23.4	3.77	60	75MI2680(1)30(2)	R75MI2680(1)30(2)	
400	220	0.082	5.0	11.0	18.0	15.0	900	720,000	74	10	19.4	4.14	60	75MI2820(1)30(2)	R75MI2820(1)30(2)	
400	220	0.1	5.0	11.0	18.0	15.0	900	720,000	90	10	15.9	4.57	60	75MI3100(1)30(2)	R75MI3100(1)30(2)	
400	220	0.12	6.0	12.0	18.0	15.0	900	720,000	108	10	13.3	5.19	56	75MI3120(1)30(2)	R75MI3120(1)30(2)	
400	220	0.15	6.0	12.0	18.0	15.0	900	720,000	135	10	10.6	5.81	56	75MI3150(1)30(2)	R75MI3150(1)30(2)	
400	220	0.18	7.5	13.5	18.0	15.0	900	720,000	162	10	13.3	5.45	51	75MI3180(1)30(2)	R75MI3180(1)30(2)	
400	220	0.22	7.5	13.5	18.0	15.0	900	720,000	198	10	10.9	6.03	51	75MI3220(1)30(2)	R75MI3220(1)30(2)	
400	220	0.22	9.0	12.5	18.0	15.0	900	720,000	198	10	10.9	6.10	50	75MI3220(1)70(2)	R75MI3220(1)70(2)	
400	220	0.27	8.5	14.5	18.0	15.0	900	720,000	243	10	17.7	4.87	48	75MI3270(1)30(2)	R75MI3270(1)30(2)	
400	220	0.27	9.0	12.5	18.0	15.0	900	720,000	243	10	17.7	4.77	50	75MI3270(1)70(2)	R75MI3270(1)70(2)	
VDC	VAC	Cap Value	T	H	L	Lead Spacing (S)	dV/dt (V/µs)	Max K <sub>v</sub> (V <sup>2</sup> /µs)	A <sub>pk</sub>	Lead Length 2x 4 mm	at 100 kHz	A <sub>rms</sub>	(°C/W)	KEMET Internal Part Number	Customer Part Number	
									I <sub>pk</sub>	ESL	ESR max	I <sub>rms</sub> max (*)				
			Dimensions						I <sub>pk</sub>	ESL	ESR max	I <sub>rms</sub> max (*)	R <sub>th</sub>			

(1) Insert lead and packaging code. See Ordering Options Table for available options.  
(2) J = 5%, K = 10%, M = 20%  
(3) K = 10%, M = 20%  
(4) H = 2.5%, J = 5%, K = 10%  
(\*) I<sub>rms</sub> value that leads to a ΔT of ≈ 20°C on the box surface > T<sub>BOX</sub> = T<sub>AMB</sub> + ΔT = 85°C + 20°C = 105°C

**Table 1 – Ratings & Part Number Reference cont.**

VDC	VAC	Cap Value (µF)	Dimensions in mm			Lead Spacing (S)	dV/dt (V/µs)	Max K <sub>v</sub> (V <sup>2</sup> /µs)	I <sub>pk</sub>	ESL	ESR max	I <sub>rms</sub> max (*)		R <sub>th</sub>	KEMET Internal Part Number	Customer Part Number
										Lead Length 2x 4 mm	at 100 kHz	at 100 kHz, 85°C	A <sub>rms</sub>			
			T	H	L					A <sub>pk</sub>	nH	mΩ	(°C/W)			
400	220	0.33	8.5	14.5	18.0	15.0	900	720,000	297	10	14.5	5.38	48	75MI3330(1)40(2)	R75MI3330(1)40(2)	
400	220	0.33	10.0	16.0	18.0	15.0	900	720,000	297	10	14.5	5.60	44	75MI3330(1)30(2)	R75MI3330(1)30(2)	
400	220	0.33	13.0	12.0	18.0	15.0	900	720,000	297	10	14.5	5.55	45	75MI3330(1)70(2)	R75MI3330(1)70(2)	
400	220	0.39	10.0	16.0	18.0	15.0	900	720,000	351	10	12.2	6.09	44	75MI3390(1)30(2)	R75MI3390(1)30(2)	
400	220	0.47	10.0	16.0	18.0	15.0	900	720,000	423	10	10.2	6.68	44	75MI3470(1)30(2)	R75MI3470(1)30(2)	
400	220	0.56	11.0	19.0	18.0	15.0	900	720,000	504	10	8.5	7.63	40	75MI3560(1)30(2)	R75MI3560(1)30(2)	
400	220	0.68	11.0	19.0	18.0	15.0	900	720,000	612	10	7.0	8.41	40	75MI3680(1)30(2)	R75MI3680(1)30(2)	
400	220	0.15	6.0	15.0	26.5	22.5	300	240,000	45	16	18.0	5.05	43	75MN3150(1)30(2)	R75MN3150(1)30(2)	
400	220	0.18	6.0	15.0	26.5	22.5	300	240,000	54	16	15.0	5.54	43	75MN3180(1)30(2)	R75MN3180(1)30(2)	
400	220	0.22	6.0	15.0	26.5	22.5	300	240,000	66	16	12.3	6.12	43	75MN3220(1)30(2)	R75MN3220(1)30(2)	
400	220	0.27	6.0	15.0	26.5	22.5	300	240,000	81	16	11.8	6.25	43	75MN3270(1)30(2)	R75MN3270(1)30(2)	
400	220	0.33	6.0	15.0	26.5	22.5	300	240,000	99	16	9.6	6.91	43	75MN3330(1)30(2)	R75MN3330(1)30(2)	
400	220	0.39	7.0	16.0	26.5	22.5	300	240,000	117	16	10.2	6.91	41	75MN3390(1)30(2)	R75MN3390(1)30(2)	
400	220	0.47	7.0	16.0	26.5	22.5	300	240,000	141	16	8.5	7.59	41	75MN3470(1)30(2)	R75MN3470(1)30(2)	
400	220	0.56	8.5	17.0	26.5	22.5	300	240,000	168	16	11.4	6.77	38	75MN3560(1)30(2)	R75MN3560(1)30(2)	
400	220	0.68	10.0	18.5	26.5	22.5	300	240,000	204	16	9.4	7.73	36	75MN3680(1)30(2)	R75MN3680(1)30(2)	
400	220	0.82	10.0	18.5	26.5	22.5	300	240,000	246	16	9.7	7.59	36	75MN3820(1)30(2)	R75MN3820(1)30(2)	
400	220	1	11.0	20.0	26.5	22.5	300	240,000	300	16	8.0	8.60	34	75MN4100(1)30(2)	R75MN4100(1)30(2)	
400	220	1.2	11.0	20.0	26.5	22.5	300	240,000	360	16	13.3	6.66	34	75MN4120(1)40(2)	R75MN4120(1)40(2)	
400	220	1.2	13.0	22.0	26.5	22.5	300	240,000	360	16	13.3	6.93	31	75MN4120(1)30(2)	R75MN4120(1)30(2)	
400	220	1.5	13.0	22.0	26.5	22.5	300	240,000	450	16	10.6	7.75	31	75MN4150(1)30(2)	R75MN4150(1)30(2)	
400	220	1.8	14.5	29.5	26.5	22.5	300	240,000	540	16	8.8	9.11	27	75MN4180(1)30(2)	R75MN4180(1)30(2)	
400	220	2.2	14.5	29.5	26.5	22.5	300	240,000	660	16	7.2	10.07	27	75MN4220(1)30(2)	R75MN4220(1)30(2)	
400	220	0.56	9.0	17.0	32.0	27.5	130	104,000	73	18	11.4	7.10	35	75MR3560(1)30(2)	R75MR3560(1)30(2)	
400	220	0.68	9.0	17.0	32.0	27.5	130	104,000	88	18	9.4	7.82	35	75MR3680(1)30(2)	R75MR3680(1)30(2)	
400	220	0.82	9.0	17.0	32.0	27.5	130	104,000	107	18	9.7	7.68	35	75MR3820(1)30(2)	R75MR3820(1)30(2)	
400	220	1	11.0	20.0	32.0	27.5	130	104,000	130	18	8.0	8.95	31	75MR4100(1)40(2)	R75MR4100(1)40(2)	
400	220	1.2	11.0	20.0	32.0	27.5	130	104,000	156	18	13.3	6.93	31	75MR4120(1)30(2)	R75MR4120(1)30(2)	
400	220	1.2	24.0	15.0	32.0	27.5	130	104,000	156	18	13.3	7.45	27	75MR4120(1)L3(2)	R75MR4120(1)L3(2)	
400	220	1.5	11.0	20.0	32.0	27.5	130	104,000	195	18	10.6	7.75	31	75MR4150(1)40(2)	R75MR4150(1)40(2)	
400	220	1.5	13.0	22.0	32.0	27.5	130	104,000	195	18	10.6	8.05	29	75MR4150(1)30(2)	R75MR4150(1)30(2)	
400	220	1.8	13.0	22.0	32.0	27.5	130	104,000	234	18	8.8	8.82	29	75MR4180(1)30(2)	R75MR4180(1)30(2)	
400	220	1.8	24.0	15.0	32.0	27.5	130	104,000	234	18	8.8	9.13	27	75MR4180(1)L3(2)	R75MR4180(1)L3(2)	
400	220	2.2	13.0	25.0	32.0	27.5	130	104,000	286	18	7.2	9.98	28	75MR4220(1)40(2)	R75MR4220(1)40(2)	
400	220	2.7	14.0	28.0	32.0	27.5	130	104,000	351	18	8.8	9.31	26	75MR4270(1)30(2)	R75MR4270(1)30(2)	
400	220	3.3	18.0	33.0	32.0	27.5	130	104,000	429	18	7.2	10.98	23	75MR4330(1)30(2)	R75MR4330(1)30(2)	
400	220	3.9	18.0	33.0	32.0	27.5	130	104,000	507	18	6.1	11.93	23	75MR4390(1)30(2)	R75MR4390(1)30(2)	
400	220	4.7	22.0	37.0	32.0	27.5	130	104,000	611	18	5.1	13.77	21	75MR4470(1)30(2)	R75MR4470(1)30(2)	
400	220	5.6	22.0	37.0	32.0	27.5	130	104,000	728	18	4.3	15.03	21	75MR4560(1)30(2)	R75MR4560(1)30(2)	
400	220	1.2	11.0	22.0	41.5	37.5	70	56,000	84	20	13.3	7.46	27	75MW4120(1)30(2)	R75MW4120(1)30(2)	
400	220	1.5	11.0	22.0	41.5	37.5	70	56,000	105	20	10.6	8.34	27	75MW4150(1)30(2)	R75MW4150(1)30(2)	
400	220	1.8	11.0	22.0	41.5	37.5	70	56,000	126	20	8.8	9.14	27	75MW4180(1)30(2)	R75MW4180(1)30(2)	
400	220	2.2	11.0	22.0	41.5	37.5	70	56,000	154	20	7.2	10.10	27	75MW4220(1)30(2)	R75MW4220(1)30(2)	
400	220	2.7	13.0	24.0	41.5	37.5	70	56,000	189	20	8.8	9.46	25	75MW4270(1)30(2)	R75MW4270(1)30(2)	
400	220	2.7	24.0	15.0	41.5	37.5	70	56,000	189	20	8.8	9.63	24	75MW4270(1)L3(2)	R75MW4270(1)L3(2)	
400	220	3.3	16.0	28.5	41.5	37.5	70	56,000	231	20	7.2	11.07	23	75MW4330(1)30(2)	R75MW4330(1)30(2)	
400	220	3.3	24.0	19.0	41.5	37.5	70	56,000	231	20	7.2	11.00	23	75MW4330(1)L3(2)	R75MW4330(1)L3(2)	
400	220	3.9	16.0	28.5	41.5	37.5	70	56,000	273	20	6.1	12.04	23	75MW4390(1)30(2)	R75MW4390(1)30(2)	
400	220	3.9	24.0	19.0	41.5	37.5	70	56,000	273	20	6.1	11.95	23	75MW4390(1)L3(2)	R75MW4390(1)L3(2)	
400	220	4.7	19.0	32.0	41.5	37.5	70	56,000	329	20	5.1	13.80	21	75MW4470(1)30(2)	R75MW4470(1)30(2)	
VDC	VAC	Cap Value	T	H	L	Lead Spacing (S)	dV/dt (V/µs)	Max K <sub>v</sub> (V <sup>2</sup> /µs)	A <sub>pk</sub>	ESL	ESR max	A <sub>rms</sub>	R <sub>th</sub>	KEMET Internal Part Number	Customer Part Number	
										Lead Length 2x 4 mm	at 100 kHz	at 100 kHz, 85°C				
			Dimensions						I <sub>pk</sub>	ESL	ESR max	I <sub>rms</sub> max (*)				

(1) Insert lead and packaging code. See Ordering Options Table for available options.  
(2) J = 5%, K = 10%, M = 20%  
(3) K = 10%, M = 20%  
(4) H = 2.5%, J = 5%, K = 10%  
(\*) I<sub>rms</sub> value that leads to a ΔT of ≈ 20°C on the box surface > T<sub>BOX</sub> = T<sub>AMB</sub> + ΔT = 85°C + 20°C = 105°C

**Table 1 – Ratings & Part Number Reference cont.**

VDC	VAC	Cap Value (µF)	Dimensions in mm			Lead Spacing (S)	dV/dt (V/µs)	Max K <sub>0</sub> (V <sup>2</sup> /µs)	I <sub>pk</sub>	ESL	ESR max	I <sub>rms</sub> max (*)		R <sub>th</sub>	KEMET Internal Part Number	Customer Part Number
										Lead Length 2x 4 mm	at 100 kHz	at 100 kHz, 85°C				
			A <sub>pk</sub>	nH	mΩ					A <sub>rms</sub>	(°C/W)					
400	220	5.6	19.0	32.0	41.5	37.5	70	56,000	392	20	4.3	15.06	21	75MW4560(1)30(2)	R75MW4560(1)30(2)	
400	220	6.8	20.0	40.0	41.5	37.5	70	56,000	476	20	7.0	12.32	19	75MW4680(1)20(2)	R75MW4680(1)20(2)	
400	220	8.2	20.0	40.0	41.5	37.5	70	56,000	574	20	5.8	13.53	19	75MW4820(1)30(2)	R75MW4820(1)30(2)	
400	220	10	24.0	44.0	41.5	37.5	70	56,000	700	20	4.8	15.59	17	75MW5100(1)30(2)	R75MW5100(1)30(2)	
400	220	12	30.0	45.0	41.5	37.5	70	56,000	840	20	4.0	17.71	16	75MW5120(1)20(2)	R75MW5120(1)20(2)	
400	220	15	30.0	45.0	41.5	37.5	70	56,000	1,050	20	3.2	19.80	16	75MW5150(1)30(2)	R75MW5150(1)30(2)	
630	220	0.001	3.5	7.5	7.2	5.0	500	630,000	1	7	4774.6	0.14	111	75PC1100(1)40(4)	R75PC1100(1)40(4)	
630	220	0.0012	3.5	7.5	7.2	5.0	500	630,000	1	7	3978.9	0.17	111	75PC1120(1)40(4)	R75PC1120(1)40(4)	
630	220	0.0015	3.5	7.5	7.2	5.0	500	630,000	1	7	3183.1	0.21	111	75PC1150(1)40(4)	R75PC1150(1)40(4)	
630	220	0.0018	3.5	7.5	7.2	5.0	500	630,000	1	7	2652.6	0.25	111	75PC1180(1)40(4)	R75PC1180(1)40(4)	
630	220	0.0022	3.5	7.5	7.2	5.0	500	630,000	1	7	2170.3	0.29	111	75PC1220(1)40(4)	R75PC1220(1)40(4)	
630	220	0.0027	3.5	7.5	7.2	5.0	500	630,000	1	7	1768.4	0.32	111	75PC1270(1)40(4)	R75PC1270(1)40(4)	
630	220	0.0033	3.5	7.5	7.2	5.0	500	630,000	2	7	1446.9	0.35	111	75PC1330(1)40(4)	R75PC1330(1)40(4)	
630	220	0.0039	4.5	9.5	7.2	5.0	600	756,000	2	7	1224.3	0.42	94	75PC1390(1)40(4)	R75PC1390(1)40(4)	
630	220	0.0047	4.5	9.5	7.2	5.0	600	756,000	3	7	1015.9	0.46	94	75PC1470(1)40(4)	R75PC1470(1)40(4)	
630	220	0.0056	4.5	9.5	7.2	5.0	600	756,000	3	7	852.6	0.50	94	75PC1560(1)40(4)	R75PC1560(1)40(4)	
630	220	0.0068	5.0	10.0	7.2	5.0	600	756,000	4	7	702.2	0.56	90	75PC1680(1)40(4)	R75PC1680(1)40(4)	
630	220	0.0082	5.0	10.0	7.2	5.0	600	756,000	5	7	582.3	0.62	90	75PC1820(1)40(4)	R75PC1820(1)40(4)	
630	220	0.01	6.0	11.0	7.2	5.0	600	756,000	6	7	477.5	0.71	82	75PC2100(1)40(4)	R75PC2100(1)40(4)	
630	220	0.012	6.0	11.0	7.2	5.0	600	756,000	7	7	397.9	0.78	82	75PC2120(1)40(4)	R75PC2120(1)40(4)	
630	220	0.015	7.2	13.0	7.2	5.0	600	756,000	9	7	318.3	0.93	73	75PC2150(1)40(4)	R75PC2150(1)40(4)	
630	220	0.018	7.2	13.0	7.2	5.0	600	756,000	11	7	265.3	1.02	73	75PC2180(1)40(4)	R75PC2180(1)40(4)	
630	220	0.01	4.0	9.0	10.0	7.5	600	756,000	6	8	79.6	1.38	88	75PD2100(1)B0(2)	R75PD2100(1)B0(2)	
630	220	0.012	4.0	9.0	10.0	7.5	600	756,000	7	8	92.8	1.57	88	75PD2120(1)B0(2)	R75PD2120(1)B0(2)	
630	220	0.015	5.0	10.5	10.0	7.5	600	756,000	9	8	74.3	1.86	78	75PD2150(1)B0(2)	R75PD2150(1)B0(2)	
630	220	0.018	5.0	10.5	10.0	7.5	600	756,000	11	8	61.9	2.03	78	75PD2180(1)B0(2)	R75PD2180(1)B0(2)	
630	220	0.022	6.0	12.0	10.5	7.5	600	756,000	13	8	50.6	2.39	69	75PD2220(1)A0(2)	R75PD2220(1)A0(2)	
630	220	0.027	6.0	12.0	10.5	7.5	600	756,000	16	8	41.3	2.64	69	75PD2270(1)A0(2)	R75PD2270(1)A0(2)	
630	250	0.0033	4.0	9.0	10.0	7.5	2,400	3,024,000	8	8	241.1	0.52	88	75PD1330(1)40(2)	R75PD1330(1)40(2)	
630	250	0.0039	4.0	9.0	10.0	7.5	2,400	3,024,000	9	8	204.0	0.61	88	75PD1390(1)40(2)	R75PD1390(1)40(2)	
630	250	0.0047	4.0	9.0	10.0	7.5	2,400	3,024,000	11	8	169.3	0.74	88	75PD1470(1)40(2)	R75PD1470(1)40(2)	
630	250	0.0056	4.0	9.0	10.0	7.5	2,400	3,024,000	13	8	142.1	0.88	88	75PD1560(1)40(2)	R75PD1560(1)40(2)	
630	250	0.0068	4.0	9.0	10.0	7.5	2,400	3,024,000	16	8	117.0	1.07	88	75PD1680(1)40(2)	R75PD1680(1)40(2)	
630	250	0.0082	4.0	9.0	10.0	7.5	2,400	3,024,000	20	8	97.0	1.29	88	75PD1820(1)40(2)	R75PD1820(1)40(2)	
630	250	0.01	5.0	10.5	10.0	7.5	2,400	3,024,000	24	8	79.6	1.57	78	75PD2100(1)40(2)	R75PD2100(1)40(2)	
630	250	0.012	5.0	10.5	10.0	7.5	2,400	3,024,000	29	8	92.8	1.66	78	75PD2120(1)40(2)	R75PD2120(1)40(2)	
630	250	0.015	6.0	12.0	10.5	7.5	2,400	3,024,000	36	8	74.3	1.97	69	75PD2150(1)30(2)	R75PD2150(1)30(2)	
630	250	0.018	6.0	12.0	10.5	7.5	2,400	3,024,000	43	8	61.9	2.16	69	75PD2180(1)30(2)	R75PD2180(1)30(2)	
630	250	0.001	4.0	9.0	13.0	10.0	2,000	2,520,000	2	9	795.8	0.16	79	75PF1100(1)01(2)	R75PF1100(1)01(2)	
630	250	0.0012	4.0	9.0	13.0	10.0	2,000	2,520,000	2	9	663.1	0.19	79	75PF1120(1)01(2)	R75PF1120(1)01(2)	
630	250	0.0015	4.0	9.0	13.0	10.0	2,000	2,520,000	3	9	530.5	0.24	79	75PF1150(1)01(2)	R75PF1150(1)01(2)	
630	250	0.0018	4.0	9.0	13.0	10.0	2,000	2,520,000	4	9	442.1	0.28	79	75PF1180(1)01(2)	R75PF1180(1)01(2)	
630	250	0.0022	4.0	9.0	13.0	10.0	2,000	2,520,000	4	9	361.7	0.35	79	75PF1220(1)01(2)	R75PF1220(1)01(2)	
630	250	0.0027	4.0	9.0	13.0	10.0	2,000	2,520,000	5	9	294.7	0.42	79	75PF1270(1)01(2)	R75PF1270(1)01(2)	
630	250	0.0033	4.0	9.0	13.0	10.0	2,000	2,520,000	7	9	241.1	0.52	79	75PF1330(1)01(2)	R75PF1330(1)01(2)	
630	250	0.0039	4.0	9.0	13.0	10.0	2,000	2,520,000	8	9	204.0	0.61	79	75PF1390(1)01(2)	R75PF1390(1)01(2)	
630	250	0.0047	4.0	9.0	13.0	10.0	2,000	2,520,000	9	9	169.3	0.74	79	75PF1470(1)00(2)	R75PF1470(1)00(2)	
630	250	0.0056	4.0	9.0	13.0	10.0	2,000	2,520,000	11	9	142.1	0.88	79	75PF1560(1)00(2)	R75PF1560(1)00(2)	
630	250	0.0068	4.0	9.0	13.0	10.0	2,000	2,520,000	14	9	117.0	1.07	79	75PF1680(1)00(2)	R75PF1680(1)00(2)	
630	250	0.0082	4.0	9.0	13.0	10.0	2,000	2,520,000	16	9	97.0	1.29	79	75PF1820(1)00(2)	R75PF1820(1)00(2)	
VDC	VAC	Cap Value	T	H	L	Lead Spacing (S)	dV/dt (V/µs)	Max K <sub>0</sub> (V <sup>2</sup> /µs)	A <sub>pk</sub>	Lead Length 2x 4 mm	at 100 kHz	A <sub>rms</sub>	R <sub>th</sub>	KEMET Internal Part Number	Customer Part Number	
			Dimensions						I <sub>pk</sub>	ESL	ESR max	I <sub>rms</sub> max (*)				

(1) Insert lead and packaging code. See Ordering Options Table for available options.  
(2) J = 5%, K = 10%, M = 20%  
(3) K = 10%, M = 20%  
(4) H = 2.5%, J = 5%, K = 10%  
(\*) I<sub>rms</sub> value that leads to a ΔT of ≈ 20°C on the box surface > T<sub>BOX</sub> = T<sub>AMB</sub> + ΔT = 85°C + 20°C = 105°C

**Table 1 – Ratings & Part Number Reference cont.**

VDC	VAC	Cap Value (µF)	Dimensions in mm			Lead Spacing (S)	dV/dt (V/µs)	Max K <sub>0</sub> (V <sup>2</sup> /µs)	I <sub>pk</sub>	ESL	ESR max	I <sub>rms</sub> max (*)	R <sub>th</sub>	KEMET Internal Part Number	Customer Part Number
										Lead Length 2x 4 mm	at 100 kHz	at 100 kHz, 85°C			
			A <sub>pk</sub>	nH	mΩ				A <sub>rms</sub>	(°C/W)					
630	250	0.01	4.0	9.0	13.0	10.0	2,000	2,520,000	20	9	79.6	1.57	79	75PF2100(1)30(2)	R75PF2100(1)30(2)
630	250	0.012	4.0	9.0	13.0	10.0	2,000	2,520,000	24	9	92.8	1.66	79	75PF2120(1)30(2)	R75PF2120(1)30(2)
630	250	0.015	4.0	9.0	13.0	10.0	2,000	2,520,000	30	9	74.3	1.85	79	75PF2150(1)40(2)	R75PF2150(1)40(2)
630	250	0.015	5.0	11.0	13.0	10.0	2,000	2,520,000	30	9	74.3	1.97	69	75PF2150(1)30(2)	R75PF2150(1)30(2)
630	250	0.018	4.0	9.0	13.0	10.0	2,000	2,520,000	36	9	61.9	2.03	79	75PF2180(1)40(2)	R75PF2180(1)40(2)
630	250	0.018	5.0	11.0	13.0	10.0	2,000	2,520,000	36	9	61.9	2.16	69	75PF2180(1)30(2)	R75PF2180(1)30(2)
630	250	0.022	5.0	11.0	13.0	10.0	2,000	2,520,000	44	9	50.6	2.39	69	75PF2220(1)40(2)	R75PF2220(1)40(2)
630	250	0.022	6.0	12.0	13.0	10.0	2,000	2,520,000	44	9	50.6	2.49	64	75PF2220(1)30(2)	R75PF2220(1)30(2)
630	250	0.027	5.0	11.0	13.0	10.0	2,000	2,520,000	54	9	41.3	2.65	69	75PF2270(1)40(2)	R75PF2270(1)40(2)
630	250	0.033	6.0	12.0	13.0	10.0	2,000	2,520,000	66	9	33.8	3.05	64	75PF2330(1)40(2)	R75PF2330(1)40(2)
630	250	0.039	6.0	12.0	13.0	10.0	2,000	2,520,000	78	9	28.6	3.31	64	75PF2390(1)40(2)	R75PF2390(1)40(2)
630	250	0.047	6.0	12.0	13.0	10.0	2,000	2,520,000	94	9	23.7	3.63	64	75PF2470(1)40(2)	R75PF2470(1)40(2)
630	250	0.027	5.0	11.0	18.0	15.0	1,000	1,260,000	27	10	41.3	2.84	60	75PI2270(1)00(2)	R75PI2270(1)00(2)
630	250	0.033	5.0	11.0	18.0	15.0	1,000	1,260,000	33	10	33.8	3.14	60	75PI2330(1)00(2)	R75PI2330(1)00(2)
630	250	0.039	5.0	11.0	18.0	15.0	1,000	1,260,000	39	10	28.6	3.41	60	75PI2390(1)30(2)	R75PI2390(1)30(2)
630	250	0.047	5.0	11.0	18.0	15.0	1,000	1,260,000	47	10	23.7	3.74	60	75PI2470(1)30(2)	R75PI2470(1)30(2)
630	250	0.056	5.0	11.0	18.0	15.0	1,000	1,260,000	56	10	28.4	3.42	60	75PI2560(1)30(2)	R75PI2560(1)30(2)
630	250	0.068	6.0	12.0	18.0	15.0	1,000	1,260,000	68	10	23.4	3.91	56	75PI2680(1)30(2)	R75PI2680(1)30(2)
630	250	0.082	6.0	12.0	18.0	15.0	1,000	1,260,000	82	10	19.4	4.29	56	75PI2820(1)30(2)	R75PI2820(1)30(2)
630	250	0.1	7.5	13.5	18.0	15.0	1,000	1,260,000	100	10	15.9	4.98	51	75PI3100(1)30(2)	R75PI3100(1)30(2)
630	250	0.1	9.0	12.5	18.0	15.0	1,000	1,260,000	100	10	15.9	5.03	50	75PI3100(1)70(2)	R75PI3100(1)70(2)
630	250	0.12	7.5	13.5	18.0	15.0	1,000	1,260,000	120	10	13.3	5.45	51	75PI3120(1)30(2)	R75PI3120(1)30(2)
630	250	0.12	9.0	12.5	18.0	15.0	1,000	1,260,000	120	10	13.3	5.51	50	75PI3120(1)70(2)	R75PI3120(1)70(2)
630	250	0.15	8.5	14.5	18.0	15.0	1,000	1,260,000	150	10	10.6	6.28	48	75PI3150(1)30(2)	R75PI3150(1)30(2)
630	250	0.15	13.0	12.0	18.0	15.0	1,000	1,260,000	150	10	10.6	6.48	45	75PI3150(1)70(2)	R75PI3150(1)70(2)
630	250	0.18	10.0	16.0	18.0	15.0	1,000	1,260,000	180	10	13.3	5.85	44	75PI3180(1)30(2)	R75PI3180(1)30(2)
630	250	0.18	13.0	12.0	18.0	15.0	1,000	1,260,000	180	10	13.3	5.80	45	75PI3180(1)70(2)	R75PI3180(1)70(2)
630	250	0.22	10.0	16.0	18.0	15.0	1,000	1,260,000	220	10	10.9	6.47	44	75PI3220(1)30(2)	R75PI3220(1)30(2)
630	250	0.27	11.0	19.0	18.0	15.0	1,000	1,260,000	270	10	17.7	5.30	40	75PI3270(1)30(2)	R75PI3270(1)30(2)
630	250	0.33	11.0	19.0	18.0	15.0	1,000	1,260,000	330	10	14.5	5.86	40	75PI3330(1)30(2)	R75PI3330(1)30(2)
630	250	0.39	11.0	19.0	18.0	15.0	1,000	1,260,000	390	10	12.2	6.37	40	75PI3390(1)30(2)	R75PI3390(1)30(2)
630	250	0.082	6.0	15.0	26.5	22.5	400	504,000	33	16	33.0	3.74	43	75PN2820(1)30(2)	R75PN2820(1)30(2)
630	250	0.1	6.0	15.0	26.5	22.5	400	504,000	40	16	27.1	4.13	43	75PN3100(1)30(2)	R75PN3100(1)30(2)
630	250	0.12	6.0	15.0	26.5	22.5	400	504,000	48	16	22.5	4.52	43	75PN3120(1)30(2)	R75PN3120(1)30(2)
630	250	0.15	6.0	15.0	26.5	22.5	400	504,000	60	16	18.0	5.05	43	75PN3150(1)30(2)	R75PN3150(1)30(2)
630	250	0.18	7.0	16.0	26.5	22.5	400	504,000	72	16	15.0	5.69	41	75PN3180(1)30(2)	R75PN3180(1)30(2)
630	250	0.22	7.0	16.0	26.5	22.5	400	504,000	88	16	12.3	6.30	41	75PN3220(1)30(2)	R75PN3220(1)30(2)
630	250	0.27	8.5	17.0	26.5	22.5	400	504,000	108	16	11.8	6.65	38	75PN3270(1)30(2)	R75PN3270(1)30(2)
630	250	0.33	10.0	18.5	26.5	22.5	400	504,000	132	16	9.6	7.61	36	75PN3330(1)30(2)	R75PN3330(1)30(2)
630	250	0.39	10.0	18.5	26.5	22.5	400	504,000	156	16	10.2	7.40	36	75PN3390(1)30(2)	R75PN3390(1)30(2)
630	250	0.47	11.0	20.0	26.5	22.5	400	504,000	188	16	8.5	8.34	34	75PN3470(1)30(2)	R75PN3470(1)30(2)
630	250	0.56	11.0	20.0	26.5	22.5	400	504,000	224	16	11.4	7.20	34	75PN3560(1)30(2)	R75PN3560(1)30(2)
630	250	0.68	13.0	22.0	26.5	22.5	400	504,000	272	16	9.4	8.25	31	75PN3680(1)30(2)	R75PN3680(1)30(2)
630	250	0.82	13.0	22.0	26.5	22.5	400	504,000	328	16	9.7	8.10	31	75PN3820(1)30(2)	R75PN3820(1)30(2)
630	250	1	14.5	29.5	26.5	22.5	400	504,000	400	16	8.0	9.60	27	75PN4100(1)30(2)	R75PN4100(1)30(2)
630	250	1.2	14.5	29.5	26.5	22.5	400	504,000	480	16	13.3	7.44	27	75PN4120(1)30(2)	R75PN4120(1)30(2)
630	250	0.39	9.0	17.0	32.0	27.5	210	264,600	82	18	10.2	7.49	35	75PR3390(1)30(2)	R75PR3390(1)30(2)
630	250	0.47	9.0	17.0	32.0	27.5	210	264,600	99	18	8.5	8.22	35	75PR3470(1)40(2)	R75PR3470(1)40(2)
630	250	0.56	11.0	20.0	32.0	27.5	210	264,600	118	18	11.4	7.49	31	75PR3560(1)30(2)	R75PR3560(1)30(2)
630	250	0.68	11.0	20.0	32.0	27.5	210	264,600	143	18	9.4	8.25	31	75PR3680(1)30(2)	R75PR3680(1)30(2)

VDC	VAC	Cap Value	T	H	L	Lead Spacing (S)	dV/dt (V/µs)	Max K <sub>0</sub> (V <sup>2</sup> /µs)	A <sub>pk</sub>	nH	mΩ	A <sub>rms</sub>	R <sub>th</sub>	KEMET Internal Part Number	Customer Part Number
										Lead Length 2x 4 mm	at 100 kHz	at 100 kHz, 85°C			
			Dimensions						I <sub>pk</sub>	ESL	ESR max	I <sub>rms</sub> max (*)	(°C/W)		

(1) Insert lead and packaging code. See Ordering Options Table for available options.  
(2) J = 5%, K = 10%, M = 20%  
(3) K = 10%, M = 20%  
(4) H = 2.5%, J = 5%, K = 10%  
(\*) I<sub>rms</sub> value that leads to a ΔT of ≈ 20°C on the box surface > T<sub>BOX</sub> = T<sub>AMB</sub> + ΔT = 85°C + 20°C = 105°C

**Table 1 – Ratings & Part Number Reference cont.**

VDC	VAC	Cap Value (µF)	Dimensions in mm			Lead Spacing (S)	dV/dt (V/µs)	Max K <sub>0</sub> (V <sup>2</sup> /µs)	I <sub>pk</sub>	ESL	ESR max	I <sub>rms</sub> max (*)		R <sub>th</sub>	KEMET Internal Part Number	Customer Part Number
										Lead Length 2x 4 mm	at 100 kHz	at 100 kHz, 85°C	(°C/W)			
			T	H	L					A <sub>pk</sub>	nH	mΩ	A <sub>rms</sub>			
630	250	0.68	24.0	15.0	32.0	27.5	210	264,600	143	18	9.4	8.87	27	75PR3680(1)L3(2)	R75PR3680(1)L3(2)	
630	250	0.82	13.0	22.0	32.0	27.5	210	264,600	172	18	9.7	8.42	29	75PR3820(1)30(2)	R75PR3820(1)30(2)	
630	250	1	13.0	22.0	32.0	27.5	210	264,600	210	18	8.0	9.30	29	75PR4100(1)30(2)	R75PR4100(1)30(2)	
630	250	1	24.0	15.0	32.0	27.5	210	264,600	210	18	8.0	9.62	27	75PR4100(1)L3(2)	R75PR4100(1)L3(2)	
630	250	1.2	14.0	28.0	32.0	27.5	210	264,600	252	18	13.3	7.60	26	75PR4120(1)40(2)	R75PR4120(1)40(2)	
630	250	1.5	14.0	28.0	32.0	27.5	210	264,600	315	18	10.6	8.50	26	75PR4150(1)30(2)	R75PR4150(1)30(2)	
630	250	1.8	18.0	33.0	32.0	27.5	210	264,600	378	18	8.8	9.93	23	75PR4180(1)30(2)	R75PR4180(1)30(2)	
630	250	2.2	18.0	33.0	32.0	27.5	210	264,600	462	18	7.2	10.98	23	75PR4220(1)30(2)	R75PR4220(1)30(2)	
630	250	2.7	22.0	37.0	32.0	27.5	210	264,600	567	18	8.8	10.44	21	75PR4270(1)30(2)	R75PR4270(1)30(2)	
630	250	3.3	22.0	37.0	32.0	27.5	210	264,600	693	18	7.2	11.54	21	75PR4330(1)30(2)	R75PR4330(1)30(2)	
630	250	0.68	11.0	22.0	41.5	37.5	90	113,400	61	20	9.4	8.88	27	75PW3680(1)30(2)	R75PW3680(1)30(2)	
630	250	0.82	11.0	22.0	41.5	37.5	90	113,400	74	20	9.7	8.72	27	75PW3820(1)30(2)	R75PW3820(1)30(2)	
630	250	1	11.0	22.0	41.5	37.5	90	113,400	90	20	8.0	9.63	27	75PW4100(1)30(2)	R75PW4100(1)30(2)	
630	250	1.2	13.0	24.0	41.5	37.5	90	113,400	108	20	13.3	7.73	25	75PW4120(1)30(2)	R75PW4120(1)30(2)	
630	250	1.5	13.0	24.0	41.5	37.5	90	113,400	135	20	10.6	8.64	25	75PW4150(1)30(2)	R75PW4150(1)30(2)	
630	250	1.5	24.0	15.0	41.5	37.5	90	113,400	135	20	10.6	8.79	24	75PW4150(1)L3(2)	R75PW4150(1)L3(2)	
630	250	1.8	16.0	28.5	41.5	37.5	90	113,400	162	20	8.8	10.02	23	75PW4180(1)30(2)	R75PW4180(1)30(2)	
630	250	2.2	16.0	28.5	41.5	37.5	90	113,400	198	20	7.2	11.07	23	75PW4220(1)30(2)	R75PW4220(1)30(2)	
630	250	2.2	24.0	19.0	41.5	37.5	90	113,400	198	20	7.2	11.00	23	75PW4220(1)L3(2)	R75PW4220(1)L3(2)	
630	250	2.7	19.0	32.0	41.5	37.5	90	113,400	243	20	8.8	10.46	21	75PW4270(1)30(2)	R75PW4270(1)30(2)	
630	250	3.3	19.0	32.0	41.5	37.5	90	113,400	297	20	7.2	11.56	21	75PW4330(1)30(2)	R75PW4330(1)30(2)	
630	250	3.9	20.0	40.0	41.5	37.5	90	113,400	351	20	6.1	13.20	19	75PW4390(1)30(2)	R75PW4390(1)30(2)	
630	250	4.7	20.0	40.0	41.5	37.5	90	113,400	423	20	5.1	14.49	19	75PW4470(1)30(2)	R75PW4470(1)30(2)	
630	250	5.6	24.0	44.0	41.5	37.5	90	113,400	504	20	4.3	16.50	17	75PW4560(1)30(2)	R75PW4560(1)30(2)	
630	250	6.8	30.0	45.0	41.5	37.5	90	113,400	612	20	7.0	13.33	16	75PW4680(1)20(2)	R75PW4680(1)20(2)	
630	250	8.2	30.0	45.0	41.5	37.5	90	113,400	738	20	5.8	14.64	16	75PW4820(1)30(2)	R75PW4820(1)30(2)	
1000	300	0.0056	4.0	9.0	13.0	10.0	2,000	4,000,000	11	9	142.1	1.06	79	75QF1560(1)40(2)	R75QF1560(1)40(2)	
1000	300	0.0068	4.0	9.0	13.0	10.0	2,000	4,000,000	14	9	117.0	1.28	79	75QF1680(1)40(2)	R75QF1680(1)40(2)	
1000	300	0.0082	4.0	9.0	13.0	10.0	2,000	4,000,000	16	9	97.0	1.55	79	75QF1820(1)40(2)	R75QF1820(1)40(2)	
1000	300	0.01	5.0	11.0	13.0	10.0	2,000	4,000,000	20	9	79.6	1.88	69	75QF2100(1)40(2)	R75QF2100(1)40(2)	
1000	300	0.012	5.0	11.0	13.0	10.0	2,000	4,000,000	24	9	92.8	1.77	69	75QF2120(1)40(2)	R75QF2120(1)40(2)	
1000	300	0.015	6.0	12.0	13.0	10.0	2,000	4,000,000	30	9	74.3	2.05	64	75QF2150(1)40(2)	R75QF2150(1)40(2)	
1000	300	0.018	6.0	12.0	13.0	10.0	2,000	4,000,000	36	9	61.9	2.25	64	75QF2180(1)40(2)	R75QF2180(1)40(2)	
1000	300	0.01	5.0	11.0	18.0	15.0	2,000	4,000,000	20	10	79.6	1.88	60	75QI2100(1)00(2)	R75QI2100(1)00(2)	
1000	300	0.012	5.0	11.0	18.0	15.0	2,000	4,000,000	24	10	92.8	1.89	60	75QI2120(1)00(2)	R75QI2120(1)00(2)	
1000	300	0.015	5.0	11.0	18.0	15.0	2,000	4,000,000	30	10	74.3	2.11	60	75QI2150(1)00(2)	R75QI2150(1)00(2)	
1000	300	0.018	5.0	11.0	18.0	15.0	2,000	4,000,000	36	10	61.9	2.32	60	75QI2180(1)00(2)	R75QI2180(1)00(2)	
1000	300	0.022	5.0	11.0	18.0	15.0	2,000	4,000,000	44	10	50.6	2.56	60	75QI2220(1)00(2)	R75QI2220(1)00(2)	
1000	300	0.027	6.0	12.0	18.0	15.0	2,000	4,000,000	54	10	41.3	2.94	56	75QI2270(1)00(2)	R75QI2270(1)00(2)	
1000	300	0.033	6.0	12.0	18.0	15.0	2,000	4,000,000	66	10	33.8	3.25	56	75QI2330(1)00(2)	R75QI2330(1)00(2)	
1000	300	0.039	6.0	12.0	18.0	15.0	2,000	4,000,000	78	10	28.6	3.54	56	75QI2390(1)00(2)	R75QI2390(1)00(2)	
1000	300	0.047	7.5	13.5	18.0	15.0	2,000	4,000,000	94	10	23.7	4.08	51	75QI2470(1)00(2)	R75QI2470(1)00(2)	
1000	300	0.047	9.0	12.5	18.0	15.0	2,000	4,000,000	94	10	23.7	4.12	50	75QI2470(1)60(2)	R75QI2470(1)60(2)	
1000	300	0.056	8.5	14.5	18.0	15.0	2,000	4,000,000	112	10	28.4	3.84	48	75QI2560(1)00(2)	R75QI2560(1)00(2)	
1000	300	0.056	9.0	12.5	18.0	15.0	2,000	4,000,000	112	10	28.4	3.77	50	75QI2560(1)60(2)	R75QI2560(1)60(2)	
1000	300	0.068	8.5	14.5	18.0	15.0	2,000	4,000,000	136	10	23.4	4.23	48	75QI2680(1)00(2)	R75QI2680(1)00(2)	
1000	300	0.068	13.0	12.0	18.0	15.0	2,000	4,000,000	136	10	23.4	4.36	45	75QI2680(1)60(2)	R75QI2680(1)60(2)	
1000	300	0.082	10.0	16.0	18.0	15.0	2,000	4,000,000	164	10	19.4	4.83	44	75QI2820(1)00(2)	R75QI2820(1)00(2)	
1000	300	0.1	10.0	16.0	18.0	15.0	2,000	4,000,000	200	10	15.9	5.34	44	75QI3100(1)30(2)	R75QI3100(1)30(2)	
1000	300	0.1	11.0	19.0	18.0	15.0	2,000	4,000,000	200	10	15.9	5.59	40	75QI3100(1)00(2)	R75QI3100(1)00(2)	
VDC	VAC	Cap Value	T	H	L	Lead Spacing (S)	dV/dt (V/µs)	Max K <sub>0</sub> (V <sup>2</sup> /µs)	A <sub>pk</sub>	Lead Length 2x 4 mm	at 100 kHz	A <sub>rms</sub>	(°C/W)	KEMET Internal Part Number	Customer Part Number	
									I <sub>pk</sub>	ESL	ESR max	I <sub>rms</sub> max (*)				

(1) Insert lead and packaging code. See Ordering Options Table for available options.  
(2) J = 5%, K = 10%, M = 20%  
(3) K = 10%, M = 20%  
(4) H = 2.5%, J = 5%, K = 10%  
(\*) I<sub>rms</sub> value that leads to a ΔT of ≈ 20°C on the box surface > T<sub>BOX</sub> = T<sub>AMB</sub> + ΔT = 85°C + 20°C = 105°C

**Table 1 – Ratings & Part Number Reference cont.**

VDC	VAC	Cap Value (µF)	Dimensions in mm			Lead Spacing (S)	dV/dt (V/µs)	Max K <sub>0</sub> (V <sup>2</sup> /µs)	I <sub>pk</sub>	ESL	ESR max	I <sub>rms</sub> max (*)	R <sub>th</sub>	KEMET Internal Part Number	Customer Part Number
										Lead Length 2x 4 mm	at 100 kHz	at 100 kHz, 85°C			
			T	H	L				A <sub>pk</sub>	nH	mΩ	A <sub>rms</sub>	(°C/W)		
1000	300	0.12	11.0	19.0	18.0	15.0	2,000	4,000,000	240	10	13.3	6.12	40	75Q13120(1)00(2)	R75Q13120(1)00(2)
1000	300	0.15	11.0	19.0	18.0	15.0	2,000	4,000,000	300	10	10.6	6.84	40	75Q13150(1)00(2)	R75Q13150(1)00(2)
1000	300	0.033	6.0	15.0	26.5	22.5	800	1,600,000	26	16	72.3	2.52	43	75QN2330(1)00(2)	R75QN2330(1)00(2)
1000	300	0.047	6.0	15.0	26.5	22.5	800	1,600,000	38	16	50.8	3.01	43	75QN2470(1)00(2)	R75QN2470(1)00(2)
1000	300	0.056	6.0	15.0	26.5	22.5	800	1,600,000	45	16	48.3	3.09	43	75QN2560(1)00(2)	R75QN2560(1)00(2)
1000	300	0.068	6.0	15.0	26.5	22.5	800	1,600,000	54	16	39.8	3.40	43	75QN2680(1)00(2)	R75QN2680(1)00(2)
1000	300	0.082	7.0	16.0	26.5	22.5	800	1,600,000	66	16	33.0	3.84	41	75QN2820(1)00(2)	R75QN2820(1)00(2)
1000	300	0.1	7.0	16.0	26.5	22.5	800	1,600,000	80	16	27.1	4.24	41	75QN3100(1)00(2)	R75QN3100(1)00(2)
1000	300	0.12	8.5	17.0	26.5	22.5	800	1,600,000	96	16	22.5	4.81	38	75QN3120(1)00(2)	R75QN3120(1)00(2)
1000	300	0.15	10.0	18.5	26.5	22.5	800	1,600,000	120	16	18.0	5.57	36	75QN3150(1)00(2)	R75QN3150(1)00(2)
1000	300	0.18	10.0	18.5	26.5	22.5	800	1,600,000	144	16	15.0	6.10	36	75QN3180(1)00(2)	R75QN3180(1)00(2)
1000	300	0.22	11.0	20.0	26.5	22.5	800	1,600,000	176	16	12.3	6.92	34	75QN3220(1)00(2)	R75QN3220(1)00(2)
1000	300	0.27	11.0	20.0	26.5	22.5	800	1,600,000	216	16	11.8	7.07	34	75QN3270(1)00(2)	R75QN3270(1)00(2)
1000	300	0.33	13.0	22.0	26.5	22.5	800	1,600,000	264	16	9.6	8.13	31	75QN3330(1)00(2)	R75QN3330(1)00(2)
1000	300	0.47	14.5	29.5	26.5	22.5	800	1,600,000	376	16	8.5	9.31	27	75QN3470(1)00(2)	R75QN3470(1)00(2)
1000	300	0.56	14.5	29.5	26.5	22.5	800	1,600,000	448	16	11.4	8.03	27	75QN3560(1)00(2)	R75QN3560(1)00(2)
1000	300	0.15	9.0	17.0	32.0	27.5	350	700,000	53	18	18.0	5.63	35	75QR3150(1)00(2)	R75QR3150(1)00(2)
1000	300	0.18	9.0	17.0	32.0	27.5	350	700,000	63	18	15.0	6.17	35	75QR3180(1)00(2)	R75QR3180(1)00(2)
1000	300	0.22	11.0	20.0	32.0	27.5	350	700,000	77	18	12.3	7.20	31	75QR3220(1)10(2)	R75QR3220(1)10(2)
1000	300	0.27	11.0	20.0	32.0	27.5	350	700,000	95	18	11.8	7.35	31	75QR3270(1)00(2)	R75QR3270(1)00(2)
1000	300	0.33	11.0	20.0	32.0	27.5	350	700,000	116	18	9.6	8.13	31	75QR3330(1)30(2)	R75QR3330(1)30(2)
1000	300	0.33	13.0	22.0	32.0	27.5	350	700,000	116	18	9.6	8.44	29	75QR3330(1)00(2)	R75QR3330(1)00(2)
1000	300	0.33	24.0	15.0	32.0	27.5	350	700,000	116	18	9.6	8.74	27	75QR3330(1)L0(2)	R75QR3330(1)L0(2)
1000	300	0.39	13.0	22.0	32.0	27.5	350	700,000	137	18	10.2	8.21	29	75QR3390(1)00(2)	R75QR3390(1)00(2)
1000	300	0.39	24.0	15.0	32.0	27.5	350	700,000	137	18	10.2	8.50	27	75QR3390(1)L0(2)	R75QR3390(1)L0(2)
1000	300	0.47	13.0	25.0	32.0	27.5	350	700,000	165	18	8.5	9.23	28	75QR3470(1)10(2)	R75QR3470(1)10(2)
1000	300	0.56	14.0	28.0	32.0	27.5	350	700,000	196	18	11.4	8.21	26	75QR3560(1)10(2)	R75QR3560(1)10(2)
1000	300	0.68	18.0	33.0	32.0	27.5	350	700,000	238	18	9.4	9.65	23	75QR3680(1)00(2)	R75QR3680(1)00(2)
1000	300	0.82	18.0	33.0	32.0	27.5	350	700,000	287	18	9.7	9.48	23	75QR3820(1)00(2)	R75QR3820(1)00(2)
1000	300	1	18.0	33.0	32.0	27.5	350	700,000	350	18	8.0	10.47	23	75QR4100(1)00(2)	R75QR4100(1)00(2)
1000	300	1.2	22.0	37.0	32.0	27.5	350	700,000	420	18	13.3	8.52	21	75QR4120(1)00(2)	R75QR4120(1)00(2)
1000	300	1.5	22.0	37.0	32.0	27.5	350	700,000	525	18	10.6	9.53	21	75QR4150(1)00(2)	R75QR4150(1)00(2)
1000	300	0.27	11.0	22.0	41.5	37.5	200	400,000	54	20	11.8	7.91	27	75QW3270(1)00(2)	R75QW3270(1)00(2)
1000	300	0.33	11.0	22.0	41.5	37.5	200	400,000	66	20	9.6	8.75	27	75QW3330(1)00(2)	R75QW3330(1)00(2)
1000	300	0.39	11.0	22.0	41.5	37.5	200	400,000	78	20	10.2	8.50	27	75QW3390(1)00(2)	R75QW3390(1)00(2)
1000	300	0.47	11.0	22.0	41.5	37.5	200	400,000	94	20	8.5	9.34	27	75QW3470(1)00(2)	R75QW3470(1)00(2)
1000	300	0.56	13.0	24.0	41.5	37.5	200	400,000	112	20	11.4	8.35	25	75QW3560(1)00(2)	R75QW3560(1)00(2)
1000	300	0.68	13.0	24.0	41.5	37.5	200	400,000	136	20	9.4	9.20	25	75QW3680(1)00(2)	R75QW3680(1)00(2)
1000	300	0.68	24.0	15.0	41.5	37.5	200	400,000	136	20	9.4	9.36	24	75QW3680(1)L0(2)	R75QW3680(1)L0(2)
1000	300	0.82	16.0	28.5	41.5	37.5	200	400,000	164	20	9.7	9.56	23	75QW3820(1)00(2)	R75QW3820(1)00(2)
1000	300	0.82	24.0	19.0	41.5	37.5	200	400,000	164	20	9.7	9.49	23	75QW3820(1)L0(2)	R75QW3820(1)L0(2)
1000	300	1	16.0	28.5	41.5	37.5	200	400,000	200	20	8.0	10.56	23	75QW4100(1)00(2)	R75QW4100(1)00(2)
1000	300	1.2	19.0	32.0	41.5	37.5	200	400,000	240	20	13.3	8.54	21	75QW4120(1)00(2)	R75QW4120(1)00(2)
1000	300	1.5	19.0	32.0	41.5	37.5	200	400,000	300	20	10.6	9.55	21	75QW4150(1)00(2)	R75QW4150(1)00(2)
1000	300	1.8	20.0	40.0	41.5	37.5	200	400,000	360	20	8.8	10.98	19	75QW4180(1)00(2)	R75QW4180(1)00(2)
1000	300	2.2	20.0	40.0	41.5	37.5	200	400,000	440	20	7.2	12.14	19	75QW4220(1)00(2)	R75QW4220(1)00(2)
1000	300	2.2	24.0	44.0	41.5	37.5	200	400,000	440	20	7.2	12.67	17	75QW4220(1)30(2)	R75QW4220(1)30(2)
1000	300	2.7	24.0	44.0	41.5	37.5	200	400,000	540	20	8.8	11.46	17	75QW4270(1)00(2)	R75QW4270(1)00(2)
1000	300	3.3	30.0	45.0	41.5	37.5	200	400,000	660	20	7.2	13.13	16	75QW4330(1)00(2)	R75QW4330(1)00(2)
1000	300	3.9	30.0	45.0	41.5	37.5	200	400,000	780	20	6.1	14.28	16	75QW4390(1)00(2)	R75QW4390(1)00(2)
VDC	VAC	Cap Value	T	H	L	Lead Spacing (S)	dV/dt (V/µs)	Max K <sub>0</sub> (V <sup>2</sup> /µs)	A <sub>pk</sub>	Lead Length 2x 4 mm	at 100 kHz	A <sub>rms</sub>	R <sub>th</sub>	KEMET Internal Part Number	Customer Part Number
									I <sub>pk</sub>	ESL	ESR max	I <sub>rms</sub> max (*)			

(1) Insert lead and packaging code. See Ordering Options Table for available options.  
(2) J = 5%, K = 10%, M = 20%  
(3) K = 10%, M = 20%  
(4) H = 2.5%, J = 5%, K = 10%  
(\*) I<sub>rms</sub> value that leads to a ΔT of ≈ 20°C on the box surface > T<sub>BOX</sub> = T<sub>AMB</sub> + ΔT = 85°C + 20°C = 105°C

**Table 1 – Ratings & Part Number Reference cont.**

VDC	VAC	Cap Value (µF)	Dimensions in mm			Lead Spacing (S)	dV/dt (V/µs)	Max K <sub>0</sub> (V <sup>2</sup> /µs)	I <sub>pk</sub>	ESL	ESR max	I <sub>rms</sub> max (*)	R <sub>th</sub>	KEMET Internal Part Number	Customer Part Number
										Lead Length 2x 4 mm	at 100 kHz	at 100 kHz, 85°C			
			T	H	L				A <sub>pk</sub>	nH	mΩ	A <sub>rms</sub>	(°C/W)		
1000	400	0.00022	3.0	8.0	10.0	7.5	4,000	8,000,000	1	8	3617.2	0.06	98	75QD0220(1)30(2)	R75QD0220(1)30(2)
1000	400	0.00027	3.0	8.0	10.0	7.5	4,000	8,000,000	1	8	2947.3	0.07	98	75QD0270(1)30(2)	R75QD0270(1)30(2)
1000	400	0.00033	3.0	8.0	10.0	7.5	4,000	8,000,000	1	8	2411.4	0.08	98	75QD0330(1)30(2)	R75QD0330(1)30(2)
1000	400	0.00039	3.0	8.0	10.0	7.5	4,000	8,000,000	2	8	2040.4	0.10	98	75QD0390(1)30(2)	R75QD0390(1)30(2)
1000	400	0.00047	3.0	8.0	10.0	7.5	4,000	8,000,000	2	8	1693.1	0.12	98	75QD0470(1)30(2)	R75QD0470(1)30(2)
1000	400	0.00056	3.0	8.0	10.0	7.5	4,000	8,000,000	2	8	1421.0	0.14	98	75QD0560(1)30(2)	R75QD0560(1)30(2)
1000	400	0.00068	3.0	8.0	10.0	7.5	4,000	8,000,000	3	8	1170.3	0.17	98	75QD0680(1)30(2)	R75QD0680(1)30(2)
1000	400	0.00082	3.0	8.0	10.0	7.5	4,000	8,000,000	3	8	970.5	0.21	98	75QD0820(1)30(2)	R75QD0820(1)30(2)
1000	400	0.001	3.0	8.0	10.0	7.5	4,000	8,000,000	4	8	795.8	0.25	98	75QD1100(1)30(2)	R75QD1100(1)30(2)
1000	400	0.0012	4.0	9.0	10.0	7.5	4,000	8,000,000	5	8	663.1	0.30	88	75QD1120(1)30(2)	R75QD1120(1)30(2)
1000	400	0.0015	4.0	9.0	10.0	7.5	4,000	8,000,000	6	8	530.5	0.38	88	75QD1150(1)30(2)	R75QD1150(1)30(2)
1000	400	0.0018	4.0	9.0	10.0	7.5	4,000	8,000,000	7	8	442.1	0.45	88	75QD1180(1)30(2)	R75QD1180(1)30(2)
1000	400	0.0022	4.0	9.0	10.0	7.5	4,000	8,000,000	9	8	361.7	0.55	88	75QD1220(1)30(2)	R75QD1220(1)30(2)
1000	400	0.0027	4.0	9.0	10.0	7.5	4,000	8,000,000	11	8	294.7	0.68	88	75QD1270(1)30(2)	R75QD1270(1)30(2)
1000	400	0.0033	4.0	9.0	10.0	7.5	4,000	8,000,000	13	8	241.1	0.83	88	75QD1330(1)30(2)	R75QD1330(1)30(2)
1000	400	0.0039	5.0	10.5	10.0	7.5	4,000	8,000,000	16	8	204.0	0.98	78	75QD1390(1)30(2)	R75QD1390(1)30(2)
1000	400	0.0047	5.0	10.5	10.0	7.5	4,000	8,000,000	19	8	169.3	1.18	78	75QD1470(1)30(2)	R75QD1470(1)30(2)
1000	400	0.0056	5.0	10.5	10.0	7.5	4,000	8,000,000	22	8	142.1	1.34	78	75QD1560(1)30(2)	R75QD1560(1)30(2)
1000	400	0.0068	6.0	12.0	10.5	7.5	4,000	8,000,000	27	8	117.0	1.57	69	75QD1680(1)30(2)	R75QD1680(1)30(2)
1000	400	0.0082	6.0	12.0	10.5	7.5	4,000	8,000,000	33	8	97.0	1.72	69	75QD1820(1)30(2)	R75QD1820(1)30(2)
1250	450	0.0022	4.0	9.0	13.0	10.0	6,000	15,000,000	13	9	361.7	0.62	79	75RF1220(1)40(2)	R75RF1220(1)40(2)
1250	450	0.0027	4.0	9.0	13.0	10.0	6,000	15,000,000	16	9	294.7	0.76	79	75RF1270(1)40(2)	R75RF1270(1)40(2)
1250	450	0.0033	4.0	9.0	13.0	10.0	6,000	15,000,000	20	9	241.1	0.93	79	75RF1330(1)40(2)	R75RF1330(1)40(2)
1250	450	0.0047	5.0	11.0	13.0	10.0	6,000	15,000,000	28	9	169.3	1.31	69	75RF1470(1)40(2)	R75RF1470(1)40(2)
1250	450	0.0056	5.0	11.0	13.0	10.0	6,000	15,000,000	34	9	142.1	1.43	69	75RF1560(1)40(2)	R75RF1560(1)40(2)
1250	450	0.0068	6.0	12.0	13.0	10.0	6,000	15,000,000	41	9	117.0	1.64	64	75RF1680(1)40(2)	R75RF1680(1)40(2)
1250	450	0.0082	6.0	12.0	13.0	10.0	6,000	15,000,000	49	9	97.0	1.80	64	75RF1820(1)40(2)	R75RF1820(1)40(2)
1250	450	0.01	6.0	12.0	13.0	10.0	6,000	15,000,000	60	9	79.6	1.98	64	75RF2100(1)40(2)	R75RF2100(1)40(2)
1250	600	0.0068	5.0	11.0	18.0	15.0	3,300	8,250,000	22	10	117.0	1.68	60	75RI1680(1)30(2)	R75RI1680(1)30(2)
1250	600	0.0082	5.0	11.0	18.0	15.0	3,300	8,250,000	27	10	97.0	1.85	60	75RI1820(1)30(2)	R75RI1820(1)30(2)
1250	600	0.01	5.0	11.0	18.0	15.0	3,300	8,250,000	33	10	79.6	2.04	60	75RI2100(1)30(2)	R75RI2100(1)30(2)
1250	600	0.012	6.0	12.0	18.0	15.0	3,300	8,250,000	40	10	66.3	2.32	56	75RI2120(1)30(2)	R75RI2120(1)30(2)
1250	600	0.015	6.0	12.0	18.0	15.0	3,300	8,250,000	50	10	53.1	2.60	56	75RI2150(1)30(2)	R75RI2150(1)30(2)
1250	600	0.018	7.5	13.5	18.0	15.0	3,300	8,250,000	59	10	44.2	2.99	51	75RI2180(1)30(2)	R75RI2180(1)30(2)
1250	600	0.022	7.5	13.5	18.0	15.0	3,300	8,250,000	73	10	36.2	3.30	51	75RI2220(1)30(2)	R75RI2220(1)30(2)
1250	600	0.022	9.0	12.5	18.0	15.0	3,300	8,250,000	73	10	36.2	3.34	50	75RI2220(1)70(2)	R75RI2220(1)70(2)
1250	600	0.027	8.5	14.5	18.0	15.0	3,300	8,250,000	89	10	29.5	3.77	48	75RI2270(1)30(2)	R75RI2270(1)30(2)
1250	600	0.027	13.0	12.0	18.0	15.0	3,300	8,250,000	89	10	29.5	3.89	45	75RI2270(1)70(2)	R75RI2270(1)70(2)
1250	600	0.033	10.0	16.0	18.0	15.0	3,300	8,250,000	109	10	24.1	4.34	44	75RI2330(1)30(2)	R75RI2330(1)30(2)
1250	600	0.033	13.0	12.0	18.0	15.0	3,300	8,250,000	109	10	24.1	4.30	45	75RI2330(1)70(2)	R75RI2330(1)70(2)
1250	600	0.039	10.0	16.0	18.0	15.0	3,300	8,250,000	129	10	20.4	4.72	44	75RI2390(1)30(2)	R75RI2390(1)30(2)
1250	600	0.047	11.0	19.0	18.0	15.0	3,300	8,250,000	155	10	16.9	5.42	40	75RI2470(1)30(2)	R75RI2470(1)30(2)
1250	600	0.056	11.0	19.0	18.0	15.0	3,300	8,250,000	185	10	19.9	5.00	40	75RI2560(1)30(2)	R75RI2560(1)30(2)
1250	600	0.022	6.0	15.0	26.5	22.5	2,100	5,250,000	46	16	36.2	3.57	43	75RN2220(1)30(2)	R75RN2220(1)30(2)
1250	600	0.027	6.0	15.0	26.5	22.5	2,100	5,250,000	57	16	29.5	3.95	43	75RN2270(1)30(2)	R75RN2270(1)30(2)
1250	600	0.033	6.0	15.0	26.5	22.5	2,100	5,250,000	69	16	24.1	4.37	43	75RN2330(1)30(2)	R75RN2330(1)30(2)
1250	600	0.039	6.0	15.0	26.5	22.5	2,100	5,250,000	82	16	20.4	4.75	43	75RN2390(1)30(2)	R75RN2390(1)30(2)
1250	600	0.047	7.0	16.0	26.5	22.5	2,100	5,250,000	99	16	16.9	5.37	41	75RN2470(1)30(2)	R75RN2470(1)30(2)
1250	600	0.056	7.0	16.0	26.5	22.5	2,100	5,250,000	118	16	19.9	4.95	41	75RN2560(1)30(2)	R75RN2560(1)30(2)
1250	600	0.068	8.5	17.0	26.5	22.5	2,100	5,250,000	143	16	16.4	5.64	38	75RN2680(1)30(2)	R75RN2680(1)30(2)
VDC	VAC	Cap Value	T	H	L	Lead Spacing (S)	dV/dt (V/µs)	Max K <sub>0</sub> (V <sup>2</sup> /µs)	A <sub>pk</sub>	nH	mΩ	A <sub>rms</sub>	R <sub>th</sub>	KEMET Internal Part Number	Customer Part Number
									I <sub>pk</sub>	Lead Length 2x 4 mm	at 100 kHz	at 100 kHz, 85°C			
			Dimensions						ESL	ESR max	I <sub>rms</sub> max (*)	(°C/W)			

(1) Insert lead and packaging code. See Ordering Options Table for available options.  
(2) J = 5%, K = 10%, M = 20%  
(3) K = 10%, M = 20%  
(4) H = 2.5%, J = 5%, K = 10%  
(\*) I<sub>rms</sub> value that leads to a ΔT of ≈ 20°C on the box surface > T<sub>BOX</sub> = T<sub>AMB</sub> + ΔT = 85°C + 20°C = 105°C

**Table 1 – Ratings & Part Number Reference cont.**

VDC	VAC	Cap Value (µF)	Dimensions in mm			Lead Spacing (S)	dV/dt (V/µs)	Max K <sub>0</sub> (V <sup>2</sup> /µs)	I <sub>pk</sub>	ESL	ESR max	I <sub>rms</sub> max (*)	R <sub>th</sub>	KEMET Internal Part Number	Customer Part Number
										Lead Length 2x 4 mm	at 100 kHz	at 100 kHz, 85°C			
			A <sub>pk</sub>	nH	mΩ					A <sub>rms</sub>	(°C/W)				
1250	600	0.082	10.0	18.5	26.5	22.5	2,100	5,250,000	172	16	13.6	6.41	36	75RN2820(1)30(2)	R75RN2820(1)30(2)
1250	600	0.1	10.0	18.5	26.5	22.5	2,100	5,250,000	210	16	11.1	7.08	36	75RN3100(1)30(2)	R75RN3100(1)30(2)
1250	600	0.12	11.0	20.0	26.5	22.5	2,100	5,250,000	252	16	9.3	7.97	34	75RN3120(1)30(2)	R75RN3120(1)30(2)
1250	600	0.15	13.0	22.0	26.5	22.5	2,100	5,250,000	315	16	7.4	9.26	31	75RN3150(1)30(2)	R75RN3150(1)30(2)
1250	600	0.18	13.0	22.0	26.5	22.5	2,100	5,250,000	378	16	6.2	10.15	31	75RN3180(1)30(2)	R75RN3180(1)30(2)
1250	600	0.22	14.5	29.5	26.5	22.5	2,100	5,250,000	462	16	5.1	12.04	27	75RN3220(1)30(2)	R75RN3220(1)30(2)
1250	600	0.068	9.0	17.0	32.0	27.5	750	1,875,000	51	18	16.4	5.91	35	75RR2680(1)40(2)	R75RR2680(1)40(2)
1250	600	0.082	9.0	17.0	32.0	27.5	750	1,875,000	62	18	13.6	6.49	35	75RR2820(1)40(2)	R75RR2820(1)40(2)
1250	600	0.1	9.0	17.0	32.0	27.5	750	1,875,000	75	18	11.1	7.17	35	75RR3100(1)40(2)	R75RR3100(1)40(2)
1250	600	0.12	9.0	17.0	32.0	27.5	750	1,875,000	90	18	9.3	7.85	35	75RR3120(1)40(2)	R75RR3120(1)40(2)
1250	600	0.15	11.0	20.0	32.0	27.5	750	1,875,000	113	18	7.4	9.26	31	75RR3150(1)40(2)	R75RR3150(1)40(2)
1250	600	0.18	11.0	20.0	32.0	27.5	750	1,875,000	135	18	6.2	10.14	31	75RR3180(1)40(2)	R75RR3180(1)40(2)
1250	600	0.18	24.0	15.0	32.0	27.5	750	1,875,000	135	18	6.2	10.91	27	75RR3180(1)L4(2)	R75RR3180(1)L4(2)
1250	600	0.22	13.0	22.0	32.0	27.5	750	1,875,000	165	18	5.1	11.65	29	75RR3220(1)40(2)	R75RR3220(1)40(2)
1250	600	0.22	24.0	15.0	32.0	27.5	750	1,875,000	165	18	5.1	12.06	27	75RR3220(1)L4(2)	R75RR3220(1)L4(2)
1250	600	0.27	13.0	25.0	32.0	27.5	750	1,875,000	203	18	10.0	8.48	28	75RR3270(1)40(2)	R75RR3270(1)40(2)
1250	600	0.33	14.0	28.0	32.0	27.5	750	1,875,000	248	18	8.2	9.67	26	75RR3300(1)30(2)	R75RR3300(1)30(2)
1250	600	0.39	18.0	33.0	32.0	27.5	750	1,875,000	293	18	8.2	10.33	23	75RR3390(1)40(2)	R75RR3390(1)40(2)
1250	600	0.47	18.0	33.0	32.0	27.5	750	1,875,000	353	18	6.8	11.35	23	75RR3470(1)40(2)	R75RR3470(1)40(2)
1250	600	0.56	18.0	33.0	32.0	27.5	750	1,875,000	420	18	5.7	12.38	23	75RR3560(1)40(2)	R75RR3560(1)40(2)
1250	600	0.68	22.0	37.0	32.0	27.5	750	1,875,000	510	18	4.7	14.35	21	75RR3680(1)40(2)	R75RR3680(1)40(2)
1250	600	0.82	22.0	37.0	32.0	27.5	750	1,875,000	615	18	3.9	15.75	21	75RR3820(1)40(2)	R75RR3820(1)40(2)
1250	600	0.15	11.0	22.0	41.5	37.5	550	1,375,000	83	20	7.4	9.97	27	75RW3150(1)30(2)	R75RW3150(1)30(2)
1250	600	0.22	11.0	22.0	41.5	37.5	550	1,375,000	121	20	5.1	12.07	27	75RW3220(1)30(2)	R75RW3220(1)30(2)
1250	600	0.27	11.0	22.0	41.5	37.5	550	1,375,000	149	20	10.0	8.58	27	75RW3270(1)30(2)	R75RW3270(1)30(2)
1250	600	0.27	24.0	15.0	41.5	37.5	550	1,375,000	149	20	10.0	9.05	24	75RW3270(1)L3(2)	R75RW3270(1)L3(2)
1250	600	0.33	13.0	24.0	41.5	37.5	550	1,375,000	182	20	8.2	9.83	25	75RW3330(1)20(2)	R75RW3330(1)20(2)
1250	600	0.39	13.0	24.0	41.5	37.5	550	1,375,000	215	20	8.2	9.85	25	75RW3390(1)30(2)	R75RW3390(1)30(2)
1250	600	0.39	24.0	15.0	41.5	37.5	550	1,375,000	215	20	8.2	10.02	24	75RW3390(1)L3(2)	R75RW3390(1)L3(2)
1250	600	0.47	16.0	28.5	41.5	37.5	550	1,375,000	259	20	6.8	11.44	23	75RW3470(1)40(2)	R75RW3470(1)40(2)
1250	600	0.47	24.0	19.0	41.5	37.5	550	1,375,000	259	20	6.8	11.36	23	75RW3470(1)L4(2)	R75RW3470(1)L4(2)
1250	600	0.56	16.0	28.5	41.5	37.5	550	1,375,000	308	20	5.7	12.49	23	75RW3560(1)40(2)	R75RW3560(1)40(2)
1250	600	0.68	19.0	32.0	41.5	37.5	550	1,375,000	374	20	4.7	14.38	21	75RW3680(1)30(2)	R75RW3680(1)30(2)
1250	600	0.82	19.0	32.0	41.5	37.5	550	1,375,000	451	20	3.9	15.79	21	75RW3820(1)40(2)	R75RW3820(1)40(2)
1250	600	1	20.0	40.0	41.5	37.5	550	1,375,000	550	20	3.2	18.30	19	75RW4100(1)30(2)	R75RW4100(1)30(2)
1250	600	1.2	20.0	40.0	41.5	37.5	550	1,375,000	660	20	4.0	16.37	19	75RW4120(1)40(2)	R75RW4120(1)40(2)
1250	600	1.5	24.0	44.0	41.5	37.5	550	1,375,000	825	20	3.2	19.10	17	75RW4150(1)40(2)	R75RW4150(1)40(2)
1250	600	1.8	30.0	45.0	41.5	37.5	550	1,375,000	990	20	2.7	21.69	16	75RW4180(1)20(2)	R75RW4180(1)20(2)
1300	400	0.0068	5.0	11.0	18.0	15.0	2,000	5,200,000	14	10	117.0	1.68	60	75J1680(1)00(2)	R75J1680(1)00(2)
1300	400	0.0082	5.0	11.0	18.0	15.0	2,000	5,200,000	16	10	97.0	1.85	60	75J1820(1)00(2)	R75J1820(1)00(2)
1300	400	0.01	5.0	11.0	18.0	15.0	2,000	5,200,000	20	10	79.6	2.04	60	75J2100(1)00(2)	R75J2100(1)00(2)
1300	400	0.012	6.0	12.0	18.0	15.0	2,000	5,200,000	24	10	92.8	1.96	56	75J2120(1)00(2)	R75J2120(1)00(2)
1300	400	0.015	6.0	12.0	18.0	15.0	2,000	5,200,000	30	10	74.3	2.19	56	75J2150(1)00(2)	R75J2150(1)00(2)
1300	400	0.018	7.5	13.5	18.0	15.0	2,000	5,200,000	36	10	61.9	2.53	51	75J2180(1)00(2)	R75J2180(1)00(2)
1300	400	0.022	7.5	13.5	18.0	15.0	2,000	5,200,000	44	10	50.6	2.79	51	75J2220(1)00(2)	R75J2220(1)00(2)
1300	400	0.027	8.5	14.5	18.0	15.0	2,000	5,200,000	54	10	41.3	3.19	48	75J2270(1)00(2)	R75J2270(1)00(2)
1300	400	0.033	8.5	14.5	18.0	15.0	2,000	5,200,000	66	10	33.8	3.52	48	75J2330(1)00(2)	R75J2330(1)00(2)
1300	400	0.039	10.0	16.0	18.0	15.0	2,000	5,200,000	78	10	28.6	3.99	44	75J2390(1)00(2)	R75J2390(1)00(2)
1300	400	0.047	10.0	16.0	18.0	15.0	2,000	5,200,000	94	10	23.7	4.38	44	75J2470(1)00(2)	R75J2470(1)00(2)
1300	400	0.056	11.0	19.0	18.0	15.0	2,000	5,200,000	112	10	28.4	4.18	40	75J2560(1)00(2)	R75J2560(1)00(2)
VDC	VAC	Cap Value	T	H	L	Lead Spacing (S)	dV/dt (V/µs)	Max K <sub>0</sub> (V <sup>2</sup> /µs)	A <sub>pk</sub>	ESL	ESR max	A <sub>rms</sub>	R <sub>th</sub>	KEMET Internal Part Number	Customer Part Number
									I <sub>pk</sub>	Lead Length 2x 4 mm	at 100 kHz	at 100 kHz, 85°C			
			Dimensions						I <sub>pk</sub>	ESL	ESR max	I <sub>rms</sub> max (*)	R <sub>th</sub>		

(1) Insert lead and packaging code. See Ordering Options Table for available options.  
(2) J = 5%, K = 10%, M = 20%  
(3) K = 10%, M = 20%  
(4) H = 2.5%, J = 5%, K = 10%  
(\*) I<sub>rms</sub> value that leads to a ΔT of ≈ 20°C on the box surface > T<sub>BOX</sub> = T<sub>AMB</sub> + ΔT = 85°C + 20°C = 105°C

**Table 1 – Ratings & Part Number Reference cont.**

VDC	VAC	Cap Value (µF)	Dimensions in mm			Lead Spacing (S)	dV/dt (V/µs)	Max K <sub>v</sub> (V <sup>2</sup> /µs)	I <sub>pk</sub>	ESL	ESR max	I <sub>rms</sub> max (*)	R <sub>th</sub>	KEMET Internal Part Number	Customer Part Number
										Lead Length 2x 4 mm	at 100 kHz	at 100 kHz, 85°C			
			T	H	L				A <sub>pk</sub>	nH	mΩ	A <sub>rms</sub>	(°C/W)		
1300	400	0.039	6.0	15.0	26.5	22.5	800	2,080,000	31	16	61.2	2.74	43	75JN2390(1)00(2)	R75JN2390(1)00(2)
1300	400	0.047	6.0	15.0	26.5	22.5	800	2,080,000	38	16	50.8	3.01	43	75JN2470(1)00(2)	R75JN2470(1)00(2)
1300	400	0.056	6.0	15.0	26.5	22.5	800	2,080,000	45	16	48.3	3.09	43	75JN2560(1)00(2)	R75JN2560(1)00(2)
1300	400	0.068	7.0	16.0	26.5	22.5	800	2,080,000	54	16	39.8	3.50	41	75JN2680(1)00(2)	R75JN2680(1)00(2)
1300	400	0.082	8.5	17.0	26.5	22.5	800	2,080,000	66	16	33.0	3.97	38	75JN2820(1)00(2)	R75JN2820(1)00(2)
1300	400	0.1	8.5	17.0	26.5	22.5	800	2,080,000	80	16	27.1	4.39	38	75JN3100(1)00(2)	R75JN3100(1)00(2)
1300	400	0.12	10.0	18.5	26.5	22.5	800	2,080,000	96	16	22.5	4.98	36	75JN3120(1)00(2)	R75JN3120(1)00(2)
1300	400	0.15	11.0	20.0	26.5	22.5	800	2,080,000	120	16	18.0	5.71	34	75JN3150(1)00(2)	R75JN3150(1)00(2)
1300	400	0.18	11.0	20.0	26.5	22.5	800	2,080,000	144	16	15.0	6.26	34	75JN3180(1)00(2)	R75JN3180(1)00(2)
1300	400	0.22	13.0	22.0	26.5	22.5	800	2,080,000	176	16	12.3	7.20	31	75JN3220(1)00(2)	R75JN3220(1)00(2)
1300	400	0.15	9.0	17.0	32.0	27.5	380	988,000	57	18	18.0	5.63	35	75JR3150(1)00(2)	R75JR3150(1)00(2)
1300	400	0.18	9.0	17.0	32.0	27.5	380	988,000	68	18	15.0	6.17	35	75JR3180(1)00(2)	R75JR3180(1)00(2)
1300	400	0.22	11.0	20.0	32.0	27.5	380	988,000	84	18	12.3	7.20	31	75JR3220(1)00(2)	R75JR3220(1)00(2)
1300	400	0.27	11.0	20.0	32.0	27.5	380	988,000	103	18	11.8	7.35	31	75JR3270(1)00(2)	R75JR3270(1)00(2)
1300	400	0.33	13.0	22.0	32.0	27.5	380	988,000	125	18	9.6	8.44	29	75JR3330(1)00(2)	R75JR3330(1)00(2)
1300	400	0.39	13.0	22.0	32.0	27.5	380	988,000	148	18	10.2	8.21	29	75JR3390(1)00(2)	R75JR3390(1)00(2)
1300	400	0.47	14.0	28.0	32.0	27.5	380	988,000	179	18	8.5	9.52	26	75JR3470(1)00(2)	R75JR3470(1)00(2)
1300	400	0.56	14.0	28.0	32.0	27.5	380	988,000	213	18	11.4	8.21	26	75JR3560(1)00(2)	R75JR3560(1)00(2)
1300	400	0.68	14.0	28.0	32.0	27.5	380	988,000	258	18	9.4	9.05	26	75JR3680(1)00(2)	R75JR3680(1)00(2)
1300	400	0.82	18.0	33.0	32.0	27.5	380	988,000	312	18	9.7	9.48	23	75JR3820(1)00(2)	R75JR3820(1)00(2)
1300	400	1	18.0	33.0	32.0	27.5	380	988,000	380	18	8.0	10.47	23	75JR4100(1)00(2)	R75JR4100(1)00(2)
1300	400	0.39	11.0	22.0	41.5	37.5	180	468,000	70	20	10.2	8.50	27	75JW3390(1)00(2)	R75JW3390(1)00(2)
1300	400	0.47	11.0	22.0	41.5	37.5	180	468,000	85	20	8.5	9.34	27	75JW3470(1)00(2)	R75JW3470(1)00(2)
1300	400	0.56	13.0	24.0	41.5	37.5	180	468,000	101	20	11.4	8.35	25	75JW3560(1)00(2)	R75JW3560(1)00(2)
1300	400	0.68	13.0	24.0	41.5	37.5	180	468,000	122	20	9.4	9.20	25	75JW3680(1)00(2)	R75JW3680(1)00(2)
1300	400	0.82	16.0	28.5	41.5	37.5	180	468,000	148	20	9.7	9.56	23	75JW3820(1)00(2)	R75JW3820(1)00(2)
1300	400	1	16.0	28.5	41.5	37.5	180	468,000	180	20	8.0	10.56	23	75JW4100(1)00(2)	R75JW4100(1)00(2)
1300	400	1.2	19.0	32.0	41.5	37.5	180	468,000	216	20	13.3	8.54	21	75JW4120(1)00(2)	R75JW4120(1)00(2)
1300	400	1.5	20.0	40.0	41.5	37.5	180	468,000	270	20	10.6	10.03	19	75JW4150(1)00(2)	R75JW4150(1)00(2)
1300	400	1.8	20.0	40.0	41.5	37.5	180	468,000	324	20	8.8	10.98	19	75JW4180(1)00(2)	R75JW4180(1)00(2)
1300	400	2.2	24.0	44.0	41.5	37.5	180	468,000	396	20	7.2	12.67	17	75JW4220(1)00(2)	R75JW4220(1)00(2)
1300	400	2.7	24.0	44.0	41.5	37.5	180	468,000	486	20	8.8	11.46	17	75JW4270(1)00(2)	R75JW4270(1)00(2)
1300	400	3.3	30.0	45.0	41.5	37.5	180	468,000	594	20	7.2	13.13	16	75JW4330(1)00(2)	R75JW4330(1)00(2)
1600	650	0.0022	4.0	10.0	18.0	15.0	6,000	19,200,000	13	10	361.7	0.90	65	75TI1220(1)30(2)	R75TI1220(1)30(2)
1600	650	0.0033	4.0	10.0	18.0	15.0	6,000	19,200,000	20	10	241.1	1.13	65	75TI1330(1)30(2)	R75TI1330(1)30(2)
1600	650	0.0039	4.0	10.0	18.0	15.0	6,000	19,200,000	23	10	204.0	1.22	65	75TI1390(1)30(2)	R75TI1390(1)30(2)
1600	650	0.0047	4.0	10.0	18.0	15.0	6,000	19,200,000	28	10	169.3	1.34	65	75TI1470(1)30(2)	R75TI1470(1)30(2)
1600	650	0.0056	5.0	11.0	18.0	15.0	6,000	19,200,000	34	10	142.1	1.53	60	75TI1560(1)30(2)	R75TI1560(1)30(2)
1600	650	0.0068	5.0	11.0	18.0	15.0	6,000	19,200,000	41	10	117.0	1.68	60	75TI1680(1)30(2)	R75TI1680(1)30(2)
1600	650	0.0082	6.0	12.0	18.0	15.0	6,000	19,200,000	49	10	97.0	1.92	56	75TI1820(1)30(2)	R75TI1820(1)30(2)
1600	650	0.01	6.0	12.0	18.0	15.0	6,000	19,200,000	60	10	79.6	2.12	56	75TI2100(1)30(2)	R75TI2100(1)30(2)
1600	650	0.012	7.5	13.5	18.0	15.0	6,000	19,200,000	72	10	66.3	2.44	51	75TI2120(1)30(2)	R75TI2120(1)30(2)
1600	650	0.015	7.5	13.5	18.0	15.0	6,000	19,200,000	90	10	53.1	2.73	51	75TI2150(1)30(2)	R75TI2150(1)30(2)
1600	650	0.018	8.5	14.5	18.0	15.0	6,000	19,200,000	108	10	44.2	3.08	48	75TI2180(1)30(2)	R75TI2180(1)30(2)
1600	650	0.018	9.0	12.5	18.0	15.0	6,000	19,200,000	108	10	44.2	3.02	50	75TI2180(1)70(2)	R75TI2180(1)70(2)
1600	650	0.022	10.0	16.0	18.0	15.0	6,000	19,200,000	132	10	36.2	3.54	44	75TI2220(1)30(2)	R75TI2220(1)30(2)
1600	650	0.022	13.0	12.0	18.0	15.0	6,000	19,200,000	132	10	36.2	3.51	45	75TI2220(1)70(2)	R75TI2220(1)70(2)
1600	650	0.027	10.0	16.0	18.0	15.0	6,000	19,200,000	162	10	29.5	3.92	44	75TI2270(1)30(2)	R75TI2270(1)30(2)
1600	650	0.033	11.0	19.0	18.0	15.0	6,000	19,200,000	198	10	24.1	4.54	40	75TI2330(1)30(2)	R75TI2330(1)30(2)
1600	650	0.0068	6.0	15.0	26.5	22.5	3,000	9,600,000	20	16	117.0	1.98	43	75TN1680(1)30(2)	R75TN1680(1)30(2)
VDC	VAC	Cap Value	T	H	L	Lead Spacing (S)	dV/dt (V/µs)	Max K <sub>v</sub> (V <sup>2</sup> /µs)	A <sub>pk</sub>	ESL	ESR max	A <sub>rms</sub>	R <sub>th</sub>	KEMET Internal Part Number	Customer Part Number
									I <sub>pk</sub>	Lead Length 2x 4 mm	at 100 kHz	at 100 kHz, 85°C			
			Dimensions						ESL	ESR max	I <sub>rms</sub> max (*)	(°C/W)			

(1) Insert lead and packaging code. See Ordering Options Table for available options.  
(2) J = 5%, K = 10%, M = 20%  
(3) K = 10%, M = 20%  
(4) H = 2.5%, J = 5%, K = 10%  
(\*) I<sub>rms</sub> value that leads to a ΔT of ≈ 20°C on the box surface > T<sub>BOX</sub> = T<sub>AMB</sub> + ΔT = 85°C + 20°C = 105°C

**Table 1 – Ratings & Part Number Reference cont.**

VDC	VAC	Cap Value (µF)	Dimensions in mm			Lead Spacing (S)	dV/dt (V/µs)	Max K <sub>v</sub> (V <sup>2</sup> /µs)	I <sub>pk</sub>	ESL	ESR max	I <sub>rms</sub> max (*)		R <sub>th</sub>	KEMET Internal Part Number	Customer Part Number
										Lead Length 2x 4 mm	at 100 kHz	at 100 kHz, 85°C	A <sub>rms</sub>			
			T	H	L				A <sub>pk</sub>	nH	mΩ	(°C/W)				
1600	650	0.01	6.0	15.0	26.5	22.5	3,000	9,600,000	30	16	79.6	2.41	43	75TN2100(1)30(2)	R75TN2100(1)30(2)	
1600	650	0.015	6.0	15.0	26.5	22.5	3,000	9,600,000	45	16	53.1	2.95	43	75TN2150(1)30(2)	R75TN2150(1)30(2)	
1600	650	0.018	6.0	15.0	26.5	22.5	3,000	9,600,000	54	16	44.2	3.23	43	75TN2180(1)30(2)	R75TN2180(1)30(2)	
1600	650	0.022	6.0	15.0	26.5	22.5	3,000	9,600,000	66	16	36.2	3.57	43	75TN2220(1)30(2)	R75TN2220(1)30(2)	
1600	650	0.027	6.0	15.0	26.5	22.5	3,000	9,600,000	81	16	29.5	3.95	43	75TN2270(1)30(2)	R75TN2270(1)30(2)	
1600	650	0.033	7.0	16.0	26.5	22.5	3,000	9,600,000	99	16	24.1	4.50	41	75TN2330(1)30(2)	R75TN2330(1)30(2)	
1600	650	0.039	7.0	16.0	26.5	22.5	3,000	9,600,000	117	16	20.4	4.89	41	75TN2390(1)30(2)	R75TN2390(1)30(2)	
1600	650	0.047	8.5	17.0	26.5	22.5	3,000	9,600,000	141	16	16.9	5.55	38	75TN2470(1)30(2)	R75TN2470(1)30(2)	
1600	650	0.056	10.0	18.5	26.5	22.5	3,000	9,600,000	168	16	19.9	5.30	36	75TN2560(1)30(2)	R75TN2560(1)30(2)	
1600	650	0.068	10.0	18.5	26.5	22.5	3,000	9,600,000	204	16	16.4	5.84	36	75TN2680(1)30(2)	R75TN2680(1)30(2)	
1600	650	0.082	11.0	20.0	26.5	22.5	3,000	9,600,000	246	16	13.6	6.58	34	75TN2820(1)30(2)	R75TN2820(1)30(2)	
1600	650	0.1	13.0	22.0	26.5	22.5	3,000	9,600,000	300	16	11.1	7.56	31	75TN3100(1)30(2)	R75TN3100(1)30(2)	
1600	650	0.12	13.0	22.0	26.5	22.5	3,000	9,600,000	360	16	9.3	8.29	31	75TN3120(1)30(2)	R75TN3120(1)30(2)	
1600	650	0.047	9.0	17.0	32.0	27.5	1,500	4,800,000	71	18	16.9	5.81	35	75TR2470(1)30(2)	R75TR2470(1)30(2)	
1600	650	0.056	9.0	17.0	32.0	27.5	1,500	4,800,000	84	18	19.9	5.36	35	75TR2560(1)30(2)	R75TR2560(1)30(2)	
1600	650	0.068	9.0	17.0	32.0	27.5	1,500	4,800,000	102	18	16.4	5.91	35	75TR2680(1)30(2)	R75TR2680(1)30(2)	
1600	650	0.082	9.0	17.0	32.0	27.5	1,500	4,800,000	123	18	13.6	6.49	35	75TR2820(1)30(2)	R75TR2820(1)30(2)	
1600	650	0.1	11.0	20.0	32.0	27.5	1,500	4,800,000	150	18	11.1	7.56	31	75TR3100(1)40(2)	R75TR3100(1)40(2)	
1600	650	0.12	11.0	20.0	32.0	27.5	1,500	4,800,000	180	18	9.3	8.28	31	75TR3120(1)30(2)	R75TR3120(1)30(2)	
1600	650	0.12	24.0	15.0	32.0	27.5	1,500	4,800,000	180	18	9.3	8.91	27	75TR3120(1)L3(2)	R75TR3120(1)L3(2)	
1600	650	0.15	13.0	22.0	32.0	27.5	1,500	4,800,000	225	18	7.4	9.62	29	75TR3150(1)30(2)	R75TR3150(1)30(2)	
1600	650	0.15	24.0	15.0	32.0	27.5	1,500	4,800,000	225	18	7.4	9.96	27	75TR3150(1)L3(2)	R75TR3150(1)L3(2)	
1600	650	0.18	13.0	25.0	32.0	27.5	1,500	4,800,000	270	18	6.2	10.79	28	75TR3180(1)20(2)	R75TR3180(1)20(2)	
1600	650	0.22	13.0	25.0	32.0	27.5	1,500	4,800,000	330	18	5.1	11.93	28	75TR3220(1)40(3)	R75TR3220(1)40(3)	
1600	650	0.22	14.0	28.0	32.0	27.5	1,500	4,800,000	330	18	5.1	12.30	26	75TR3220(1)30(2)	R75TR3220(1)30(2)	
1600	650	0.27	14.0	28.0	32.0	27.5	1,500	4,800,000	405	18	10.0	8.75	26	75TR3270(1)40(2)	R75TR3270(1)40(2)	
1600	650	0.27	18.0	33.0	32.0	27.5	1,500	4,800,000	405	18	10.0	9.33	23	75TR3270(1)30(2)	R75TR3270(1)30(2)	
1600	650	0.33	18.0	33.0	32.0	27.5	1,500	4,800,000	495	18	8.2	10.31	23	75TR3330(1)30(2)	R75TR3330(1)30(2)	
1600	650	0.39	18.0	33.0	32.0	27.5	1,500	4,800,000	585	18	8.2	10.33	23	75TR3390(1)30(2)	R75TR3390(1)30(2)	
1600	650	0.47	22.0	37.0	32.0	27.5	1,500	4,800,000	705	18	6.8	11.93	21	75TR3470(1)30(2)	R75TR3470(1)30(2)	
1600	650	0.56	22.0	37.0	32.0	27.5	1,500	4,800,000	840	18	5.7	13.02	21	75TR3560(1)30(2)	R75TR3560(1)30(2)	
1600	650	0.1	11.0	22.0	41.5	37.5	750	2,400,000	75	20	11.1	8.14	27	75TW3100(1)30(2)	R75TW3100(1)30(2)	
1600	650	0.15	11.0	22.0	41.5	37.5	750	2,400,000	113	20	7.4	9.97	27	75TW3150(1)30(2)	R75TW3150(1)30(2)	
1600	650	0.15	24.0	15.0	41.5	37.5	750	2,400,000	113	20	7.4	10.51	24	75TW3150(1)L3(2)	R75TW3150(1)L3(2)	
1600	650	0.18	11.0	22.0	41.5	37.5	750	2,400,000	135	20	6.2	8.34	27	75TW3180(1)30(2)	R75TW3180(1)30(2)	
1600	650	0.22	13.0	24.0	41.5	37.5	750	2,400,000	165	20	5.1	9.55	25	75TW3220(1)20(2)	R75TW3220(1)20(2)	
1600	650	0.22	24.0	15.0	41.5	37.5	750	2,400,000	165	20	5.1	9.72	24	75TW3220(1)L2(2)	R75TW3220(1)L2(2)	
1600	650	0.27	13.0	24.0	41.5	37.5	750	2,400,000	203	20	10.0	8.89	25	75TW3270(1)30(2)	R75TW3270(1)30(2)	
1600	650	0.27	24.0	15.0	41.5	37.5	750	2,400,000	203	20	10.0	9.05	24	75TW3270(1)L3(2)	R75TW3270(1)L3(2)	
1600	650	0.33	16.0	28.5	41.5	37.5	750	2,400,000	248	20	8.2	10.40	23	75TW3330(1)30(2)	R75TW3330(1)30(2)	
1600	650	0.33	24.0	19.0	41.5	37.5	750	2,400,000	248	20	8.2	10.33	23	75TW3330(1)L3(2)	R75TW3330(1)L3(2)	
1600	650	0.39	16.0	28.5	41.5	37.5	750	2,400,000	293	20	8.2	10.43	23	75TW3390(1)30(2)	R75TW3390(1)30(2)	
1600	650	0.47	19.0	32.0	41.5	37.5	750	2,400,000	353	20	6.8	11.95	21	75TW3470(1)20(2)	R75TW3470(1)20(2)	
1600	650	0.56	19.0	32.0	41.5	37.5	750	2,400,000	420	20	5.7	13.05	21	75TW3560(1)30(2)	R75TW3560(1)30(2)	
1600	650	0.68	20.0	40.0	41.5	37.5	750	2,400,000	510	20	4.7	15.09	19	75TW3680(1)20(2)	R75TW3680(1)20(2)	
1600	650	0.82	20.0	40.0	41.5	37.5	750	2,400,000	615	20	3.9	16.57	19	75TW3820(1)30(2)	R75TW3820(1)30(2)	
1600	650	1	24.0	44.0	41.5	37.5	750	2,400,000	750	20	3.2	19.10	17	75TW4100(1)30(2)	R75TW4100(1)30(2)	
1600	650	1.2	24.0	44.0	41.5	37.5	750	2,400,000	900	20	4.0	17.08	17	75TW4120(1)30(2)	R75TW4120(1)30(2)	
1600	650	1.5	30.0	45.0	41.5	37.5	750	2,400,000	1,125	20	3.2	19.80	16	75TW4150(1)30(2)	R75TW4150(1)30(2)	
2000	700	0.001	4.0	10.0	18.0	15.0	9,500	38,000,000	10	10	795.8	0.44	65	75UI1100(1)40(2)	R75UI1100(1)40(2)	

VDC	VAC	Cap Value	T	H	L	Lead Spacing (S)	dV/dt (V/µs)	Max K <sub>v</sub> (V <sup>2</sup> /µs)	A <sub>pk</sub>	ESL	ESR max	A <sub>rms</sub>	R <sub>th</sub>	KEMET Internal Part Number	Customer Part Number
										Lead Length 2x 4 mm	at 100 kHz	at 100 kHz, 85°C			
			Dimensions						I <sub>pk</sub>	ESL	ESR max	I <sub>rms</sub> max (*)			

(1) Insert lead and packaging code. See Ordering Options Table for available options.  
(2) J = 5%, K = 10%, M = 20%  
(3) K = 10%, M = 20%  
(4) H = 2.5%, J = 5%, K = 10%  
(\*) I<sub>rms</sub> value that leads to a ΔT of ≈ 20°C on the box surface > T<sub>BOX</sub> = T<sub>AMB</sub> + ΔT = 85°C + 20°C = 105°C

**Table 1 – Ratings & Part Number Reference cont.**

VDC	VAC	Cap Value (µF)	Dimensions in mm			Lead Spacing (S)	dV/dt (V/µs)	Max K <sub>0</sub> (V <sup>2</sup> /µs)	I <sub>pk</sub>	ESL	ESR max	I <sub>rms</sub> max (*)	R <sub>th</sub>	KEMET Internal Part Number	Customer Part Number
										Lead Length 2x 4 mm	at 100 kHz	at 100 kHz, 85°C			
			T	H	L				A <sub>pk</sub>	nH	mΩ	A <sub>rms</sub>	(°C/W)		
2000	700	0.0012	4.0	10.0	18.0	15.0	9,500	38,000,000	11	10	663.1	0.53	65	75U1120(1)40(2)	R75U1120(1)40(2)
2000	700	0.0015	4.0	10.0	18.0	15.0	9,500	38,000,000	14	10	530.5	0.66	65	75U1150(1)40(2)	R75U1150(1)40(2)
2000	700	0.0018	4.0	10.0	18.0	15.0	9,500	38,000,000	17	10	442.1	0.79	65	75U1180(1)40(2)	R75U1180(1)40(2)
2000	700	0.0022	4.0	10.0	18.0	15.0	9,500	38,000,000	21	10	361.7	0.92	65	75U1220(1)40(2)	R75U1220(1)40(2)
2000	700	0.0027	4.0	10.0	18.0	15.0	9,500	38,000,000	26	10	294.7	1.02	65	75U1270(1)40(2)	R75U1270(1)40(2)
2000	700	0.0033	4.0	10.0	18.0	15.0	9,500	38,000,000	31	10	241.1	1.13	65	75U1330(1)40(2)	R75U1330(1)40(2)
2000	700	0.0039	5.0	11.0	18.0	15.0	9,500	38,000,000	37	10	204.0	1.28	60	75U1390(1)30(2)	R75U1390(1)30(2)
2000	700	0.0047	5.0	11.0	18.0	15.0	9,500	38,000,000	45	10	169.3	1.40	60	75U1470(1)30(2)	R75U1470(1)30(2)
2000	700	0.0056	6.0	12.0	18.0	15.0	9,500	38,000,000	53	10	142.1	1.59	56	75U1560(1)30(2)	R75U1560(1)30(2)
2000	700	0.0068	6.0	12.0	18.0	15.0	9,500	38,000,000	65	10	117.0	1.75	56	75U1680(1)30(2)	R75U1680(1)30(2)
2000	700	0.0082	7.5	13.5	18.0	15.0	9,500	38,000,000	78	10	97.0	2.02	51	75U1820(1)30(2)	R75U1820(1)30(2)
2000	700	0.01	7.5	13.5	18.0	15.0	9,500	38,000,000	95	10	79.6	2.23	51	75U2100(1)30(2)	R75U2100(1)30(2)
2000	700	0.012	8.5	14.5	18.0	15.0	9,500	38,000,000	114	10	66.3	2.51	48	75U2120(1)30(2)	R75U2120(1)30(2)
2000	700	0.012	9.0	12.5	18.0	15.0	9,500	38,000,000	114	10	66.3	2.47	50	75U2120(1)70(2)	R75U2120(1)70(2)
2000	700	0.015	8.5	14.5	18.0	15.0	9,500	38,000,000	143	10	53.1	2.81	48	75U2150(1)30(2)	R75U2150(1)30(2)
2000	700	0.015	13.0	12.0	18.0	15.0	9,500	38,000,000	143	10	53.1	2.90	45	75U2150(1)70(2)	R75U2150(1)70(2)
2000	700	0.018	10.0	16.0	18.0	15.0	9,500	38,000,000	171	10	44.2	3.20	44	75U2180(1)30(2)	R75U2180(1)30(2)
2000	700	0.018	13.0	12.0	18.0	15.0	9,500	38,000,000	171	10	44.2	3.17	45	75U2180(1)70(2)	R75U2180(1)70(2)
2000	700	0.022	11.0	19.0	18.0	15.0	9,500	38,000,000	209	10	36.2	3.71	40	75U2220(1)30(2)	R75U2220(1)30(2)
2000	700	0.027	11.0	19.0	18.0	15.0	9,500	38,000,000	257	10	29.5	4.11	40	75U2270(1)30(2)	R75U2270(1)30(2)
2000	700	0.0033	6.0	15.0	26.5	22.5	4,000	16,000,000	13	16	241.1	1.38	43	75UN1330(1)30(2)	R75UN1330(1)30(2)
2000	700	0.0047	6.0	15.0	26.5	22.5	4,000	16,000,000	19	16	169.3	1.65	43	75UN1470(1)30(2)	R75UN1470(1)30(2)
2000	700	0.0056	6.0	15.0	26.5	22.5	4,000	16,000,000	22	16	142.1	1.80	43	75UN1560(1)30(2)	R75UN1560(1)30(2)
2000	700	0.0068	6.0	15.0	26.5	22.5	4,000	16,000,000	27	16	117.0	1.98	43	75UN1680(1)30(2)	R75UN1680(1)30(2)
2000	700	0.0082	6.0	15.0	26.5	22.5	4,000	16,000,000	33	16	97.0	2.18	43	75UN1820(1)30(2)	R75UN1820(1)30(2)
2000	700	0.01	6.0	15.0	26.5	22.5	4,000	16,000,000	40	16	79.6	2.41	43	75UN2100(1)30(2)	R75UN2100(1)30(2)
2000	700	0.012	6.0	15.0	26.5	22.5	4,000	16,000,000	48	16	66.3	2.64	43	75UN2120(1)30(2)	R75UN2120(1)30(2)
2000	700	0.015	6.0	15.0	26.5	22.5	4,000	16,000,000	60	16	53.1	2.95	43	75UN2150(1)30(2)	R75UN2150(1)30(2)
2000	700	0.018	6.0	15.0	26.5	22.5	4,000	16,000,000	72	16	44.2	3.23	43	75UN2180(1)30(2)	R75UN2180(1)30(2)
2000	700	0.022	6.0	15.0	26.5	22.5	4,000	16,000,000	88	16	36.2	3.57	43	75UN2220(1)30(2)	R75UN2220(1)30(2)
2000	700	0.027	7.0	16.0	26.5	22.5	4,000	16,000,000	108	16	29.5	4.07	41	75UN2270(1)30(2)	R75UN2270(1)30(2)
2000	700	0.033	8.5	17.0	26.5	22.5	4,000	16,000,000	132	16	24.1	4.65	38	75UN2330(1)30(2)	R75UN2330(1)30(2)
2000	700	0.039	10.0	18.5	26.5	22.5	4,000	16,000,000	156	16	20.4	5.23	36	75UN2390(1)30(2)	R75UN2390(1)30(2)
2000	700	0.047	10.0	18.5	26.5	22.5	4,000	16,000,000	188	16	16.9	5.74	36	75UN2470(1)30(2)	R75UN2470(1)30(2)
2000	700	0.056	11.0	20.0	26.5	22.5	4,000	16,000,000	224	16	19.9	5.44	34	75UN2560(1)30(2)	R75UN2560(1)30(2)
2000	700	0.068	13.0	22.0	26.5	22.5	4,000	16,000,000	272	16	16.4	6.24	31	75UN2680(1)30(2)	R75UN2680(1)30(2)
2000	700	0.022	9.0	17.0	32.0	27.5	2,000	8,000,000	44	18	36.2	3.98	35	75UR2220(1)30(2)	R75UR2220(1)30(2)
2000	700	0.027	9.0	17.0	32.0	27.5	2,000	8,000,000	54	18	29.5	4.41	35	75UR2270(1)30(2)	R75UR2270(1)30(2)
2000	700	0.033	9.0	17.0	32.0	27.5	2,000	8,000,000	66	18	24.1	4.87	35	75UR2330(1)30(2)	R75UR2330(1)30(2)
2000	700	0.039	9.0	17.0	32.0	27.5	2,000	8,000,000	78	18	20.4	5.30	35	75UR2390(1)30(2)	R75UR2390(1)30(2)
2000	700	0.047	9.0	17.0	32.0	27.5	2,000	8,000,000	94	18	16.9	5.81	35	75UR2470(1)30(2)	R75UR2470(1)30(2)
2000	700	0.056	9.0	17.0	32.0	27.5	2,000	8,000,000	112	18	19.9	5.36	35	75UR2560(1)30(2)	R75UR2560(1)30(2)
2000	700	0.068	9.0	17.0	32.0	27.5	2,000	8,000,000	136	18	16.4	5.91	35	75UR2680(1)40(2)	R75UR2680(1)40(2)
2000	700	0.082	11.0	20.0	32.0	27.5	2,000	8,000,000	164	18	13.6	6.85	31	75UR2820(1)40(2)	R75UR2820(1)40(2)
2000	700	0.1	11.0	20.0	32.0	27.5	2,000	8,000,000	200	18	11.1	7.56	31	75UR3100(1)30(2)	R75UR3100(1)30(2)
2000	700	0.1	24.0	15.0	32.0	27.5	2,000	8,000,000	200	18	11.1	8.13	27	75UR3100(1)L3(2)	R75UR3100(1)L3(2)
2000	700	0.12	13.0	22.0	32.0	27.5	2,000	8,000,000	240	18	9.3	8.61	29	75UR3120(1)30(2)	R75UR3120(1)30(2)
2000	700	0.15	13.0	25.0	32.0	27.5	2,000	8,000,000	300	18	7.4	9.85	28	75UR3150(1)40(2)	R75UR3150(1)40(2)
2000	700	0.15	24.0	15.0	32.0	27.5	2,000	8,000,000	300	18	7.4	9.96	27	75UR3150(1)L4(2)	R75UR3150(1)L4(2)
2000	700	0.18	13.0	25.0	32.0	27.5	2,000	8,000,000	360	18	6.2	10.79	28	75UR3180(1)40(2)	R75UR3180(1)40(2)
VDC	VAC	Cap Value	T	H	L	Lead Spacing (S)	dV/dt (V/µs)	Max K <sub>0</sub> (V <sup>2</sup> /µs)	A <sub>pk</sub>	nH	mΩ	A <sub>rms</sub>	R <sub>th</sub>	KEMET Internal Part Number	Customer Part Number
									I <sub>pk</sub>	Lead Length 2x 4 mm	at 100 kHz	at 100 kHz, 85°C			
			Dimensions						I <sub>pk</sub>	ESL	ESR max	I <sub>rms</sub> max (*)	R <sub>th</sub>		

(1) Insert lead and packaging code. See Ordering Options Table for available options.  
(2) J = 5%, K = 10%, M = 20%  
(3) K = 10%, M = 20%  
(4) H = 2.5%, J = 5%, K = 10%  
(\*) I<sub>rms</sub> value that leads to a ΔT of ≈ 20°C on the box surface > T<sub>BOX</sub> = T<sub>AMB</sub> + ΔT = 85°C + 20°C = 105°C

**Table 1 – Ratings & Part Number Reference cont.**

VDC	VAC	Cap Value (µF)	Dimensions in mm			Lead Spacing (S)	dV/dt (V/µs)	Max K <sub>0</sub> (V <sup>2</sup> /µs)	I <sub>pk</sub>	ESL	ESR max	I <sub>rms</sub> max (*)		R <sub>th</sub>	KEMET Internal Part Number	Customer Part Number
										Lead Length 2x 4 mm	at 100 kHz	at 100 kHz, 85°C				
			A <sub>pk</sub>	nH	mΩ				A <sub>rms</sub>		(°C/W)					
2000	700	0.22	14.0	28.0	32.0	27.5	2,000	8,000,000	440	18	5.1	12.30	26	75UR3220(1)40(2)	R75UR3220(1)40(2)	
2000	700	0.27	18.0	33.0	32.0	27.5	2,000	8,000,000	540	18	10.0	9.33	23	75UR3270(1)30(2)	R75UR3270(1)30(2)	
2000	700	0.33	18.0	33.0	32.0	27.5	2,000	8,000,000	660	18	8.2	10.31	23	75UR3330(1)40(2)	R75UR3330(1)40(2)	
2000	700	0.39	22.0	37.0	32.0	27.5	2,000	8,000,000	780	18	8.2	10.86	21	75UR3390(1)30(2)	R75UR3390(1)30(2)	
2000	700	0.47	22.0	37.0	32.0	27.5	2,000	8,000,000	940	18	6.8	11.93	21	75UR3470(1)40(2)	R75UR3470(1)40(2)	
2000	700	0.068	11.0	22.0	41.5	37.5	700	2,800,000	48	20	16.4	6.71	27	75UW2680(1)30(2)	R75UW2680(1)30(2)	
2000	700	0.082	11.0	22.0	41.5	37.5	700	2,800,000	57	20	13.6	7.37	27	75UW2820(1)30(2)	R75UW2820(1)30(2)	
2000	700	0.1	11.0	22.0	41.5	37.5	700	2,800,000	70	20	11.1	8.14	27	75UW3100(1)30(2)	R75UW3100(1)30(2)	
2000	700	0.1	24.0	15.0	41.5	37.5	700	2,800,000	70	20	11.1	8.58	24	75UW3100(1)L3(2)	R75UW3100(1)L3(2)	
2000	700	0.12	11.0	22.0	41.5	37.5	700	2,800,000	84	20	9.3	8.91	27	75UW3120(1)30(2)	R75UW3120(1)30(2)	
2000	700	0.12	24.0	15.0	41.5	37.5	700	2,800,000	84	20	9.3	9.40	24	75UW3120(1)L3(2)	R75UW3120(1)L3(2)	
2000	700	0.15	11.0	22.0	41.5	37.5	700	2,800,000	105	20	7.4	9.97	27	75UW3150(1)30(2)	R75UW3150(1)30(2)	
2000	700	0.15	24.0	15.0	41.5	37.5	700	2,800,000	105	20	7.4	10.51	24	75UW3150(1)L3(2)	R75UW3150(1)L3(2)	
2000	700	0.18	13.0	24.0	41.5	37.5	700	2,800,000	126	20	6.2	11.31	25	75UW3180(1)30(2)	R75UW3180(1)30(2)	
2000	700	0.18	24.0	15.0	41.5	37.5	700	2,800,000	126	20	6.2	11.51	24	75UW3180(1)L3(2)	R75UW3180(1)L3(2)	
2000	700	0.22	13.0	24.0	41.5	37.5	700	2,800,000	154	20	5.1	12.50	25	75UW3220(1)30(2)	R75UW3220(1)30(2)	
2000	700	0.22	24.0	15.0	41.5	37.5	700	2,800,000	154	20	5.1	12.73	24	75UW3220(1)L3(2)	R75UW3220(1)L3(2)	
2000	700	0.27	16.0	28.5	41.5	37.5	700	2,800,000	189	20	10.0	9.41	23	75UW3270(1)30(2)	R75UW3270(1)30(2)	
2000	700	0.27	24.0	19.0	41.5	37.5	700	2,800,000	189	20	10.0	9.34	23	75UW3270(1)L3(2)	R75UW3270(1)L3(2)	
2000	700	0.33	16.0	28.5	41.5	37.5	700	2,800,000	231	20	8.2	10.40	23	75UW3330(1)30(2)	R75UW3330(1)30(2)	
2000	700	0.33	24.0	19.0	41.5	37.5	700	2,800,000	231	20	8.2	10.33	23	75UW3330(1)L3(2)	R75UW3330(1)L3(2)	
2000	700	0.39	19.0	32.0	41.5	37.5	700	2,800,000	273	20	8.2	10.89	21	75UW3390(1)30(2)	R75UW3390(1)30(2)	
2000	700	0.47	19.0	32.0	41.5	37.5	700	2,800,000	329	20	6.8	11.95	21	75UW3470(1)30(2)	R75UW3470(1)30(2)	
2000	700	0.56	20.0	40.0	41.5	37.5	700	2,800,000	392	20	5.7	13.70	19	75UW3560(1)40(2)	R75UW3560(1)40(2)	
2000	700	0.68	20.0	40.0	41.5	37.5	700	2,800,000	476	20	4.7	15.09	19	75UW3680(1)30(2)	R75UW3680(1)30(2)	
2000	700	0.82	24.0	44.0	41.5	37.5	700	2,800,000	574	20	3.9	17.29	17	75UW3820(1)40(2)	R75UW3820(1)40(2)	
2000	700	1	24.0	44.0	41.5	37.5	700	2,800,000	700	20	3.2	19.10	17	75UW4100(1)30(2)	R75UW4100(1)30(2)	
VDC	VAC	Cap Value	T	H	L	Lead Spacing (S)	dV/dt (V/µs)	Max K <sub>0</sub> (V <sup>2</sup> /µs)	A <sub>pk</sub>	nH	mΩ	A <sub>rms</sub>	(°C/W)	KEMET Internal Part Number	Customer Part Number	
									I <sub>pk</sub>	Lead Length 2x 4 mm	at 100 kHz	at 100 kHz, 85°C				
			Dimensions						ESL	ESR max	I <sub>rms</sub> max (*)	R <sub>th</sub>				

(1) Insert lead and packaging code. See Ordering Options Table for available options.  
(2) J = 5%, K = 10%, M = 20%  
(3) K = 10%, M = 20%  
(4) H = 2.5%, J = 5%, K = 10%  
(\*) I<sub>rms</sub> value that leads to a ΔT of ≈ 20°C on the box surface > T<sub>BOX</sub> = T<sub>AMB</sub> + ΔT = 85°C + 20°C = 105°C

## Soldering Process

The implementation of the RoHS directive has resulted in the selection of SnAgCu (SAC) alloys or SnCu alloys as a primary solder. This has increased the liquidus temperature from that of 183°C for SnPb eutectic alloy to 217 – 221°C for the new alloys. As a result, the heat stress to the components, even in wave soldering, has increased considerably due to higher pre-heat and wave temperatures. Polypropylene capacitors are especially sensitive to heat (the melting point of polypropylene is 160 – 170°C). Wave soldering can be destructive, especially for mechanically small polypropylene capacitors (with lead spacing of 5 mm to 15 mm), and great care has to be taken during soldering. The recommended solder profiles from KEMET should be used. Please consult KEMET with any questions. In general, the wave soldering curve from IEC Publication 61760–1 Edition 2 serves as a solid guideline for successful soldering. Please see Figure 1.

Reflow soldering is not recommended for through-hole film capacitors. Exposing capacitors to a soldering profile in excess of the above recommended limits may result in degradation or permanent damage to the capacitors.

Do not place the polypropylene capacitor through an adhesive curing oven to cure resin for surface mount components. Insert through-hole parts after the curing of surface mount parts. Consult KEMET to discuss the actual temperature profile in the oven, if through-hole components must pass through the adhesive curing process. A maximum two soldering cycles is recommended. Please allow time for the capacitor surface temperature to return to a normal temperature before the second soldering cycle.

### Manual Soldering Recommendations

The following is recommended for manual soldering with a soldering iron.

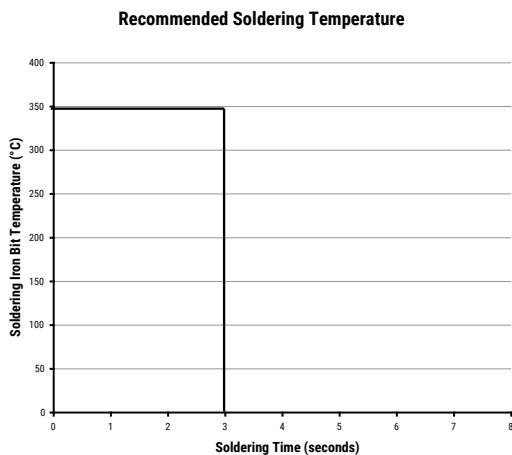

The soldering iron tip temperature should be set at 350°C (+10°C maximum) with the soldering duration not to exceed more than 3 seconds.

### Wave Soldering Recommendations

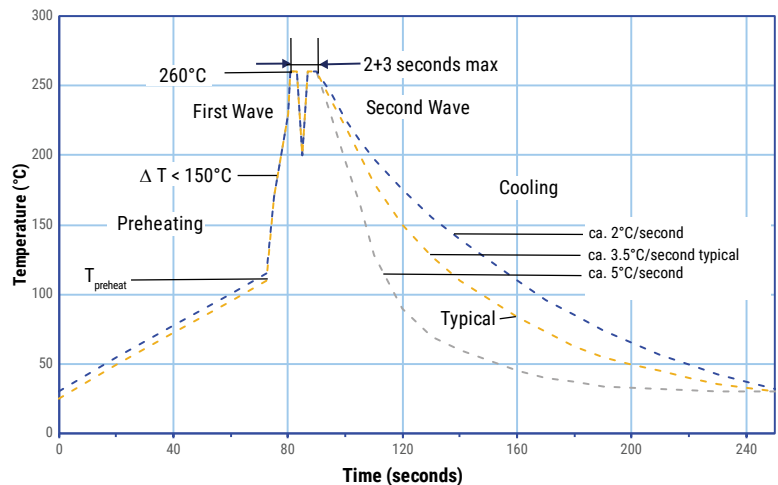

## Soldering Process cont.

### Wave Soldering Recommendations cont.

1. The table indicates the maximum set-up temperature of the soldering process  
Figure 1.

Dielectric Film Material	Maximum Preheat Temperature		Maximum Peak Soldering Temperature	
	Capacitor Pitch ≤ 15 mm	Capacitor Pitch > 15 mm	Capacitor Pitch ≤ 15 mm	Capacitor Pitch > 15 mm
Polyester	130°C	130°C	270°C	270°C
Polypropylene	110°C	130°C	260°C	270°C
Paper	130°C	140°C	270°C	270°C
Polyphenylene Sulphide	150°C	160°C	270°C	270°C

2. The maximum temperature measured inside the capacitor:

Set the temperature so that inside the element the maximum temperature is below the limit:

Dielectric Film Material	Maximum temperature measured inside the element
Polyester	160°C
Polypropylene	110°C
Paper	160°C
Polyphenylene Sulphide	160°C

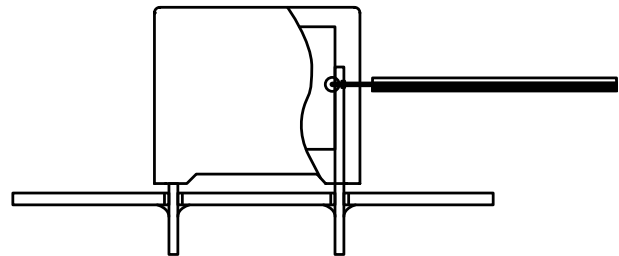

*Temperature monitored inside the capacitor.*

### Selective Soldering Recommendations

Selective dip soldering is a variation of reflow soldering. In this method, the printed circuit board with through-hole components to be soldered is preheated and transported over the solder bath as in normal flow soldering without touching the solder. When the board is over the bath, it is stopped and pre-designed solder pots are lifted from the bath with molten solder only at the places of the selected components, and pressed against the lower surface of the board to solder the components.

The temperature profile for selective soldering is similar to the double wave flow soldering outlined in this document, **however, instead of two baths, there is only one bath with a time from 3 to 10 seconds.** In selective soldering, the risk of overheating is greater than in double wave flow soldering. Great care must be taken so that the parts are not overheated.

## Construction

### 1 Section

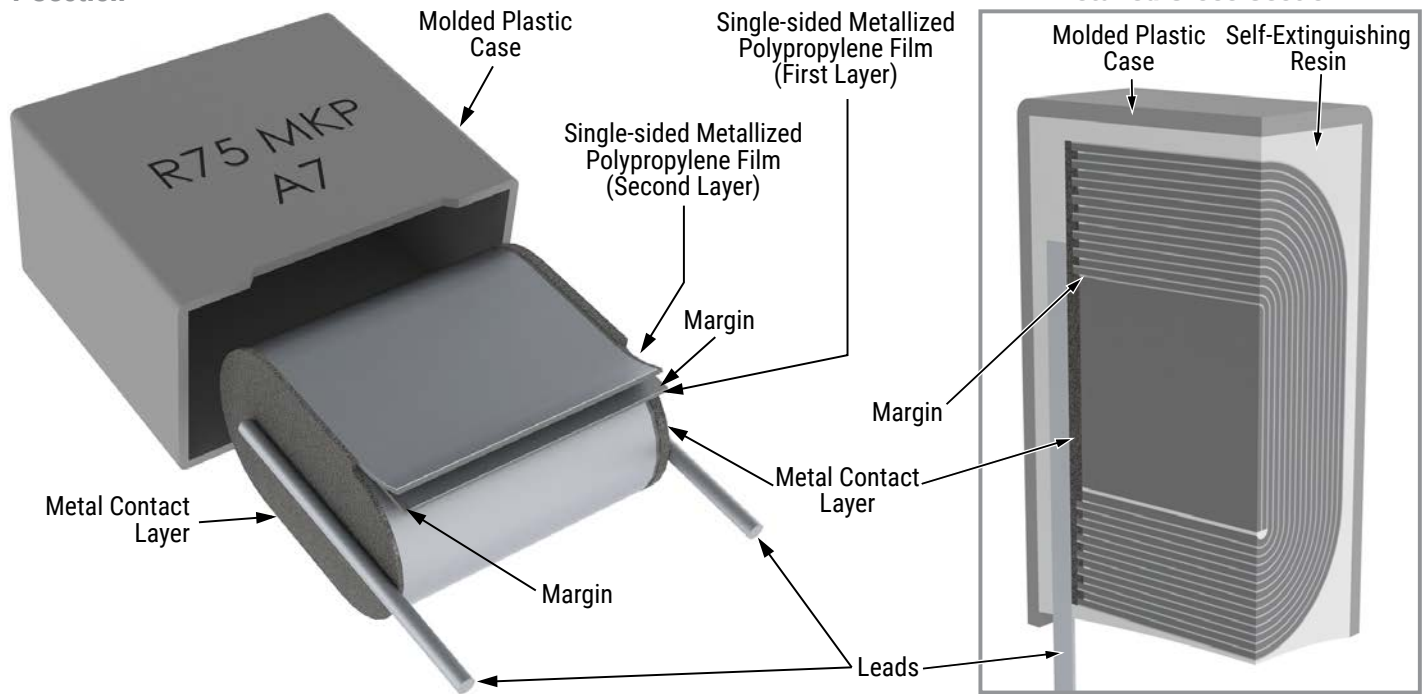

### Winding Scheme

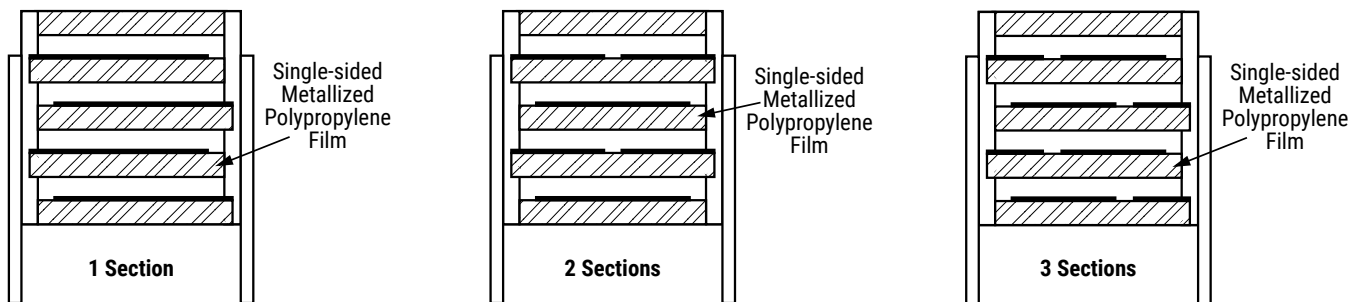

## Marking

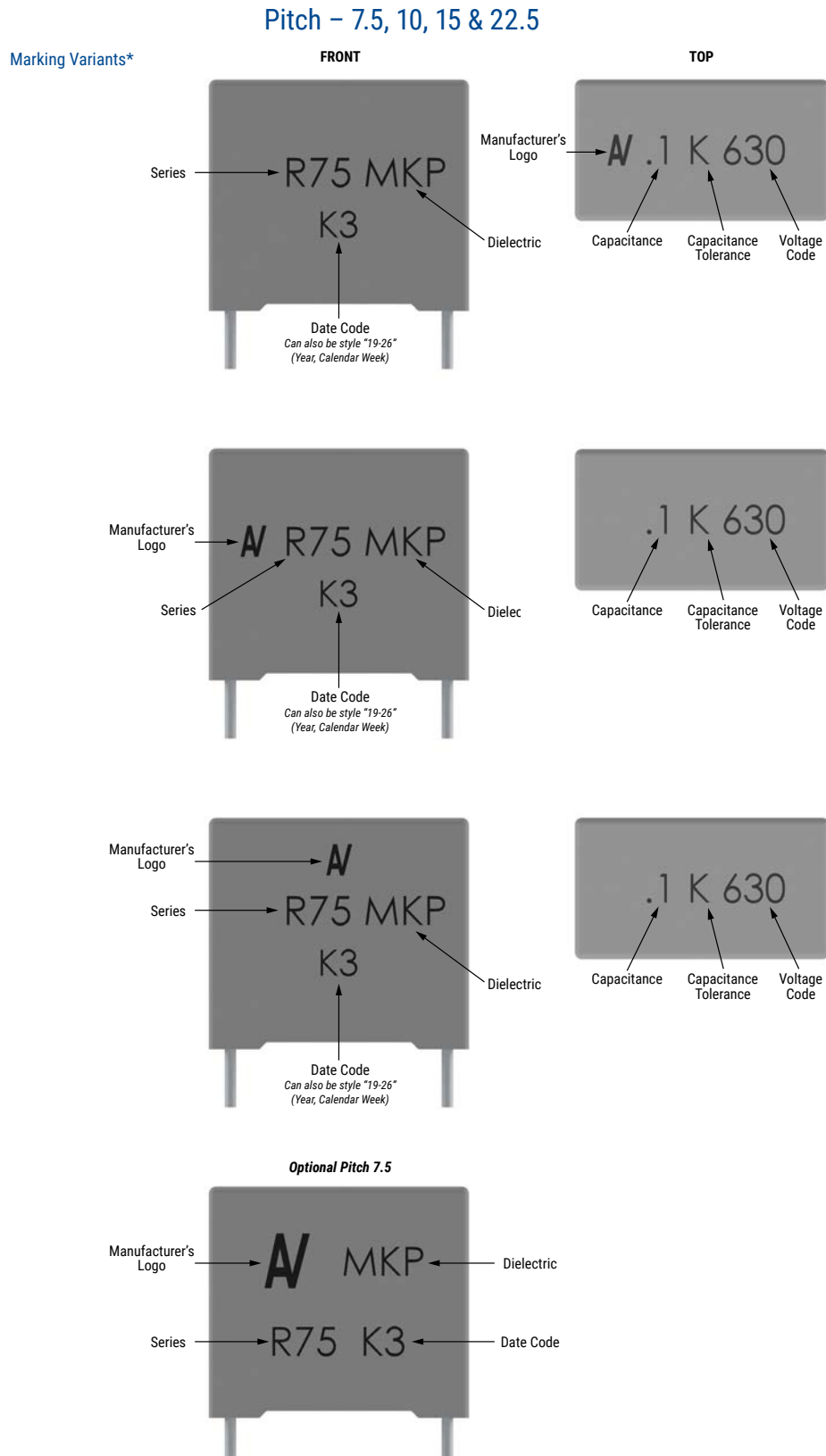

\* Differences are caused by technology (clichee, laser or ink jet) and technic (production line)

**Marking cont.**

Pitch – 7.5, 10, 15, 22.5, 27.5 & 37.5

Marking Variants\*

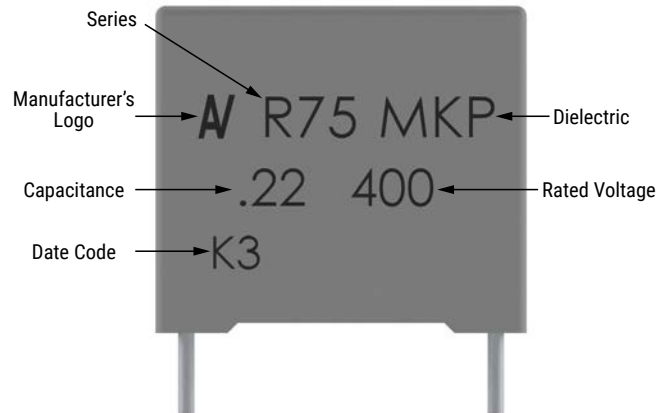
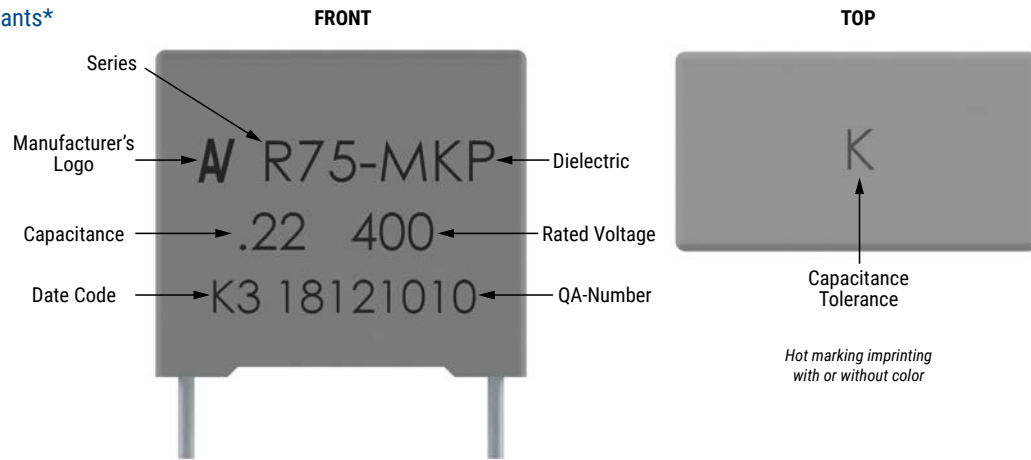

Pitch – 22.5, 27.5 & 37.5

Marking Variants\*

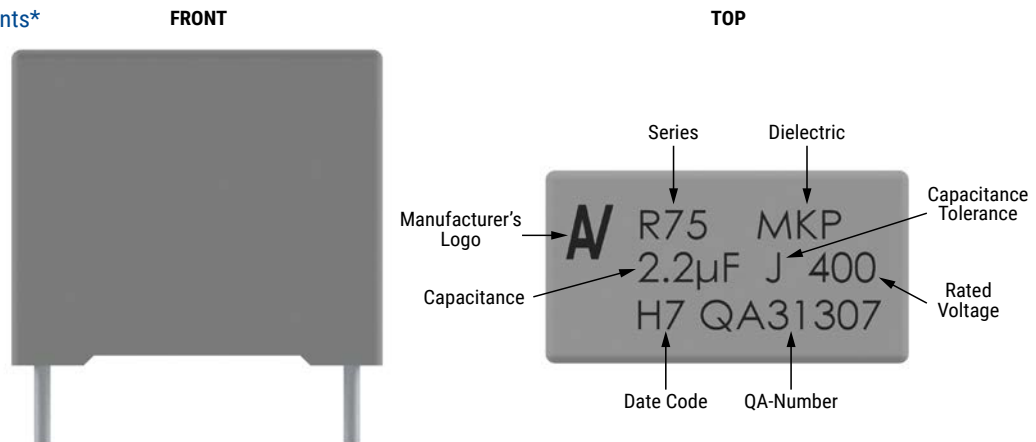

\* Differences are caused by technology (clichee, laser or ink jet) and technic (production line)

**Marking cont.**

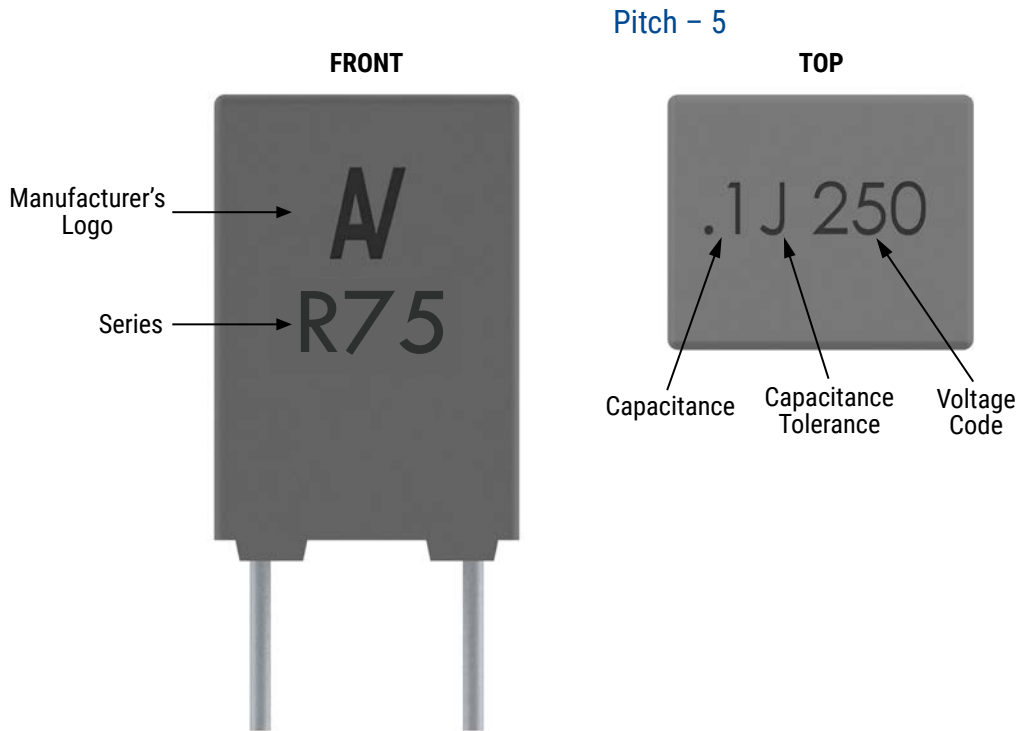

\* Differences are caused by technology (clichee, laser or ink jet) and technic (production line)

Manufacturing Date Code (IEC-60062)			
Year	Code	Month	Code
2010	A	January	1
2011	B	February	2
2012	C	March	3
2013	D	April	4
2014	E	May	5
2015	F	June	6
2016	H	July	7
2017	J	August	8
2018	K	September	9
2019	L	October	0
2020	M	November	N
2021	N	December	D
2022	P		
2023	R		
2024	S		
2025	T		
2026	U		
2027	V		
2028	W		
2029	X		
2030	A		

## Packaging Quantities

Lead Spacing	Thickness (mm)	Height (mm)	Length (mm)	Bulk Short Leads	Bulk Long Leads		Standard Reel ø 355 mm	Large Reel ø 500 mm	Ammo Taped
	Lead and Packaging Code			AA - JA - JB JE - JH	Z3 <sup>1</sup> - JM <sup>2</sup>	40 - 50	GY - CK <sup>1</sup>	CK	DQ
5	3.5	7.5	7.2	2,000	3,000	-	1,800	-	2,500
	4.5	9.5	7.2	1,500	2,000	-	1,400	-	1,900
	5.0	10.0	7.2	1,000	1,500	-	1,200	-	1,700
	6.0	11.0	7.2	2,000	1,000	-	1,000	-	1,400
	7.2	13.0	7.2	1,500	750	-	800	-	1,150
7.5	3.0	8.0	10.0	1,500	1,750	-	2,100	-	2,800
	4.0	9.0	10.0	2,000	1,500	-	1,500	-	2,100
	5.0	10.5	10.0	1,500	1,000	-	1,200	-	1,600
	6.0	12.0	10.5	1,000	800	-	1,000	-	1,350
10	4.0	9.0	13.0	2,000	2,200	1,800	750	1,500	1,000
	5.0	11.0	13.0	1,300	2,000	1,500	600	1,250	800
	6.0	12.0	13.0	1,000	1,800	1,200	500	1,000	680
15	4.0	10.0	18.0	2,500	1,500	1,500	750	1,500	1,000
	5.0	11.0	18.0	2,000	1,250	1,000	600	1,250	800
	6.0	12.0	18.0	1,750	1,000	900	500	1,000	680
	7.5	13.5	18.0	1,000	800	700	350	800	500
	8.5	14.5	18.0	1,000	650	500	300	700	440
	9.0	12.5	18.0	1,000	700	520	270	650	410
	10.0	16.0	18.0	750	550	500	270	600	380
	11.0	19.0	18.0	450	400	350	270	500	340
22.5	6.0	15.0	26.5	805	450	500	300	700	464
	7.0	16.0	26.5	700	450	500	250	550	380
	8.5	17.0	26.5	468	350	300	250	450	280
	10.0	18.5	26.5	396	350	300	160	350	235
	11.0	20.0	26.5	360	200	250	160	350	217
	13.0	22.0	26.5	300	150	200	130	300	-
	14.5	29.5	26.5	264	120	-	-	-	-
27.5	9.0	17.0	32.0	816	-	408	230	450	-
	11.0	20.0	32.0	560	-	336	190	350	-
	13.0	12.0	32.0	672	-	288	-	-	-
	13.0	22.0	32.0	480	-	288	150	300	-
	13.0	25.0	32.0	480	-	288	-	300	-
	14.0	28.0	32.0	352	-	176	-	-	-
	18.0	33.0	32.0	256	-	128	-	-	-
	22.0	37.0	32.0	168	-	112	-	-	-
37.5	11.0	22.0	41.5	420	-	252	-	-	-
	13.0	24.0	41.5	360	-	216	-	-	-
	16.0	28.5	41.5	216	-	108	-	-	-
	19.0	32.0	41.5	192	-	96	-	-	-
	20.0	40.0	41.5	126	-	84	-	-	-
	24.0	15.0	41.5	252	-	108	-	-	-
	24.0	19.0	41.5	216	-	108	-	-	-
	24.0	44.0	41.5	108	-	72	-	-	-
30.0	45.0	41.5	90	-	60	-	-	-	

1 Only 7.5 mm lead spacing: CK.  
2 Only for > 7.5 mm lead spacing.

## Lead Taping & Packaging (IEC 60286-2)

Figure 1 – Lead Spacing 5 & 7.5 mm

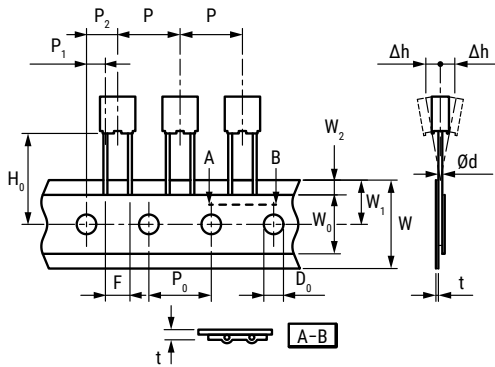

Figure 2 – Lead Spacing 10 & 15 mm

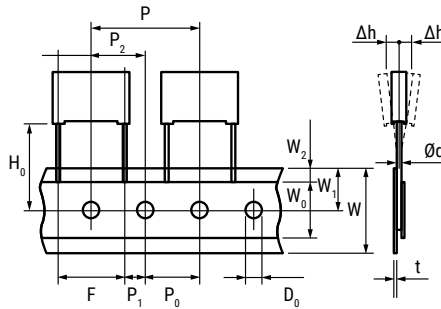
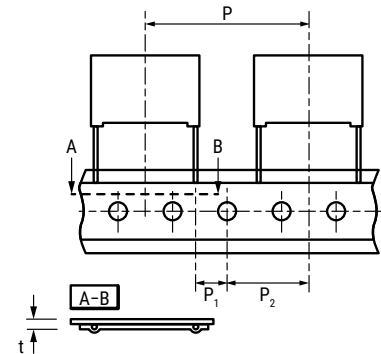

Figure 3 – Lead Spacing 22.5 & 27.5 mm



## Taping Specification

Description	Symbol	Dimensions (mm)						Tolerance
		Lead Spacing						
		5.0 Figure 1	7.5 Figure 1	10.0 Figure 2	15.0 Figure 2	22.5 Figure 3	27.5 Figure 3	
Lead wire diameter	d	0.5	0.5 – 0.6	0.6	0.6 – 0.8	0.8	0.8	±0.05
Taping lead space	P	12.7	12.7	25.4	25.4	38.1	38.1	±1
Feed hole lead space *	P <sub>0</sub>	12.7	12.7	12.7	12.7	12.7	12.7	±0.2 **
Centering of the lead wire	P <sub>1</sub>	3.85	2.6	7.7	5.2	7.8	5.3	±0.7
Centering of the body	P <sub>2</sub>	6.35	6.35	12.7	12.7	19.05	19.05	±1.3
Lead spacing ***	F	5.0	7.5	10.0	15.0	22.5	27.5	+0.6/-0.1
Component alignment	Δh	0	0	0	0	0	0	±2
Component deviation	Δp	0	0	0	0	0	0	±1
Height of component from tape center	H <sub>0</sub> ****	18.5	18.5	18.5	18.5	18.5	18.5	±0.5
Carrier tape width	W	18	18	18	18	18	18	+1/-0.5
Hold down tape width	W <sub>0</sub>	6	6	9	10	10	10	Minimum
Hole position	W <sub>1</sub>	9	9	9	9	9	9	±0.5
Hold down tape position	W <sub>2</sub>	3	3	3	3	3	3	Maximum
Feed hole diameter	D <sub>0</sub>	4	4	4	4	4	4	±0.2
Total tape thickness	t	0.7	0.7	0.7	0.7	0.7	0.7	±0.2

\* Available also 15 mm.

\*\* Maximum 1 mm on 20 lead spacing.

\*\*\* 15 mm and 10 mm taped to 7.5 mm (crimped leads) available upon request.

\*\*\*\* H<sub>0</sub> = 16.5 mm is available upon request.

## Lead Taping & Packaging (IEC 60286-2) cont.

### Ammo Specifications

Dimensions (mm)		
H	W	T
360	340	59

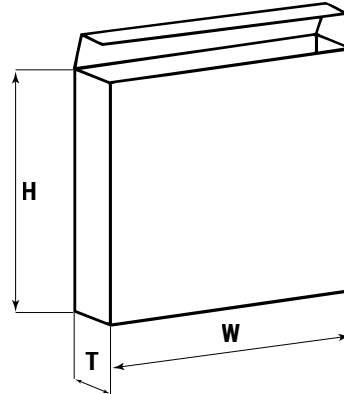

### Reel Specifications

Dimensions (mm)		
D	H	W
355	30	55 Maximum
500	25	

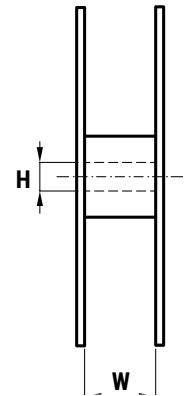
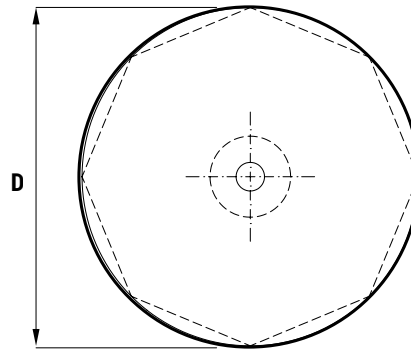

## KEMET Electronics Corporation Sales Offices

For a complete list of our global sales offices, please visit [www.kemet.com/sales](http://www.kemet.com/sales).

---

### Disclaimer

All product specifications, statements, information and data (collectively, the "Information") in this datasheet are subject to change. The customer is responsible for checking and verifying the extent to which the Information contained in this publication is applicable to an order at the time the order is placed. All Information given herein is believed to be accurate and reliable, but it is presented without guarantee, warranty, or responsibility of any kind, expressed or implied.

Statements of suitability for certain applications are based on KEMET Electronics Corporation's ("KEMET") knowledge of typical operating conditions for such applications, but are not intended to constitute – and KEMET specifically disclaims – any warranty concerning suitability for a specific customer application or use. The Information is intended for use only by customers who have the requisite experience and capability to determine the correct products for their application. Any technical advice inferred from this Information or otherwise provided by KEMET with reference to the use of KEMET's products is given gratis, and KEMET assumes no obligation or liability for the advice given or results obtained.

Although KEMET designs and manufactures its products to the most stringent quality and safety standards, given the current state of the art, isolated component failures may still occur. Accordingly, customer applications which require a high degree of reliability or safety should employ suitable designs or other safeguards (such as installation of protective circuitry or redundancies) in order to ensure that the failure of an electrical component does not result in a risk of personal injury or property damage.

Although all product-related warnings, cautions and notes must be observed, the customer should not assume that all safety measures are indicated or that other measures may not be required.

*KEMET is a registered trademark of KEMET Electronics Corporation.*