

# WLF12 Pro Flexible LED Strip Light Instruction Manual



Original Instructions  
p/n: 234631 Rev. A  
October 17, 2023

© Banner Engineering Corp. All rights reserved.

# Contents

## Chapter 1 Features

Pro Editor.....	3
Models .....	4

<b>Chapter 2 Wiring.....</b>	<b>5</b>
------------------------------	----------

<b>Chapter 3 Cutting Instructions.....</b>	<b>7</b>
--	----------

<b>Chapter 4 Mounting Instructions .....</b>	<b>9</b>
--	----------

## Chapter 5 Specifications

FCC Part 15 Class A .....	12
Industry Canada ICES-003(A).....	13
Dimensions.....	13

## Chapter 6 Accessories

LC25 Pro Controllers .....	15
Mounting Accessories.....	15
Cordsets .....	16
Splitter Cordsets .....	17

<b>Chapter 7 Banner Engineering Corp Limited Warranty .....</b>	<b>19</b>
---	-----------

Chapter Contents

Pro Editor ..... 3  
Models ..... 4

# Chapter 1 Features

Banner’s WLF12 Pro Flexible LED Strip Light has been engineered to integrate easily into a broad range of industrial applications and environments. Its rugged yet flexible housing can be cut to length, allowing users to customize the light to their ideal shape. The light installs easily with integral high-strength adhesive tape, for creative use on an AGV, machine, or assembly station. The programmable RGB LEDs offer proven durability, a wide range of colors, and animations to fit any indication needs.

- Industrial light with RGB LEDs that provides flexible and bright status indication
- Programmable using Banner's LC25 Pro Controller and controllable using the LC25 Pro Controller with IO-Link
- Pro Editor software configuration and LC25 Pro Controller gives access to color, flashing, intensity, and animation settings, as well as advanced operating modes for displaying distance, count, time, and position
- All models have an M12 connector for plug-and-play indication
- Low-profile, space-saving design
- Rugged, water-resistant design, suitable for damp location use
- Available in five lengths from 300 mm to 2000 mm
- Very high-bonding strength tape pre-applied to the back of the light to mount the WLF12 without mounting brackets
- Optional brackets are available for an even more secure installation and positioning
- Both straight and curved installation possible

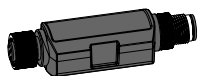
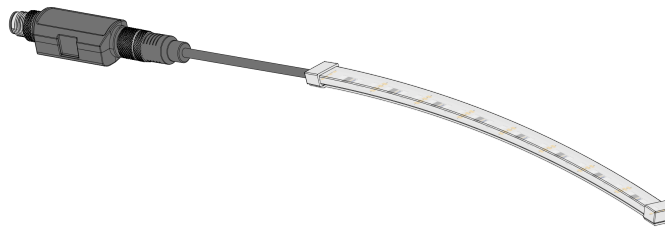

To connect the light to Banner's Pro Editor Software, use with the LC25C-WLF12-RGB7Q controller. To connect the light to an IO-Link master, use with the LC25C-WLF12-KQ controller. For more information, refer to the LC25 Pro Controller datasheet, p/n 234627.

**IMPORTANT:** Read the following instructions before operating the light. Please download the complete WLF12 Pro Flexible LED Strip Light technical documentation, available in multiple languages, from [www.bannerengineering.com](http://www.bannerengineering.com) for details on the proper use, applications, Warnings, and installation instructions of this device.

## Pro Editor



Use Banner's Pro Editor software and Pro Converter Cable to create custom configurations by selecting different colors, flash patterns, and animations. For more information visit [www.bannerengineering.com/proeditor](http://www.bannerengineering.com/proeditor).

**IMPORTANT:** The WLF12 needs an LC25C-WLF12-RGB7Q to connect to the Pro Editor software.

# Models

*Model Key*

Family	Style	Cascade	Color	Lighted Length (mm)	Construction	Connector <sup>(1)</sup>
<b>WLF12</b>	<b>P</b>	<b>X</b>	<b>RGB</b>	<b>300</b>	<b>S</b>	<b>QP</b>
WLF12	P = Pro	X = Non-cascadable	RGB = RGB Multicolor	300 = 300 mm	S = Sealed (IP66, IP67, IP69K per DIN 40050-9)	QP = 150 mm (6 in) PVC-jacketed cable with a 4-pin M12 male quick-disconnect connector
				600 = 600 mm		
				900 = 900 mm		
				1200 = 1200 mm		
				2000 = 2000 mm		

<sup>(1)</sup> Models with a quick-disconnect connector require a mating cordset.

Chapter Contents

# Chapter 2 Wiring

## WLF12 Wiring

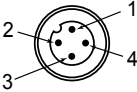
4-pin Male M12 Pinout	Pinout Key and Wiring
	<ol style="list-style-type: none"> <li>1. Brown - 12 V DC</li> <li>2. White - BI</li> <li>3. Blue - DC Common</li> <li>4. Black - DI</li> </ol>

## LC25C with WLF12 Wiring<sup>(1)</sup>

### Pro Controller Wiring

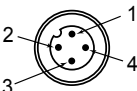
4-pin Male M12 Pinout	Pinout Key and Wiring <sup>(2)</sup>
	<ol style="list-style-type: none"> <li>1. Brown - Input 1: 12 V DC to 30 V DC</li> <li>2. White - Input 3: 12 V DC to 30 V DC</li> <li>3. Blue - DC Common</li> <li>4. Black - Input 2: 12 V DC to 30 V DC</li> </ol>

### Pro Controller with IO-Link Wiring

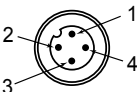
4-pin Male M12 Pinout	Pinout Key and Wiring
	<ol style="list-style-type: none"> <li>1. Brown - 18 V DC to 30 V DC</li> <li>2. White - Not used</li> <li>3. Blue - DC Common</li> <li>4. Black - IO-Link Communication</li> </ol>

<sup>(1)</sup> Contact the factory for instructions on how to use a WLF12 without an LC25C.

<sup>(2)</sup> Input functionality can change depending on the configuration created with Pro Editor. Refer to wiring diagrams in the selected mode in Pro Editor.

*Blank page*

## Chapter 3 Cutting Instructions

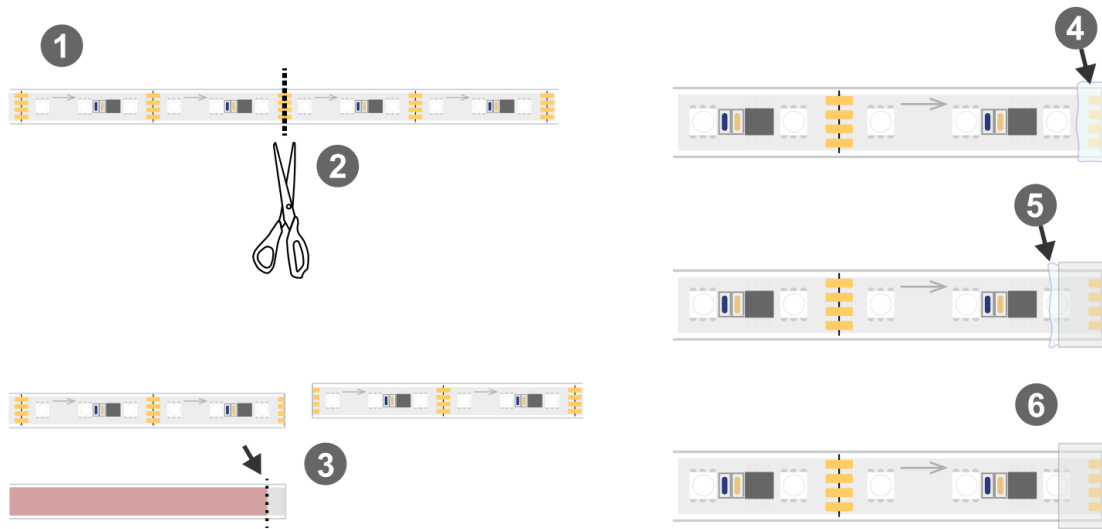

1. Prepare the flexible LED strip light.
2. Cut along one of the cutting lines located between each section of three LEDs.
3. Peel back part of the tape on the back, and trim it off.
4. Cover the cut end of the light with silicone glue.
5. Take the extra supplied silicone end cap, and put it on the end of the light. Press out excess glue.
6. Clean the light of the excess glue.
7. Allow twenty-four hours for the glue to dry.
8. Perform a remote teach operation, if applicable, or set the new number of sections of light through software using the LG25 Pro Controller.

*Blank page*

Chapter Contents

# Chapter 4 Mounting Instructions

Before installation: gather all supporting parts and accessories and remove power from the light.

1. Clean the mounting surface. Ensure that the mounting surface and all other mounting installation parts are dry.

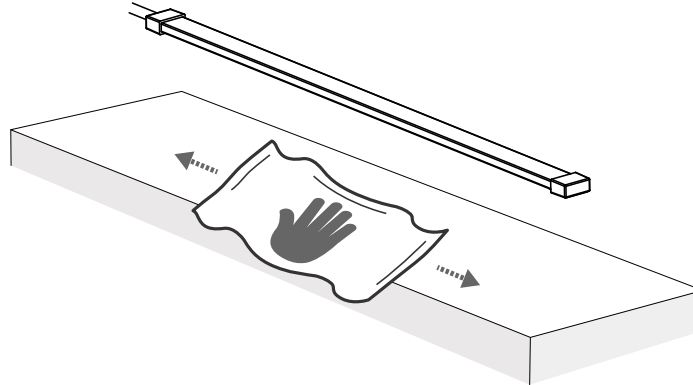

2. Remove the protective liner from the tape on the back of the light strip.

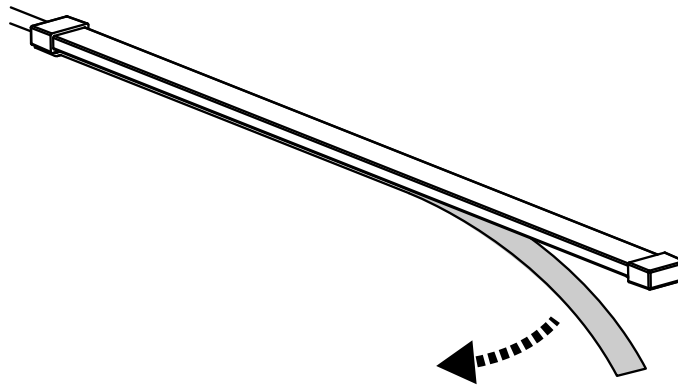

3. Align the light strip in the desired installation position, and press the light strip firmly onto the mounting surface. After installing the light strip, wait twenty-four hours for the tape to adhere completely to the mounting surface. Do not touch or move the light strip during this time period.

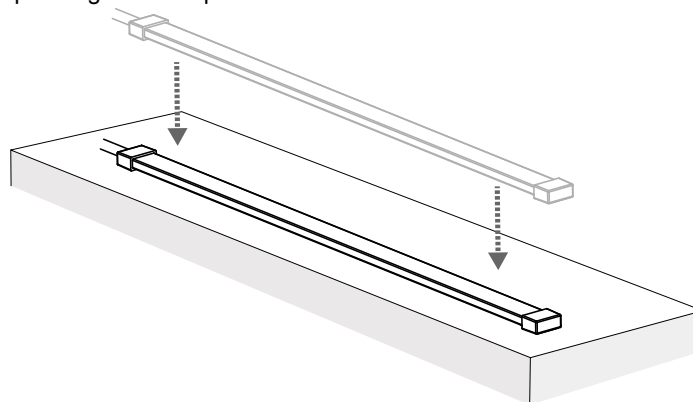

4. Connect the light strip to the controller.
5. Connect the controller to the control device.

6. Confirm that the installation is fastened, the wiring is correct, and that the waterproof connecting wire for docking is tightened.
7. Apply power to the light and the controller.

Chapter Contents

FCC Part 15 Class A ..... 12  
 Industry Canada ICES-003(A)..... 13  
 Dimensions..... 13

# Chapter 5 Specifications

### Supply Voltage

Input voltage without a controller: 12 V DC (±10%)  
 Input voltage with LC25 Pro Controller: 12 V DC to 30 V DC  
 Input voltage with LC25 Pro Controller with IO-Link: 18 V DC to 30 V DC  
 Use only with a suitable Class 2 power supply (UL) or SELV power supply (CE)

**NOTICE:** The WLF12 is designed to be used with an LC25C and must be no more than 3.05 m (10 ft) apart. Contact the factory for instructions on how to use a WLF12 without an LC25C.

 **WARNING:** The WLF12 will be permanently damaged if a supply voltage of greater than 12 V DC is applied directly to the light.

### Supply Current

Light Length	WLF12 Only Typical Current (A)	WLF12 + LC25C Typical (A)			
		12 V DC	12 V DC	18 V DC	24 V DC
300 mm	0.195	0.225	0.17	0.135	0.115
600 mm	0.39	0.42	0.31	0.24	0.2
900 mm	0.585	0.615	0.45	0.345	0.285
1200 mm	0.78	0.81	0.59	0.45	0.37
2000 mm	1.3	1.33	0.965	0.73	0.6

### Supply Protection Circuitry

When a WLF12 is paired with an LC25C, it is protected against reverse polarity and transient voltages  
 See electrical characteristics on product label

### Connections

150 mm (6 in) PVC-jacketed cable with a 4-pin M12 male quick-disconnect connector  
 Models with a quick-disconnect require a mating cordset  
 Do not spray cable with high-pressure sprayer or cable damage will result.

### Operating Temperature

-20 °C to +45 °C (-4 °F to +113 °F)

### Storage Temperature

-35 °C to +70 °C (-31 °F to +158 °F)

### Environmental Rating

Rated IP66, IP67, IP69K per DIN 40050-9  
 Suitable for damp locations per UL 2108  
 Do not spray cable with a high-pressure sprayer or cable damage will result.

### Vibration and Mechanical Shock

Vibration: 10 Hz to 55 Hz, 1.0 mm peak-to-peak amplitude per IEC 60068-2-6  
 Shock: 15G 11 ms duration, half sine wave per IEC 60068-2-27

### Construction

Clear silicone outer housing and end caps  
 Internally silicone-encapsulated LEDs  
 Very high-bonding strength tape and protective liner pre-applied to the back of the light

### Application Notes

When cutting the WLF12, it is important to use the extra end cap supplied along with silicone glue. See "[Cutting Instructions](#)" on page 7  
 Multiple WLF12s can be connected with a splitter cable to a single LC25C. Note that each WLF12 displays the same color and animation settings. Do not connect more than 2000 mm (78.74 in) in total length to an LC25C.  
 For indoor or outdoor use, if exposure to direct sunlight is avoided.

### Minimum Bend Radius

15 mm

### Required Overcurrent Protection

 **WARNING:** Electrical connections must be made by qualified personnel in accordance with local and national electrical codes and regulations.

Overcurrent protection is required to be provided by end product application per the supplied table.

Overcurrent protection may be provided with external fusing or via Current Limiting, Class 2 Power Supply.

Supply wiring leads < 24 AWG shall not be spliced.

For additional product support, go to [www.bannerengineering.com](http://www.bannerengineering.com).

Supply Wiring (AWG)	Required Overcurrent Protection (A)	Supply Wiring (AWG)	Required Overcurrent Protection (A)
20	5.0	26	1.0
22	3.0	28	0.8
24	1.0	30	0.5

**Mounting**

Use pre-applied, very high-bonding strength tape to mount the WLF12 without mounting brackets, see "[Mounting Instructions](#)" on page 9  
 If needed, use mounting bracket LMBWLF12C, see "[Mounting Accessories](#)" on page 15

**Certifications**



Banner Engineering BV  
 Park Lane, Culliganlaan 2F bus 3  
 1831 Diegem, BELGIUM



Turck Banner LTD Blenheim House  
 Blenheim Court  
 Wickford, Essex SS11 8YT  
 GREAT BRITAIN



**Light Characteristics**

Sections of three LEDs can be individually controlled at a time  
 LED Pitch: 16.67 mm  
 Beam Angle: 120°  
 RGB LED PWM Frequency: 2 kHz

Color	Dominant Wavelength (nm) or Color Temperature (CCT)	Color Coordinates <sup>(1)</sup>		Lumens at Specified Length (Typical at 25 °C)				
		X	Y	300 mm	600 mm	900 mm	1200 mm	2000 mm
Daylight White	5000K	0.345	0.352	85	170	255	340	565
Incandescent White	2700K	0.46	0.411	70	140	210	280	465
Warm White	3000K	0.44	0.404	75	150	225	300	500
Fluorescent Light	4100K	0.376	0.374	90	180	270	360	600
Neutral White	5700K	0.328	0.337	85	170	255	340	565
Cool White	6500K	0.314	0.324	85	170	255	340	565
Green	520	0.144	0.703	55	110	165	220	365
Red	618	0.686	0.312	30	60	90	120	200
Yellow	575	0.45	0.482	80	160	240	320	530
Blue	464	0.142	0.044	10	20	30	40	65
Magenta	-	0.363	0.162	35	70	105	140	230
Cyan	494	0.143	0.365	60	120	180	240	400
Amber	590	0.543	0.415	55	110	165	220	365
Rose	-	0.529	0.234	30	60	90	120	200
Lime Green	561	0.367	0.542	75	150	225	300	500
Orange	603	0.62	0.36	40	80	120	160	265
Sky Blue	487	0.143	0.26	65	130	195	260	430
Violet	-	0.18	0.076	20	40	60	80	130
Spring Green	509	0.144	0.66	60	120	180	240	400

**FCC Part 15 Class A**

This equipment has been tested and found to comply with the limits for a Class A digital device, pursuant to part 15 of the FCC Rules. These limits are designed to provide reasonable protection against harmful interference when the equipment is

<sup>(1)</sup> Refer to the CIE 1931 (x,y) Chromaticity Diagram to show equivalent color with indicated color coordinates. Actual coordinates may differ ± 5%.

operated in a commercial environment. This equipment generates, uses, and can radiate radio frequency energy and, if not installed and used in accordance with the instruction manual, may cause harmful interference to radio communications. Operation of this equipment in a residential area is likely to cause harmful interference in which case the user will be required to correct the interference at his own expense.

## Industry Canada ICES-003(A)

This device complies with CAN ICES-3 (A)/NMB-3(A). Operation is subject to the following two conditions: 1) This device may not cause harmful interference; and 2) This device must accept any interference received, including interference that may cause undesired operation.

Cet appareil est conforme à la norme NMB-3(A). Le fonctionnement est soumis aux deux conditions suivantes : (1) ce dispositif ne peut pas occasionner d'interférences, et (2) il doit tolérer toute interférence, y compris celles susceptibles de provoquer un fonctionnement non souhaité du dispositif.

## Dimensions

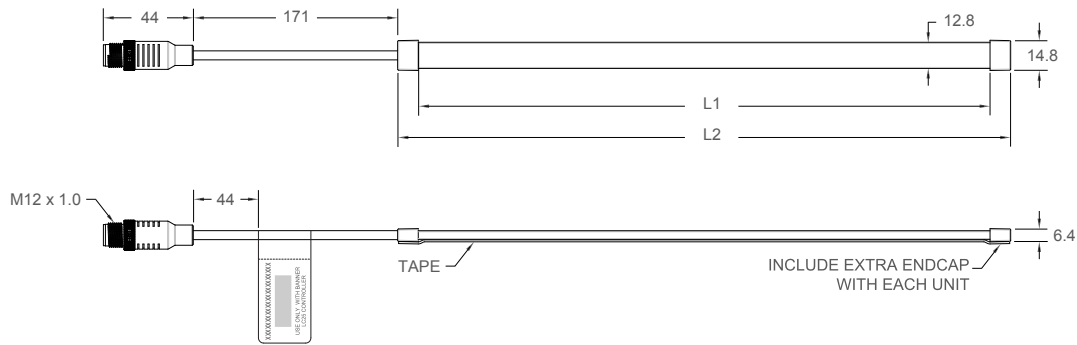

Models	L1	L2
WLF12..300..	300 mm (11.81 in)	325 mm (12.8 in)
WLF12..600..	600 mm (23.6 in)	625 mm (24.61 in)
WLF12..900..	900 mm (35.43 in)	925 mm (36.42 in)
WLF12..1200..	1200 mm (47.24 in)	1225 mm (48.23 in)
WLF12..2000..	2000 mm (78.74 in)	2025 mm (79.72 in)

*Blank page*

Chapter Contents

LC25 Pro Controllers ..... 15  
 Mounting Accessories ..... 15  
 Cordsets ..... 16  
 Splitter Cordsets ..... 17

# Chapter 6 Accessories

## LC25 Pro Controllers

**LC25C-WLF12-RGB7Q**

- In-line LC25 Pro Controller with M12 connectors
- Pro Editor software configuration and three discrete inputs gives access to color, flashing, intensity, and animation settings, as well as advanced operating modes for displaying distance, count, time and position

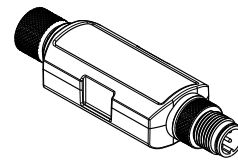

**LC25C-WLF12-KQ**

- In-line LC25 Pro Controller with IO-Link and M12 connectors
- IO-Link gives full access to LED control, color, flashing, intensity, and animation settings, as well as advanced level, gauge, and segment operating modes

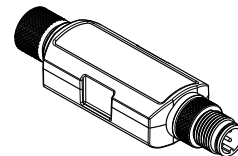

## Mounting Accessories

**LMBWLF12C**

- Set of 10 clamp brackets
- Translucent silicone
- Designed for M3 or No. 4 mounting hardware

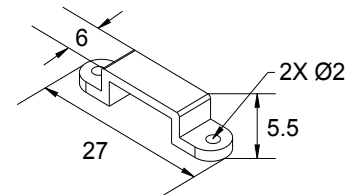

## Cordsets

4-Pin Threaded M12 Cordsets—Single Ended				
Model	Length	Style	Dimensions	Pinout (Female)
MQDC-403	1 m (3.28 ft)	Straight		
MQDC-406	2 m (6.56 ft)			
MQDC-410	3 m (9.8 ft)			
MQDC-406RA	2 m (6.56 ft)	Right-Angle		

- 1 = Brown
- 2 = White
- 3 = Blue
- 4 = Black
- 5 = Unused

4-Pin Threaded M12 Cordsets—Double Ended				
Model	Length	Style	Dimensions	Pinout
MQDEC-401SS	0.31 m (1 ft)	Male Straight/ Female Straight		Female
MQDEC-402SS	0.6 m (1.97 ft)			
MQDEC-403SS	0.91 m (2.99 ft)			
MQDEC-406SS	1.83 m (6 ft)			
MQDEC-410SS	3 m (9.4 ft)			
				Male

- 1 = Brown
- 2 = White
- 3 = Blue
- 4 = Black

# Splitter Cordsets

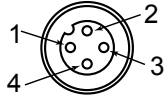
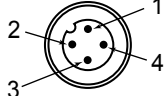
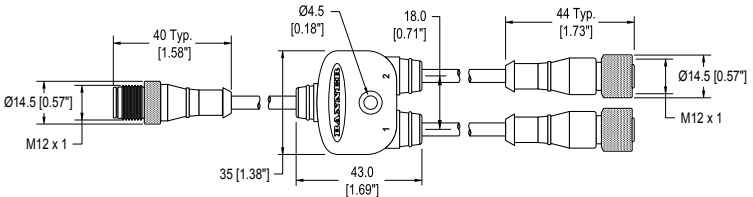
4-Pin Threaded M12 Splitter Cordsets—Flat Junction			
Model	Branches (Female)	Trunk (Male)	Pinout
CSB-M1240M1240	No branch	No trunk	<p>Female</p>  <p>Male</p>  <p>1 = Brown 2 = White 3 = Blue 4 = Black</p>
CSB-M1240M1241	2 × 0.3 m (1 ft)	No trunk	
CSB-M1241M1241	2 × 1 m (3.28 ft)	0.30 m (1 ft)	
CSB-M1243M12413	2 × 1 m (3.28 ft)	1 m (3.28 ft)	
CSB-M1248M1241	2 × 0.3 m (1 ft)	2.44 m (8 ft)	
			

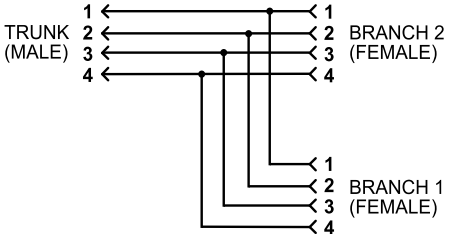
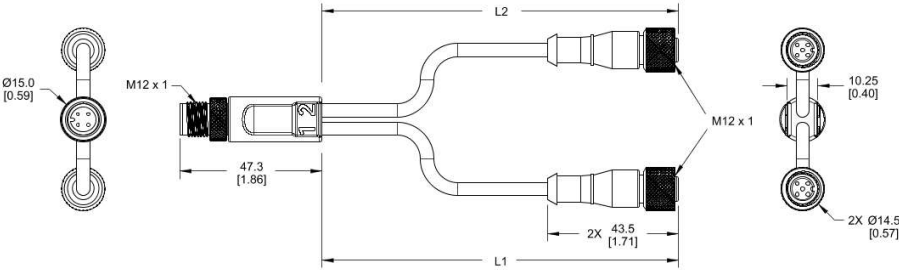
4-Pin Threaded M12 Male to 5-Pin Threaded M12 Female Splitter Cordset		
Model	Branches (Female)	Wiring
S15YB-M124-M124-0.2M	<p><b>L1, L2</b> 2 × 0.2 m (7.9 in)</p>	
		

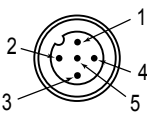
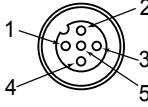
5-Pin Threaded M12 Splitter Cordset with Flat Junction—Double Ended				
Model	Trunk (Male)	Branches (Female)	Pinout (Male)	Pinout (Female)
CSB4-M1251M1250	0.3 m (0.98 ft)	Four (no cable)		

Continued on page 18

Continued from page 17

**5-Pin Threaded M12 Splitter Cordset with Flat Junction—Double Ended**

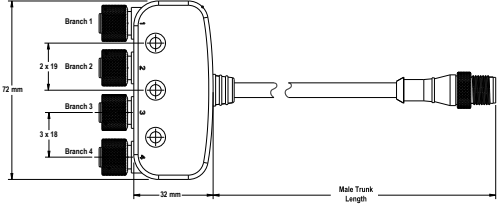
Model	Trunk (Male)	Branches (Female)	Pinout (Male)	Pinout (Female)
			<p>1 = Brown 2 = White 3 = Blue</p>	<p>4 = Black 5 = Gray</p>

Chapter Contents

## Chapter 7 **Banner Engineering Corp Limited Warranty**

---

Banner Engineering Corp. warrants its products to be free from defects in material and workmanship for one year following the date of shipment. Banner Engineering Corp. will repair or replace, free of charge, any product of its manufacture which, at the time it is returned to the factory, is found to have been defective during the warranty period. This warranty does not cover damage or liability for misuse, abuse, or the improper application or installation of the Banner product.

**THIS LIMITED WARRANTY IS EXCLUSIVE AND IN LIEU OF ALL OTHER WARRANTIES WHETHER EXPRESS OR IMPLIED (INCLUDING, WITHOUT LIMITATION, ANY WARRANTY OF MERCHANTABILITY OR FITNESS FOR A PARTICULAR PURPOSE), AND WHETHER ARISING UNDER COURSE OF PERFORMANCE, COURSE OF DEALING OR TRADE USAGE.**

This Warranty is exclusive and limited to repair or, at the discretion of Banner Engineering Corp., replacement. **IN NO EVENT SHALL BANNER ENGINEERING CORP. BE LIABLE TO BUYER OR ANY OTHER PERSON OR ENTITY FOR ANY EXTRA COSTS, EXPENSES, LOSSES, LOSS OF PROFITS, OR ANY INCIDENTAL, CONSEQUENTIAL OR SPECIAL DAMAGES RESULTING FROM ANY PRODUCT DEFECT OR FROM THE USE OR INABILITY TO USE THE PRODUCT, WHETHER ARISING IN CONTRACT OR WARRANTY, STATUTE, TORT, STRICT LIABILITY, NEGLIGENCE, OR OTHERWISE.**

Banner Engineering Corp. reserves the right to change, modify or improve the design of the product without assuming any obligations or liabilities relating to any product previously manufactured by Banner Engineering Corp. Any misuse, abuse, or improper application or installation of this product or use of the product for personal protection applications when the product is identified as not intended for such purposes will void the product warranty. Any modifications to this product without prior express approval by Banner Engineering Corp will void the product warranties. All specifications published in this document are subject to change; Banner reserves the right to modify product specifications or update documentation at any time. Specifications and product information in English supersede that which is provided in any other language. For the most recent version of any documentation, refer to: [www.bannerengineering.com](http://www.bannerengineering.com).

For patent information, see [www.bannerengineering.com/patents](http://www.bannerengineering.com/patents).

 [LinkedIn](#)

 [Twitter](#)

 [Facebook](#)

