

12 A overvoltage protected AC Switch

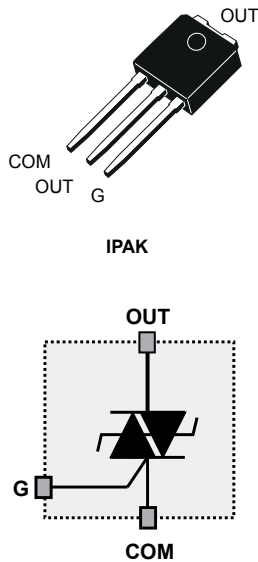

Features

- 12 A AC Switch with self-overvoltage protection
- High junction temperature: $T_j \text{ max.} = 150 \text{ }^\circ\text{C}$
- Symmetric 800 V blocking voltage
- IPAK power package
- Snubberless performance:
 - High static immunity $dV/dt = 1\,000 \text{ V}/\mu\text{s}$ at $150 \text{ }^\circ\text{C}$
 - Strong dynamic commutation: $(di/dt)_c = 9 \text{ A/ms}$ at $150 \text{ }^\circ\text{C}$ (lowercase)
- Halogen-free molding, lead-free plating
- ECOPACK2 power package

Applications

- Inrush current limiting circuits
- Heating resistor control, solid state relays
- Capacitor discharge circuit

Description

The ACST1220H-8H belongs to the ACST power switch family. This high-performance device is suited to home appliances or industrial systems.

This high temperature 12 A AC switch embeds a Triac structure with a high voltage clamping device to absorb the inductive turn-off energy and withstand line transients such as those described in the IEC 61000-4-5 standards.

Offering a low gate current triggering of only 20 mA, it benefits from ST Snubberless technology, enabling high level of noise immunity and turn-off commutation, the ACST1220H-8H eases PCB compliance with EMI standards such as IEC 61000-4-4 (fast transient burst test).

Package environmentally friendly ECOPACK2, RoHS (2011/65/EU) and halogen free compliant.

IPAK Package is UL-94, V0 flammability resin compliance and RoHS (2011/65/EU) compliant.

Product status

ACST1220H-8H

Product summary

$I_{T(RMS)}$	12 A
V_{DRM}/V_{RRM}	800 V
I_{GT}	20 mA
$T_{jmax.}$	$150 \text{ }^\circ\text{C}$

1 Characteristics

Table 1. Absolute maximum ratings (limiting values)

Symbol	Parameter		Value	Unit
$I_{T(RMS)}$	RMS on-state current (full sine wave)		$T_C = 133\text{ }^\circ\text{C}$	12 A
I_{TSM}	Non repetitive surge peak on-state current, (T_j initial = $25\text{ }^\circ\text{C}$)	$t_p = 16.7\text{ ms}$	$T_j = 25\text{ }^\circ\text{C}$	110 A
		$t_p = 20\text{ ms}$		100 A
I^2t	I^2t value for fusing	$t_p = 10\text{ ms}$	$T_j = 25\text{ }^\circ\text{C}$	66 A^2s
di/dt	Critical rate of rise of on-state current, $I_G = 2 \times I_{GT}$, $tr \leq 100\text{ ns}$	$f = 50\text{ Hz}$	$T_j = 25\text{ }^\circ\text{C}$	100 $\text{A}/\mu\text{s}$
V_{DRM} / V_{RRM}	Repetitive peak off-state voltage		$T_j = 150\text{ }^\circ\text{C}$	800 V
$V_{PP}^{(1)}$	Non repetitive line peak pulse voltage		$T_j = 25\text{ }^\circ\text{C}$	2 kV
I_{GM}	Peak forward gate current	$t_p = 20\text{ }\mu\text{s}$	$T_j = 150\text{ }^\circ\text{C}$	1 A
P_{GM}	Peak gate power			10 W
$P_{G(AV)}$	Average gate power dissipation		$T_j = 150\text{ }^\circ\text{C}$	0.1 W
T_{stg}	Storage junction temperature range			-40 to +150 $^\circ\text{C}$
T_j	Operating junction temperature			

1. According to test described by standard IEC 61000-4-5 for a load of $L = 30\text{ }\mu\text{H}$ and $R = 8\text{ Ohm}$, refer to [Figure 14](#).

Table 2. Electrical characteristics ($T_j = 25\text{ }^\circ\text{C}$ unless otherwise specified)

Symbol	Test Conditions	Quadrant	Value		Unit
$I_{GT}^{(1)}$	$V_D = 12\text{ V}$, $R_L = 33\text{ }\Omega$	I-II-III	Min.	1.75	mA
			Max.	20	
V_{GT}			Max.	1	V
V_{GD}	$V_D = 400\text{ V}$, $R_L = 3.3\text{ k}\Omega$, $T_j = 150\text{ }^\circ\text{C}$	I-II-III	Min.	0.2	V
I_L	$I_G = 1.2 \times I_{GT}$	I-II-III	Max.	40	mA
$I_H^{(2)}$	$I_T = 500\text{ mA}$, gate open		Max.	30	mA
$dV/dt^{(2)}$	$V_D = 67\%$ V_{DRM} , gate open, $T_j = 150\text{ }^\circ\text{C}$		Min.	1000	$\text{V}/\mu\text{s}$
$(di/dt)_c^{(2)}$	Without snubber ($dV/dt)_c \geq 20\text{ V}/\mu\text{s}$, $T_j = 150\text{ }^\circ\text{C}$		Min.	9	A/ms
V_{CL}	$I_{CL} = 0.1\text{ mA}$, $t_p = 1\text{ ms}$		Min.	850	V

1. Minimum I_{GT} is guaranteed at 5% of I_{GT} max.
2. For both polarities of OUT referenced to COM.

Table 3. Static Characteristics

Symbol	Test Conditions			Value	Unit
$V_{TM}^{(1)}$	$I_{TM} = 17\text{ A}$, $t_P = 380\ \mu\text{s}$	$T_j = 25\ ^\circ\text{C}$	Max.	1.55	V
$V_{TO}^{(1)}$	Threshold voltage	$T_j = 150\ ^\circ\text{C}$	Max.	0.86	V
$R_D^{(1)}$	Dynamic resistance	$T_j = 150\ ^\circ\text{C}$	Max.	36	m Ω
I_{DRM}/I_{RRM}	$V_D = V_{DRM}$, $V_R = V_{RRM}$	$T_j = 25\ ^\circ\text{C}$	Max.	1	μA
		$T_j = 150\ ^\circ\text{C}$		4.5	mA

1. For both polarities of COM referenced to OUT.

Table 4. Thermal parameters

Symbol	Parameter	Value	Unit
$R_{th(j-c)}$	Junction to case (AC)	Max.	1.2
$R_{th(j-a)}$	Junction to ambient ($S_{Cu} = 1.65\text{ cm}^2$, thickness = 70 μm)	Typ.	70

1.1 Characteristics (curves)

Figure 1. Maximum power dissipation versus on-state RMS current (full cycle)

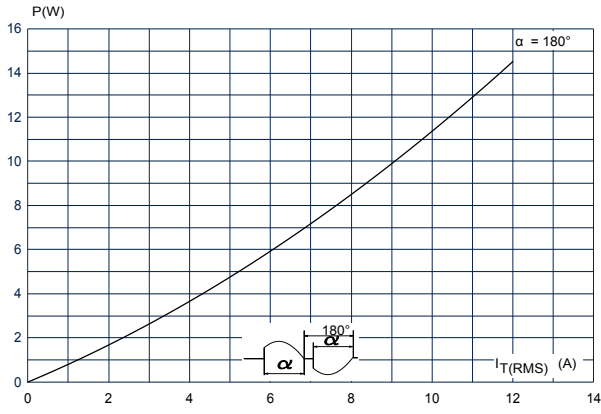

Figure 2. On-state RMS current versus case temperature (full cycle)

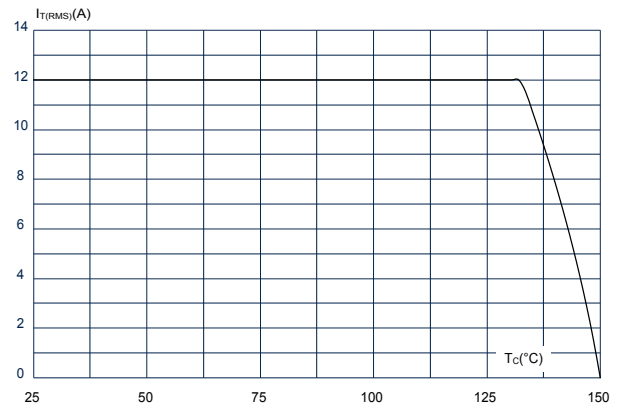

Figure 3. On-state RMS current versus ambient temperature (free air convection)

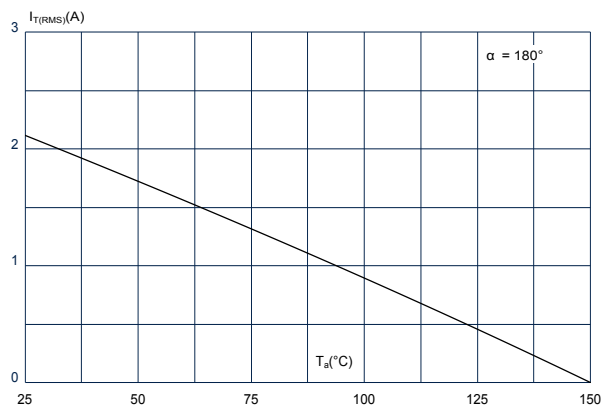

Figure 4. On-state characteristics (maximum values)

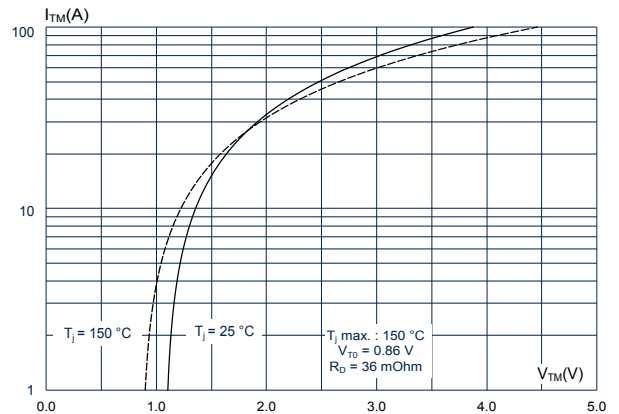

Figure 5. Surge peak on-state current versus number of cycles

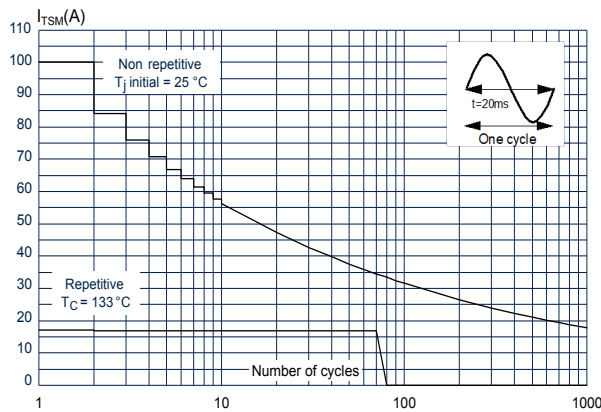

Figure 6. Non repetitive surge peak on-state current for a sinusoidal pulse with width $t_p < 10 \text{ ms}$

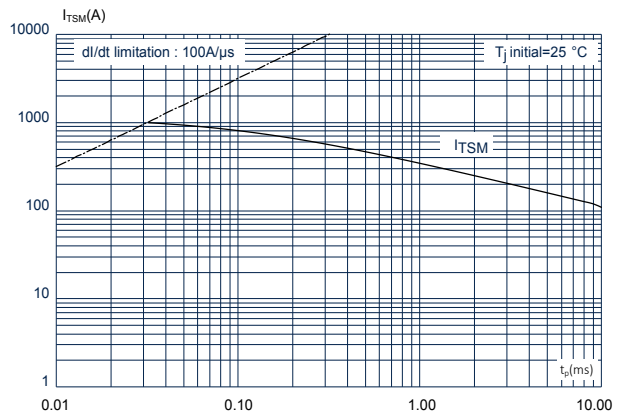

Figure 7. Relative variation of gate trigger current and voltage versus junction temperature (typical values)

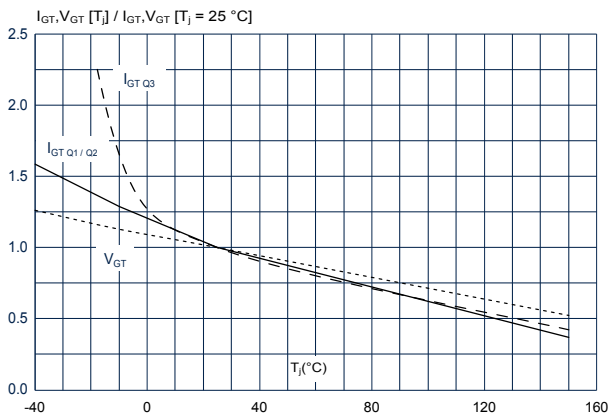

Figure 8. Relative variation of holding and latching current versus junction temperature (typical values)

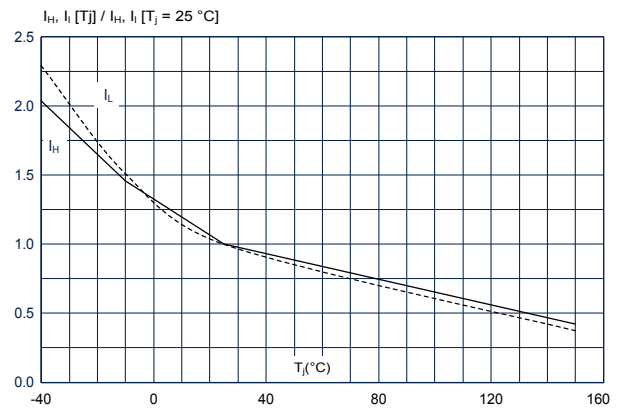

Figure 9. Relative variation of critical rate of decrease of main current versus junction temperature

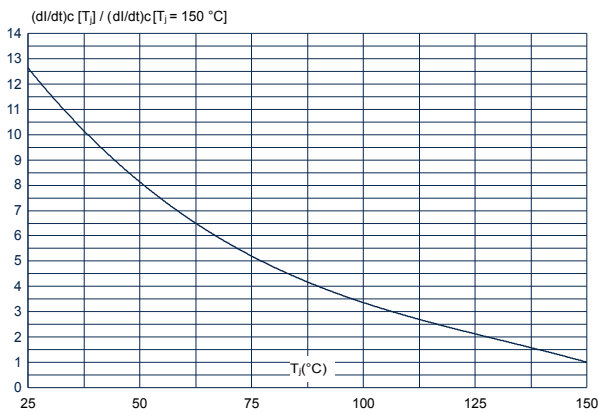

Figure 10. Relative variation of critical rate of decrease of main current (di/dt)_c versus reapplied (dV/dt)_c (typical values)

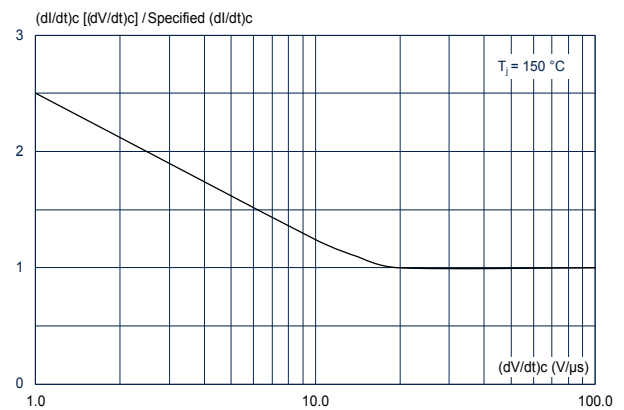

Figure 11. Relative variation of static dV/dt immunity versus junction temperature (typical values)

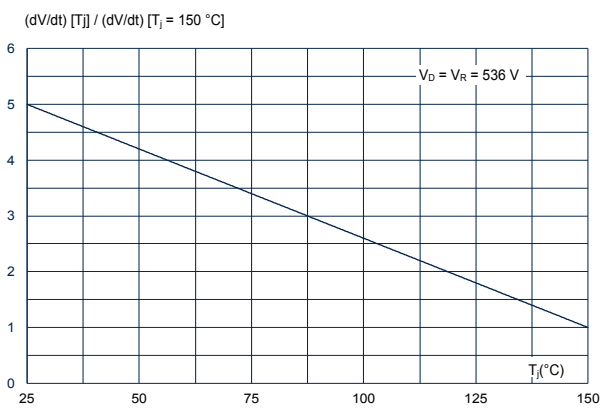

Figure 12. Relative variation of leakage current versus junction temperature

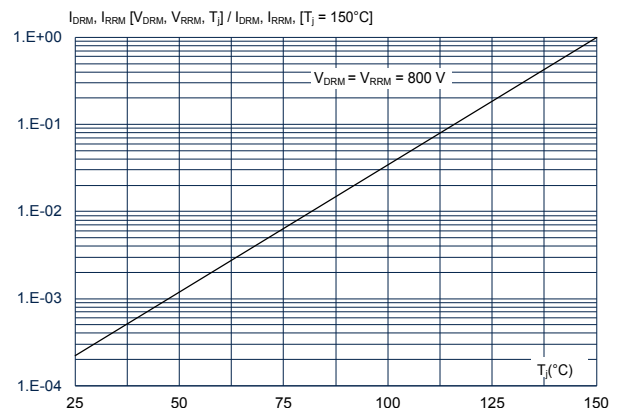
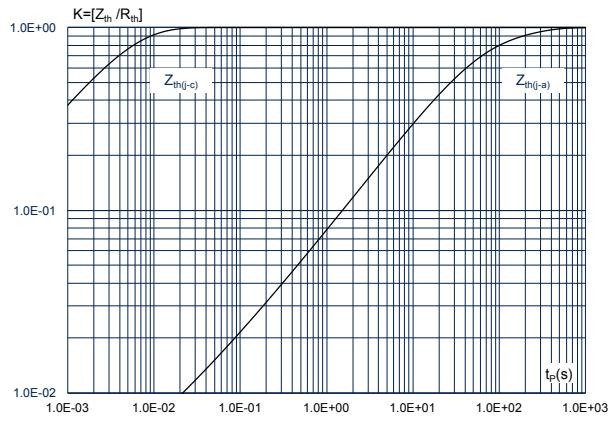

Figure 13. Relative variation of thermal impedance versus pulse duration



2 Application information

AC line transient voltage ruggedness.

In comparison with standard Triac, which need additional protection components against surge voltage, the ACST1220H-8H is self-protected against overvoltage, specified by the parameter V_{CL} . The ACST1220H-8H switch can safely withstand AC line transient voltages either by clamping the low energy spikes, such as the inductive spikes at switchoff, or by switching to the on state (for less than 10 ms) to dissipate higher energy shocks through the load. This safety feature works even with high turn-on current ramp-up.

The test circuit of Figure 14 represents the ACST1220H-8H application, and is used to stress the ACST switch according to the IEC 61000-4-5 standard conditions. With the additional effect of the load which is limiting the current, the ACST switch withstands the voltage spikes up to 2 kV on top of the peak line voltage. The protection is based on an overvoltage crowbar technology.

The ACST1220H-8H folds back safely to the on state as shown in Figure 15. The ACST1220H-8H recovers its blocking voltage capability after the surge and the next zero current crossing. Such a non repetitive test can be done at least 10 times on each AC line voltage polarity.

Figure 14. IEC61000-4-5 standard test schematic load : $R = 8 \text{ Ohm}$, $L = 30 \text{ } \mu\text{H}$, $R_g = 100 \text{ } \Omega$

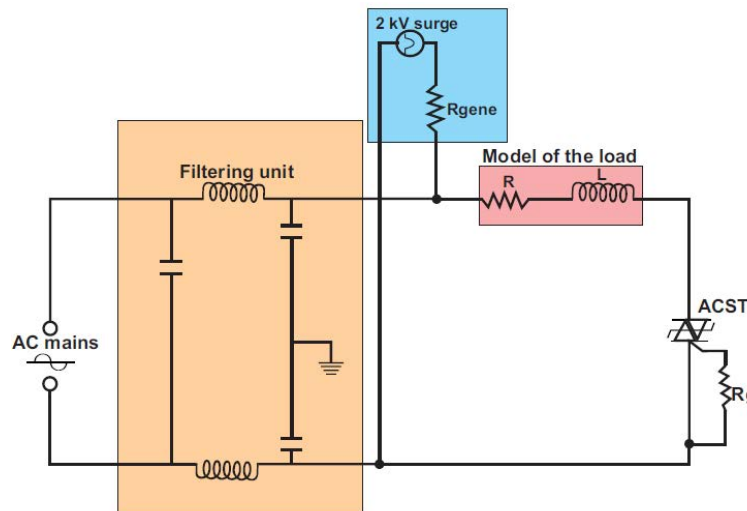
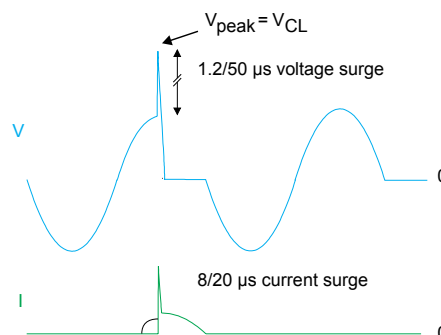

Figure 15. Typical voltage and current waveforms across the ACST1220H-8H during IEC61000-4-5 standard test



3 Package information

In order to meet environmental requirements, ST offers these devices in different grades of **ECOPACK** packages, depending on their level of environmental compliance. ECOPACK specifications, grade definitions and product status are available at: www.st.com. ECOPACK is an ST trademark.

3.1 IPAK package information

- Molding compounded resin is halogen free and meets UL94 flammability standard, level V0
- Lead-free package leads plating

Figure 16. IPAK package outline

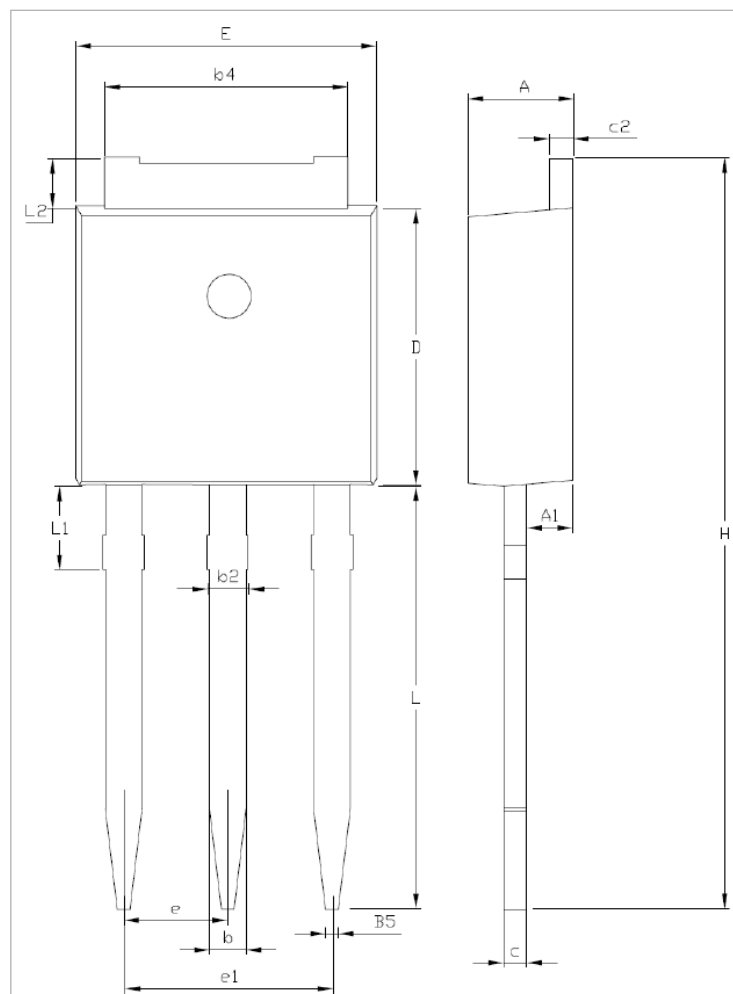

Table 5. IPAK package mechanical data

Ref.	Dimensions					
	MillimetersInches (for reference only)					
	Min.	Typ.	Max.	Min.	Typ.	Max.
A	2.20		2.40	0.086		0.094
A1	0.90		1.10			0.035
b	0.64		0.90	0.025		0.035
b2			0.95			0.037
b4	5.20		5.43			
B5		0.30			0.012	
c	0.45		0.60			
c2	0.46		0.60			
D	6		6.20			
E	6.40		6.65	0.252		0.262
e		2.28			0.090	
e1	4.40		4.60	0.173		0.181
H		16.10			0.634	
L	9		9.60	0.354		0.377
L1	0.8		1.20	0.031		0.047
L2		0.80	1.25		0.031	0.049
V1		10°			10°	

4 Ordering information

Figure 17. Ordering information scheme

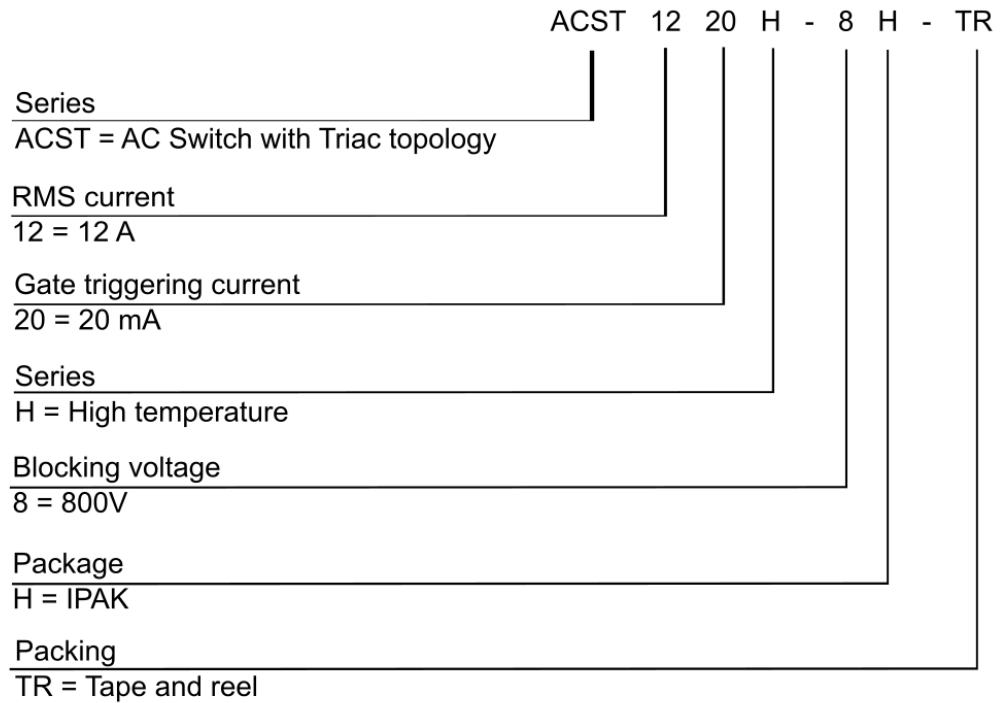

Table 6. Ordering information

Order code	Marking	Package	Weight	Base qty.	Delivery mode
ACST1220H-8H-TR	ACST1220HH	IPAK	1.5 g	1000	Tape and reel

Revision history

Table 7. Document revision history

Date	Revision	Changes
05-Sep-2023	1	Initial release.

IMPORTANT NOTICE – READ CAREFULLY

STMicroelectronics NV and its subsidiaries (“ST”) reserve the right to make changes, corrections, enhancements, modifications, and improvements to ST products and/or to this document at any time without notice. Purchasers should obtain the latest relevant information on ST products before placing orders. ST products are sold pursuant to ST’s terms and conditions of sale in place at the time of order acknowledgment.

Purchasers are solely responsible for the choice, selection, and use of ST products and ST assumes no liability for application assistance or the design of purchasers’ products.

No license, express or implied, to any intellectual property right is granted by ST herein.

Resale of ST products with provisions different from the information set forth herein shall void any warranty granted by ST for such product.

ST and the ST logo are trademarks of ST. For additional information about ST trademarks, refer to www.st.com/trademarks. All other product or service names are the property of their respective owners.

Information in this document supersedes and replaces information previously supplied in any prior versions of this document.

© 2023 STMicroelectronics – All rights reserved