



# TAOGLAS®



# Datasheet

**Part No:**  
**TG.33.8H11W**

**Description:**

Apex TG.33 Ultra-Wideband 5G/4G 600-6000MHz Connector Mount Antenna  
With N-Type Male Connector

**Features:**

600-6000MHz Wideband 5G/4G Cellular Antenna  
Fantastic Efficiency Across all Bands  
Quality Robust IP67 UV Resistant Housing  
Connector: N-Type Male  
Dimensions: 181 \* 49 mm  
RoHS and REACH Compliant

1. Introduction	3
2. Specifications	4
3. Antenna Characteristics	5
4. Radiation Patterns	7
5. Mechanical Drawing	18
6. Packaging	19

---

Changelog

Taoglas makes no warranties based on the accuracy or completeness of the contents of this document and reserves the right to make changes to specifications and product descriptions at any time without notice. Taoglas reserves all rights to this document and the information contained herein. Reproduction, use or disclosure to third parties without express permission is strictly prohibited.



# 1. Introduction



The Apex Straight TG.33 Dipole LTE Antenna – is primarily designed for use with 5G LTE modules and devices that require the highest possible efficiency and peak gain to deliver best in class throughput on all major cellular (5G/4G/3G/2G) bands worldwide for access points, terminals, and routers. The antenna is a ground plane independent antenna with a N type (M) connector and swivel mechanism that allows the antenna part to be rotated around the connector. The Apex exhibits high efficiency across the ultra-wide band and is backward compatible with 2G and 3G cellular applications such as GSM, LTE, UMTS, Wi-Fi and even has GPS included for Assisted GPS and/or E911 applications. With very high efficiency on every cellular band globally it is an ideal solution for any device requiring high, reliable performance. It is also guaranteed to meet any type approval or carrier certification requirements from a RF standpoint. It is an omnidirectional antenna, and the radiation patterns display this and are stable across all bands.

It has a quality robust IP67 UV resistant housing for use with wireless terminals. The swivel mechanism allows the antenna part itself to be orientated in different directions and can help avoid touching off other antennas or objects close by as well as helping with isolation by orientating the antenna in different directions in MIMO systems or when other TG.33 antennas are present on the same device.

Typical Applications include:

- Gateways and Routers
- Cameras and Security
- Public Safety
- Point of Sales Terminals
- Smart Home Automation
- Robotics / Autonomous

The TG.33 comes with a N-Type Male connector as standard and this can be customized subject to MOQ and NRE, contact your regional Taoglas customer support team for more information.

## 2. Specifications

Electrical											
Frequency (MHz)	5G NR B71	LTE 700	LTE B5_B8	5G NR 1500	GNSS L1	5G NR N66	LTE 2600	5G NR N78	5G NR N77	5G NR N79	LTE 5200
	617-698	698-824	824-960	1427-1518	1563-1587	1710-2200	2300-2690	3300-3800	3300-4200	4400-5000	5150-5925
Efficiency (%)											
TG.33.8H11W	63.5	54.5	49.7	76.5	79.6	73.7	78.2	70.4	69.9	71.3	70.6
Average Gain (dB)											
TG.33.8H11W	-1.97	-2.63	-3.04	-1.16	-0.99	-1.32	-1.07	-1.52	-1.56	-1.47	-1.51
Peak Gain (dBi)											
TG.33.8H11W	2.14	2.19	2.20	2.02	2.21	3.80	4.25	4.04	4.04	5.95	4.98
Impedance			50 Ω								
Polarization			Linear								
Radiation Pattern			Omni								
Max. input power			10W								

Mechanical	
Dimensions	181 * 49 mm
Casing	UV Resistant PC/ABS
Flammability Rating	UL-94
Connector	N Type(M)
Environmental	
Temperature Range	-40°C to 85°C
Humidity	Non-condensing 65°C 95% RH

### 3. Antenna Characteristics

#### 3.1 Return Loss

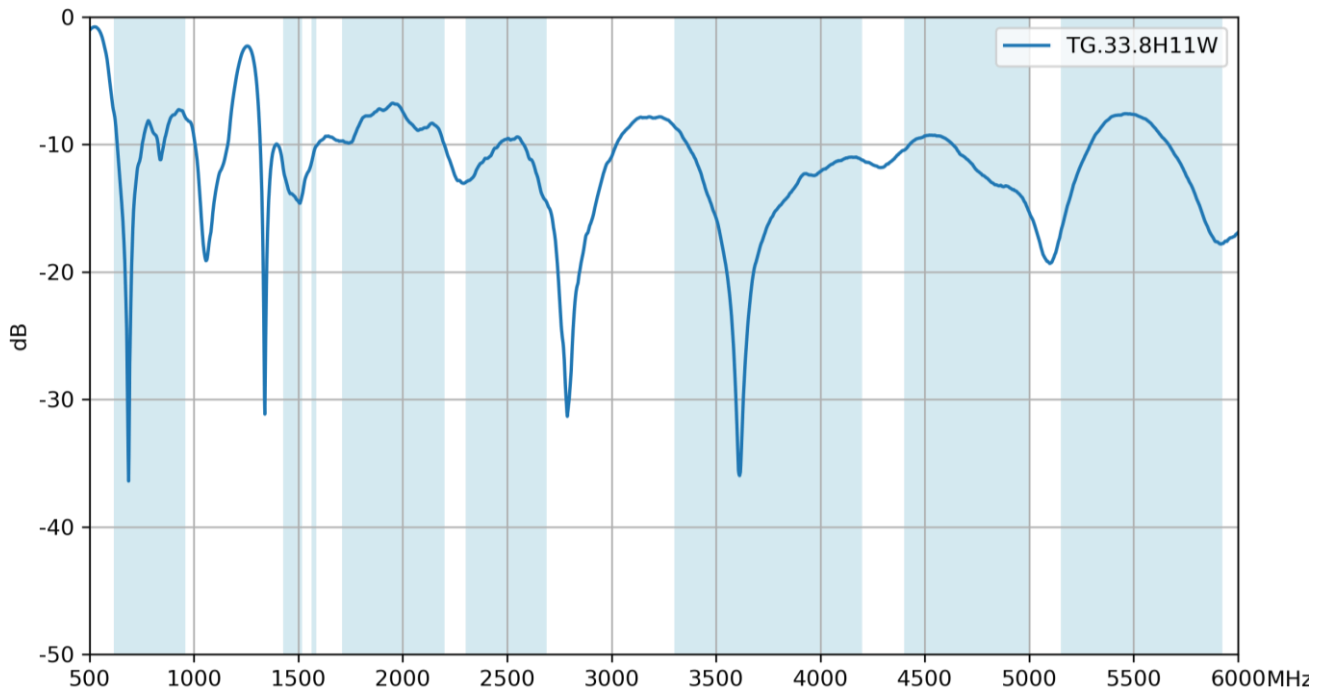

#### 3.2 Efficiency

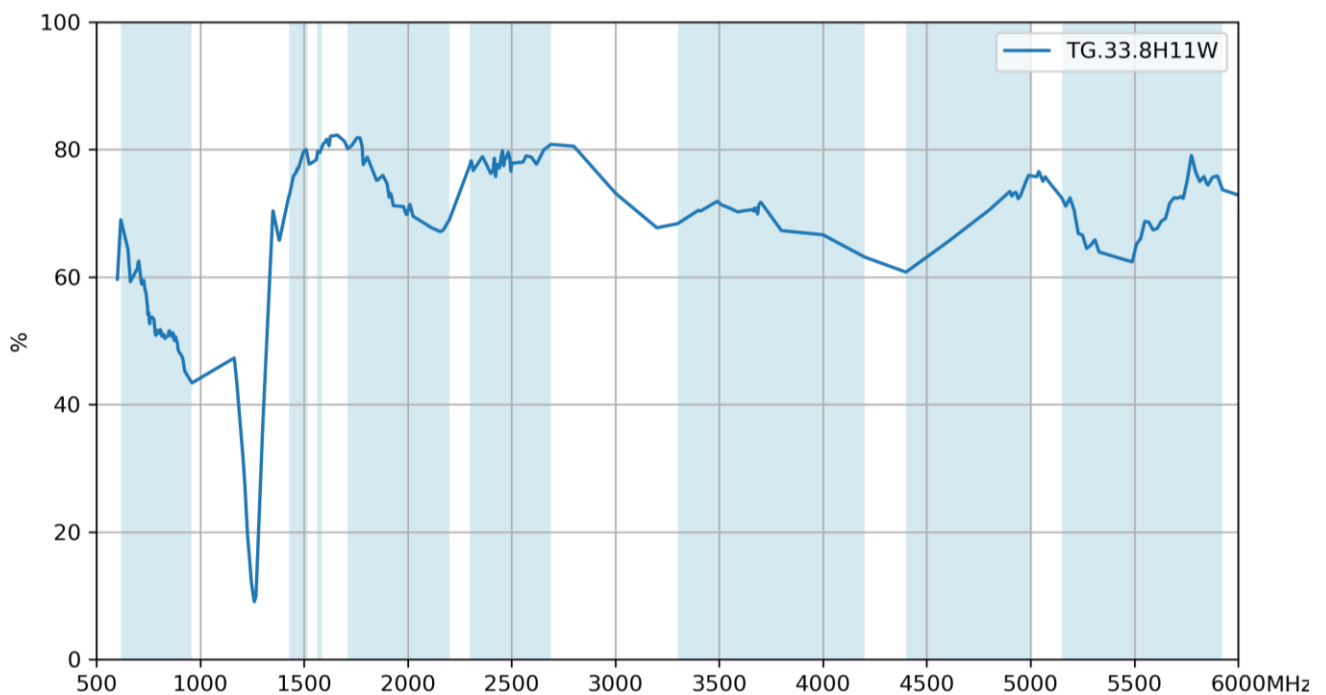

### 3.3 Average Gain

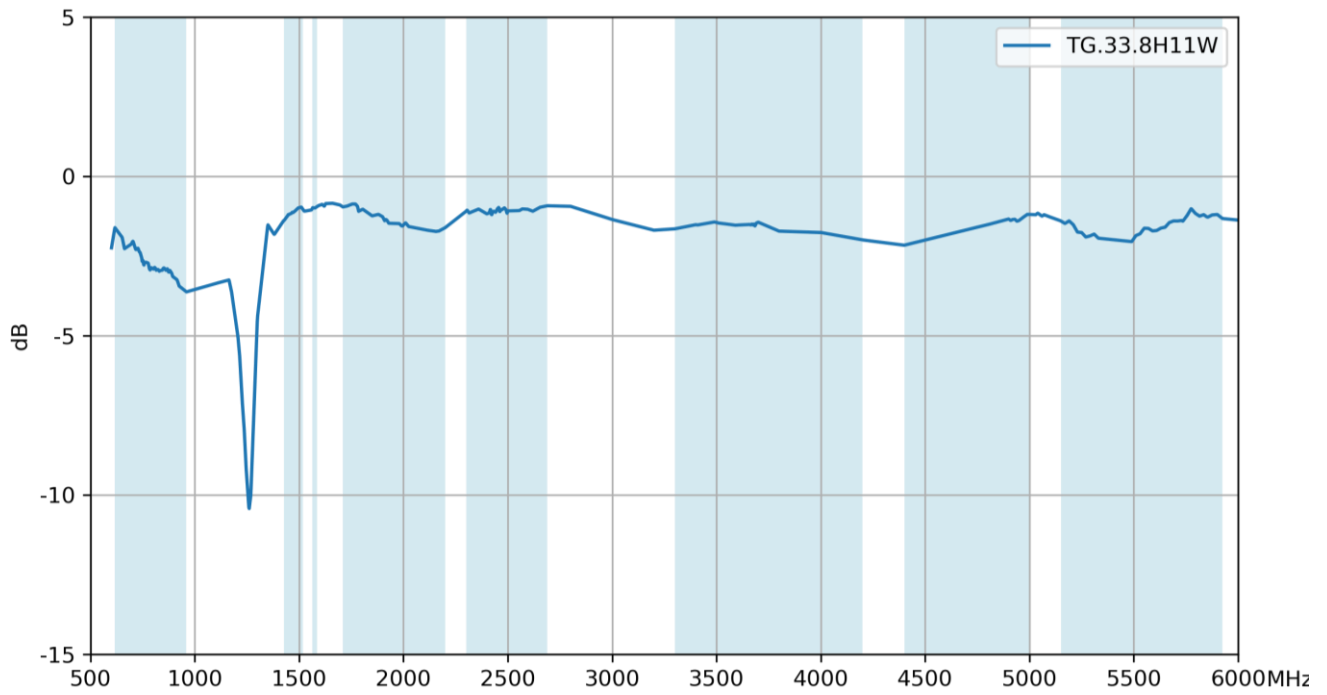

### 3.4 Peak Gain

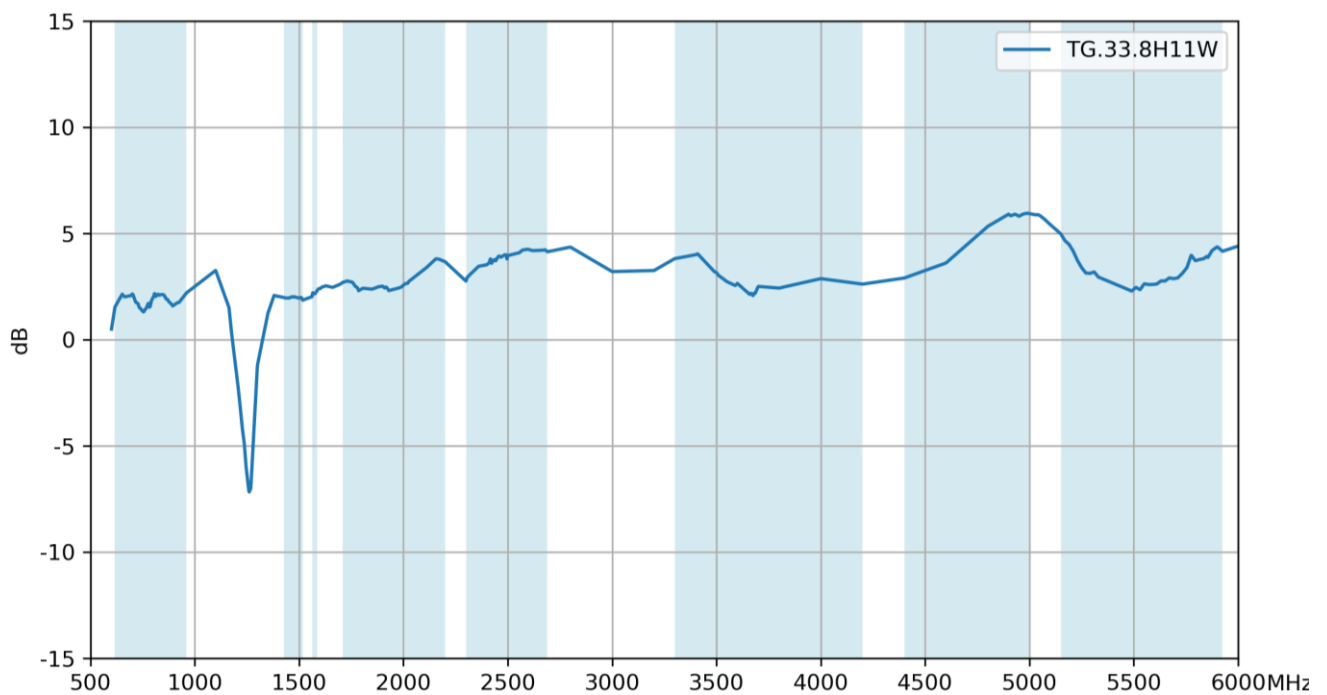

## 4. Radiation Patterns

### 4.1 Test Setup

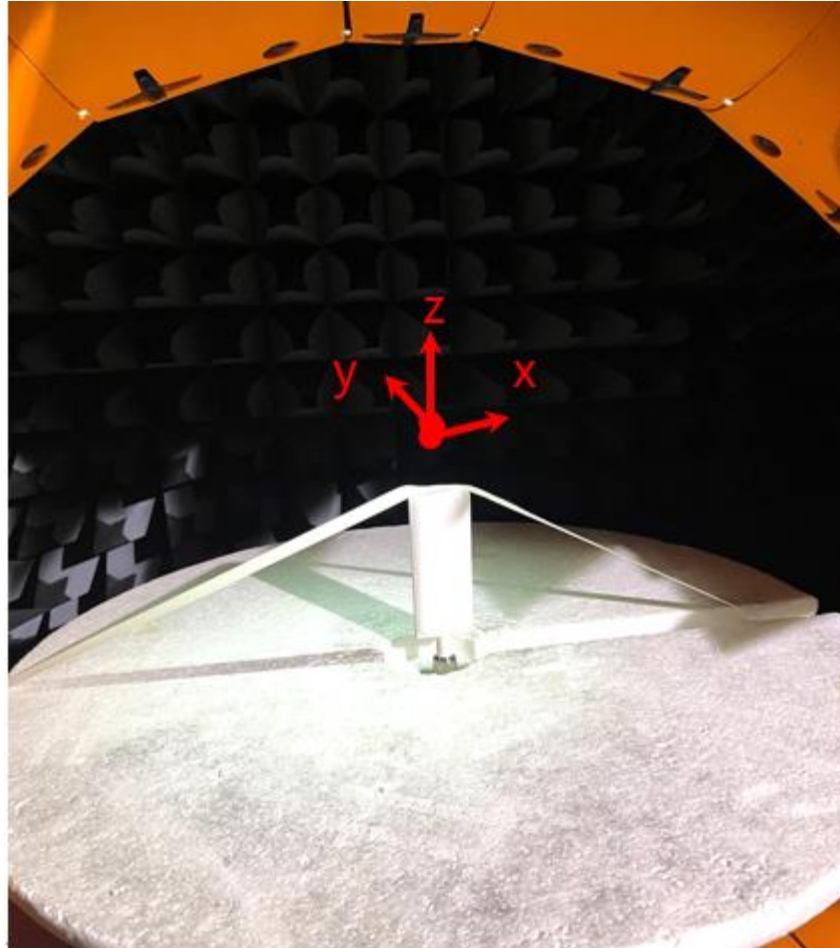

4.2 3D and 2D Radiation Patterns

663MHz

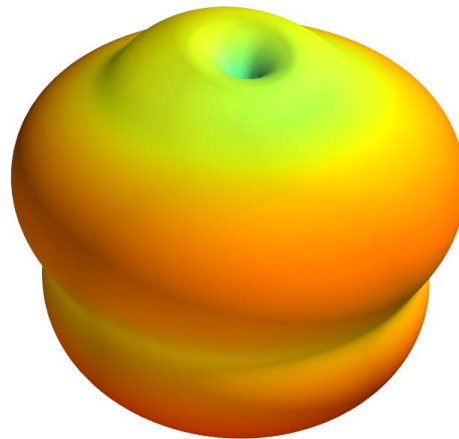

XY Plane

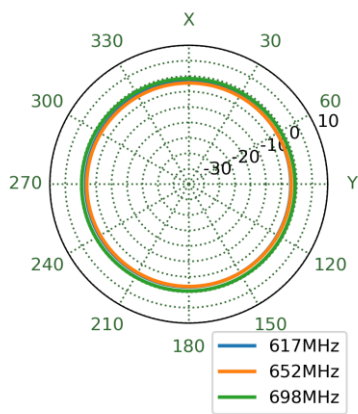

XZ Plane

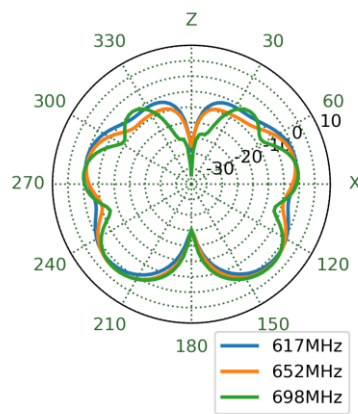

YZ Plane

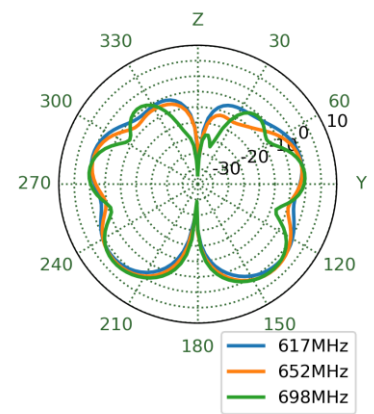

751MHz

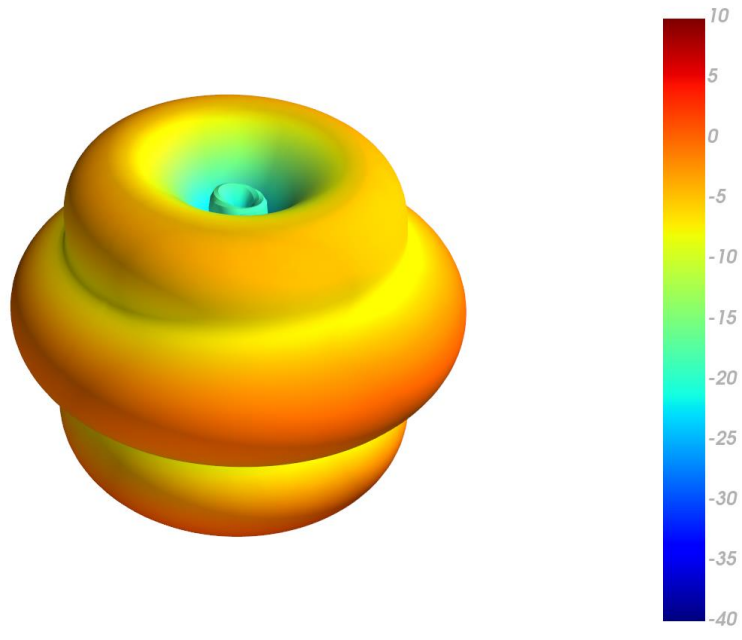

XY Plane      XZ Plane      YZ Plane

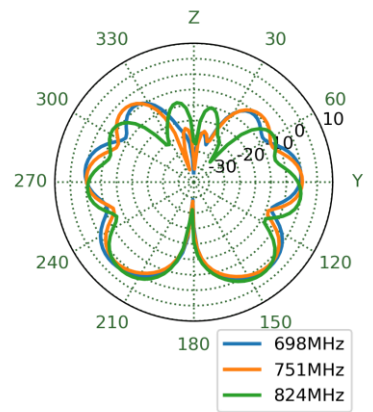
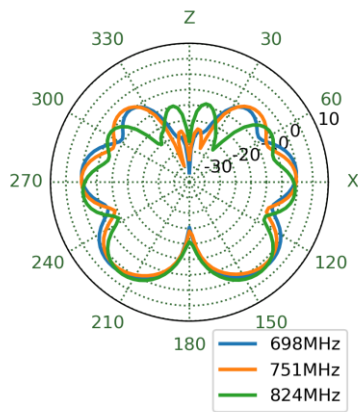
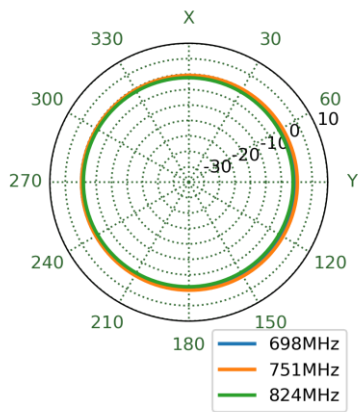

890MHz

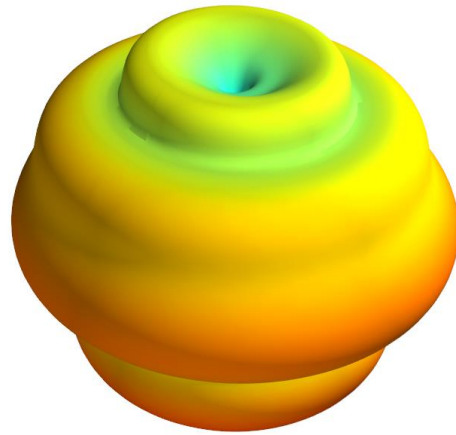

XY Plane      XZ Plane      YZ Plane

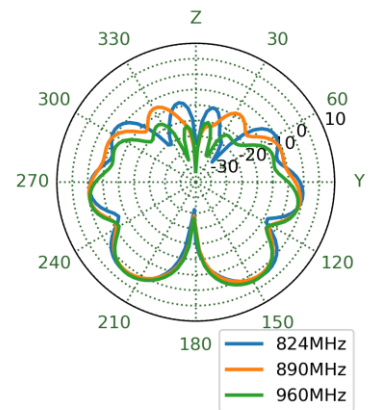
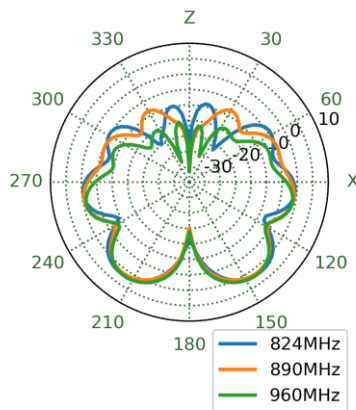
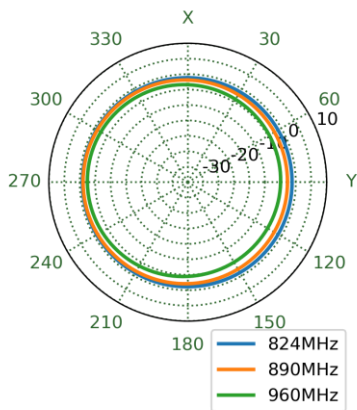

1470MHz

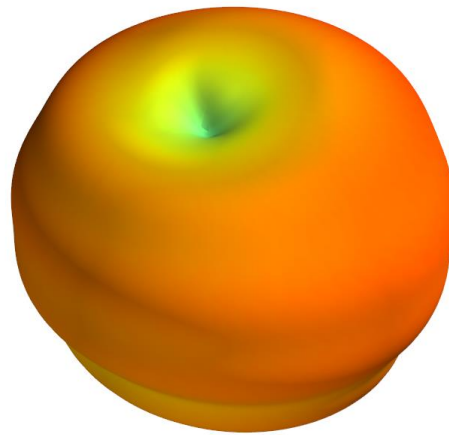

XY Plane      XZ Plane      YZ Plane

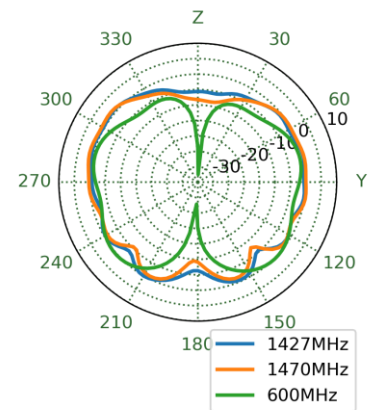
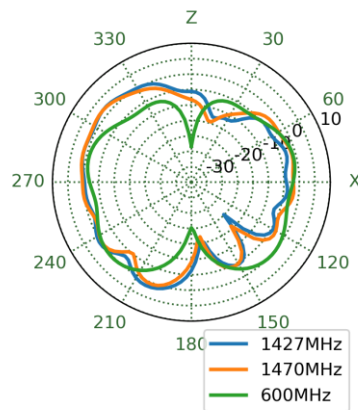
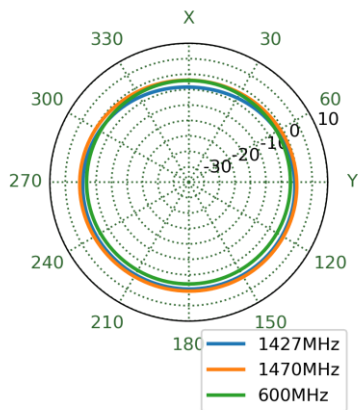

1930MHz

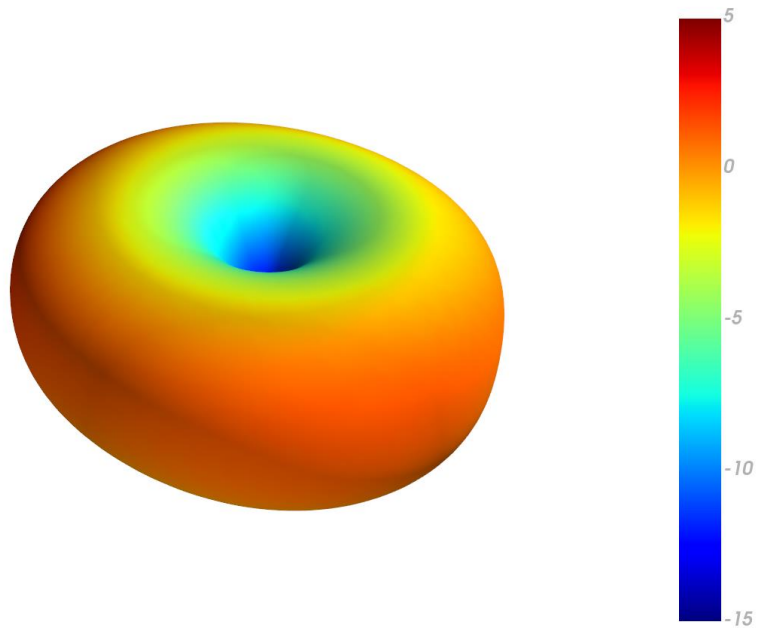

XY Plane      XZ Plane      YZ Plane

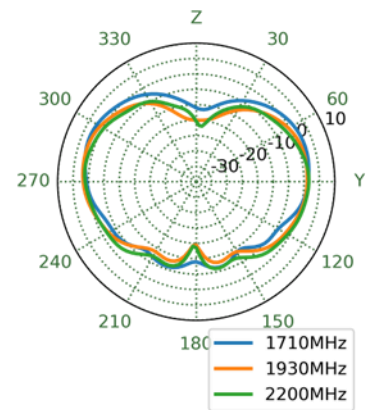
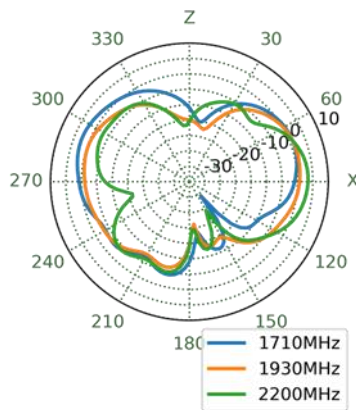
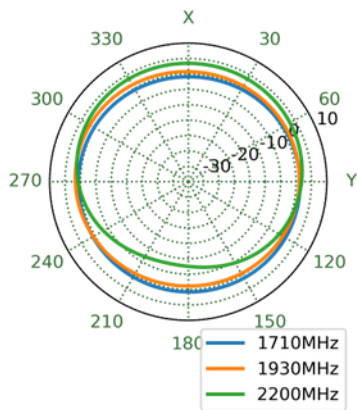

2500MHz

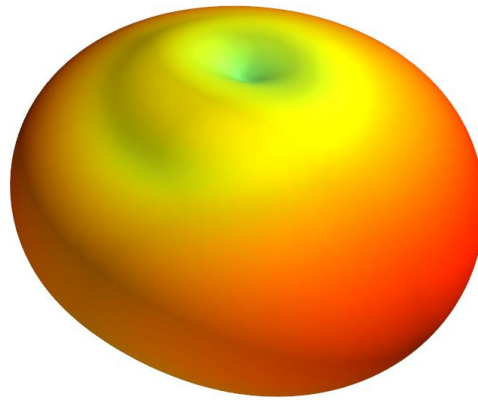

XY Plane      XZ Plane      YZ Plane

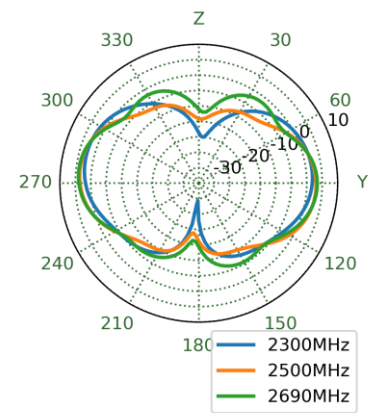
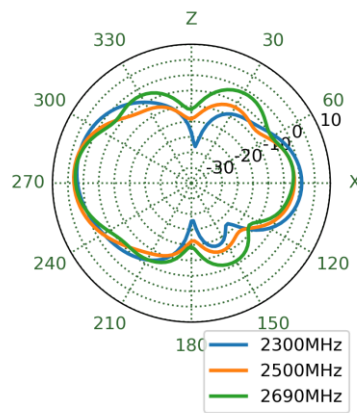
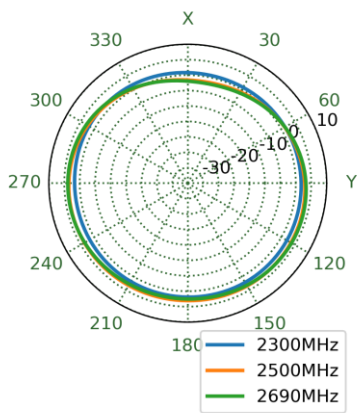

3550MHz

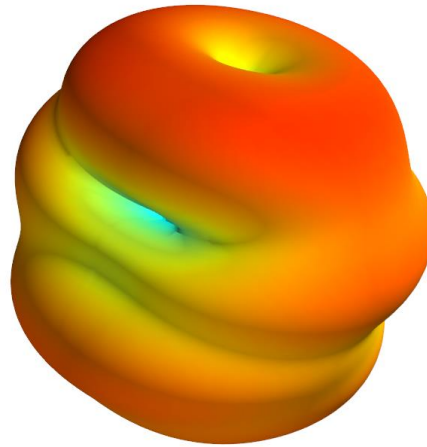

XY Plane      XZ Plane      YZ Plane

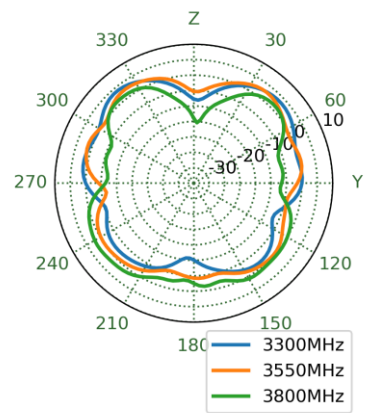
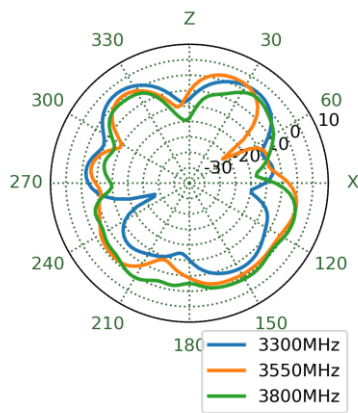
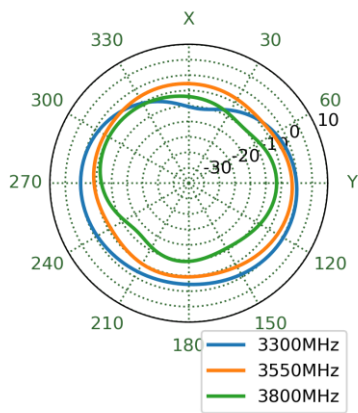

3550MHz

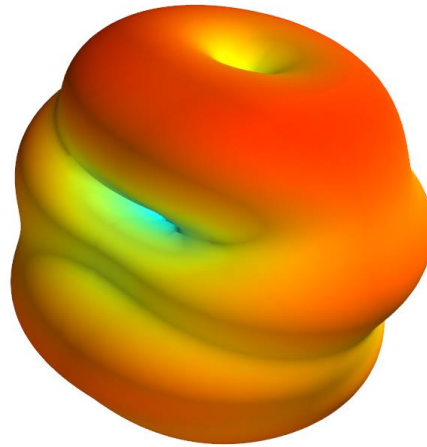

XY Plane

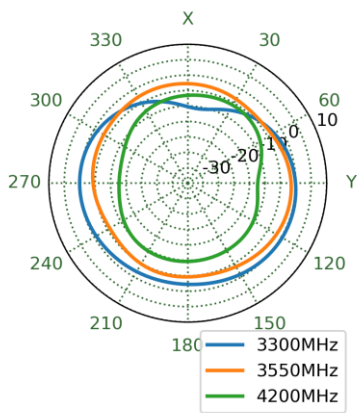

XZ Plane

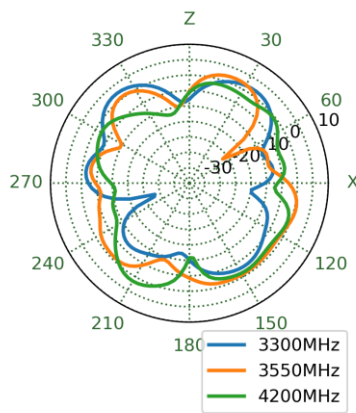

YZ Plane

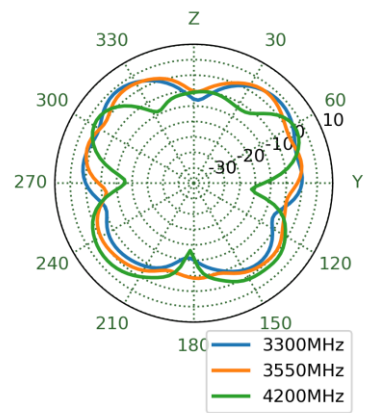

4800MHz

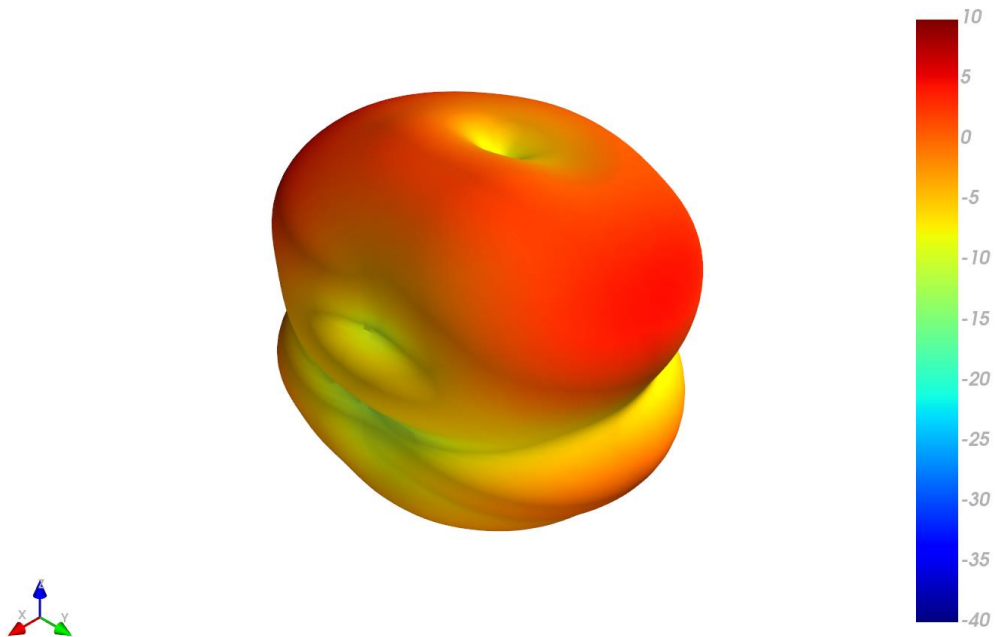

XY Plane

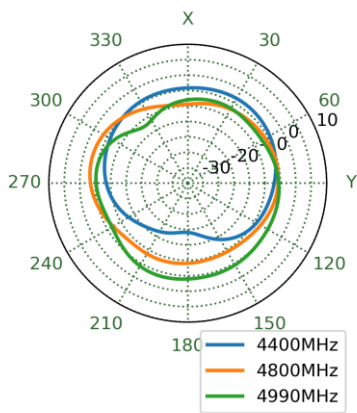

XZ Plane

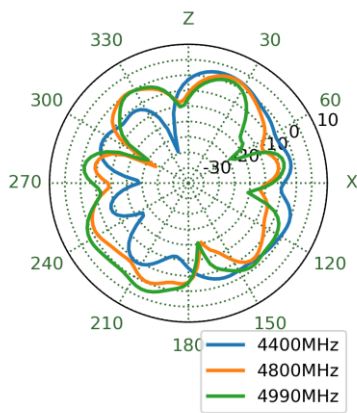

YZ Plane

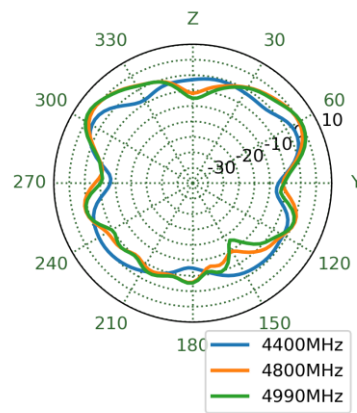

5490MHz

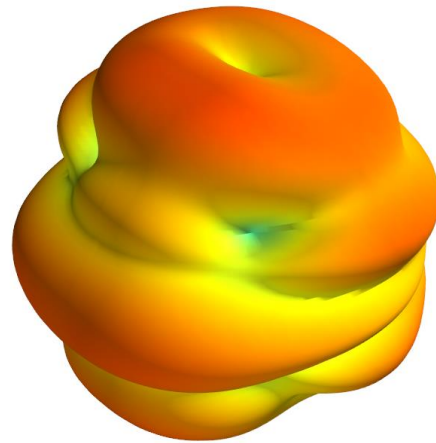

XY Plane      XZ Plane      YZ Plane

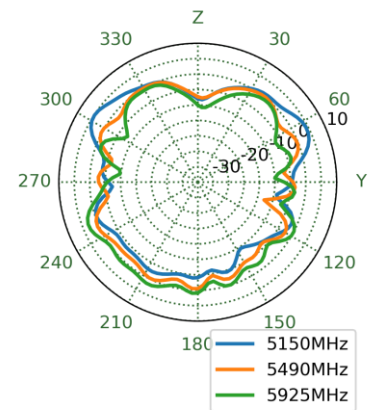
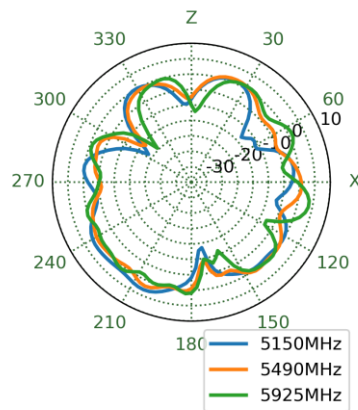
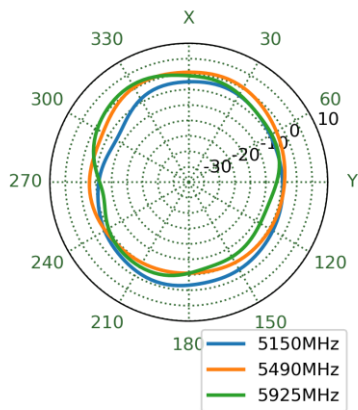

## 5. Mechanical Drawing (Units: mm)

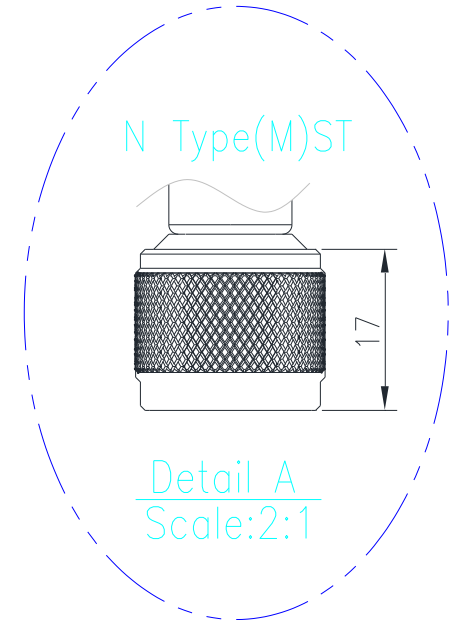
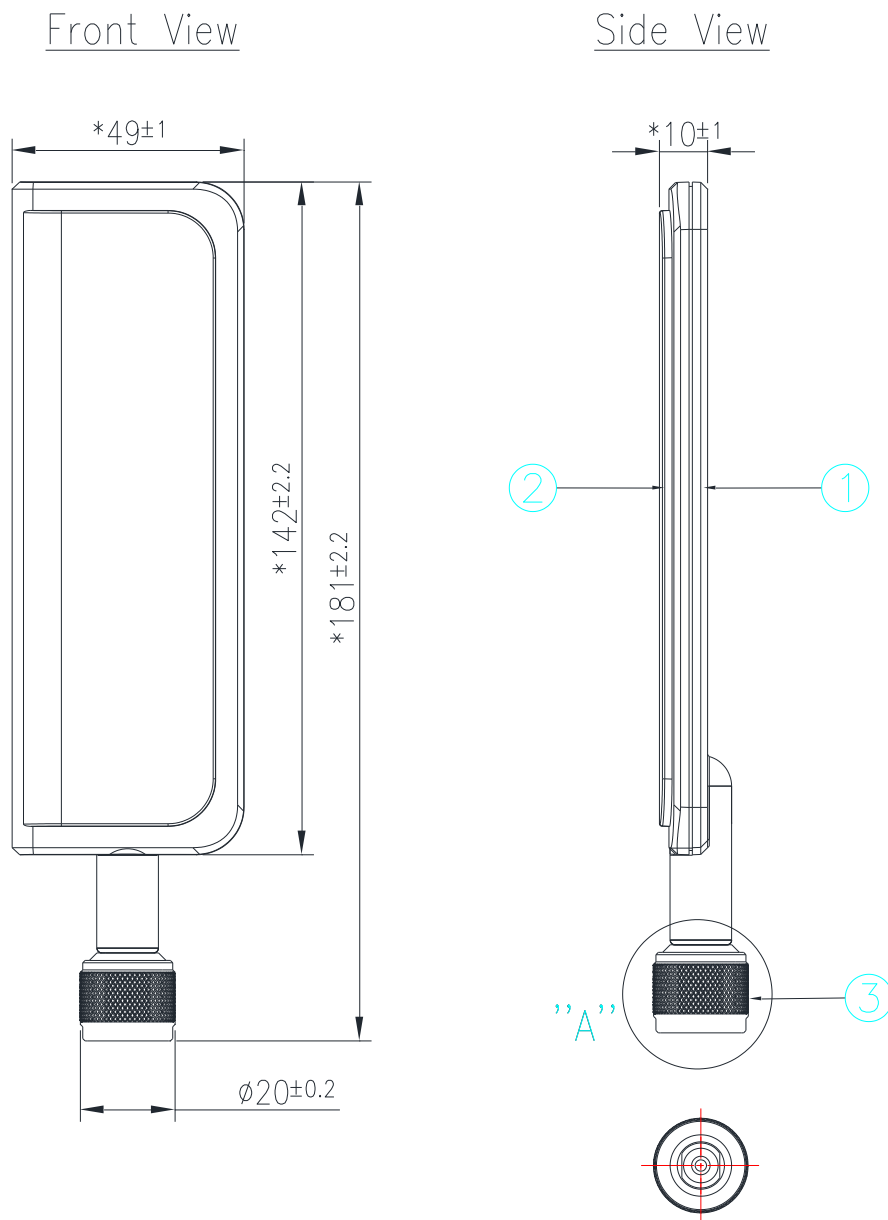

	Name	Material	Finish	QTY
1	Housing_Bottom_ST_W	PC/ABS	White	1
2	Housing_Top_W	PC/ABS	White	1
3	N Type(M)ST	Brass	Ni Plated	1

## 8. Packaging

1pc TG.33.8H11W per PE Bag



50pcs TG.33.8H11W per Large PE Bag

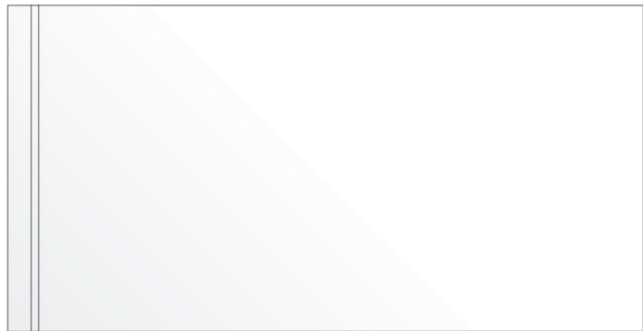

250pcs TG.33.8H11W per Carton  
Dimensions: 430\*380\*280mm

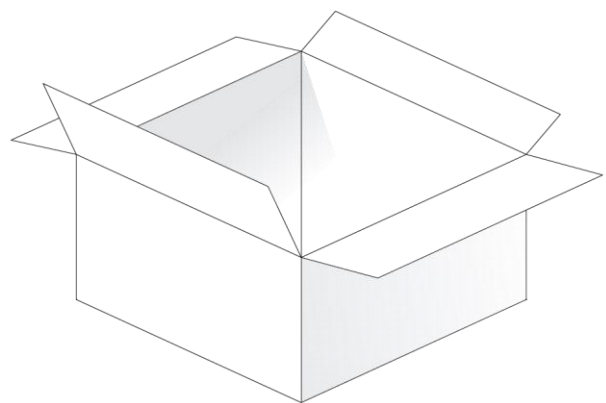

Changelog for the datasheet

**SPE-23-8-243– TG.33.8H11W**

**Revision: A (Original First Release)**

Date:	2023-08-30
Notes:	
Author:	Cesar Sousa

**Previous Revisions**



[www.taoglas.com](http://www.taoglas.com)

