



TAOGLAS®



Datasheet

Blade

Part No:
TD.66.6H31

Description:

5G/4G 600-6000MHz Connector Mount Antenna
With N-Type Male Connector

Features:

600-6000MHz Wideband 5G/4G Cellular Antenna
Fantastic Efficiency Across all Bands
Robust External Antenna for exterior mounting
IP67 Rated Waterproof, suitable for outdoor applications
Omnidirectional Gain Patterns for Optimum Coverage
Connector: N-Type Male
Dimensions: 228 * Ø22.8 mm
RoHS and REACH Compliant

1. Introduction	3
2. Specifications	4
3. Antenna Characteristics	6
4. Radiation Patterns	9
5. Mechanical Drawing	20
6. Packaging	21
<hr/>	
Changelog	22

Taoglas makes no warranties based on the accuracy or completeness of the contents of this document and reserves the right to make changes to specifications and product descriptions at any time without notice. Taoglas reserves all rights to this document and the information contained herein. Reproduction, use or disclosure to third parties without express permission is strictly prohibited.



1. Introduction



The Taoglas TD.66 is a robust antenna designed to cover all global 5G/4G frequencies between 600MHz and 6GHz. The TD.66 uses a robust PC/ABS enclosure along with an IP67 rating, which is ideal for outdoor applications. The TD.66 is supplied with an N-Type male connector meaning can be directly installed on gateways and routers which come with N-Type connectors. The TD.66 performs excellently at 5G bands with efficiencies above 50% across the entire 5G/4G spectrum while also maintaining stable radiation patterns.

The Blade TD.66 has been evolved from the highly successful TD.95 and is part of the ever-growing portfolio of 5G antennas offered by Taoglas.

Typical Applications include:

- Gateways and Routers
- Cameras and Security
- Public Safety
- Point of Sales Terminals
- Smart Home Automation
- Robotics / Autonomous

The TD.66 comes with a N-Type Male connector as standard and this can be customized subject to MOQ and NRE, contact your regional Taoglas customer support team for more information.

2. Specifications

Electrical

Band	Frequency (MHz)	Efficiency (%)	Average Gain (dB)	Peak Gain (dBi)	Impedance	Max Input Power	Polarization	Radiation Pattern
5GNR/4G Band 71	617~698	78	-1.04	1.8	50 Ω	10W	Linear	Omni-Directional
4G/3G Band 12,13,14,17,28,29	698~824	51	-2.9	1.6				
4G/3G/NB-IoT/Cat M Band 5,8,18,19,20,26,27	824~960	49	-3.09	2.6				
5GNR/4G Band 21,32,74,75,76	1427~1518	79	-1.04	3.9				
4G/3G Band 1,2,3,4,9,23,25,35,39,66	1710~2200	70	-1.54	2.5				
4G/3G Band 7,30,38,40,41	2300~2690	57	-2.41	3.9				
5GNR/4G Band 22,42,48,77,78,79	3300~5000	75	-1.21	4.4				
LTE5200/ Wi-Fi 5800	5150~5925	66	-1.79	5.4				

*Tested in free space

Mechanical

Dimensions	229 x 23 mm
Weight	70g
Plastic Material	PC/ABS
Connector	N-Type Male

Environmental

Temperature Range	-40°C to 85°C
-------------------	---------------

5G/4G Bands			
Band Number	5G NR / FR1 / LTE / LTE-Advanced / WCDMA / HSPA / HSPA+ / TD-SCDMA		
	Uplink	Downlink	Covered
1	UL: 1920 to 1980	DL: 2110 to 2170	✓
2	UL: 1850 to 1910	DL: 1930 to 1990	✓
3	UL: 1710 to 1785	DL: 1805 to 1880	✓
4	UL: 1710 to 1755	DL: 2110 to 2155	✓
5	UL: 824 to 849	DL: 869 to 894	✓
7	UL: 2500 to 2570	DL: 2620 to 2690	✓
8	UL: 880 to 915	DL: 925 to 960	✓
9	UL: 1749.9 to 1784.9	DL: 1844.9 to 1879.9	✓
11	UL: 1427.9 to 1447.9	DL: 1475.9 to 1495.9	✓
12	UL: 699 to 716	DL: 729 to 746	✓
13	UL: 777 to 787	DL: 746 to 756	✓
14	UL: 788 to 798	DL: 758 to 768	✓
17	UL: 704 to 716	DL: 734 to 746	✓
18	UL: 815 to 830	DL: 860 to 875	✓
19	UL: 830 to 845	DL: 875 to 890	✓
20	UL: 832 to 862	DL: 791 to 821	✓
21	UL: 1447.9 to 1462.9	DL: 1495.9 to 1510.9	✓
22	UL: 3410 to 3490	DL: 3510 to 3590	✓
23	UL: 2000 to 2020	DL: 2180 to 2200	✓
24	UL: 1625.5 to 1660.5	DL: 1525 to 1559	✓
25	UL: 1850 to 1915	DL: 1930 to 1995	✓
26	UL: 814 to 849	DL: 859 to 894	✓
27	UL: 807 to 824	DL: 852 to 869	✓
28	UL: 703 to 748	DL: 758 to 803	✓
29	UL: -	DL: 717 to 728	✓
30	UL: 2305 to 2315	DL: 2350 to 2360	✓
31	UL: 452.5 to 457.5	DL: 462.5 to 467.5	✗
32	UL: -	DL: 1452 - 1496	✓
35		1850 to 1910	✓
38		2570 to 2620	✓
39		1880 to 1920	✓
40		2300 to 2400	✓
41		2496 to 2690	✓
42		3400 to 3600	✓
43		3600 to 3800	✓
48		3550 to 3700	✓
66	UL: 1710-1780	DL: 2110-2200	✓
71		617 to 698	✓
74/75/76		1427 to 1518	✓
77		3300 to 4200	✓
78		3300 to 3800	✓
79		4400 to 5000	✓

3. Antenna Characteristics

3.1 Return Loss

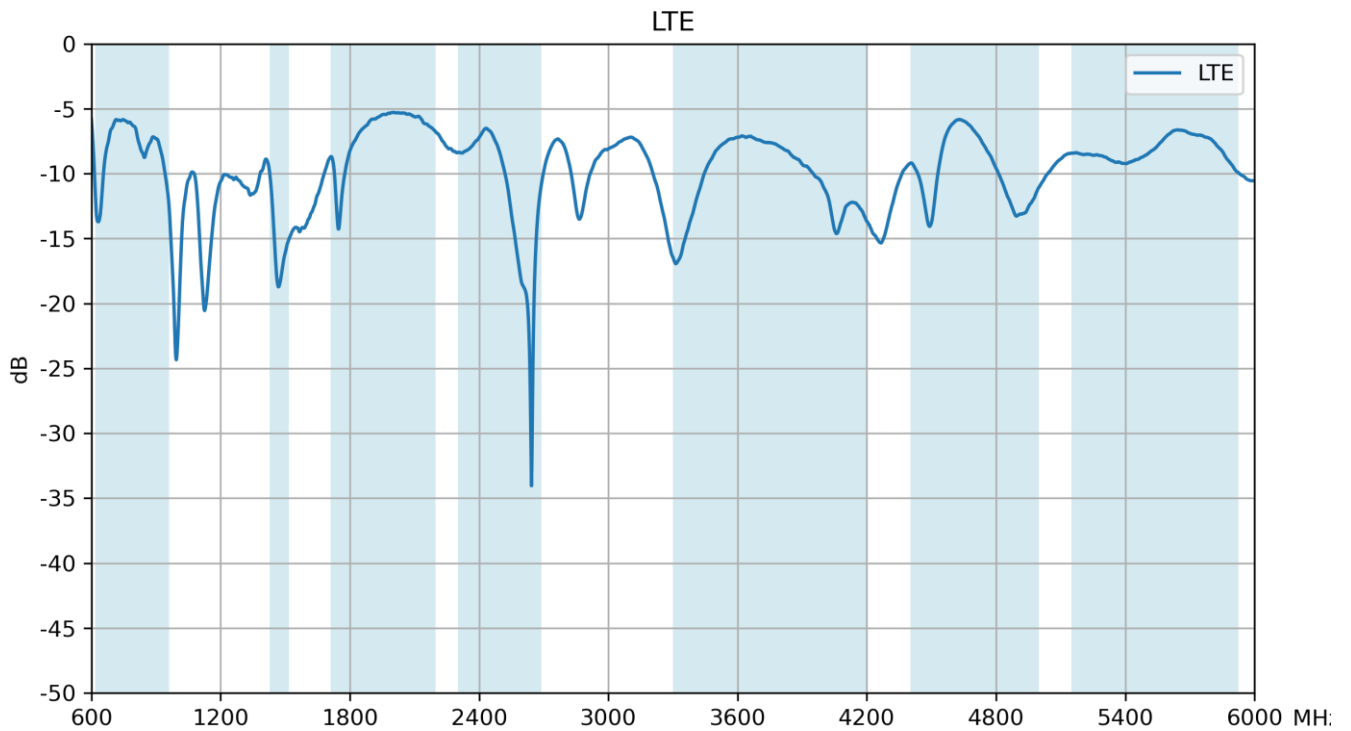

3.2 VSWR

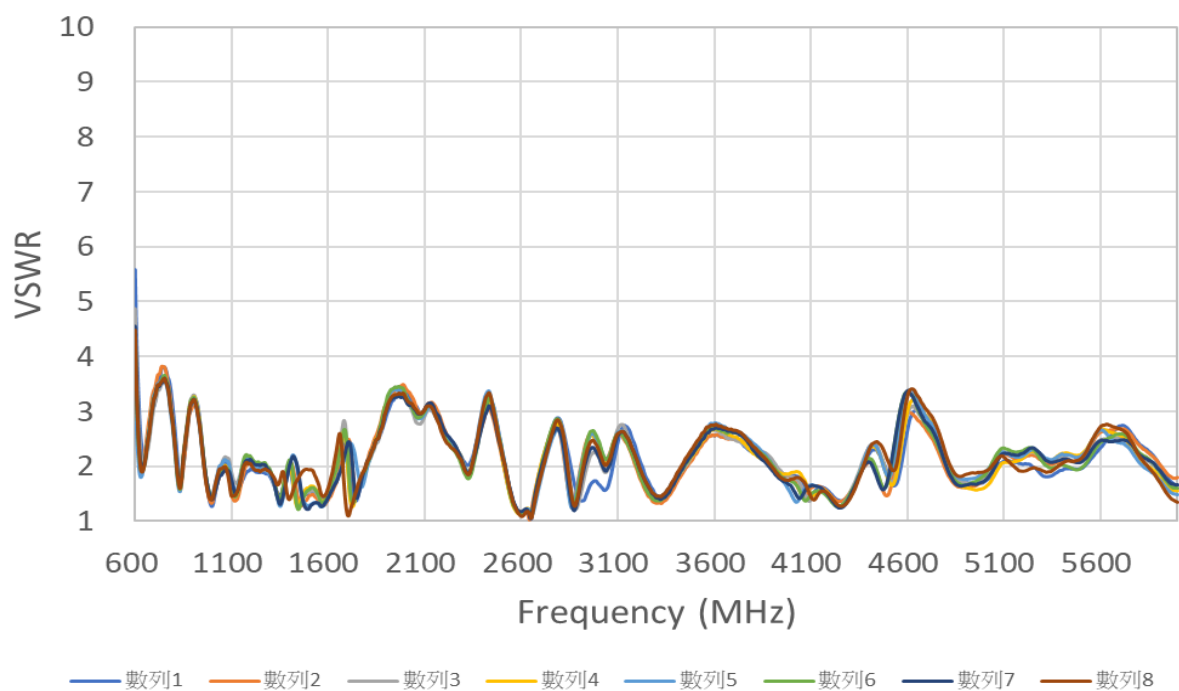

3.3 Efficiency

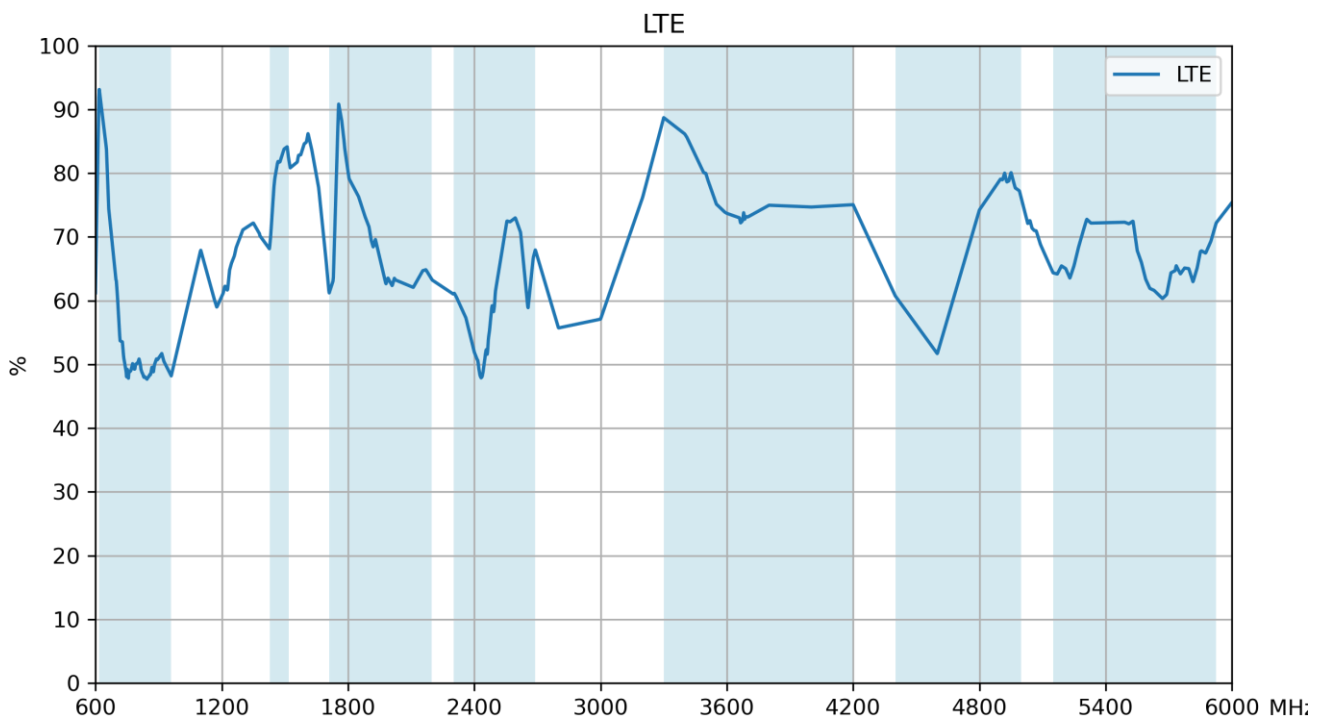

3.4 Peak Gain

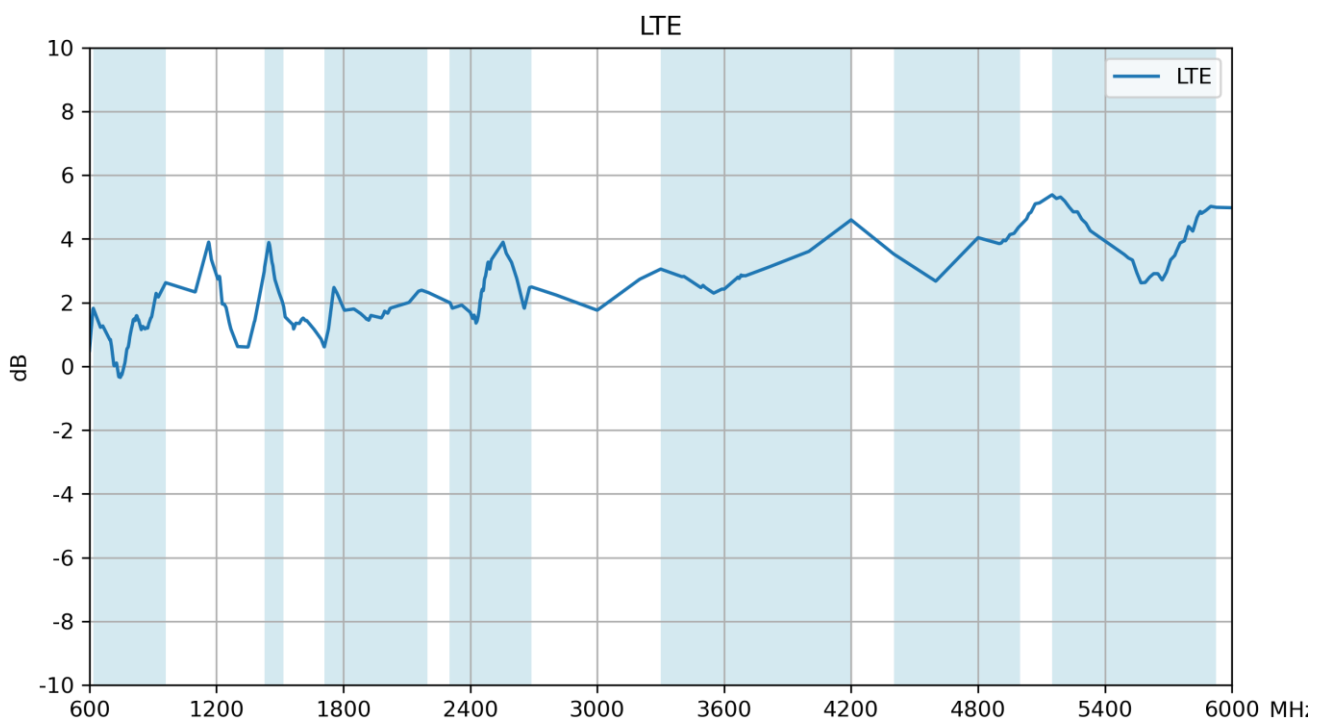

3.5 Average Gain

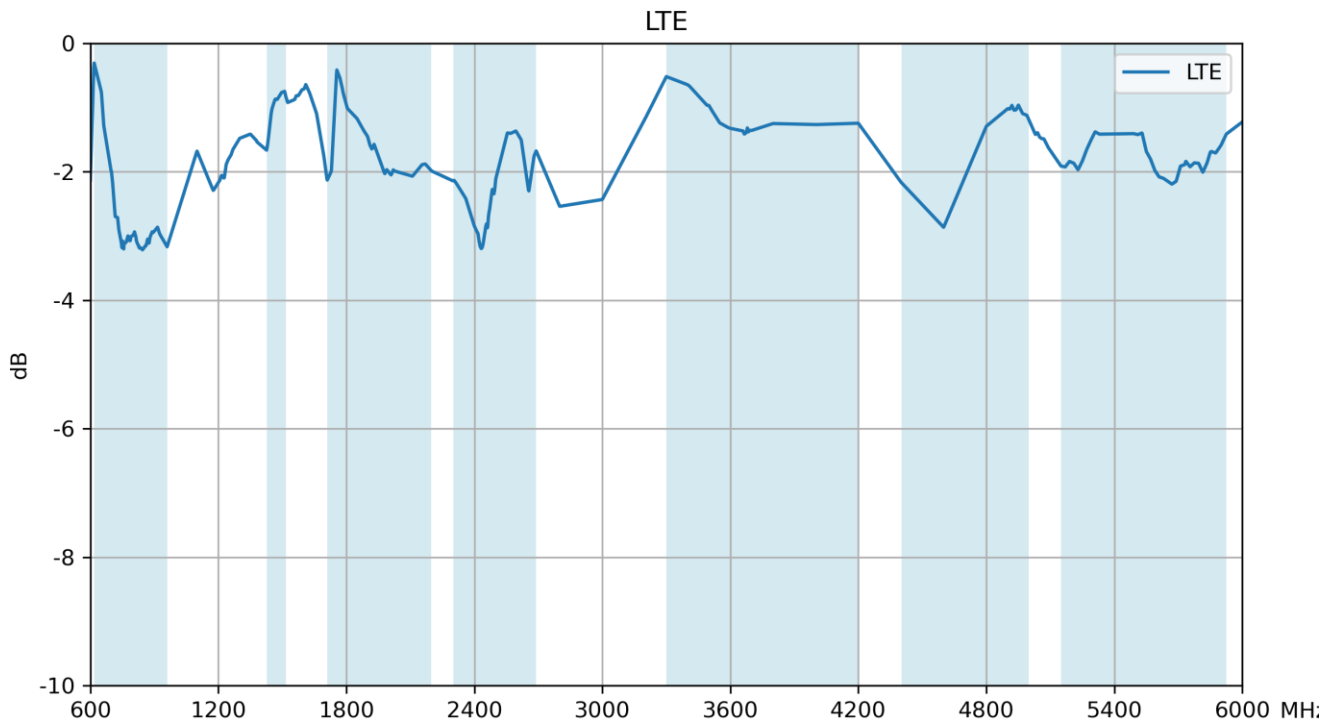

4. Radiation Patterns

4.1 Test Setup

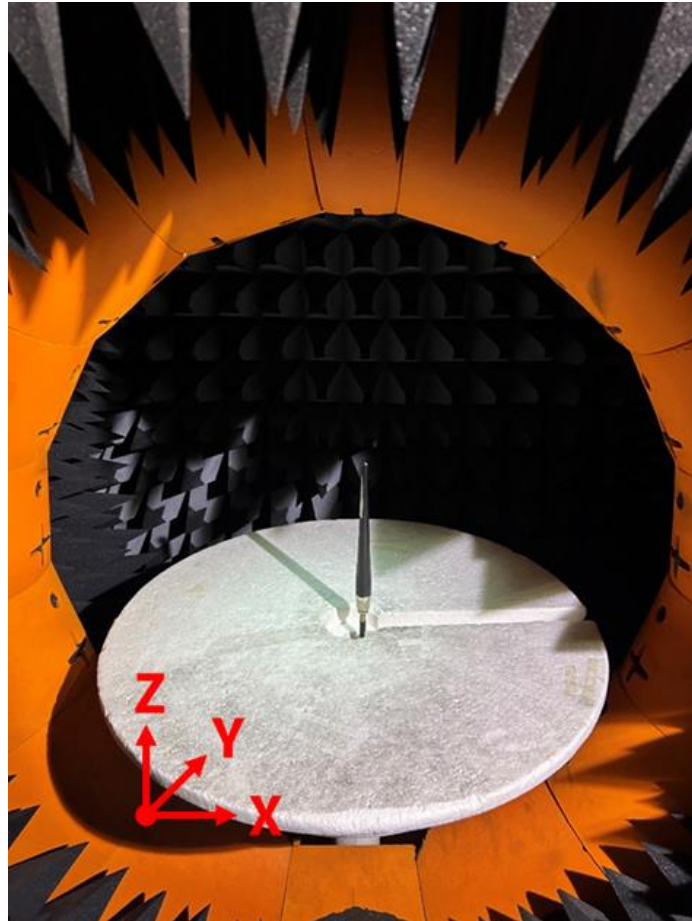

4.2 3D and 2D Radiation Patterns – Straight

663MHz

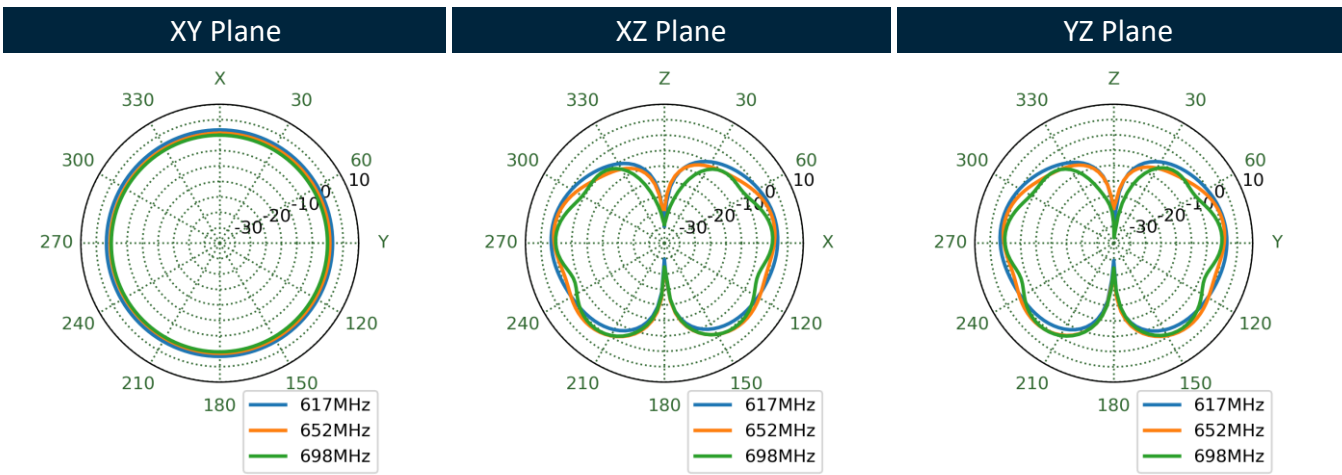
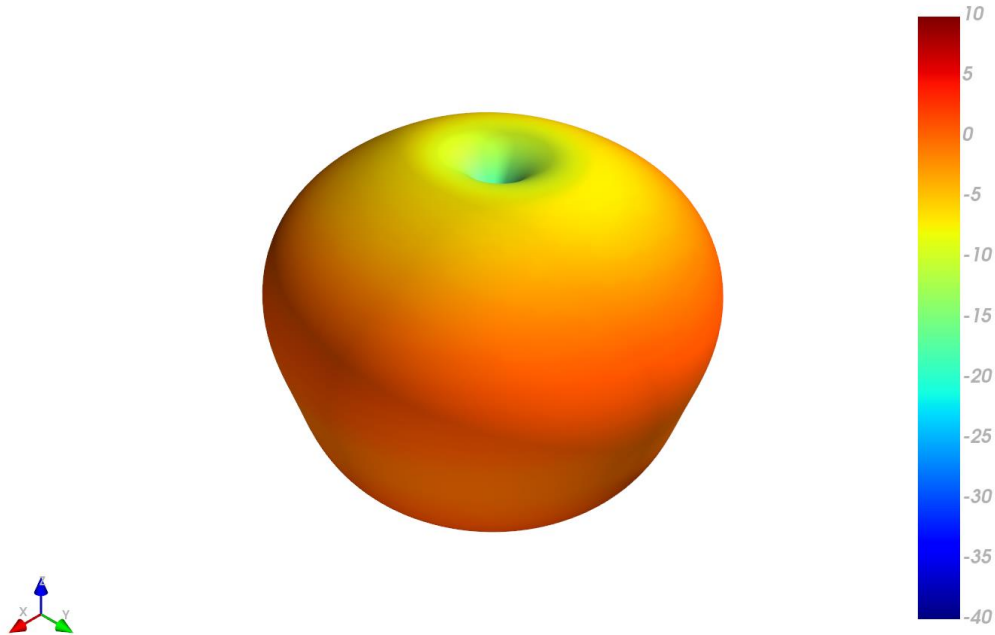

751MHz

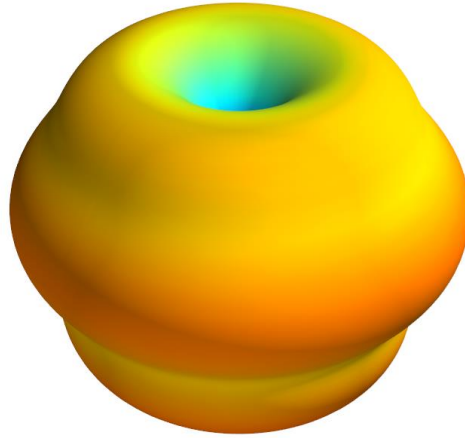

XY Plane

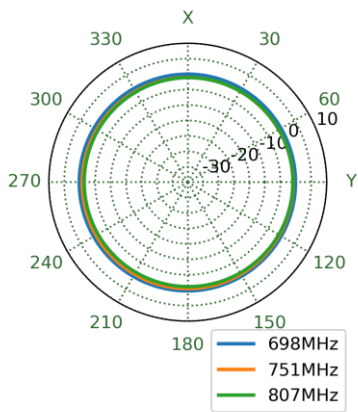

XZ Plane

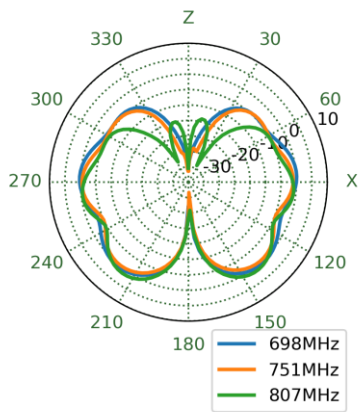

YZ Plane

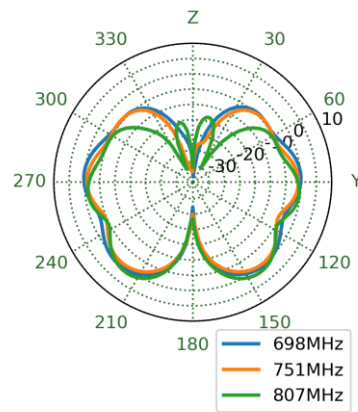

890MHz

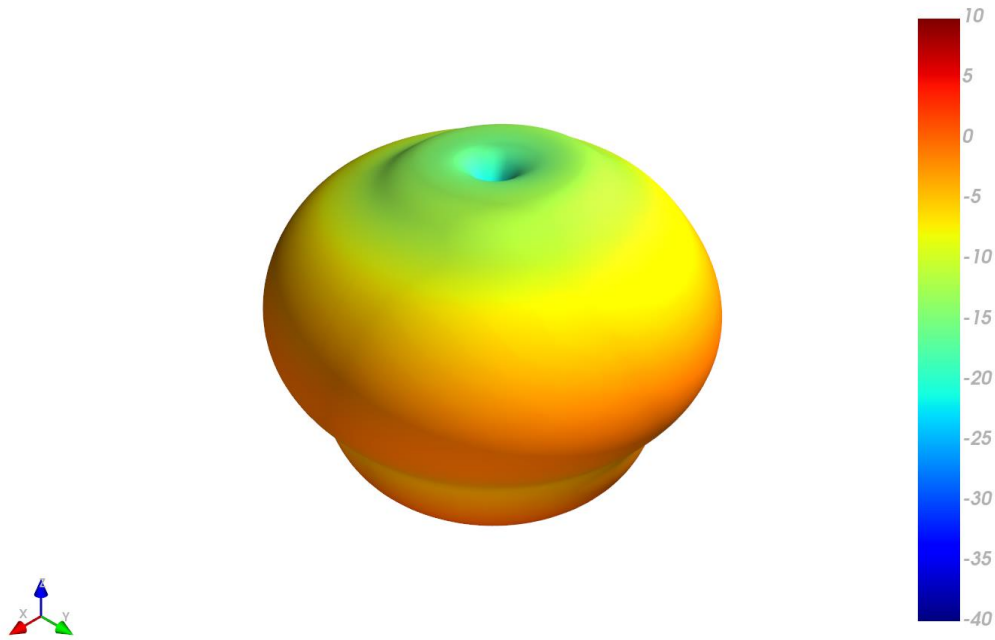

XY Plane

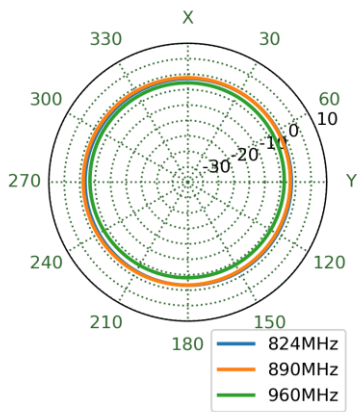

XZ Plane

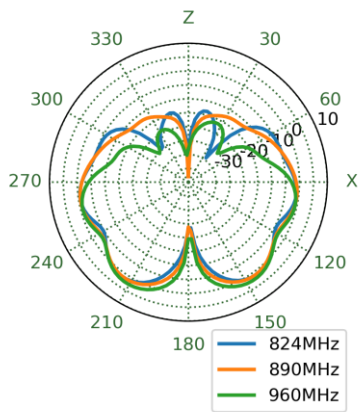

YZ Plane

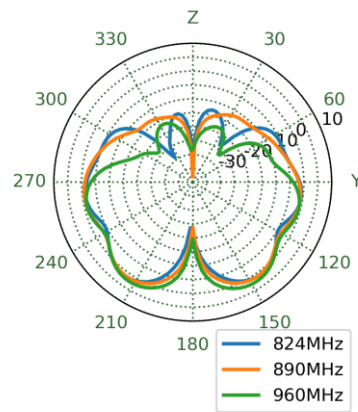

1470MHz

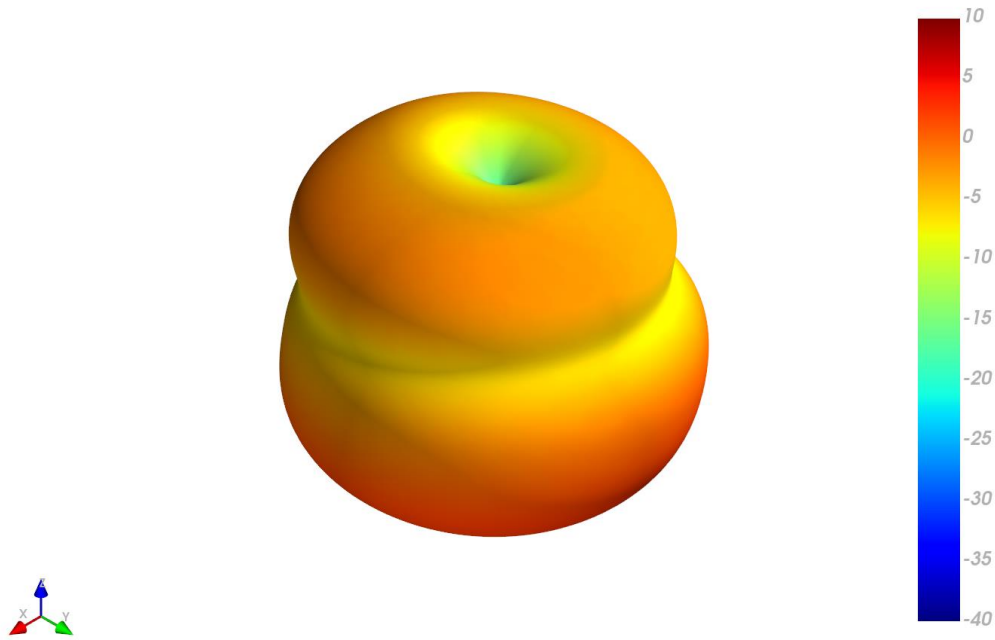

XY Plane

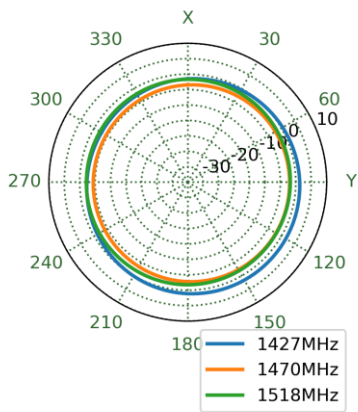

XZ Plane

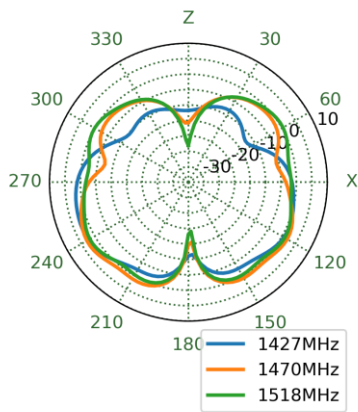

YZ Plane

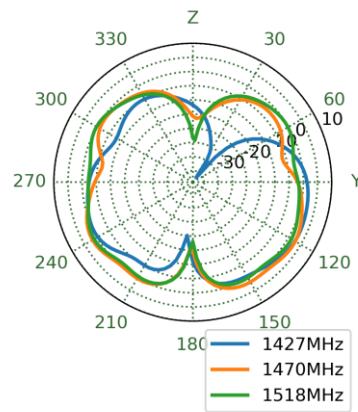

1805MHz

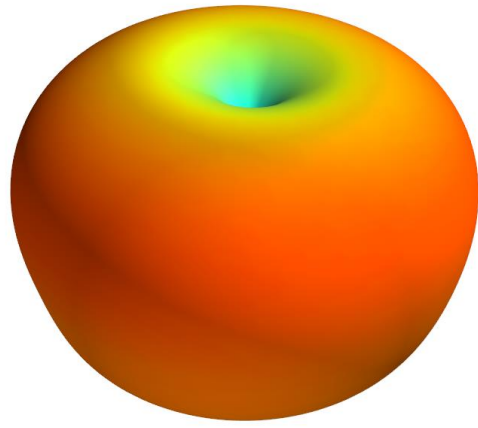

XY Plane

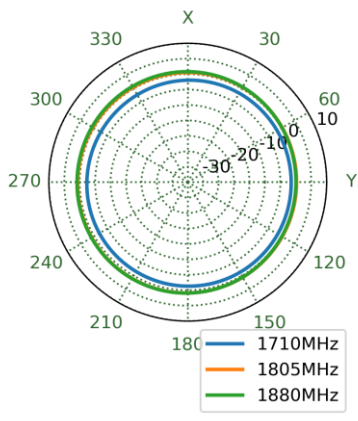

XZ Plane

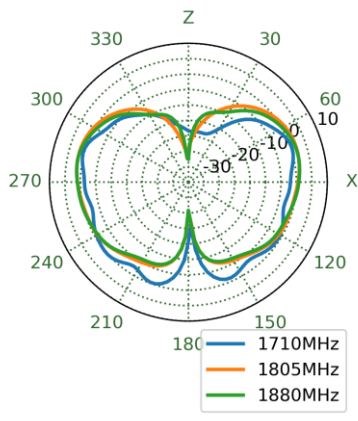

YZ Plane

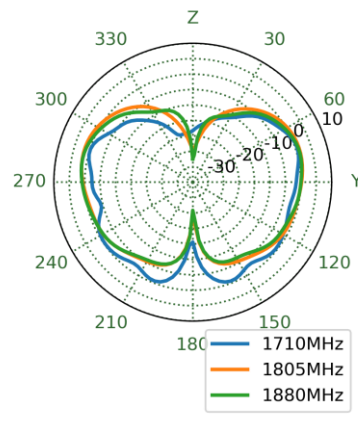

1920MHz

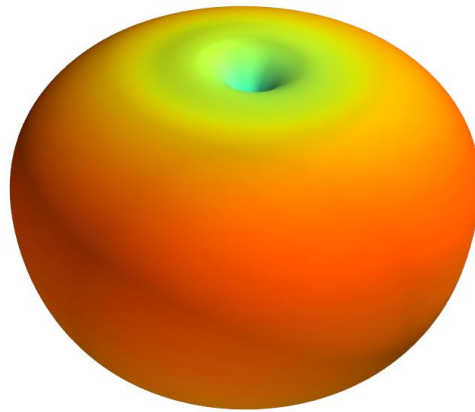

XY Plane

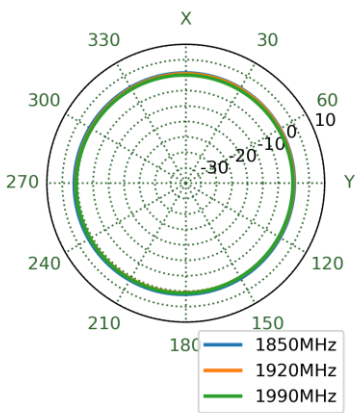

XZ Plane

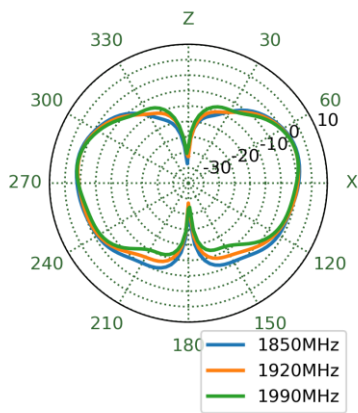

YZ Plane

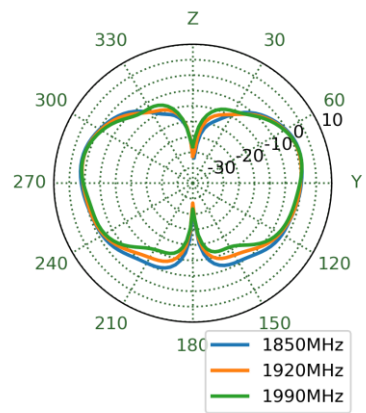

1990MHz

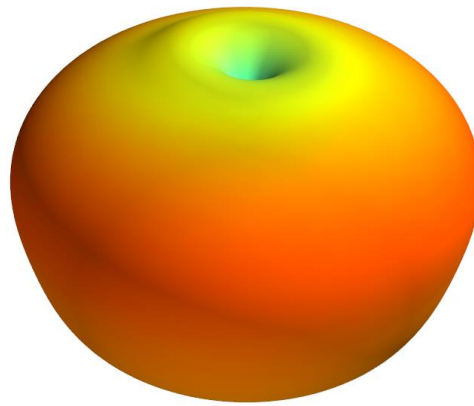

XY Plane

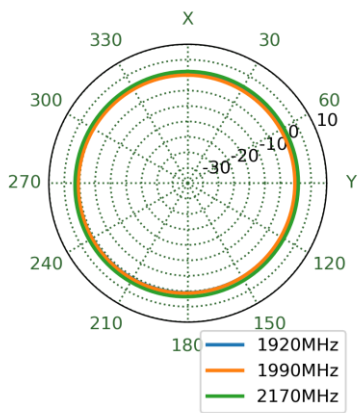

XZ Plane

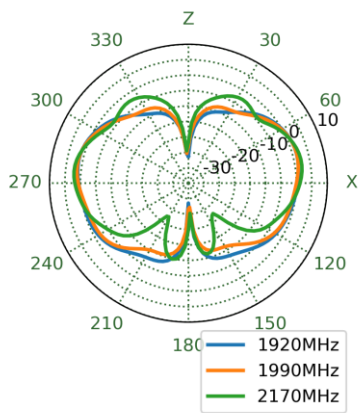

YZ Plane

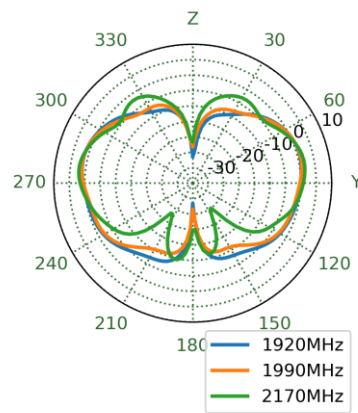

2595MHz

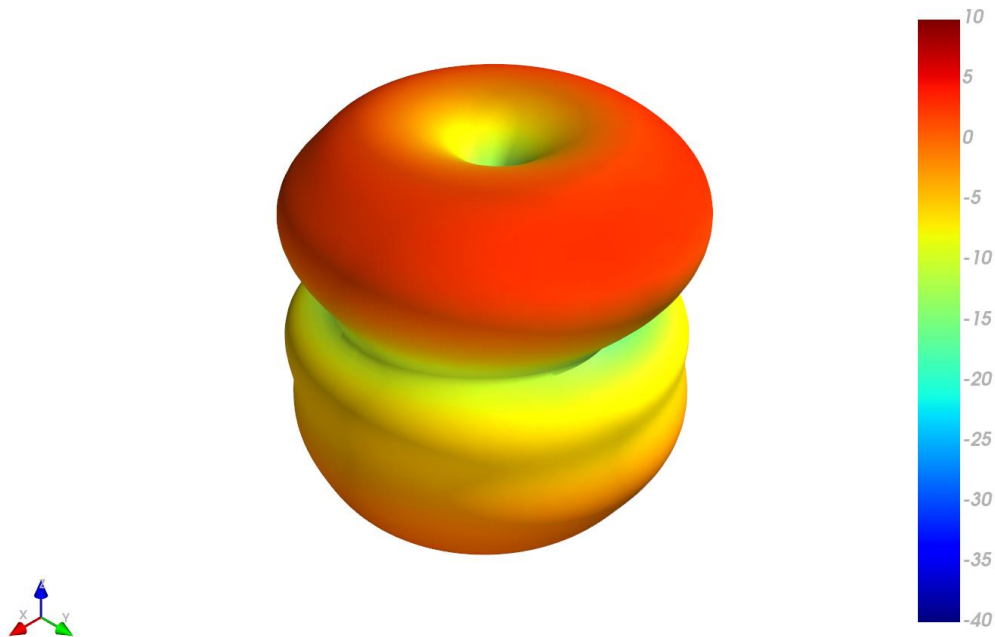

XY Plane

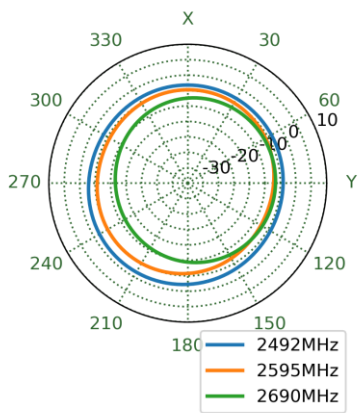

XZ Plane

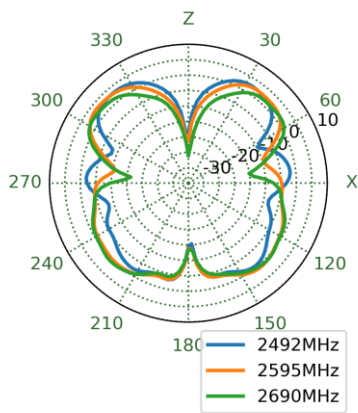

YZ Plane

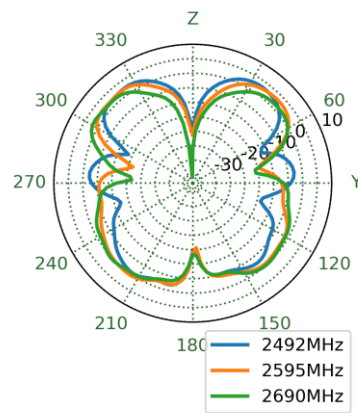

3550MHz

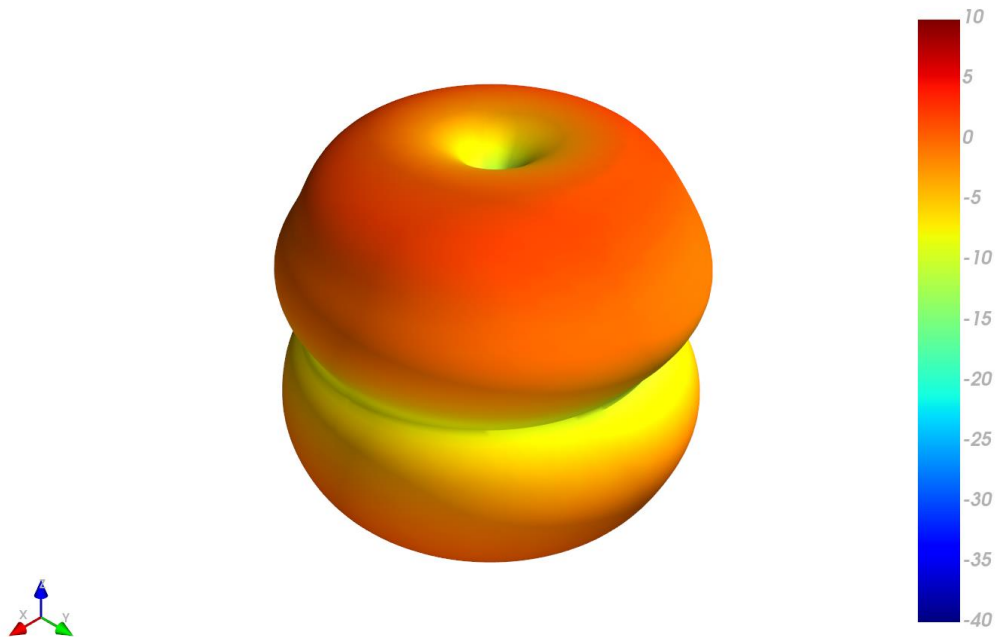

XY Plane

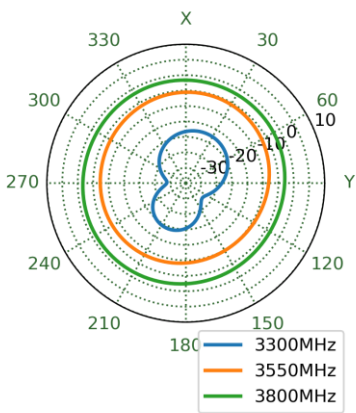

XZ Plane

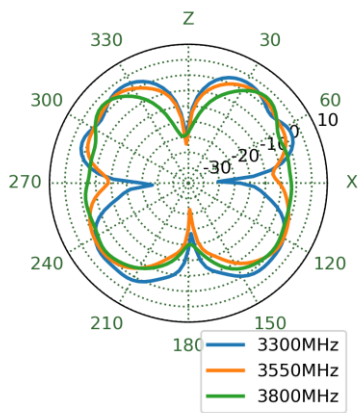

YZ Plane

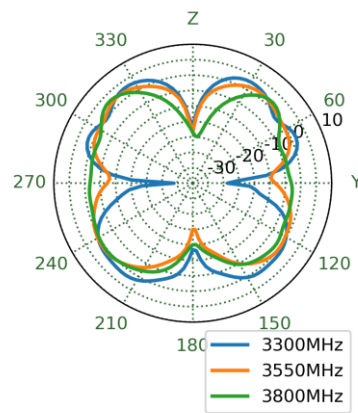

4800MHz

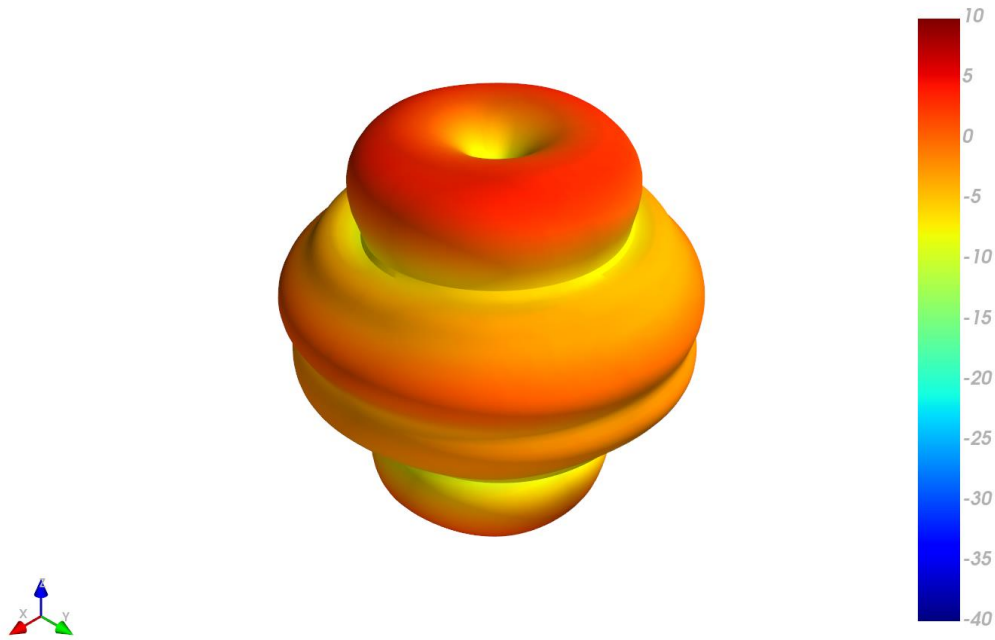

XY Plane

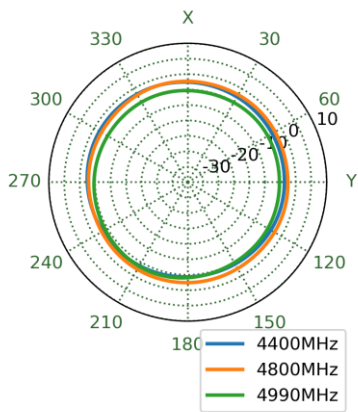

XZ Plane

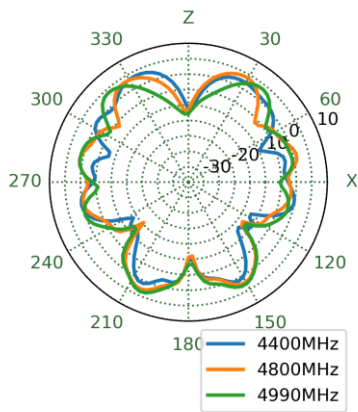

YZ Plane

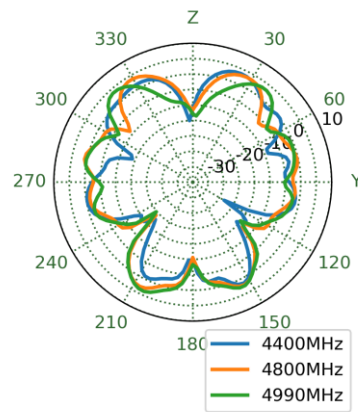

5530MHz

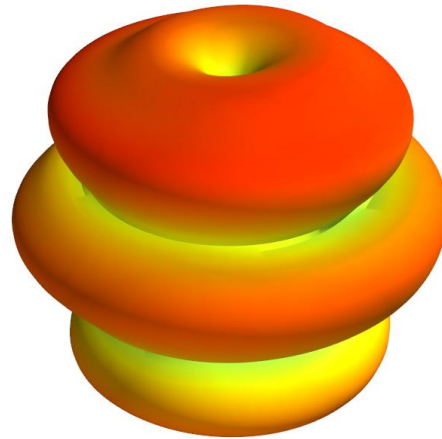

XY Plane

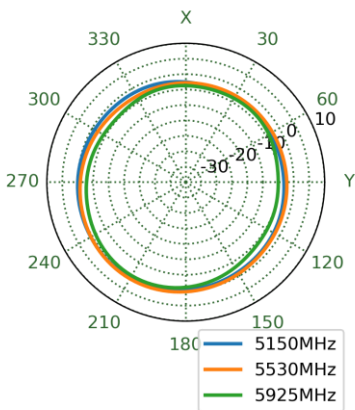

XZ Plane

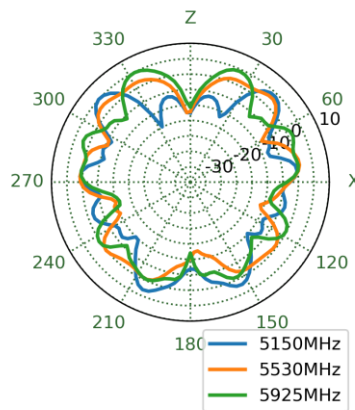

YZ Plane

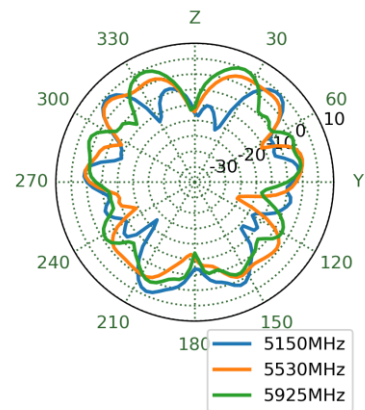

5. Mechanical Drawing (Units: mm)

ISO NO.: EDW-23-8-0680

STATE: Release

NOTES: 1. All material must be RoHS compliant.

REV.	DESCRIPTION	ENG.	APPROVED	DATE
01	Initial Design	Karry	Aaron	2023/05/24

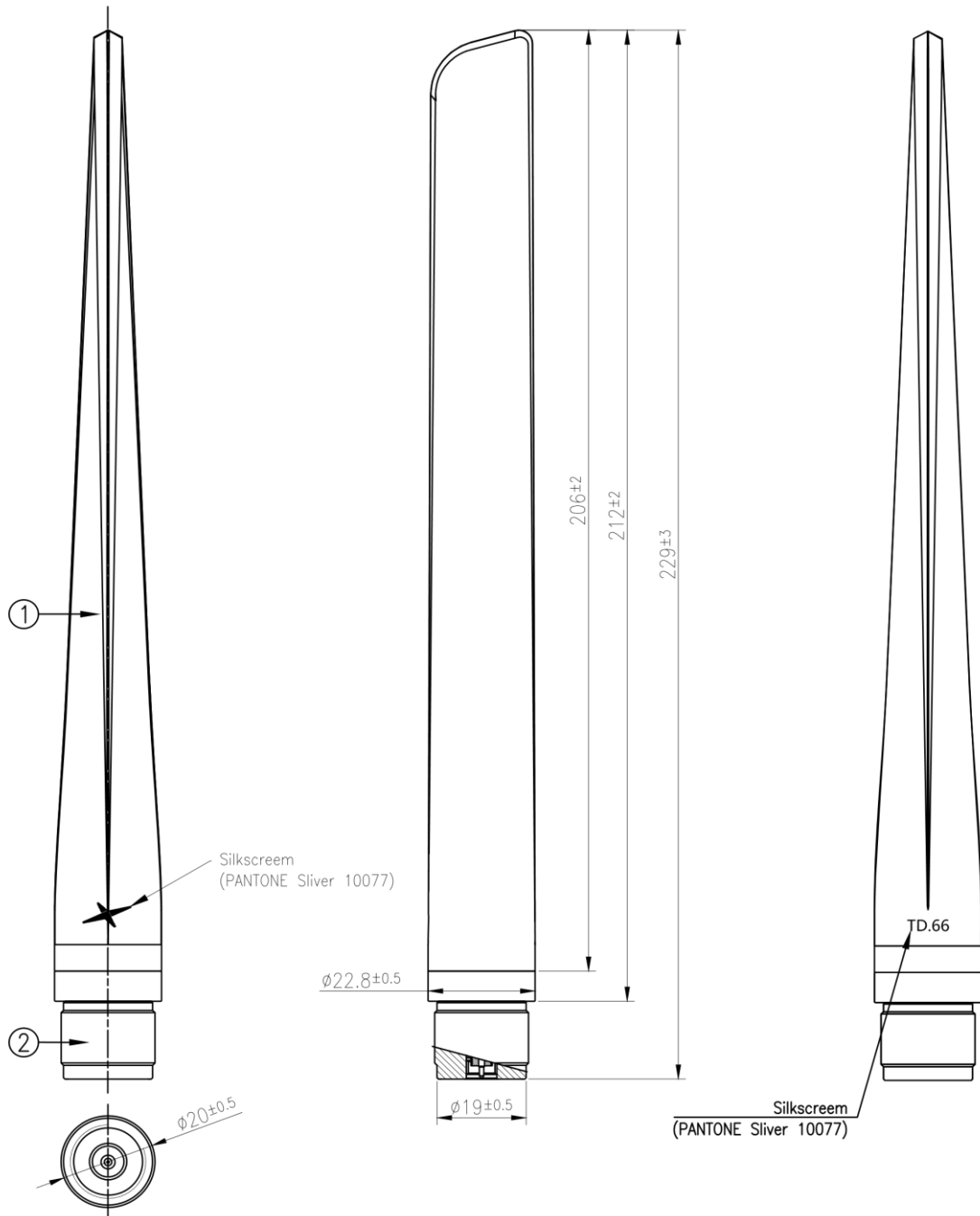

	Name	Material	Finish	QTY
1	Housing	PC/ABS AC200	Black	1
2	N Type (M) Connector	Brass	Ni Plated	1

APPROVED BY: Aaron	<p>TW Design Centre This drawing and its inherent design concepts are property of Taoglas. Not to be copied or given to third parties without the written consent of Taoglas.</p>
CHECK BY: Aaron	
DRAWN BY: Karry	
DATE: 2023/05/24	
UNLESS OTHERWISE SPECIFIED TOLERANCES ON:	<p>TITLE : Blade Wideband 600-6000MHz 5G/4G Connector Mount Antenna - N-Type Male</p> <p>PART NO. : TD.66.AH31</p>
THIRD ANGLE PROJECTION	<p>UNIT: mm SCALE: 1:1.25 PAGES: 1/1 REV. D01</p>

8. Packaging

1pc TD.66.6H31 per PE Bag
 Bag Dimension: 200*100mm
 Weight: 70g

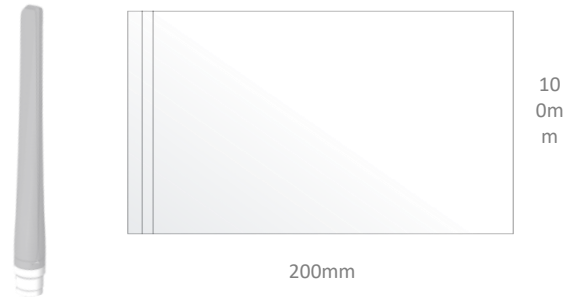

20pcs TD.66.6H31 per Large PE Bag
 Bag Dimensions: 180*265mm
 Weight: 1.4Kg

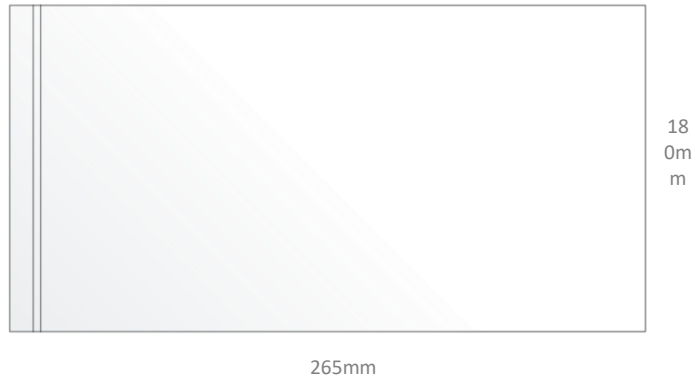

200pcs TD.66.6H31 per Carton
 Dimensions: 320*250*230mm
 Weight: 14Kg

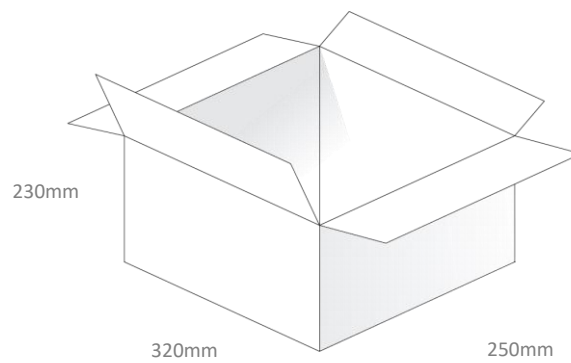

Changelog for the datasheet

SPE-23-8-234 – TG.66.A113

Revision: A (Original First Release)	
Date:	2021-07-07
Notes:	
Author:	Jack Conroy

Previous Revisions



www.taoglas.com

