



TAOGLAS®



Datasheet

Part No:
PCS.55.A

Description

Small OTS LTE Antenna 600-3000 MHz

Features:

Small form factor

SMD Dielectric Antenna

5G/4G/LTE: 600-3000MHz

GPS / GLONASS / Galileo / BeiDou (1561-1602MHz)

Available in North America (NA), European Union (EMEA), and World Wide (WW) configurations

Dimensions: 27*10*1.6mm

RoHS & REACH Compliant

1.	Introduction	2
2.	Specifications	3
3.	Antenna Characteristics	6
4.	Radiation Patterns	9
5.	Mechanical Drawing	46
6.	Packaging	47
7.	Antenna Integration Guide	48
8.	Application Note	59
9	Solder Reflow Profile	69
<hr/>		
	Changelog	70

Taoglas makes no warranties based on the accuracy or completeness of the contents of this document and reserves the right to make changes to specifications and product descriptions at any time without notice. Taoglas reserves all rights to this document and the information contained herein. Reproduction, use or disclosure to third parties without express permission is strictly prohibited.



1. Introduction

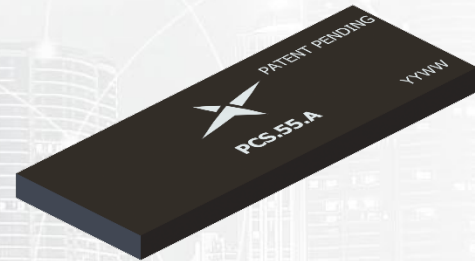

The PCS.55.A, is a patent pending compact cellular antenna designed specifically for IoT devices with small ground planes. It combines revolutionary antenna design techniques with the antenna integration experience of Taoglas to provide a solution for wideband coverage of both 5G/4G LTE and GNSS bands, including the most challenging 600-700MHz bands.

The PCS.55.A provides a simple off-the-shelf solution for LTE, LTE CAT-M, NB-IoT, & GNSS applications. At only 27x10x1.6mm, this compact cellular antenna is the perfect antenna for small IoT devices, where requirements for smaller PCB design are becoming more dependent on the antenna size. This antenna also has a relatively small keep-out area compared to most other compact cellular antennas that are on the market, owing to Taoglas' years of antenna design expertise.

Typical Applications include:

- Handheld IoT Devices
- Handsets and Tablets
- Compact Asset Trackers

The PCS.55.A is available in three matching configurations. The optimum components for North America (NA), European Union (EU), and World Wide (WW) have been determined to allow designers to easily integrate the PCS.55.A to get the best performance for any particular deployment scenario. The PCS.55.A is easy to integrate using standard SMD technologies and the matching circuits for each deployment (NA, EMEA, or WW) have been simplified to a 3 component configuration to allow for greater flexibility on the user side.

Many antennas advertise a small form factor but with the hidden cost of implementing a large PCB ground plane. At Taoglas, we believe that the whole antenna system (antenna + ground plane) needs to be small to meet the evolving demands of the IoT market. As a result, we have performed experimental ground plane studies in order to be fully transparent on the effect of small ground planes on antenna performance. This allows our customers to have full visibility on how our antennas will perform on various different ground plane sizes. The data for these studies is shown in the Application Note on page 59. For further information or, integration and matching guidelines contact your regional Taoglas customer support team.

2. Specifications

Electrical										
Band	Frequency (MHz)	Measurement	Efficiency (%)	Average Gain (dB)	Peak Gain (dBi)	Return Loss (dB)	Impedance	Polarization	Radiation Pattern	Max Input Power
5G NR Band 71	617-698	NA	17.9	-7.5	-4.4	-2.5	50 Ω	Linear	Omni	2W
		EMEA	9.1	-10.4	-7.3	-2.5				
		WW	23.9	-6.2	-3.3	-4.7				
5G NR/4G Band 12,17,28,29,85	698-746	NA	47.4	-3.2	0.2	-8.5				
		EMEA	23.3	-6.3	-2.7	-4.1				
		WW	31.2	-5.1	-1.6	-3.7				
5G NR/4G Band 13,14,20,28	746-800	NA	41.7	-3.8	-0.3	-5.1				
		EMEA	31.1	-5.1	-1.5	-4.4				
		WW	31.7	-5.0	-1.5	-3.3				
5G NR/4G Band 5,18,19,20,26,27	800-880	NA	27.4	-5.6	-2.2	-3.1				
		EMEA	35.6	-4.5	-1.0	-5.0				
		WW	32.6	-4.9	-1.6	-4.1				
5G NR/4G Band 5,8,19,26	880-960	NA	16.1	-7.9	-4.4	-2.6				
		EMEA	26.6	-5.7	-1.8	-5.6				
		WW	23.6	-6.3	-2.6	-4.3				
5G NR/4G Band 74,75,76	1427-1518	NA	32.9	-4.8	0.4	-4.7				
		EMEA	24.8	-6.1	-1.0	-3.1				
		WW	31.9	-5.0	0.4	-5.0				
GNSS	1560-1602	NA	43.3	-3.6	1.2	-5.9				
		EMEA	35.2	-4.5	0.7	-4.7				
		WW	43.3	-3.6	1.6	-6.3				
4G/3G Band 1,2,3,4,25,39,66	1710-2155	NA	46.6	-3.3	3.7	-6.3				
		EMEA	47.4	-3.2	3.3	-6.6				
		WW	43.0	-3.7	3.5	-5.9				
4G/3G Band 7, 38, 41, 69	2500-2690	NA	14.7	-8.3	-2.0	-1.8				
		EMEA	20.9	-6.8	-0.4	-2.2				
		WW	18.6	-7.3	0.0	-2.2				

The PCS.55.A antenna performance was measured with Taoglas PCSD.55.A EVB.

Mechanical

Antenna Dimensions	27 x 10 x 1.6mm
Material	FR4
Weight	0.9g
Soldering Type	SMD

Environmental

Operation Temperature	-40°C ~ +85°C
Storage Temperature	-40°C ~ +85°C
Moisture Sensitivity Level	3

5G/4G Bands					
Band Number	5GNR / FR1 / LTE / LTE-Advanced / WCDMA / HSPA / HSPA+ / TD-SCDMA				
	Uplink	Downlink	EMEA	NA	WW
B1	1920 to 1980	2110 to 2170	✓	✓	✓
B2	1850 to 1910	1930 to 1990	✓	✓	✓
B3	1710 to 1785	1805 to 1880	✓	✓	✓
B4	1710 to 1755	2110 to 2155	✓	✓	✓
B5	824 to 849	869 to 894	✓	✓	✓
B7	2500 to 2570	2620 to 2690	✓	*	✓
B8	880 to 915	925 to 960	✓	✓	✓
B9	1749.9 to 1784.9	1844.9 to 1879.9	✓	✓	✓
B11	1427.9 to 1447.9	1475.9 to 1495.9	✓	✓	✓
B12	699 to 716	729 to 746	*	✓	✓
B13	777 to 787	746 to 756	✓	✓	✓
B14	788 to 798	758 to 768	✓	✓	✓
B17	704 to 716	734 to 746	*	✓	✓
B18	815 to 830	860 to 875	✓	✓	✓
B19	830 to 845	875 to 890	✓	✓	✓
B20	832 to 862	791 to 821	✓	✓	✓
B21	1447.9 to 1462.9	1495.9 to 1510.9	✓	✓	✓
B22	3410 to 3490	3510 to 3590	*	*	*
B23	2000 to 2020	2180 to 2200	✓	✓	✓
B24	1626.5 to 1660.5	1525 to 1559	✓	✓	✓
B25	1850 to 1915	1930 to 1995	✓	✓	✓
B26	814 to 849	859 to 894	✓	✓	✓
B27	807 to 824	852 to 869	✓	✓	✓
B28	703 to 748	758 to 803	✓	✓	✓
B29		717 to 728	✓	✓	✓
B30	2305 to 2315	2350 to 2360	✓	✓	✓
B31	452.5 to 457.5	462.5 to 467.5	*	*	*
B32		1452 to 1496	✓	✓	✓
B34		2010 to 2025	✓	✓	✓
B35		1850 to 1910	✓	✓	✓
B36		1930 to 1990	✓	✓	✓
B37		1910 to 1930	✓	✓	✓
B38		2570 to 2620	✓	*	✓
B39		1880 to 1920	✓	✓	✓
B40		2300 to 2400	✓	✓	✓
B41		2496 to 2690	✓	*	✓
B42		3400 to 3600	*	*	*
B43		3600 to 3800	*	*	*
B45		1447 to 1467	✓	✓	✓
B46		5150 to 5925	*	*	*
B47		5855 to 5925	*	*	*
B48		3550 to 3700	*	*	*
B49		3550 to 3700	*	*	*
B50		1432 to 1517	✓	✓	✓
B51		1427 to 1432	✓	✓	✓
B52		3300 to 3400	*	*	*
B53		2483.5 to 2495	✓	*	✓
B65	1920 to 2010	2110 to 2200	✓	✓	✓
B66	1710 to 1780	2110 to 2200	✓	✓	✓
B68	698 to 728	753 to 783	✓	✓	✓
B69		2570 to 2620	✓	*	✓
B70	1695 to 1710	1995 to 2020	✓	✓	✓
B71	663 to 698	617 to 652	*	*	✓
B72	451 to 456	461 to 466	*	*	*
B73	450 to 455	460 to 465	*	*	*
B74	1427 to 1470	1475 to 1518	✓	✓	✓
B75		1432 to 1517	✓	✓	✓
B76		1427 to 1432	✓	✓	✓
B77		3300 to 4200	*	*	*
B78		3300 to 3800	*	*	*
B79		4400 to 5000	*	*	*
B85	698 to 716	728 to 746	*	✓	✓
B87	410 to 415	420 to 425	*	*	*
B88	412 to 417	422 to 427	*	*	*

3. Antenna Characteristics

3.1 Return Loss

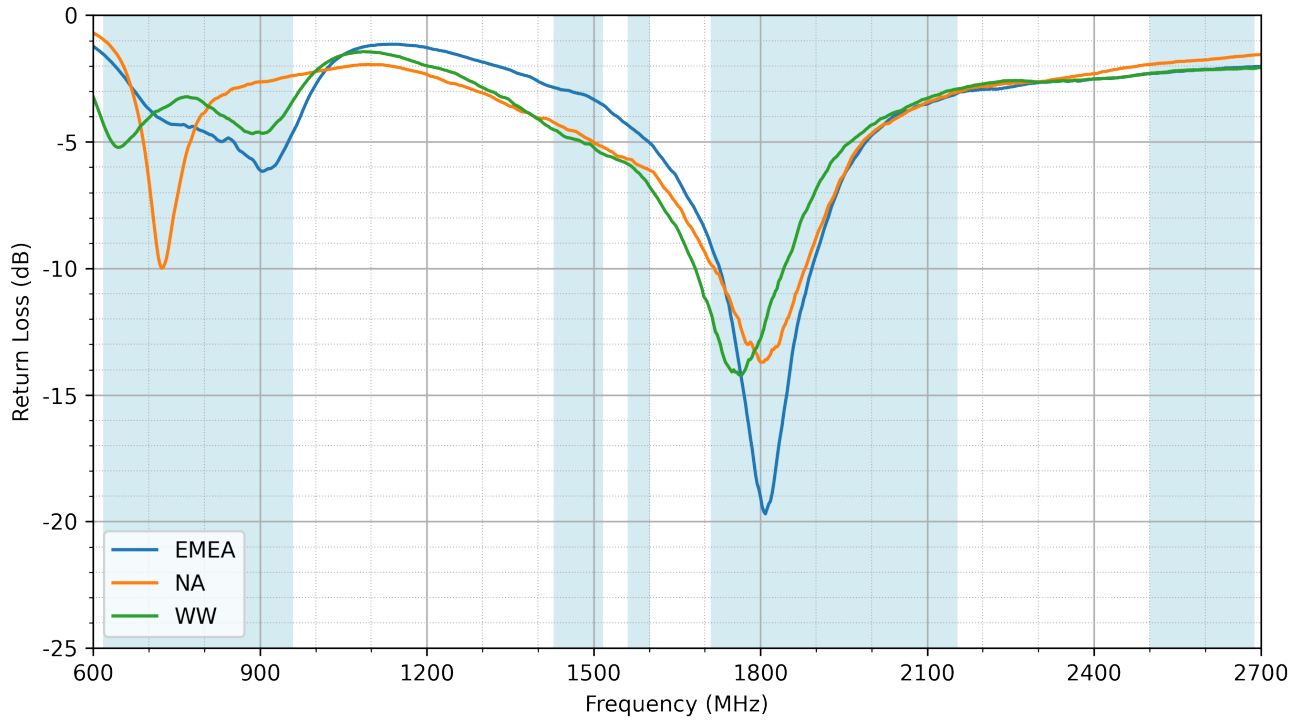

3.2 VSWR

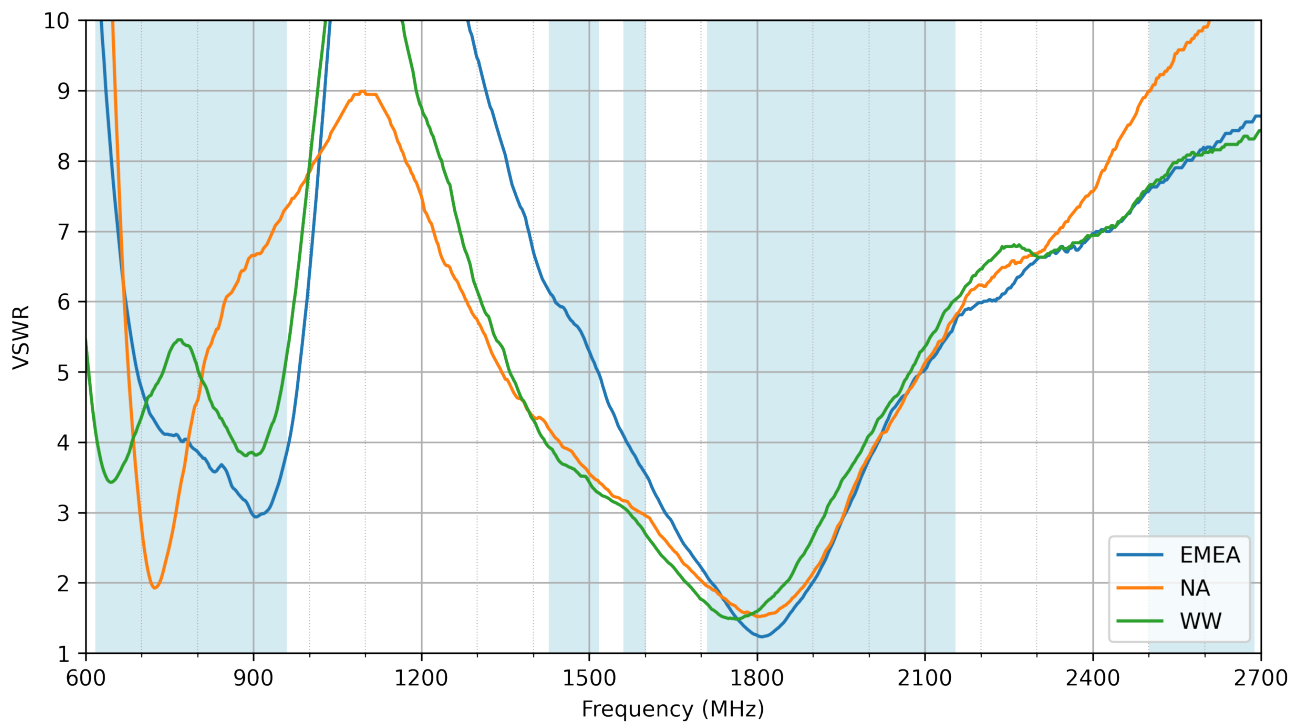

3.3 Efficiency

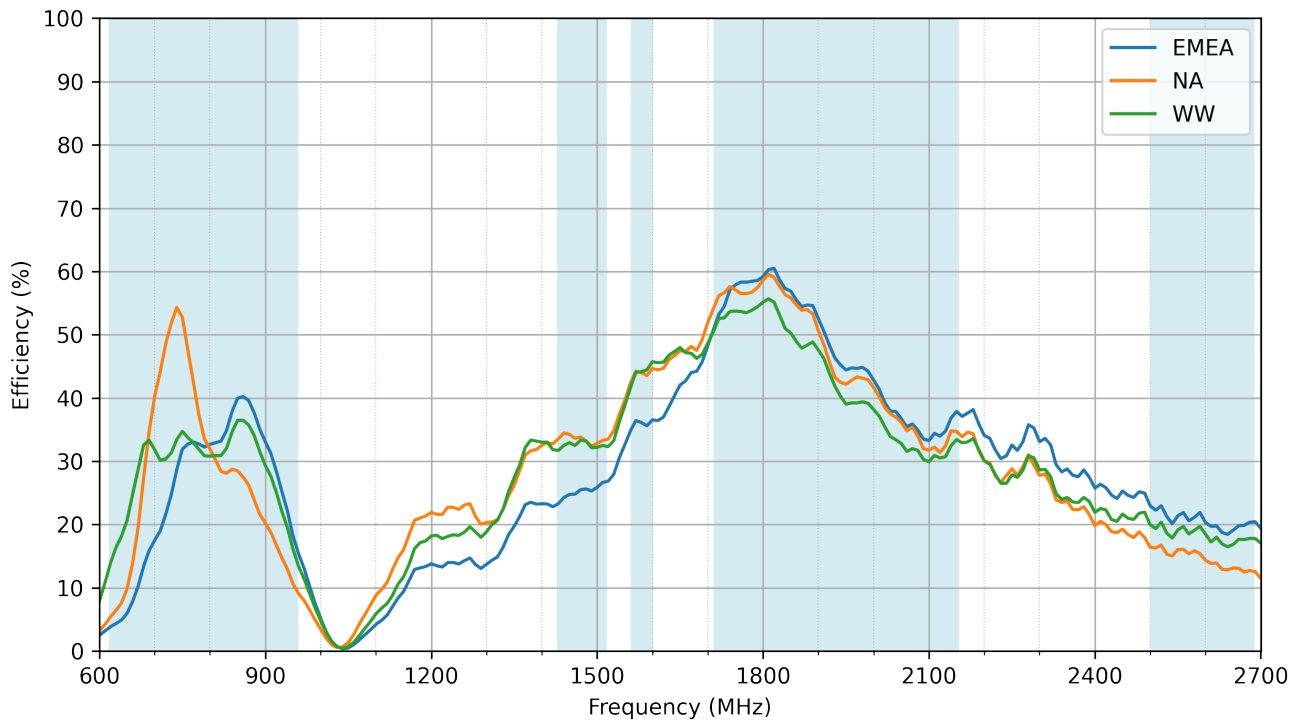

3.4 Average Gain

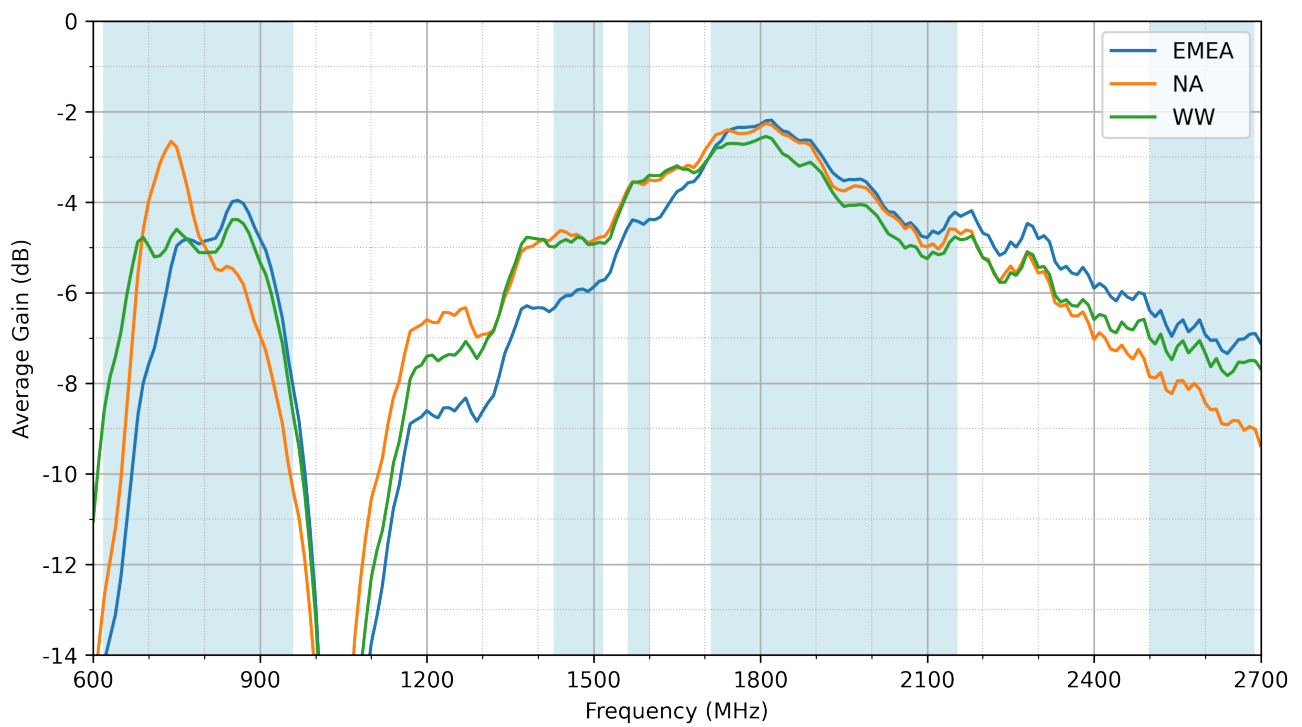

3.5 Peak Gain

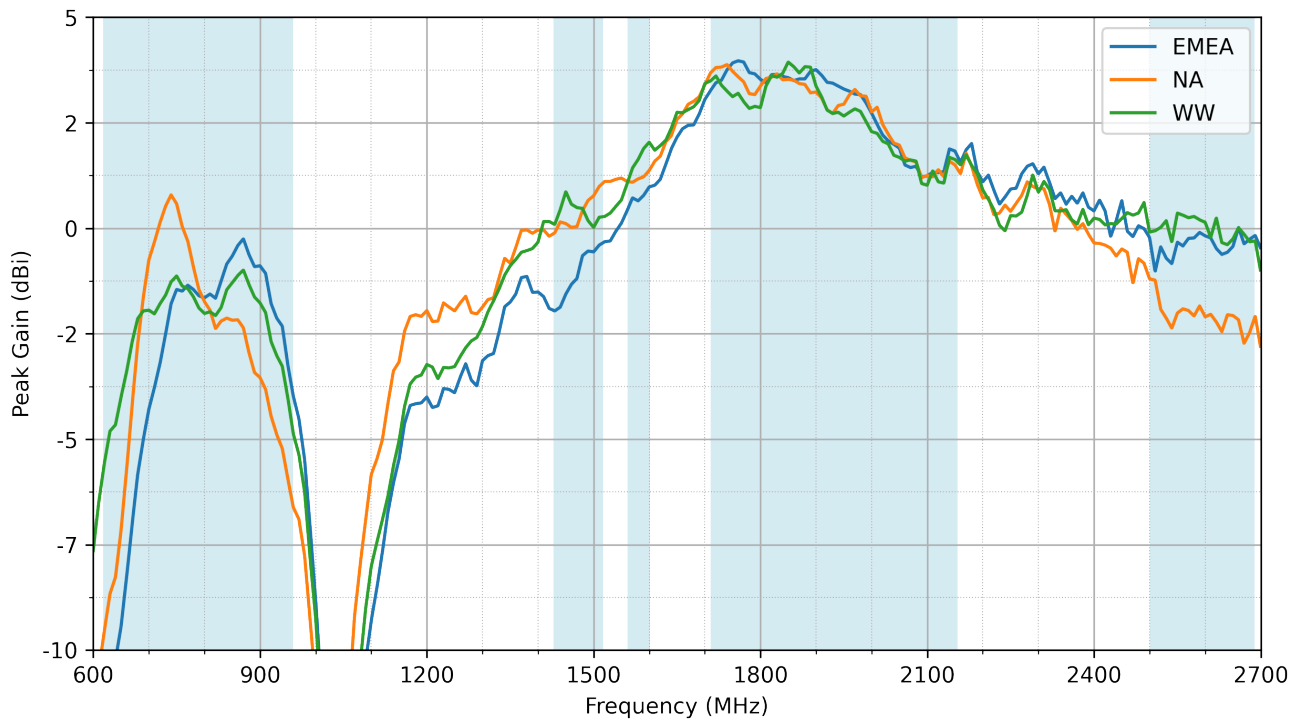

4. Radiation Patterns

4.1 Test Setup

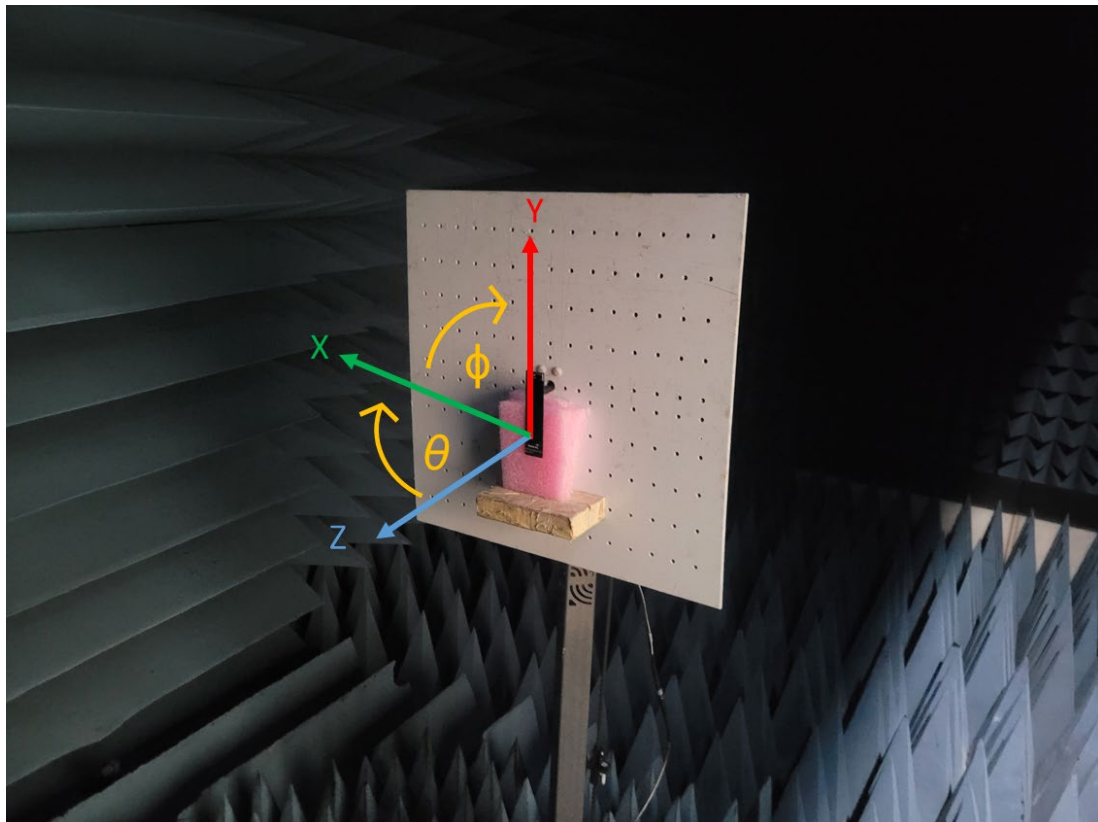
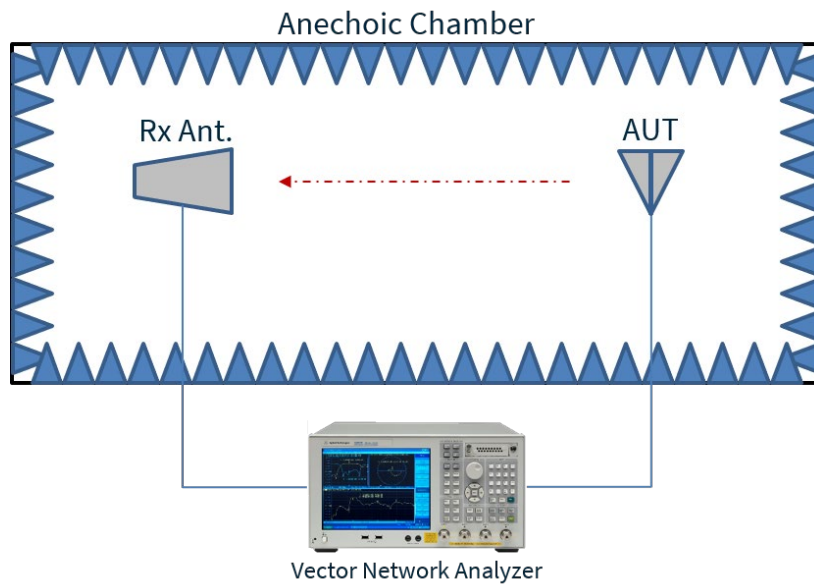

4.2 EMEA Patterns at 650 MHz

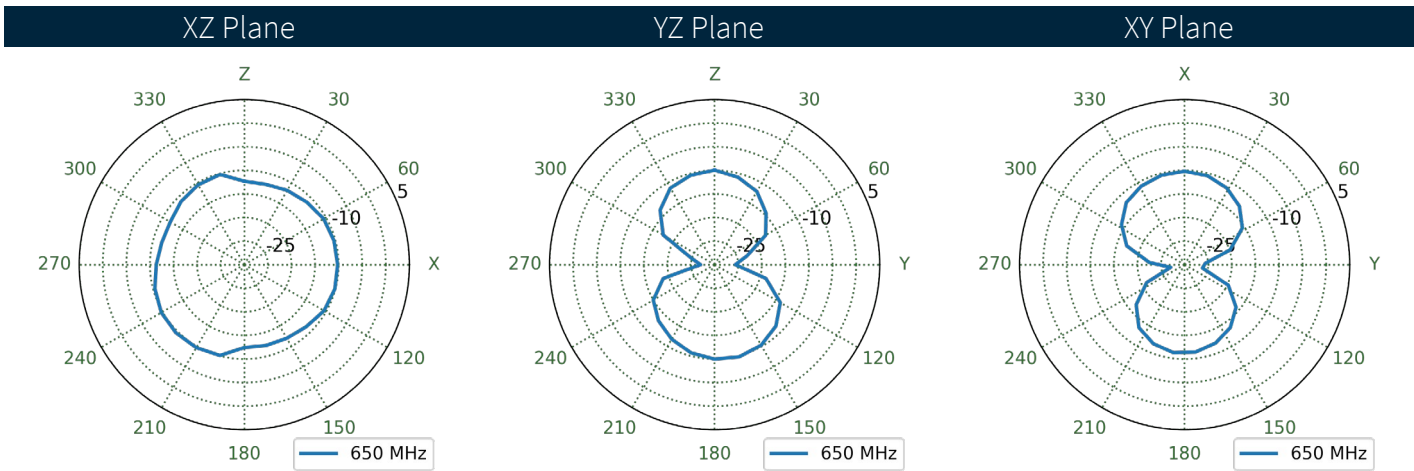
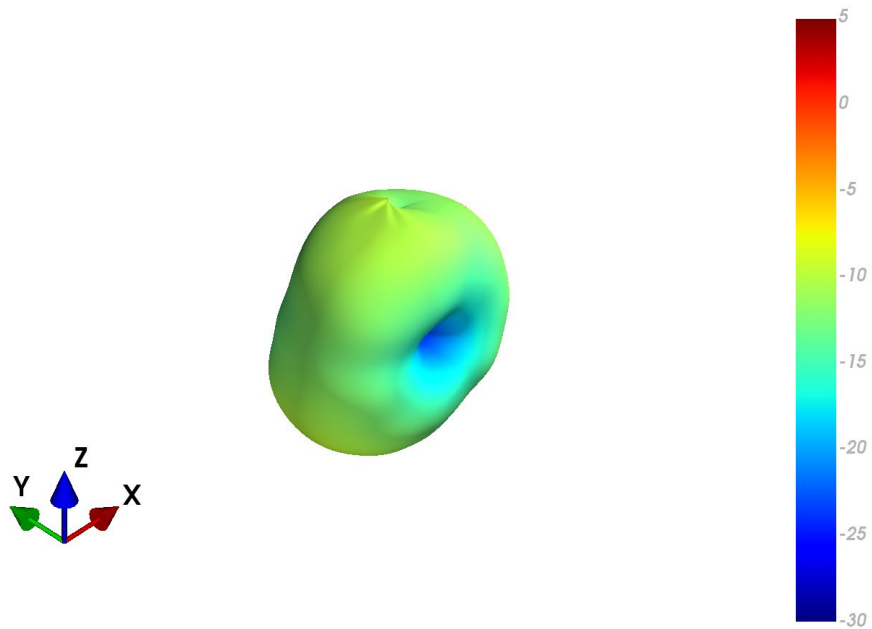

4.3 NA Patterns at 650 MHz

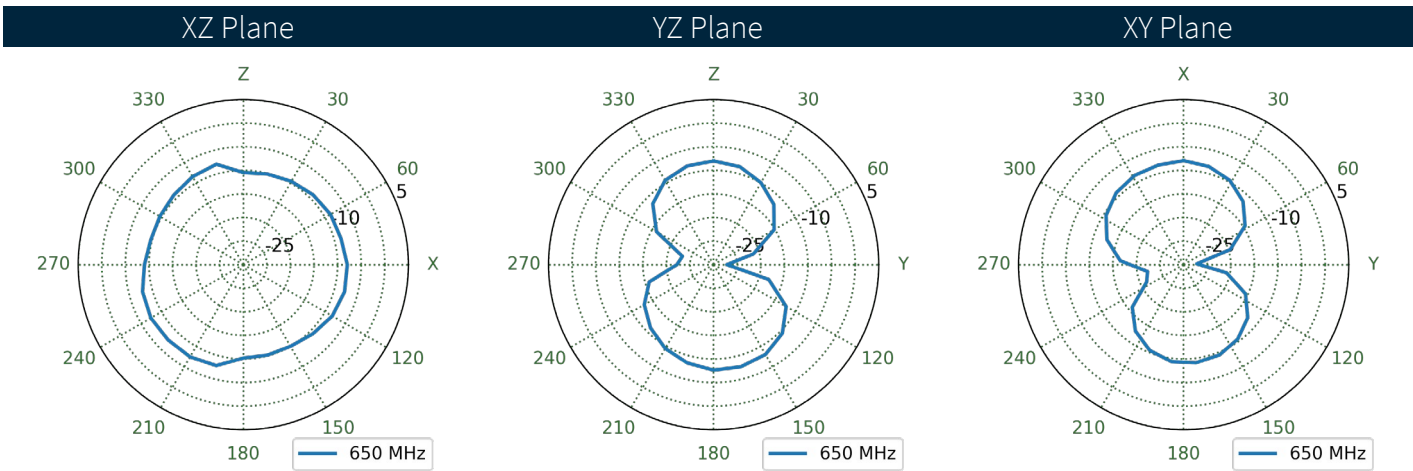
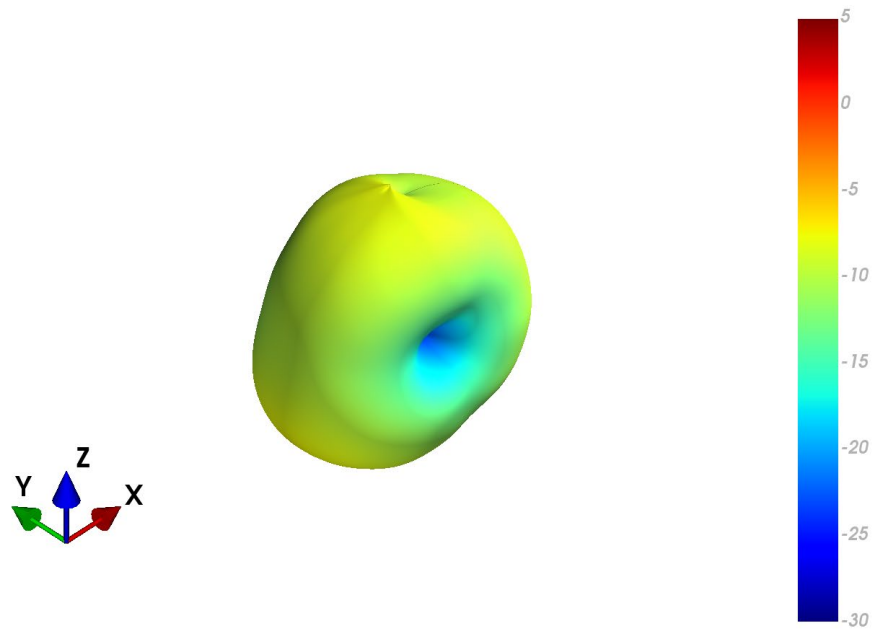

4.4 WW Patterns at 650 MHz

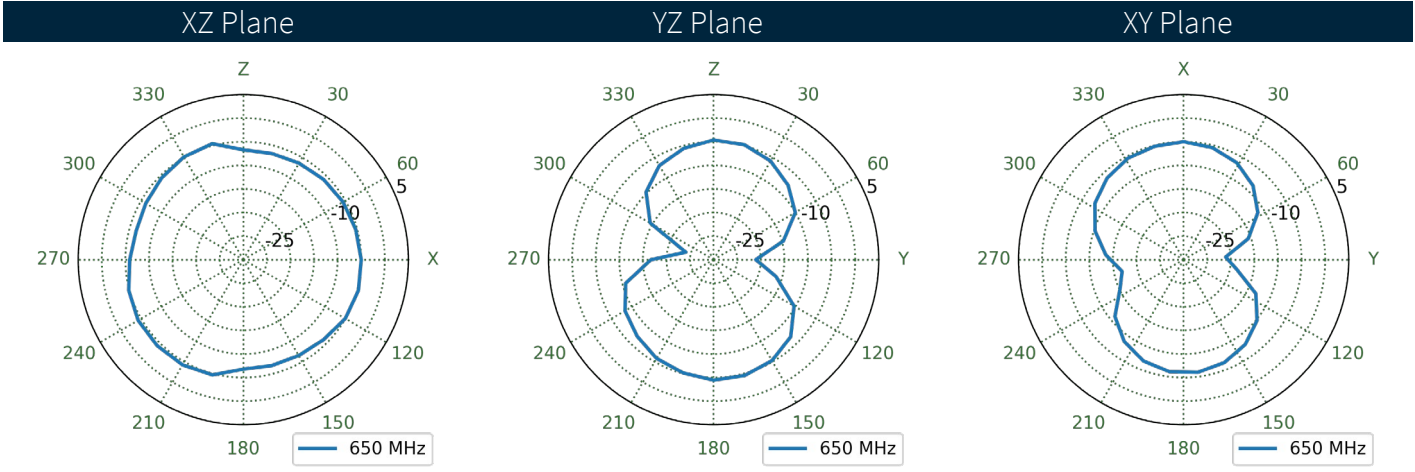
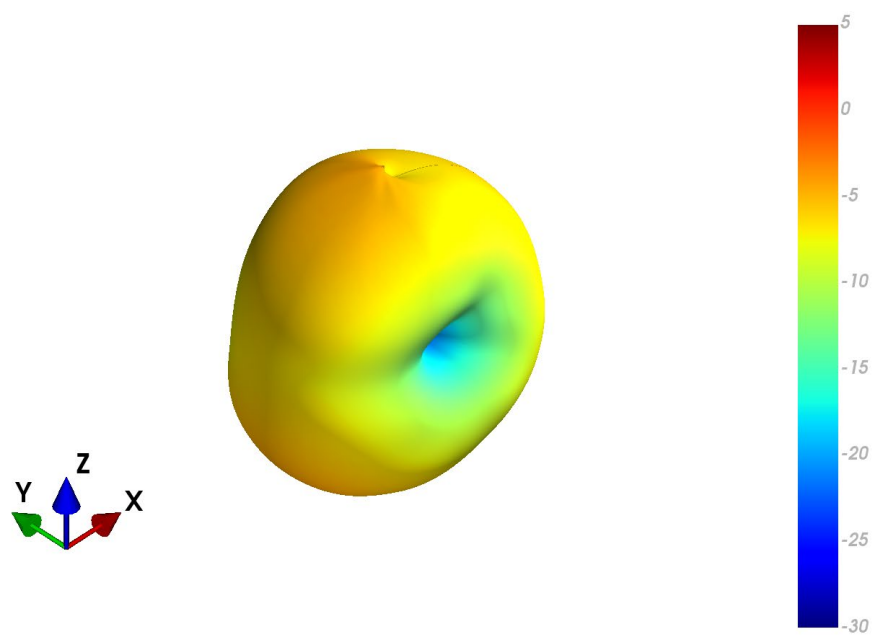

4.5 EMEA Patterns at 700 MHz

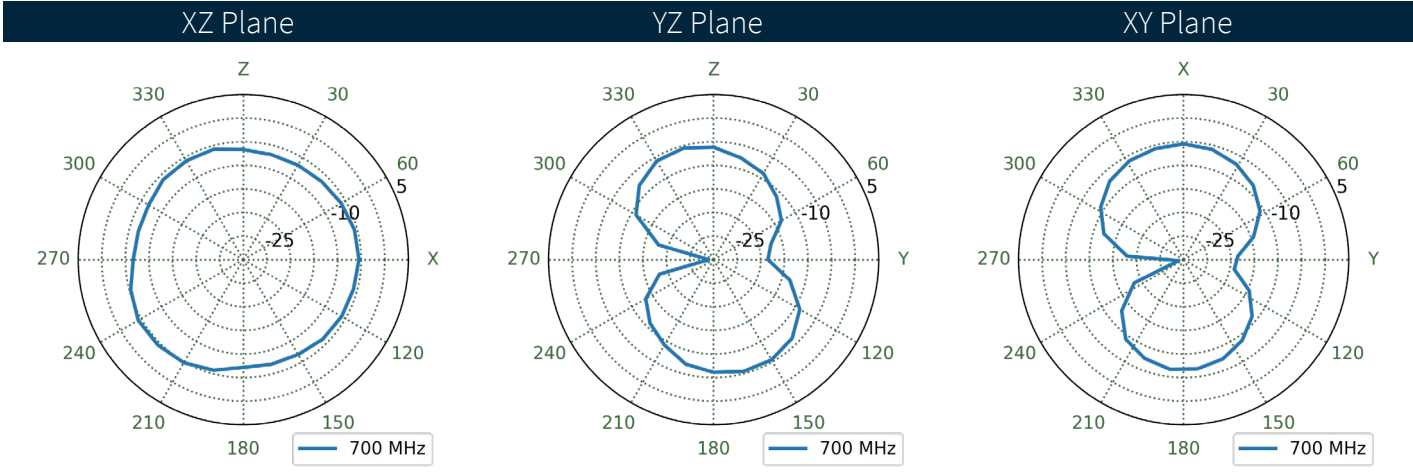
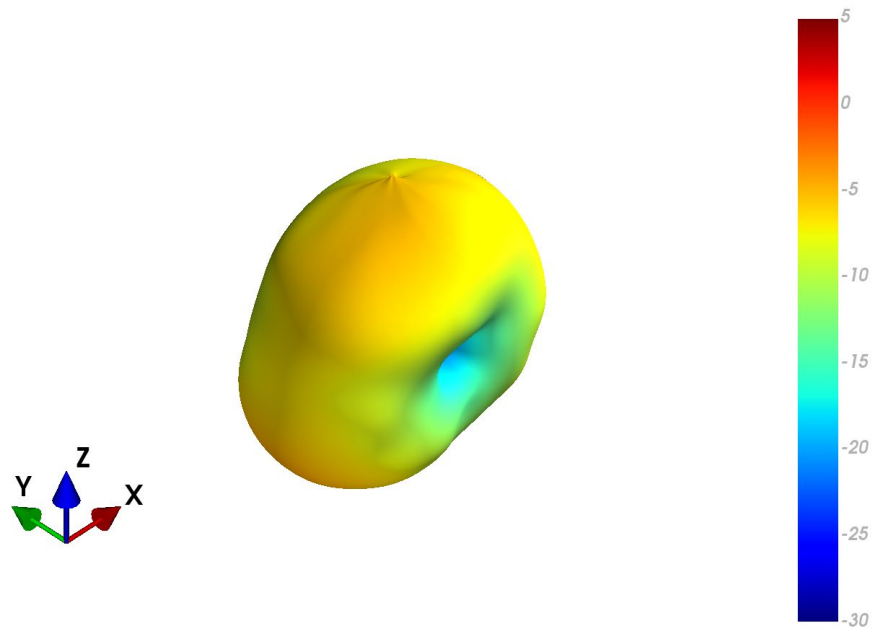

4.6 NA Patterns at 700 MHz

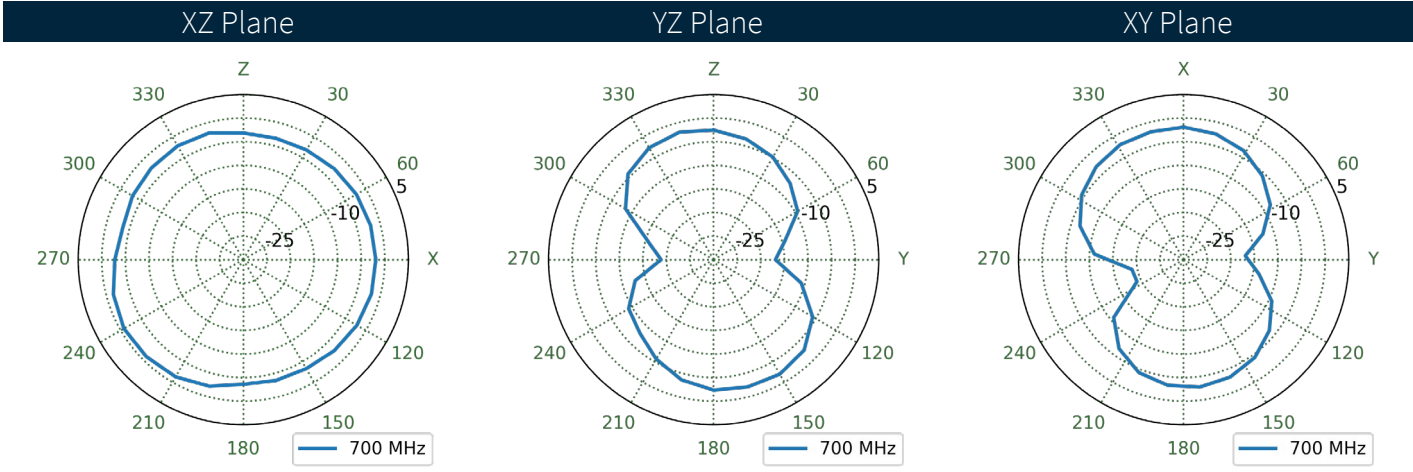
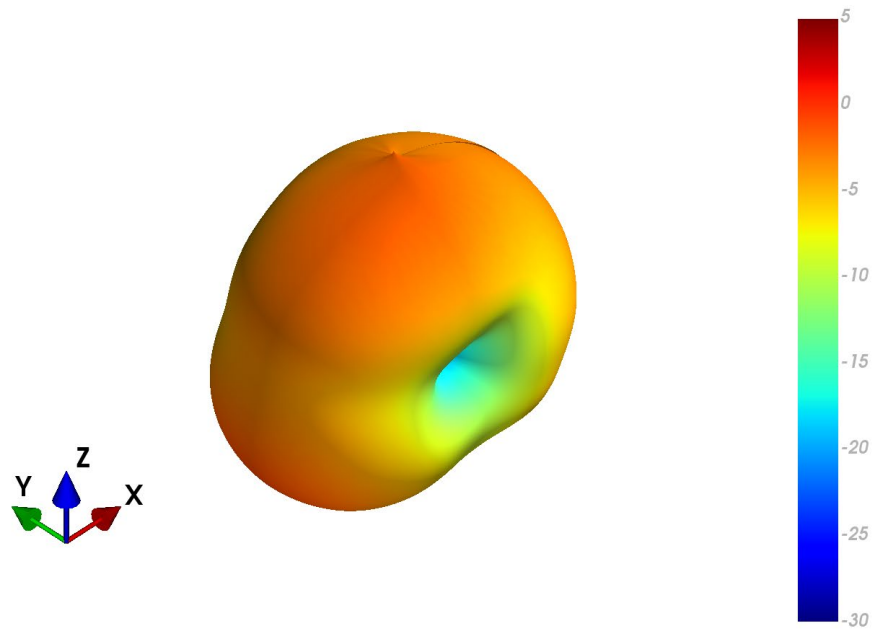

4.7 WW Patterns at 700 MHz

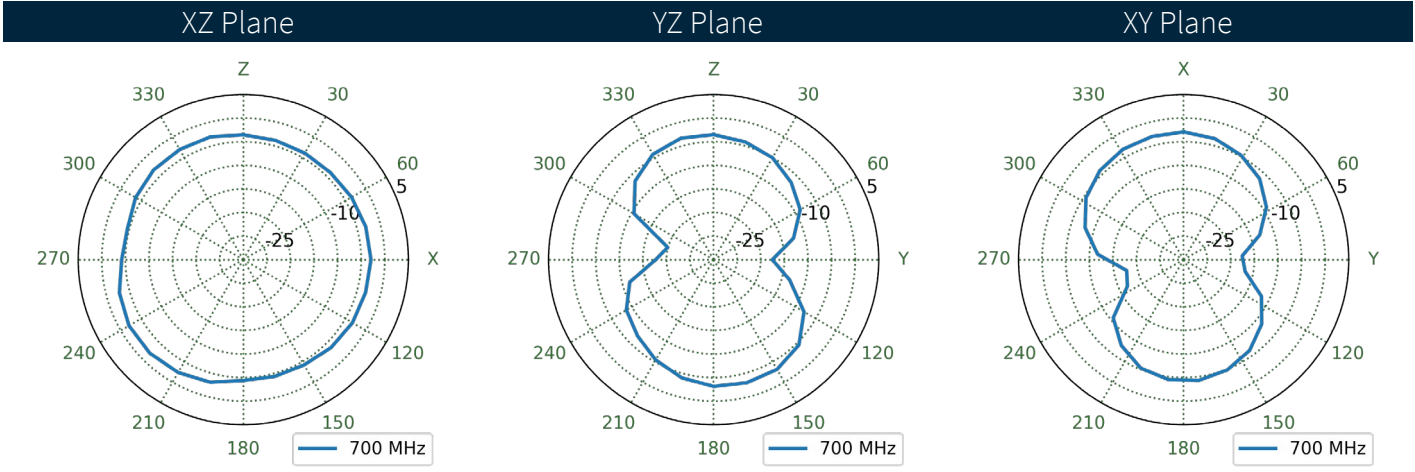
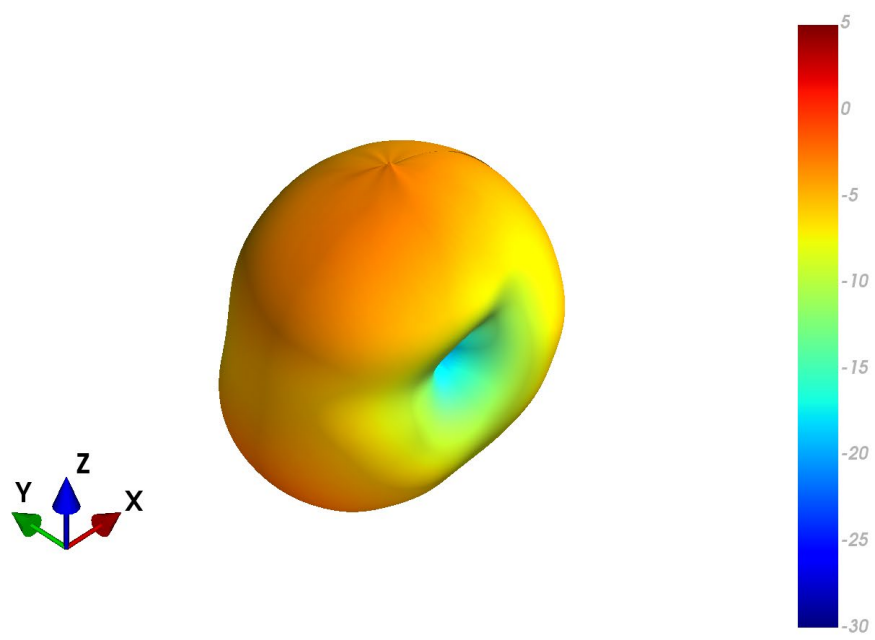

4.8 EMEA Patterns at 850 MHz

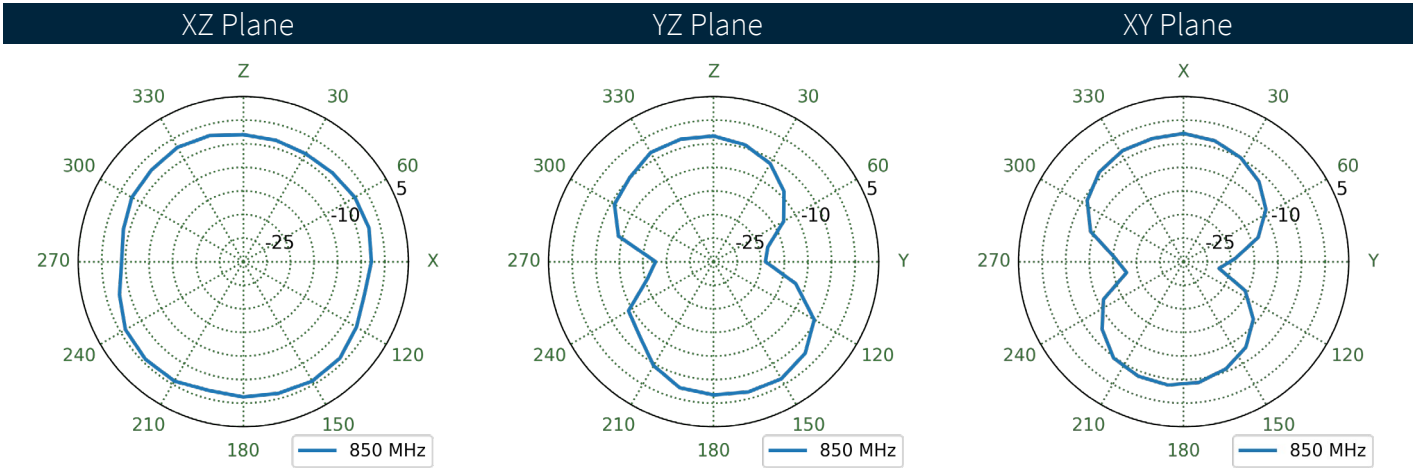
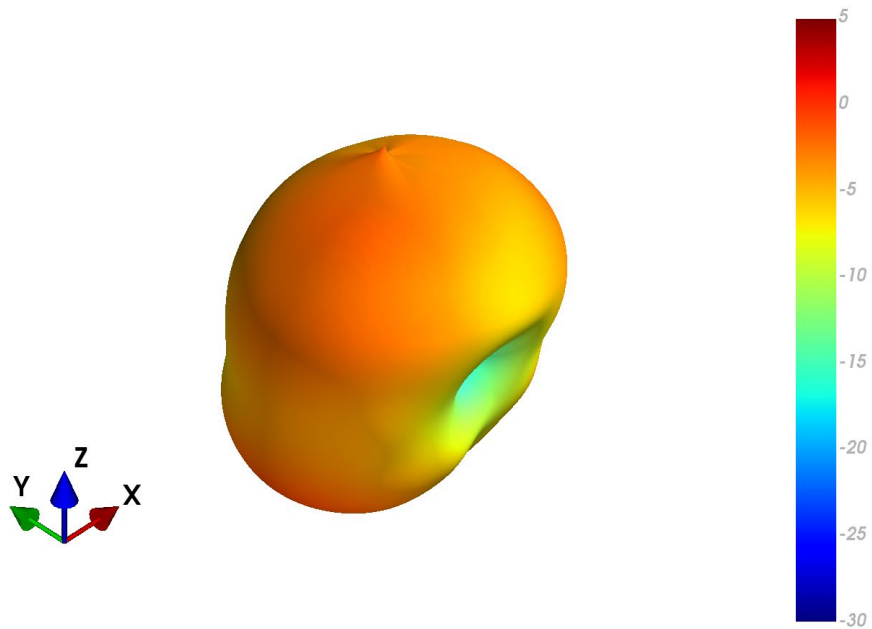

4.9 NA Patterns at 850 MHz

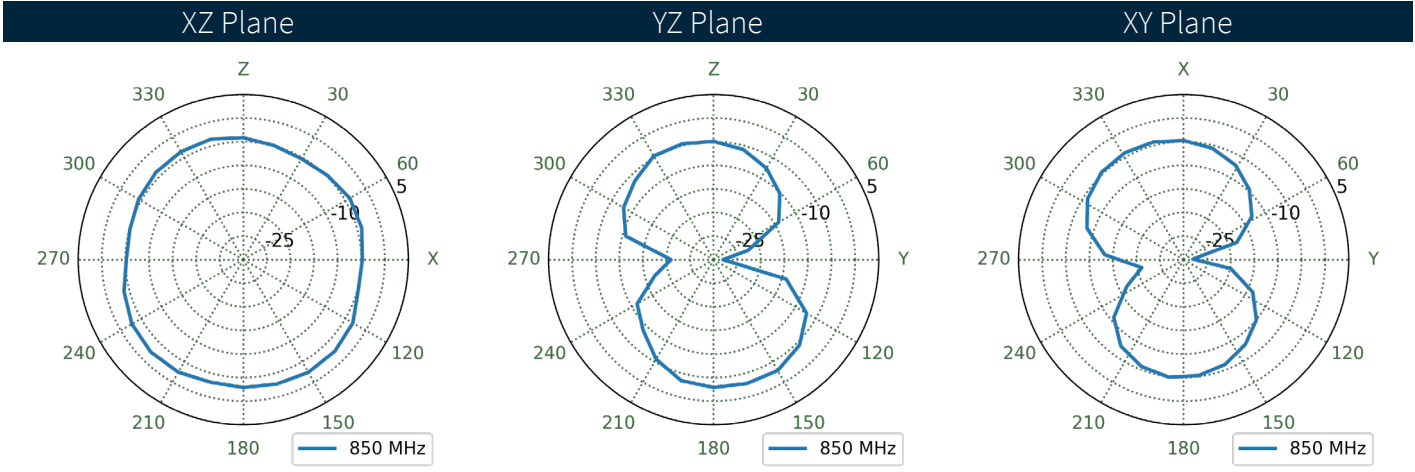
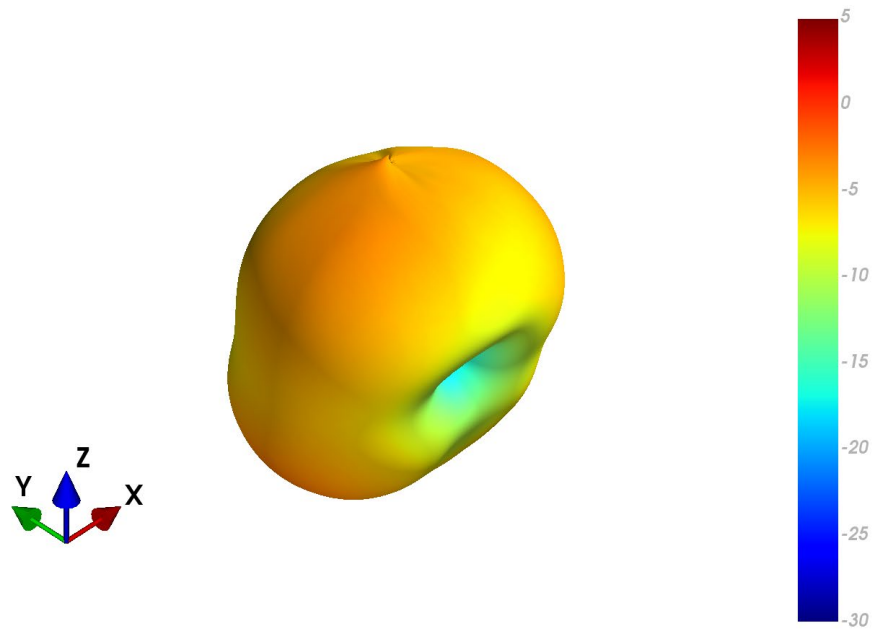

4.10 WW Patterns at 850 MHz

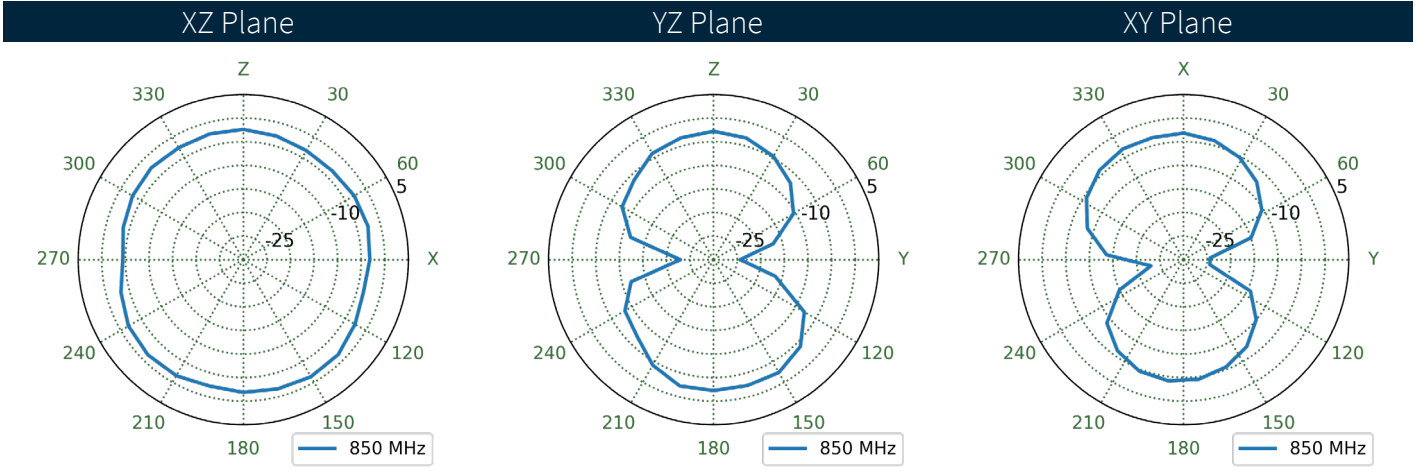
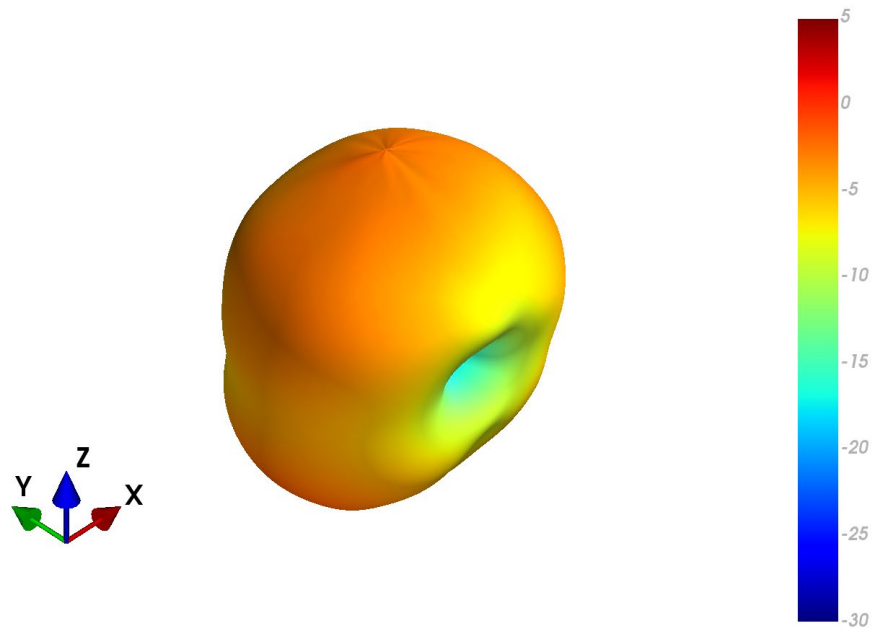

4.11 EMEA Patterns at 900 MHz

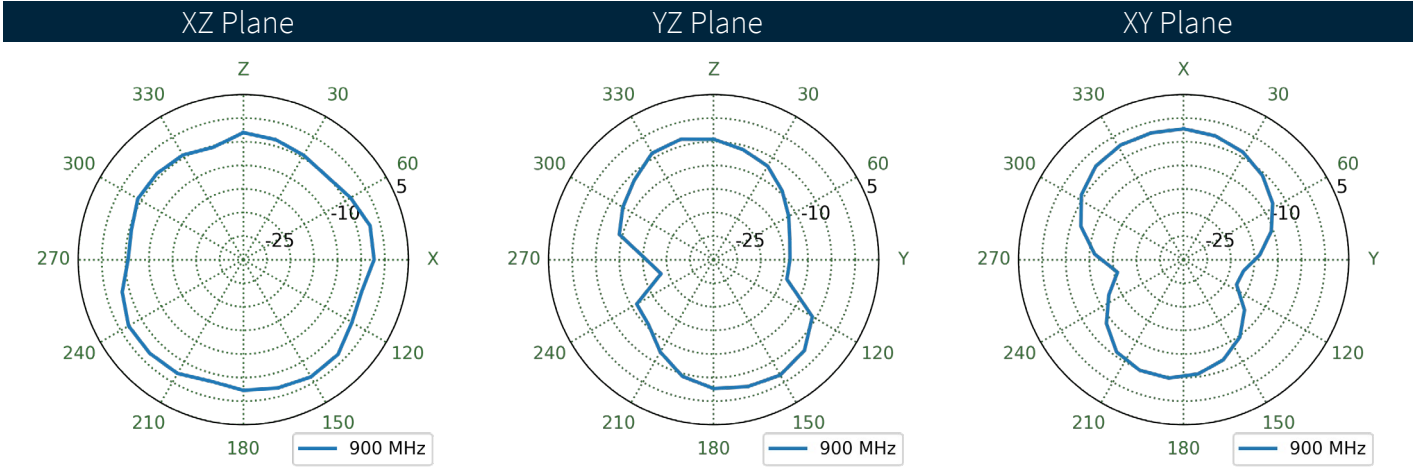
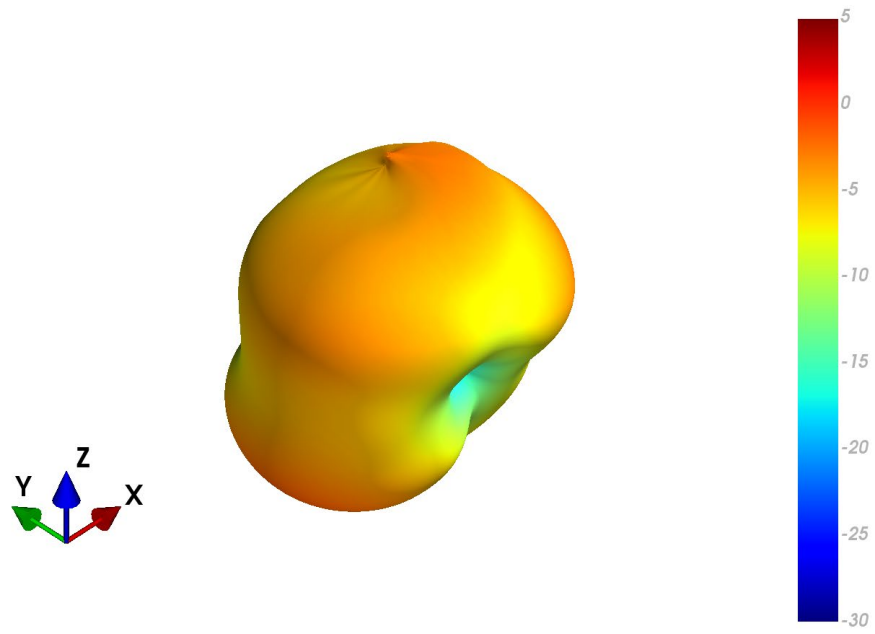

4.12 NA Patterns at 900 MHz

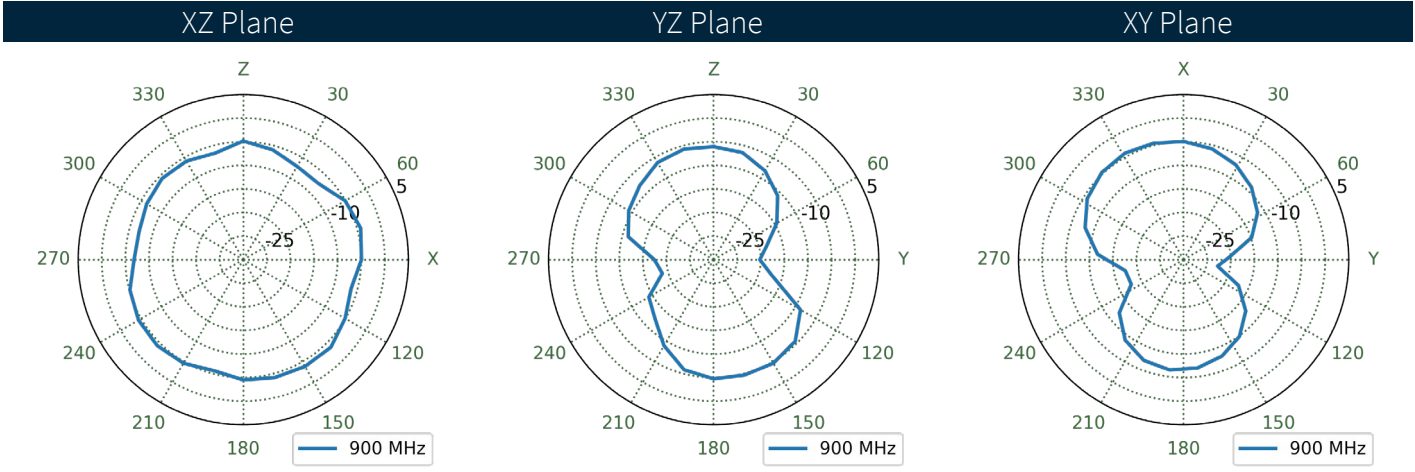
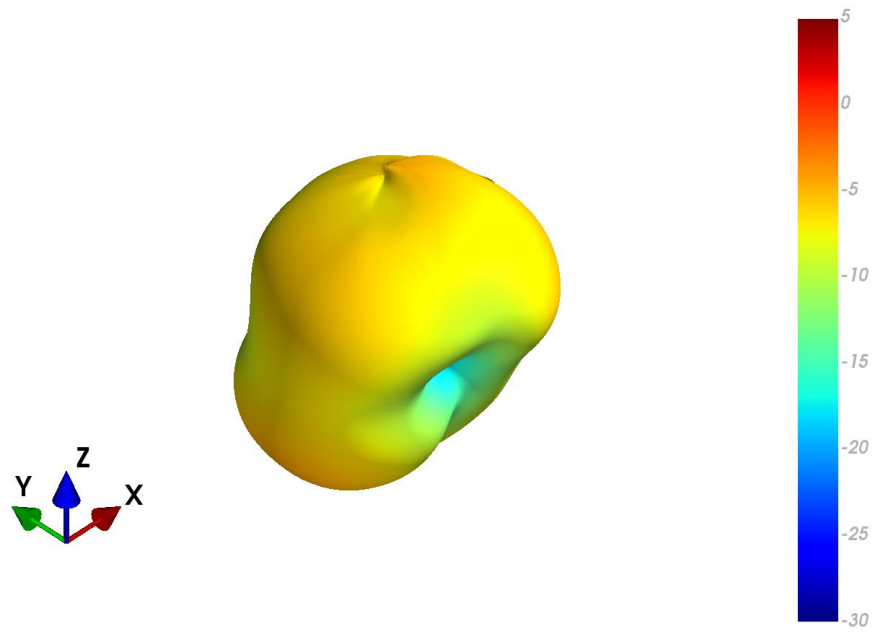

4.13 WW Patterns at 900 MHz

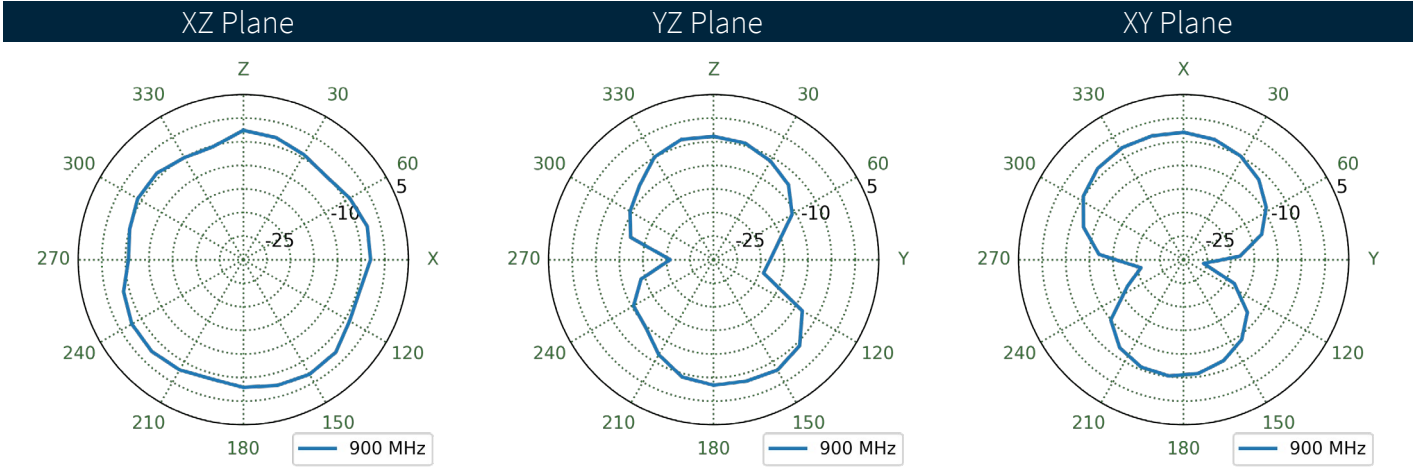
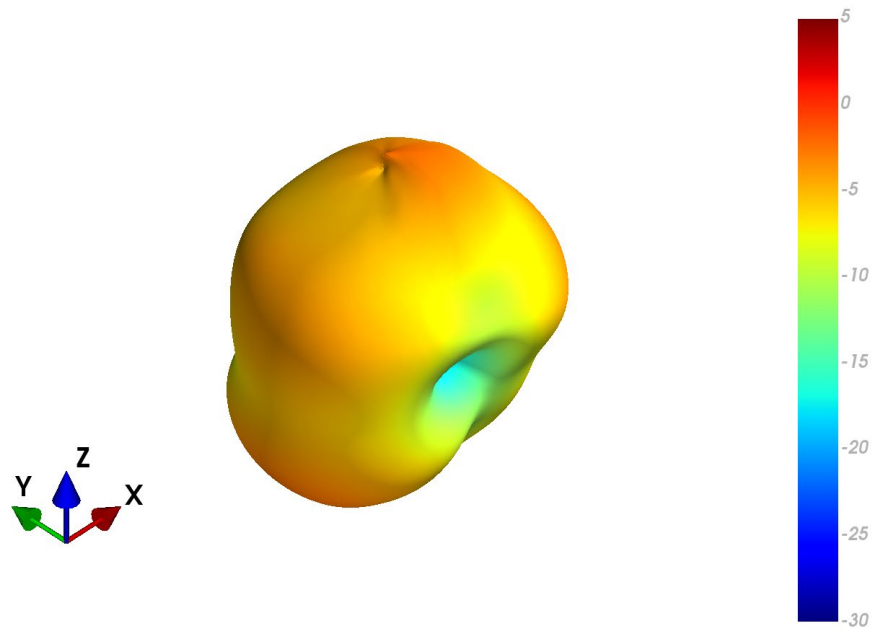

4.14 EMEA Patterns at 960 MHz

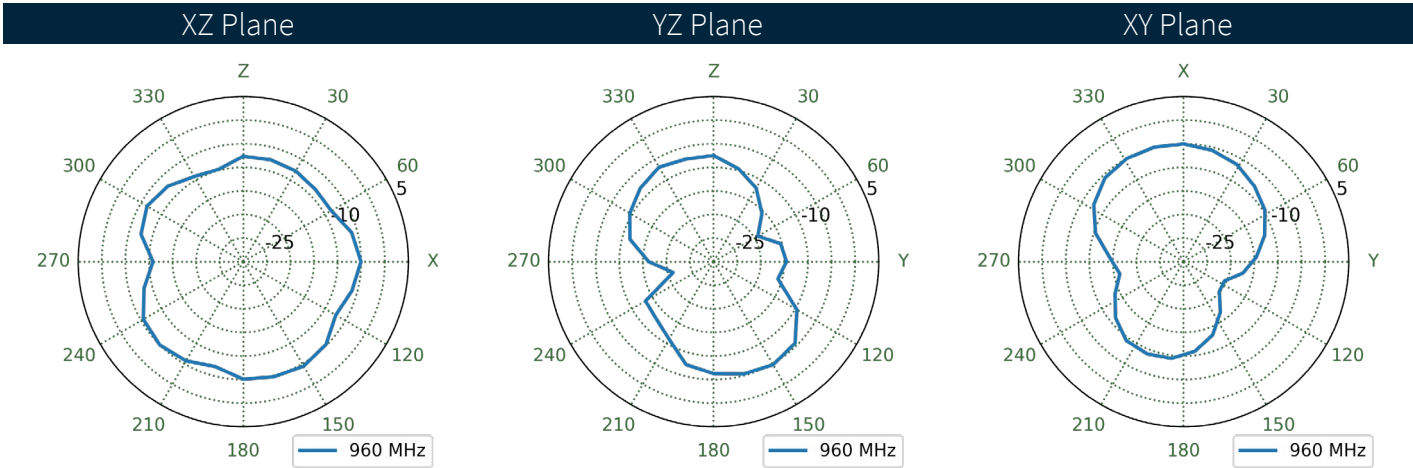
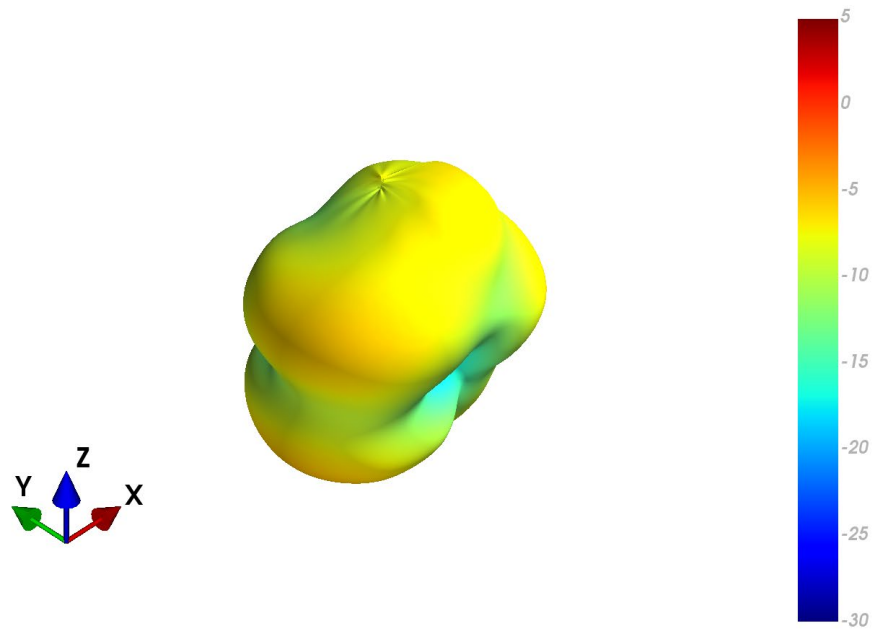

4.15 NA Patterns at 960 MHz

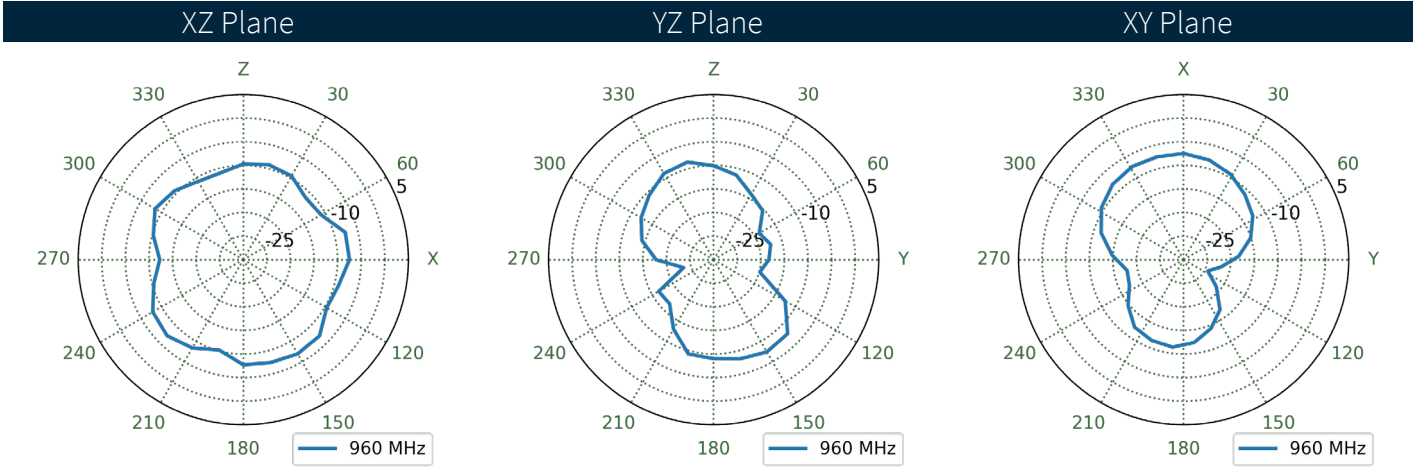
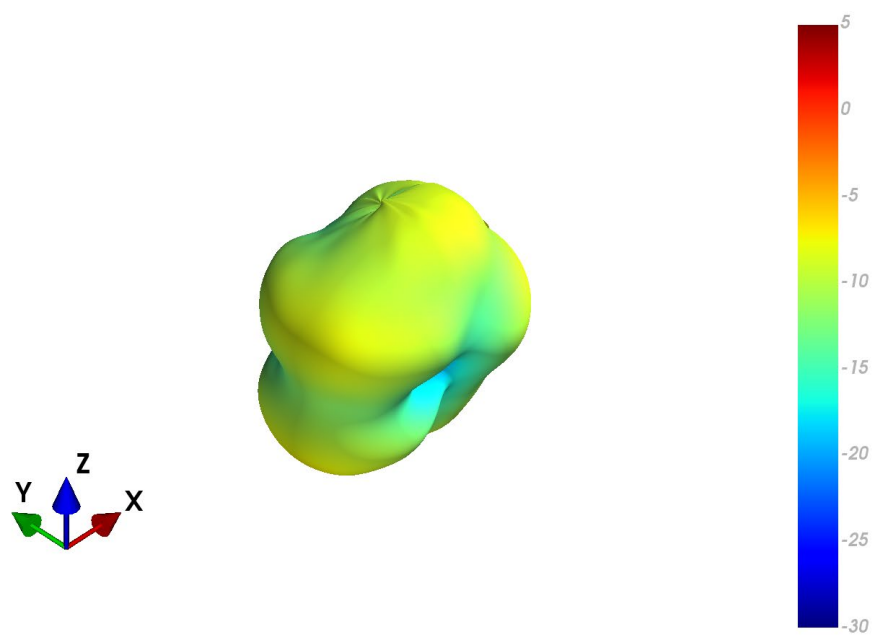

4.16 WW Patterns at 960 MHz

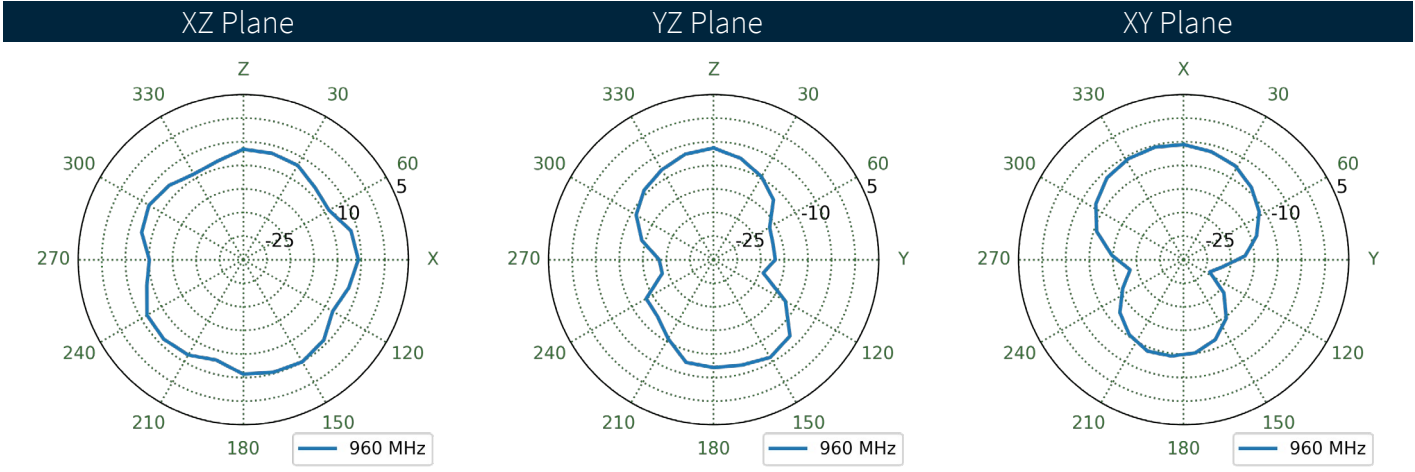
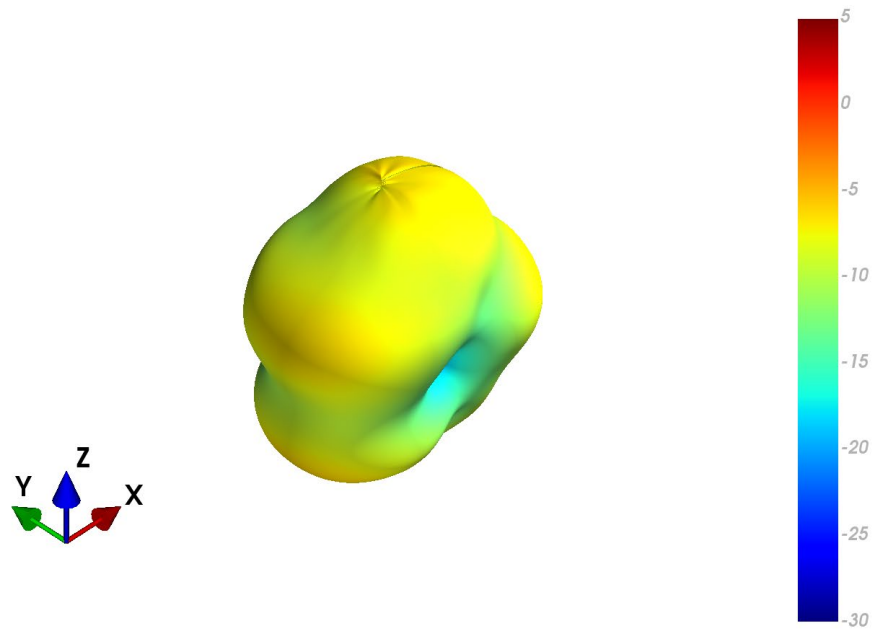

4.17 EMEA Patterns at 1450 MHz

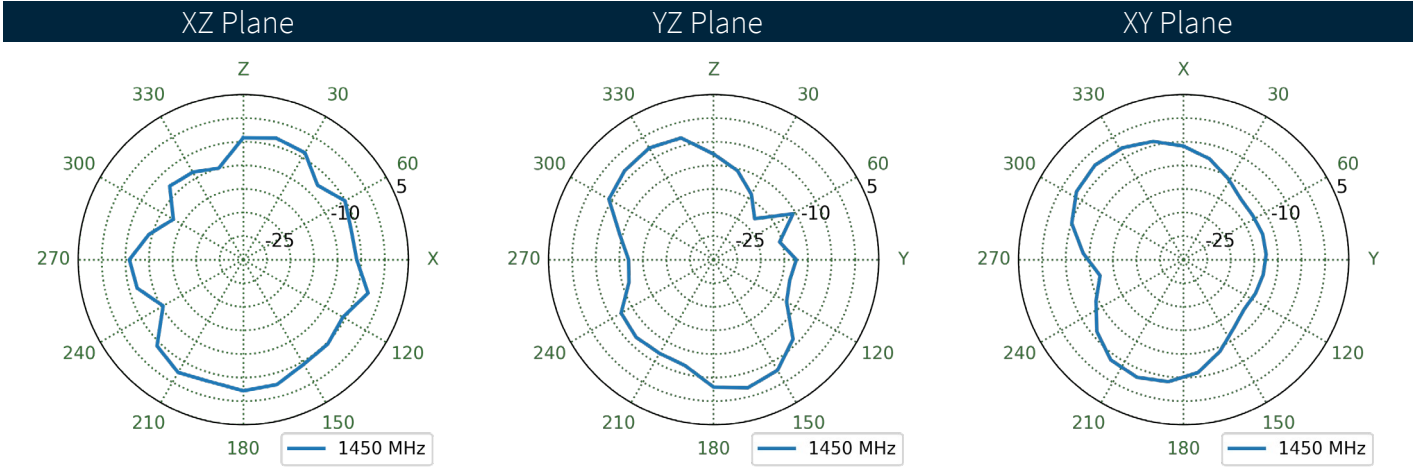
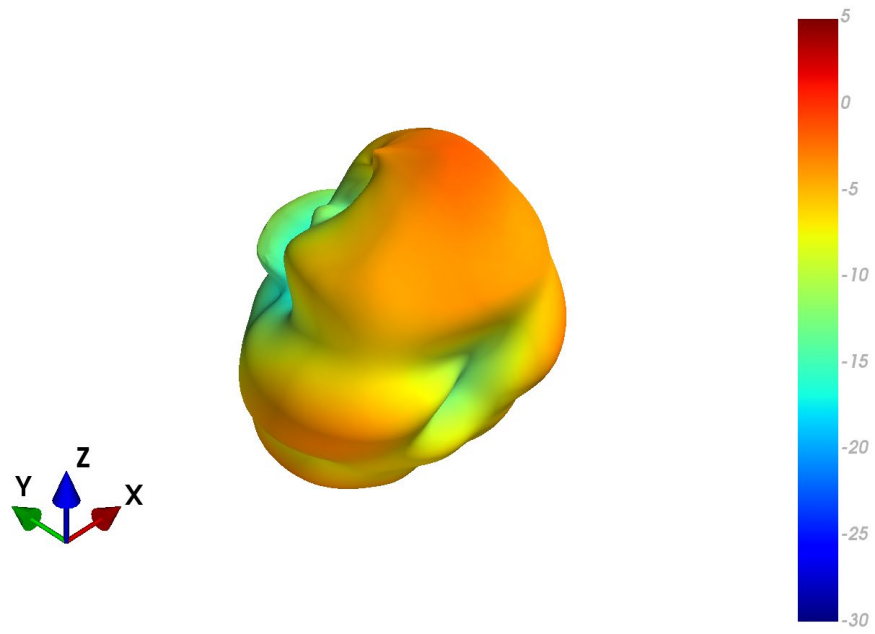

4.18 NA Patterns at 1450 MHz

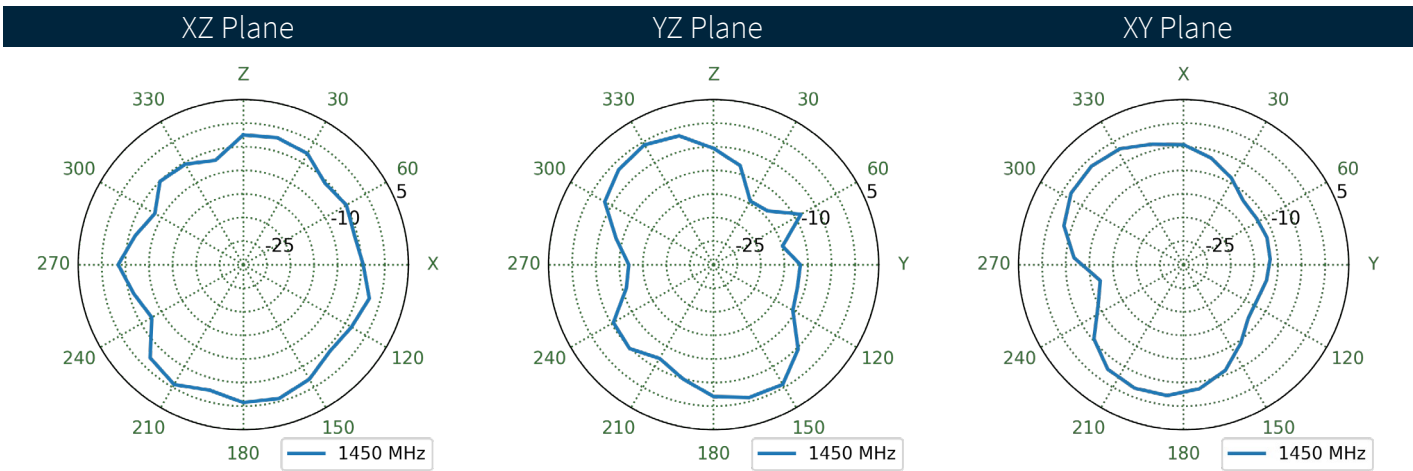
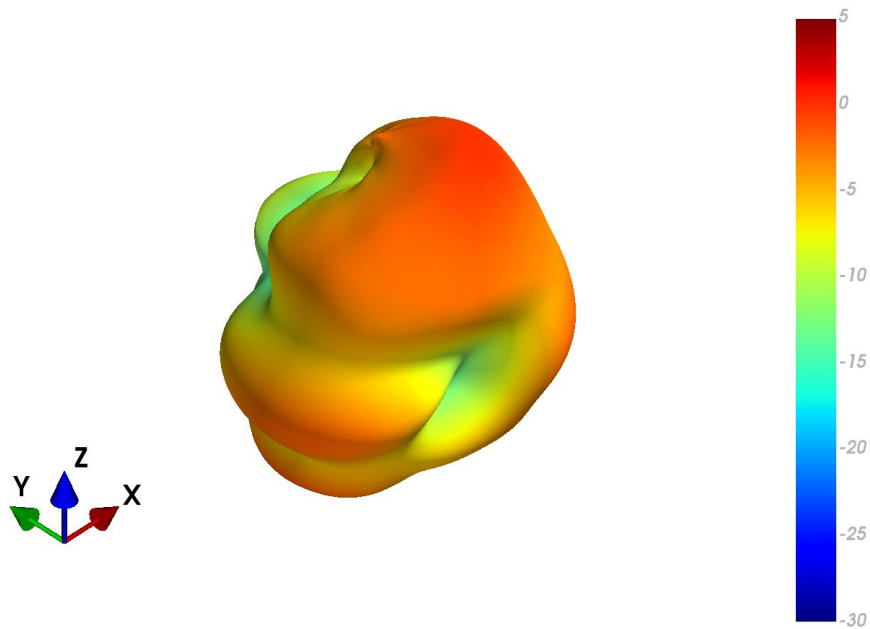

4.19 WW Patterns at 1450 MHz

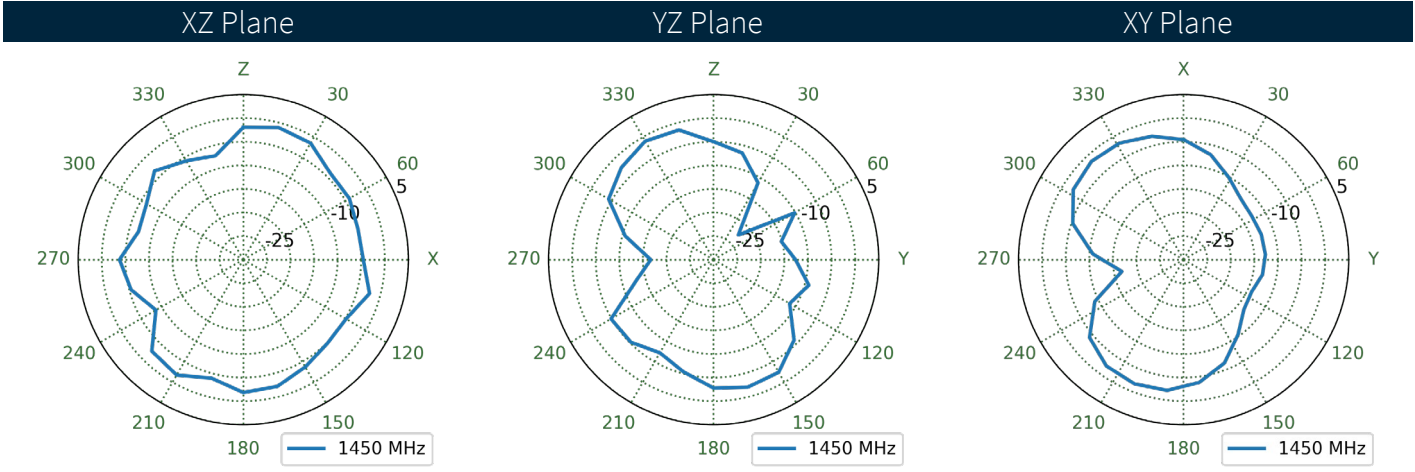
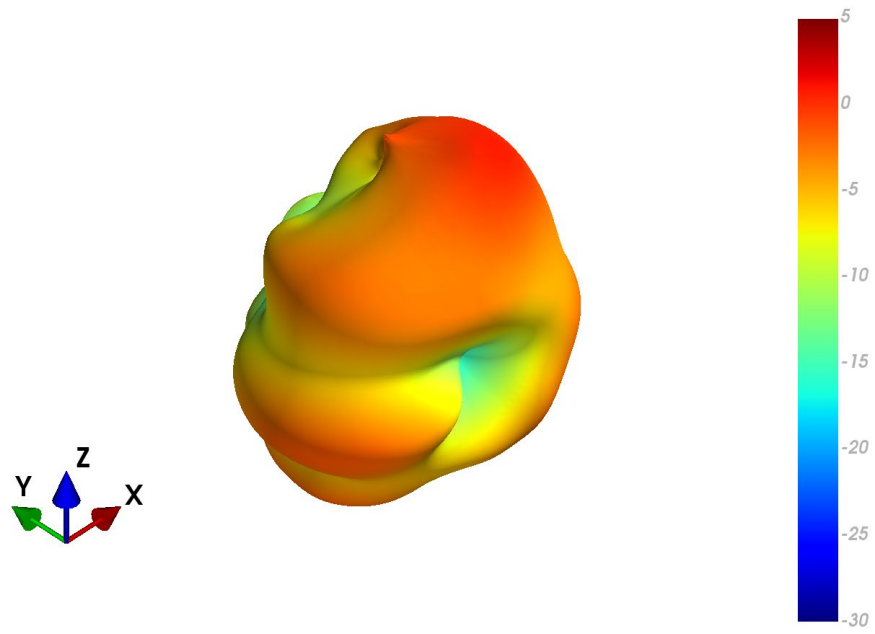

4.20 EMEA Patterns at 1575 MHz

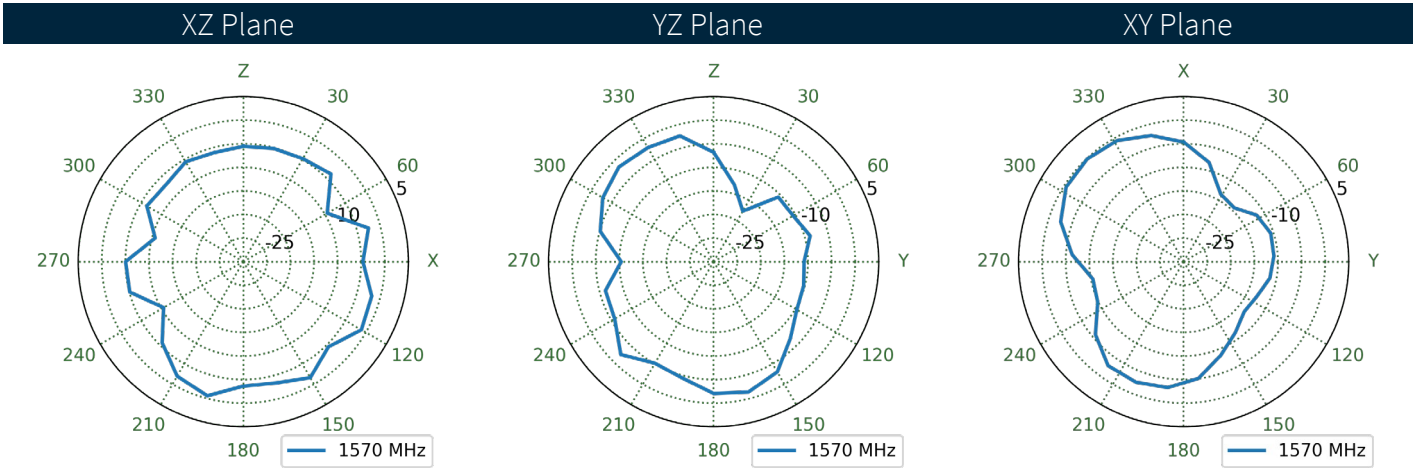
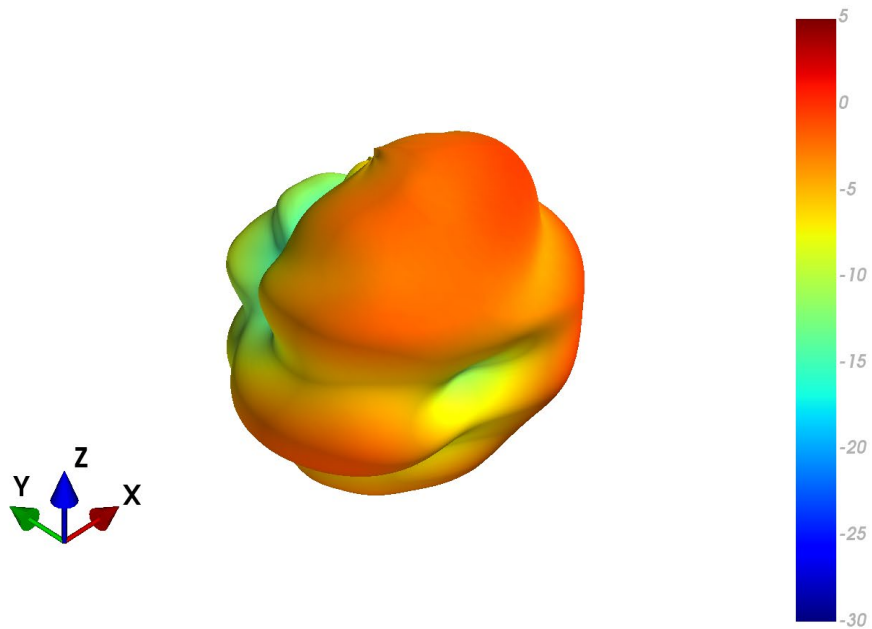

4.21 NA Patterns at 1575 MHz

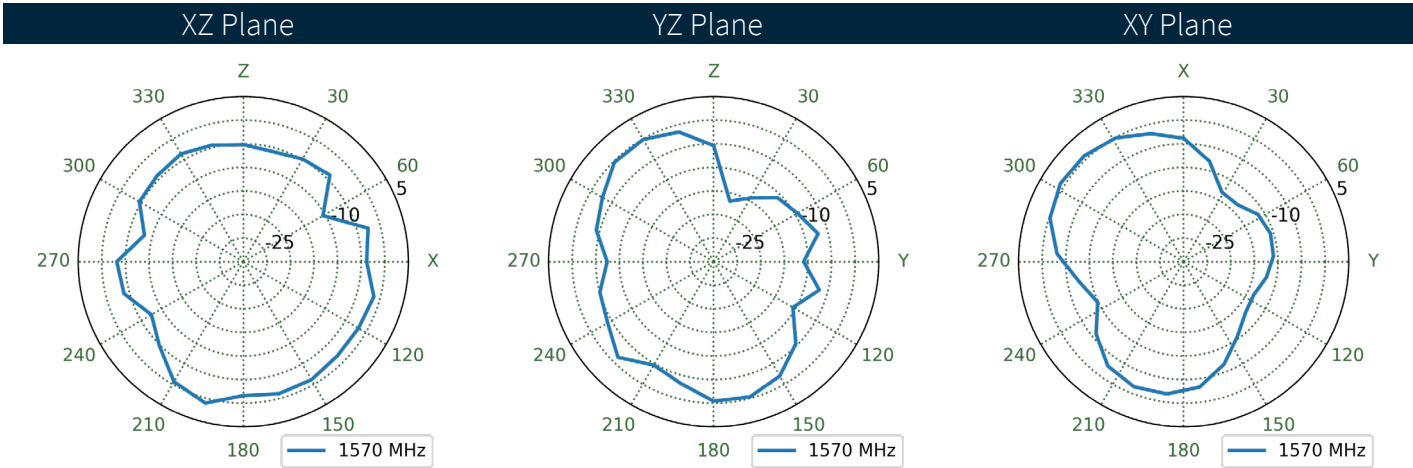
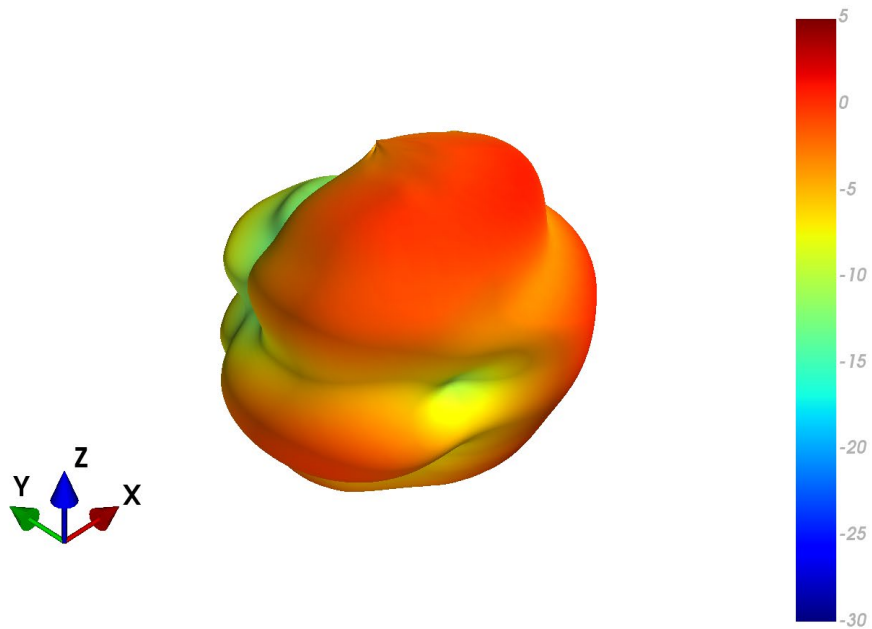

4.22 WW Patterns at 1575 MHz

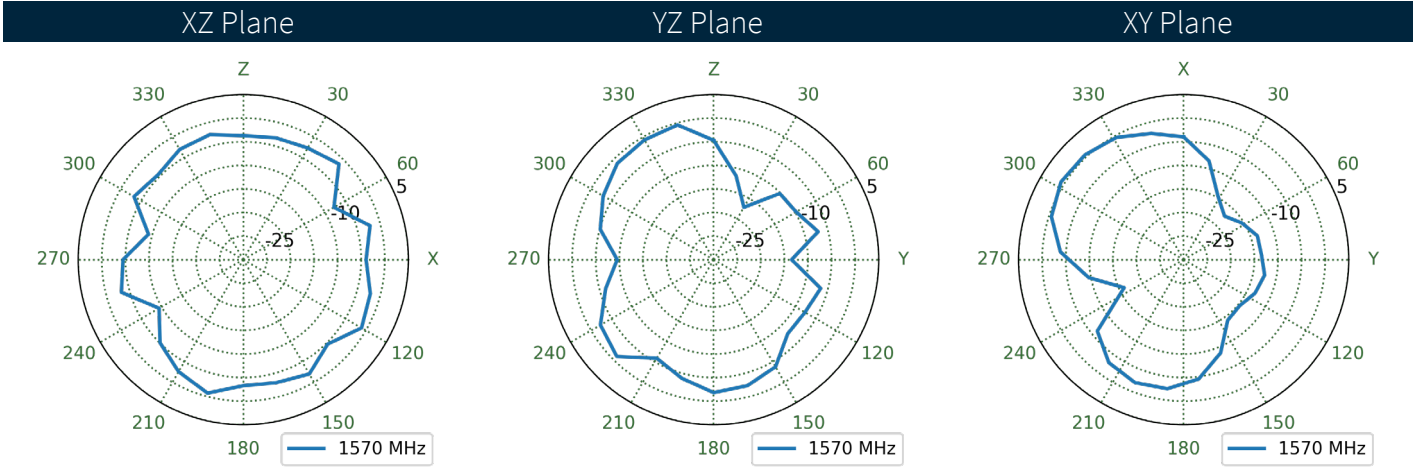
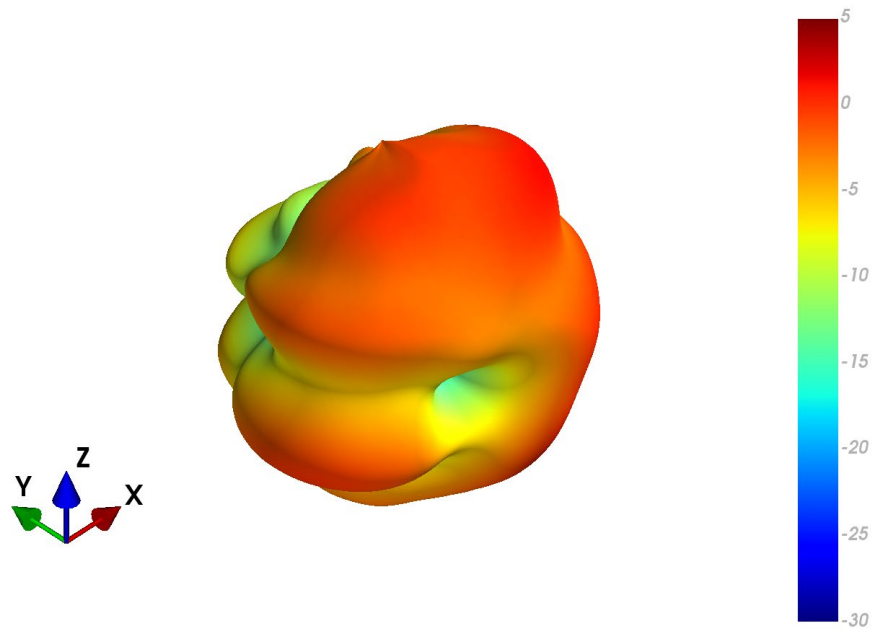

4.23 EMEA Patterns at 1710 MHz

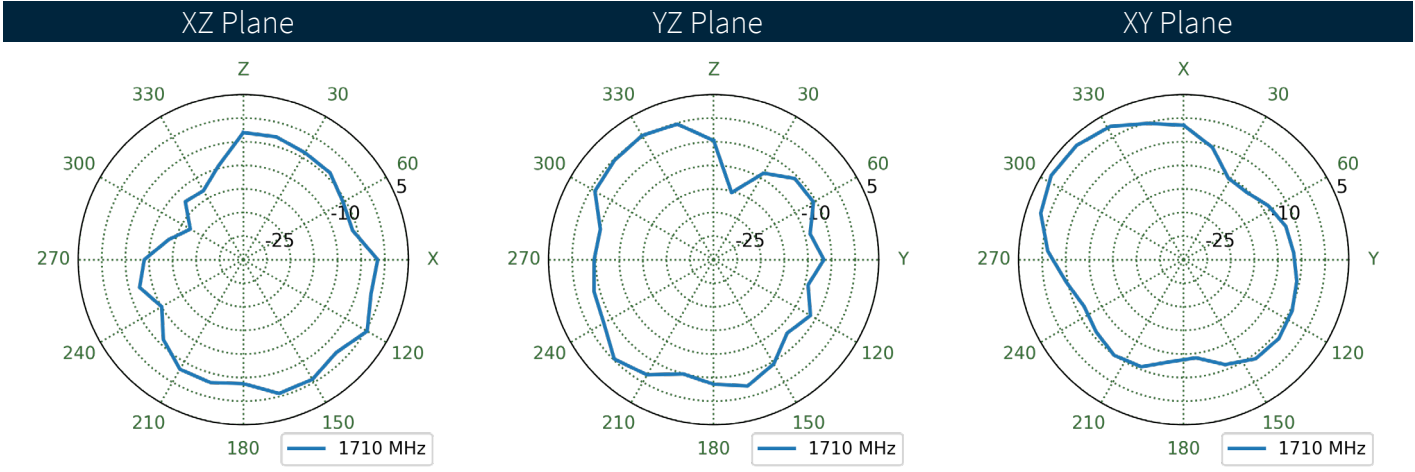
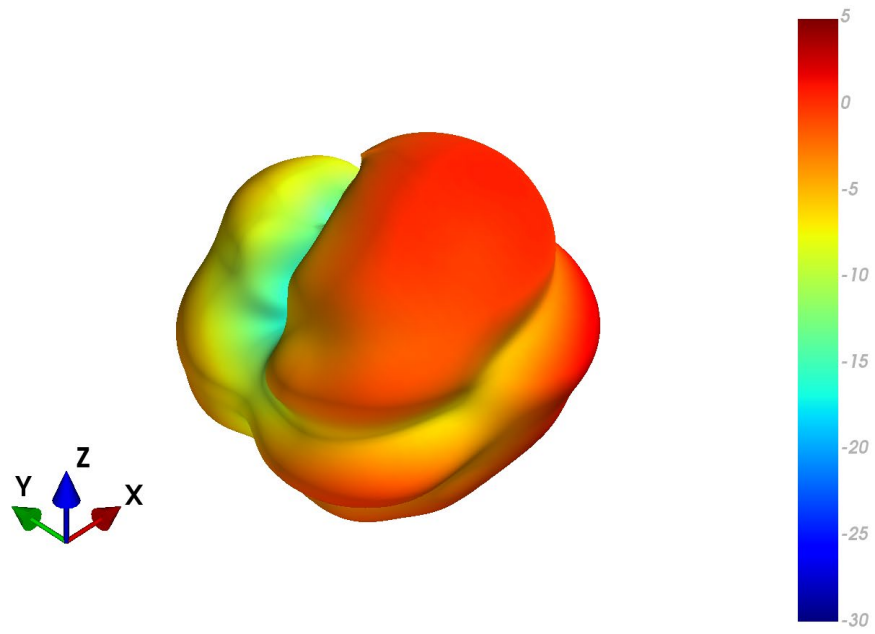

4.24 NA Patterns at 1710 MHz

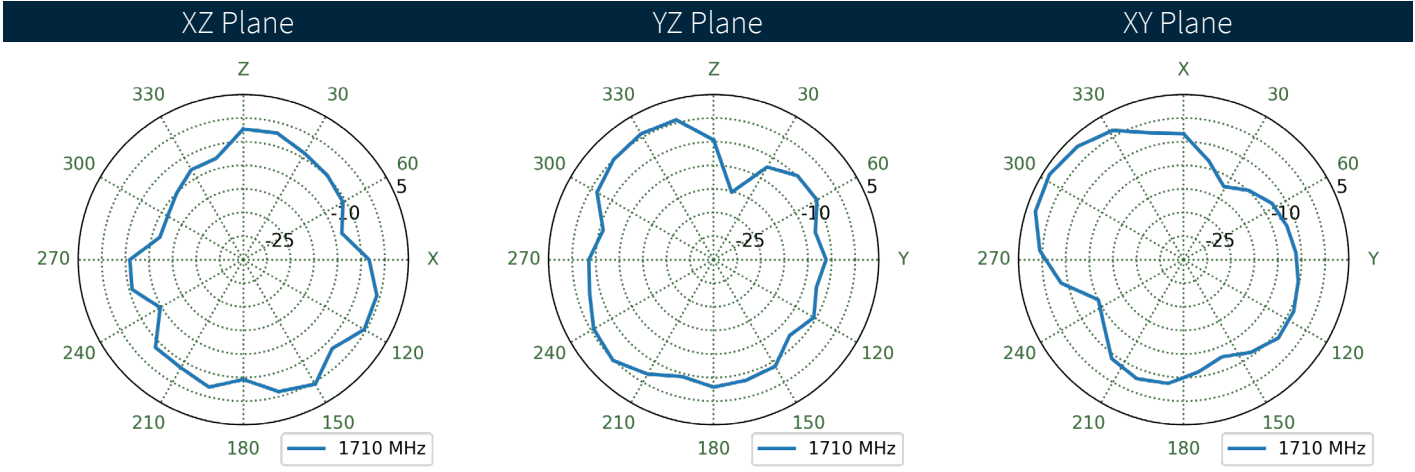
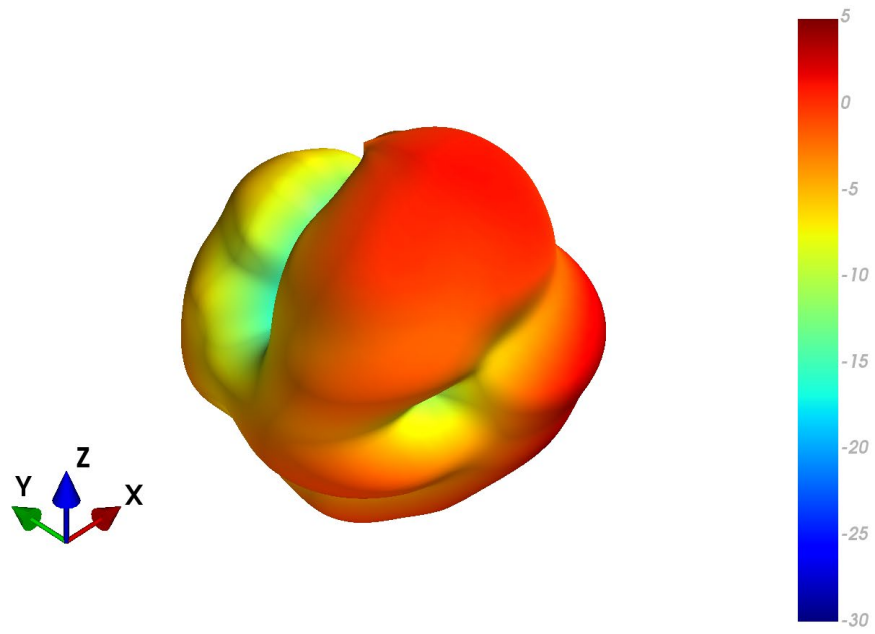

4.25 WW Patterns at 1710 MHz

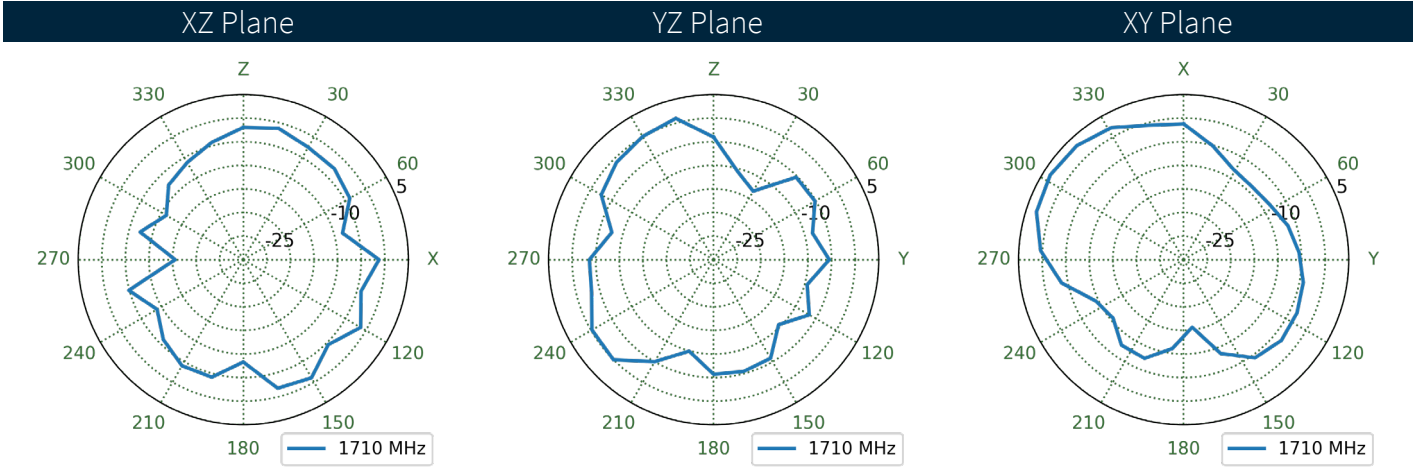
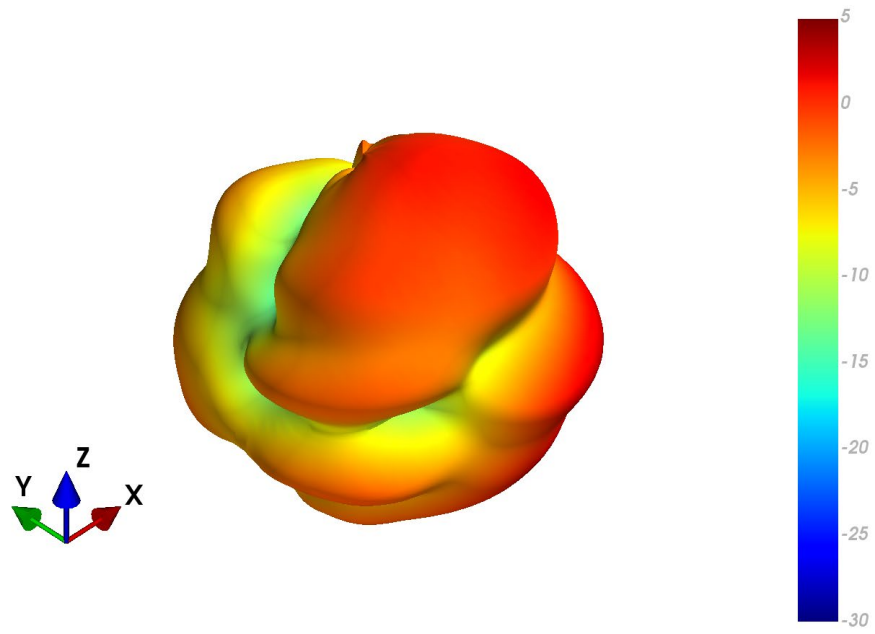

4.26 EMEA Patterns at 1850 MHz

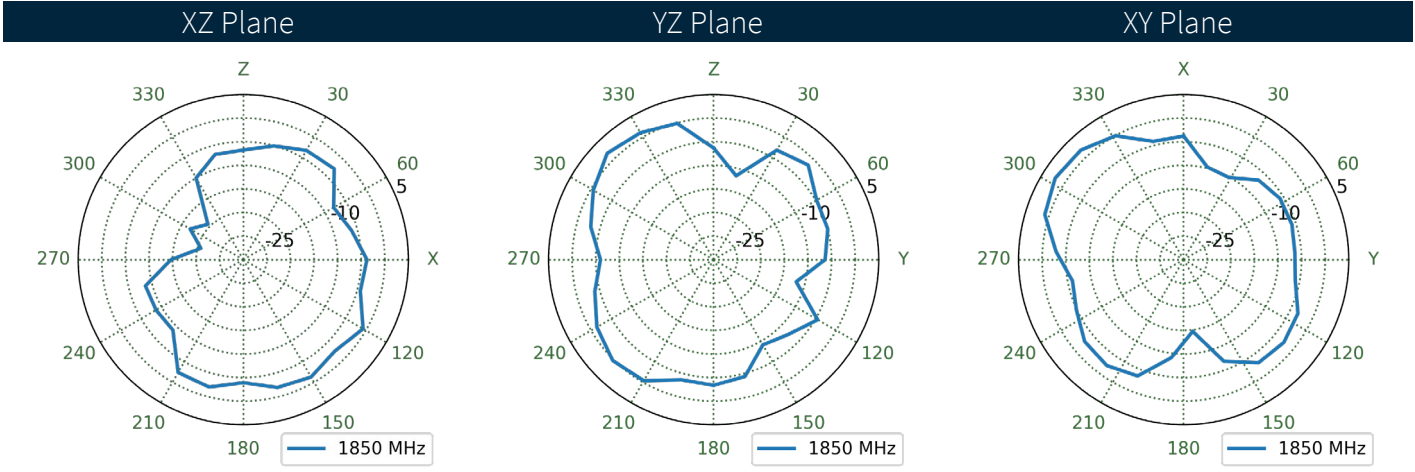
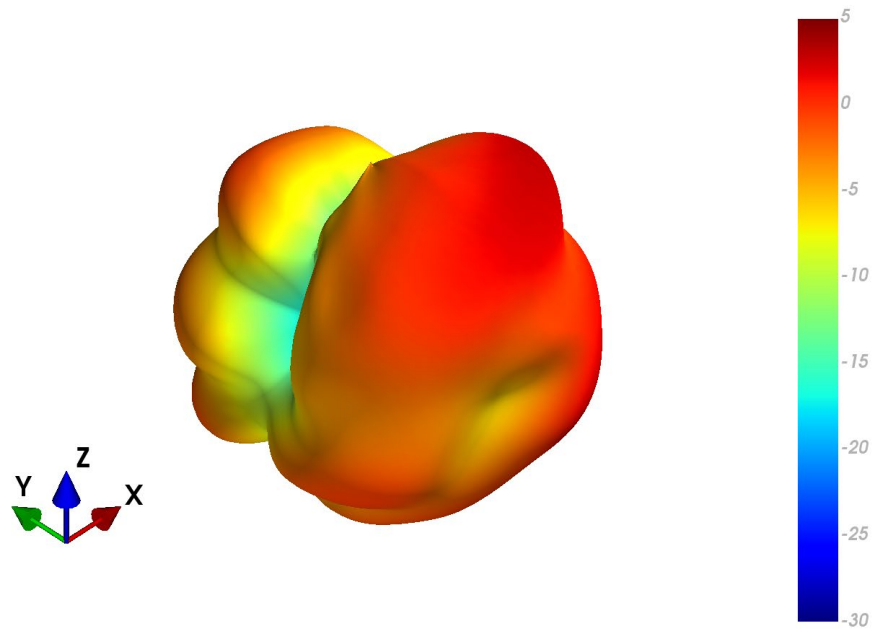

4.27 NA Patterns at 1850 MHz

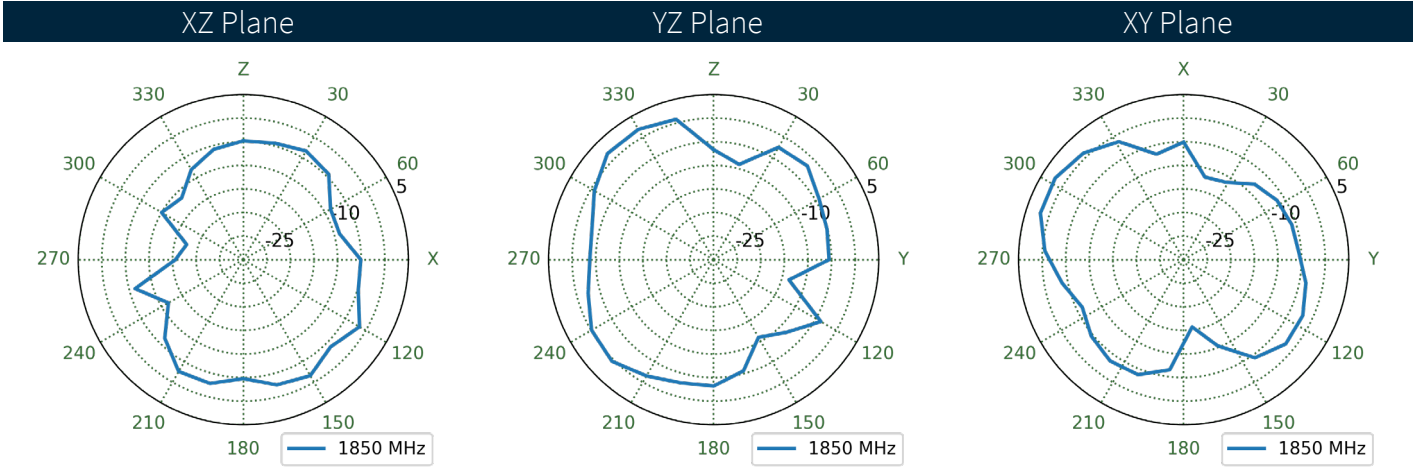
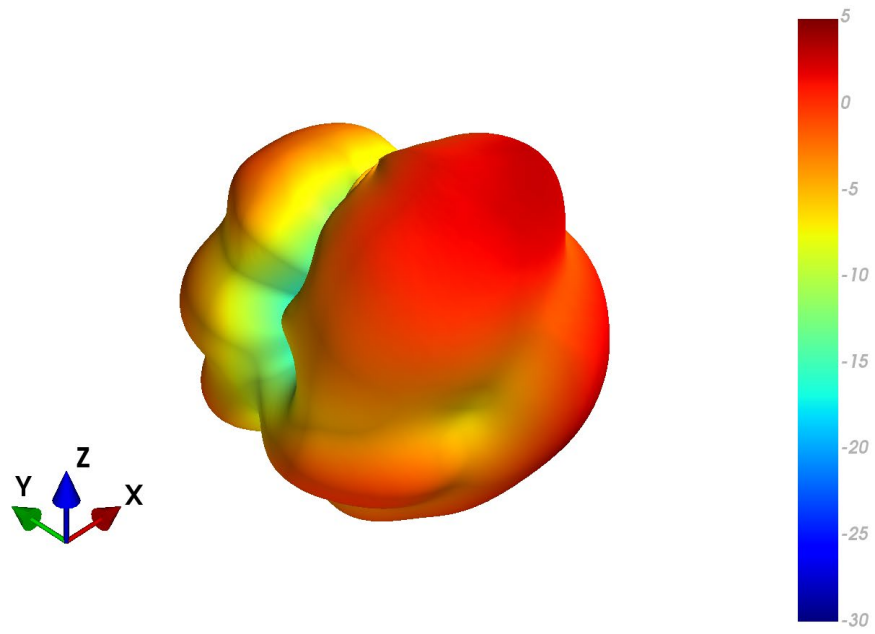

4.28 WW Patterns at 1850 MHz

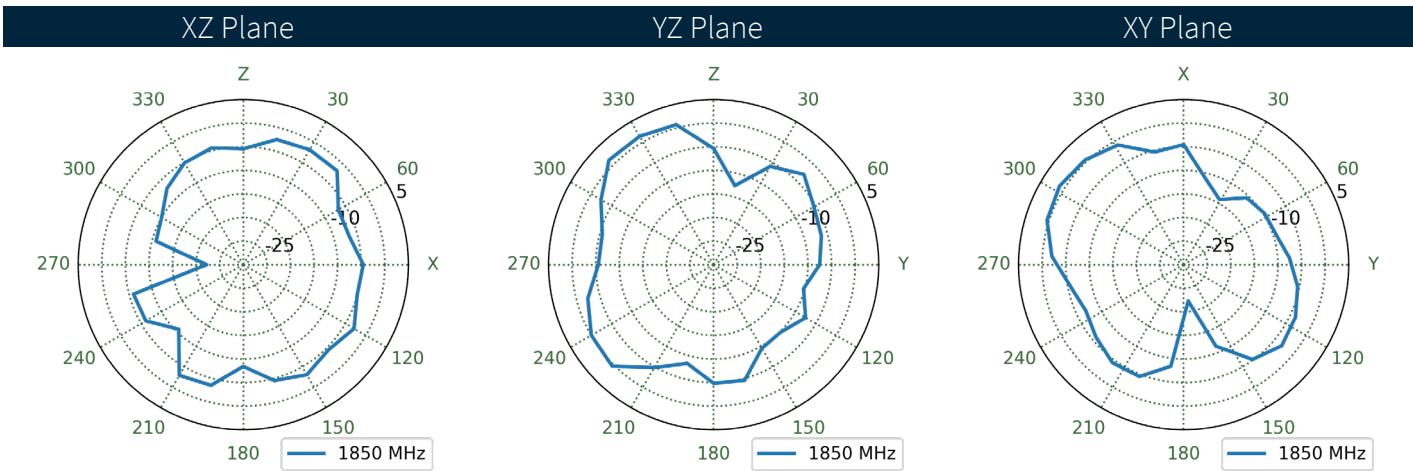
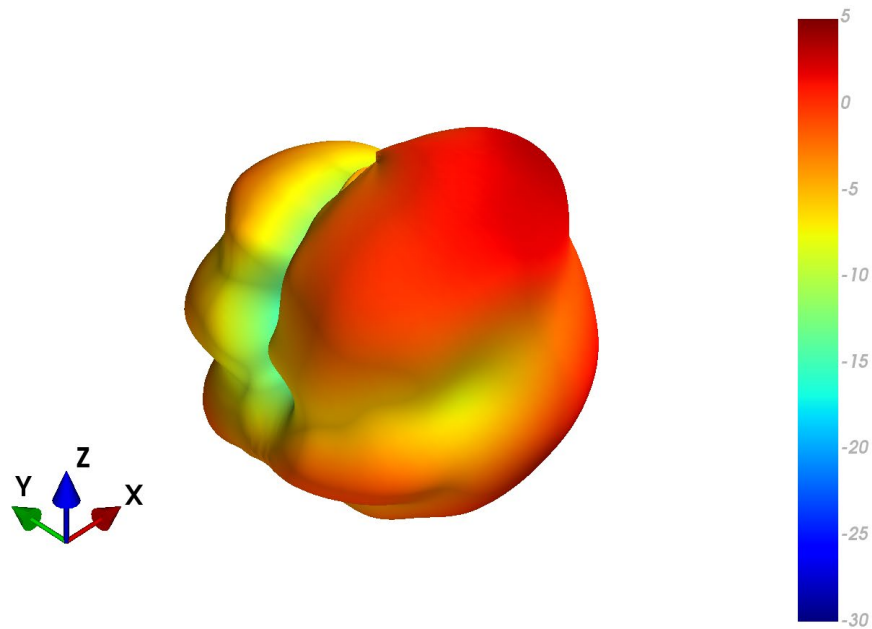

4.29 EMEA Patterns at 1910 MHz

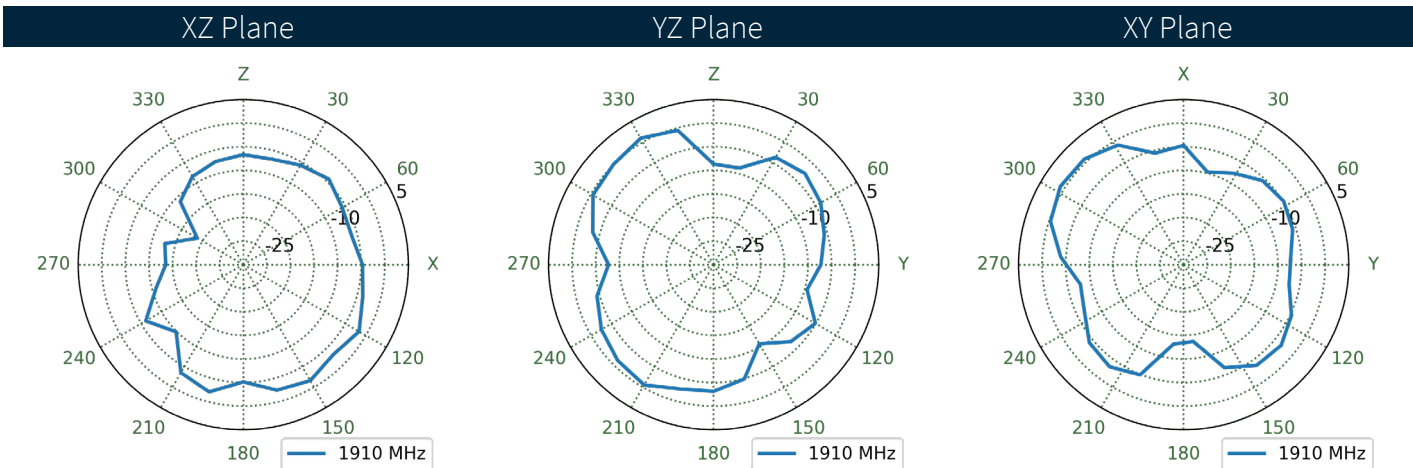
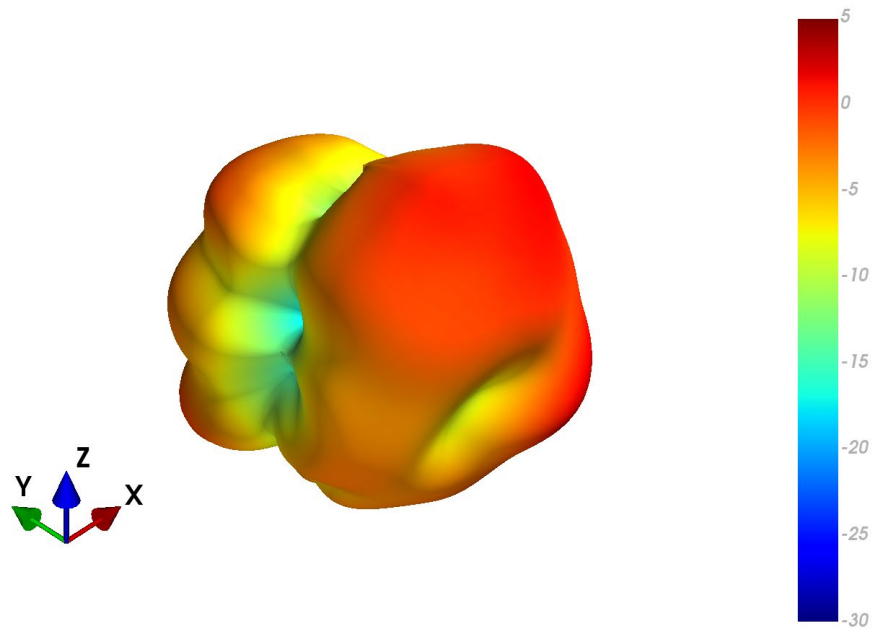

4.30 NA Patterns at 1910 MHz

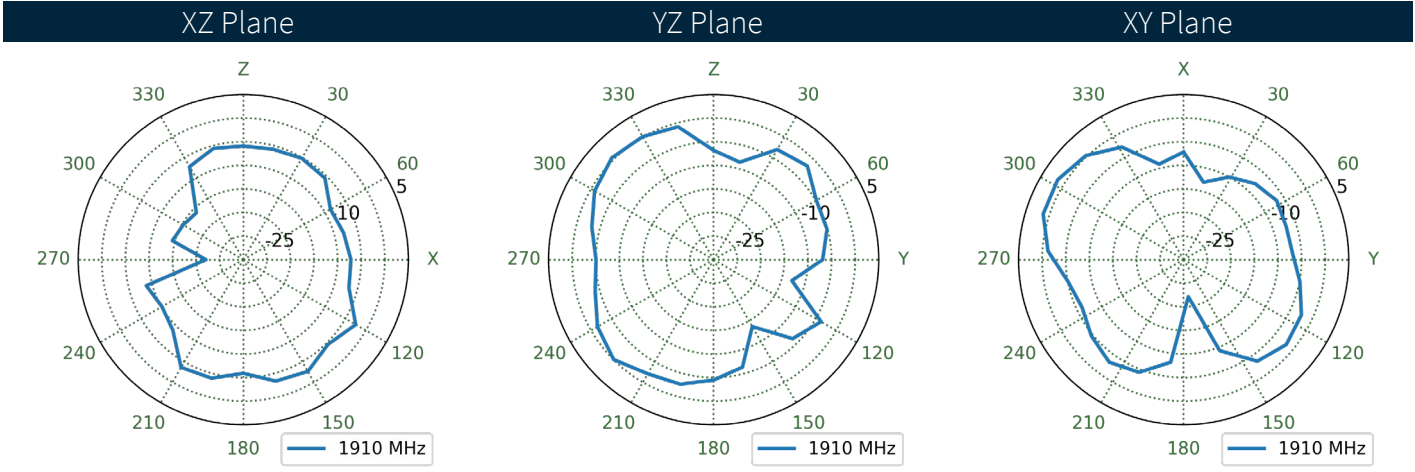
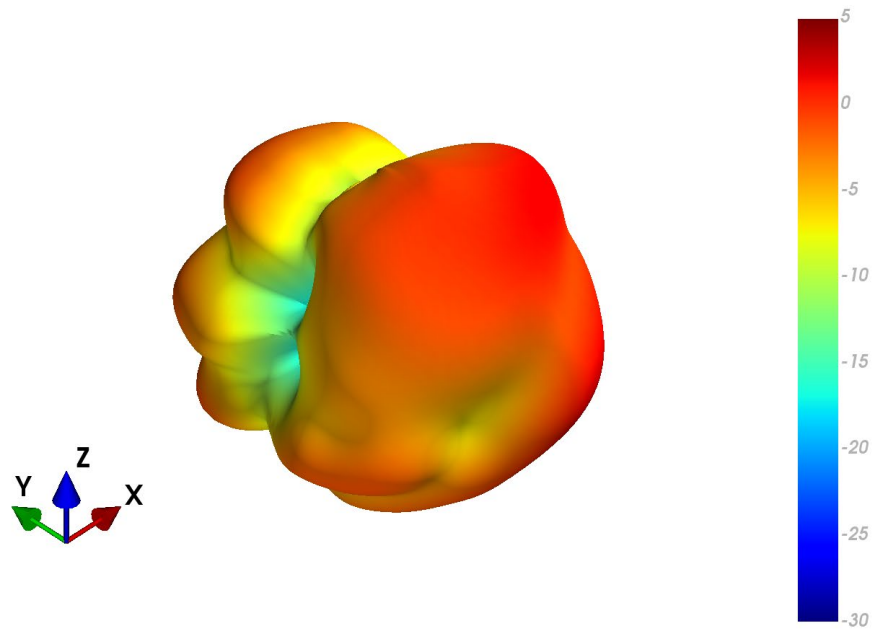

4.31 WW Patterns at 1910 MHz

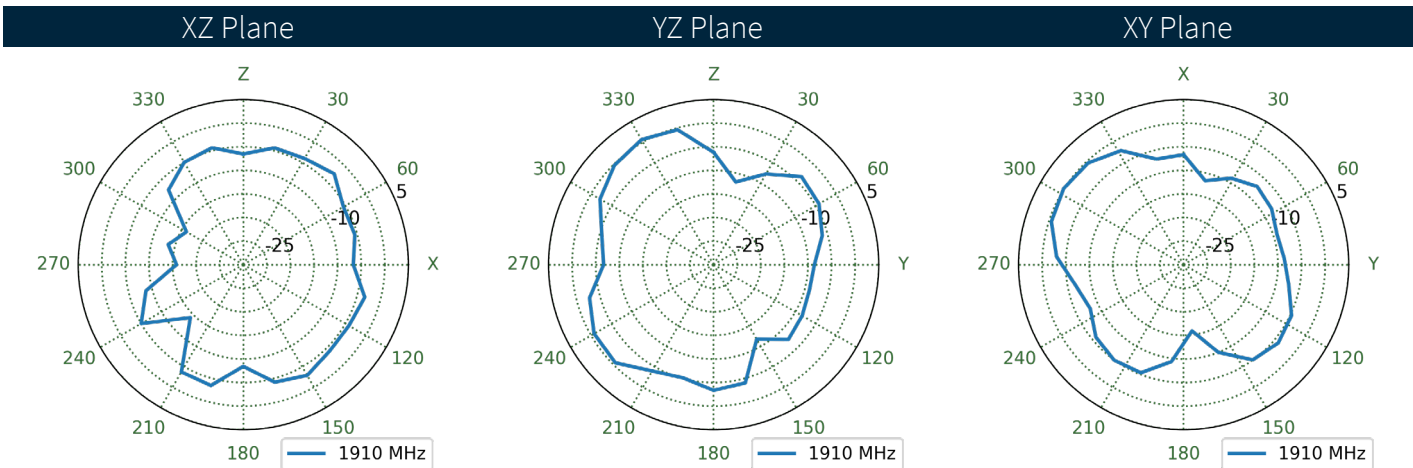
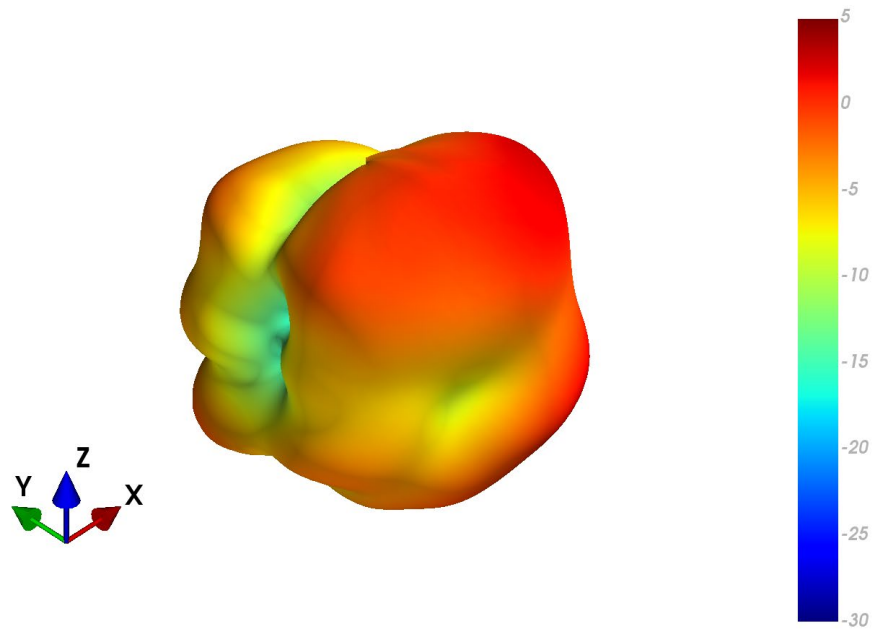

4.32 EMEA Patterns at 2155 MHz

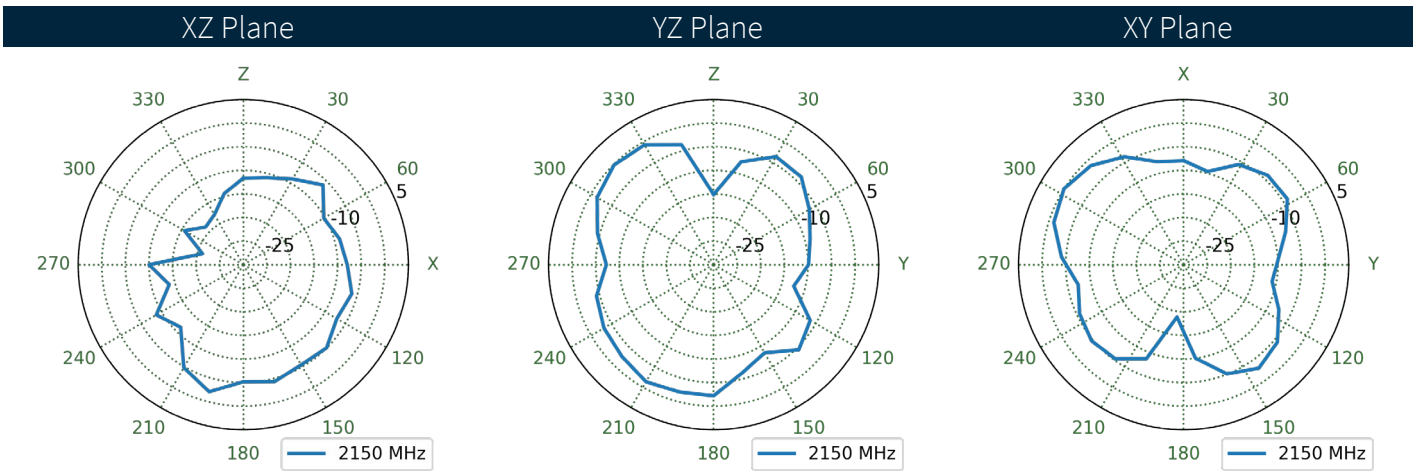
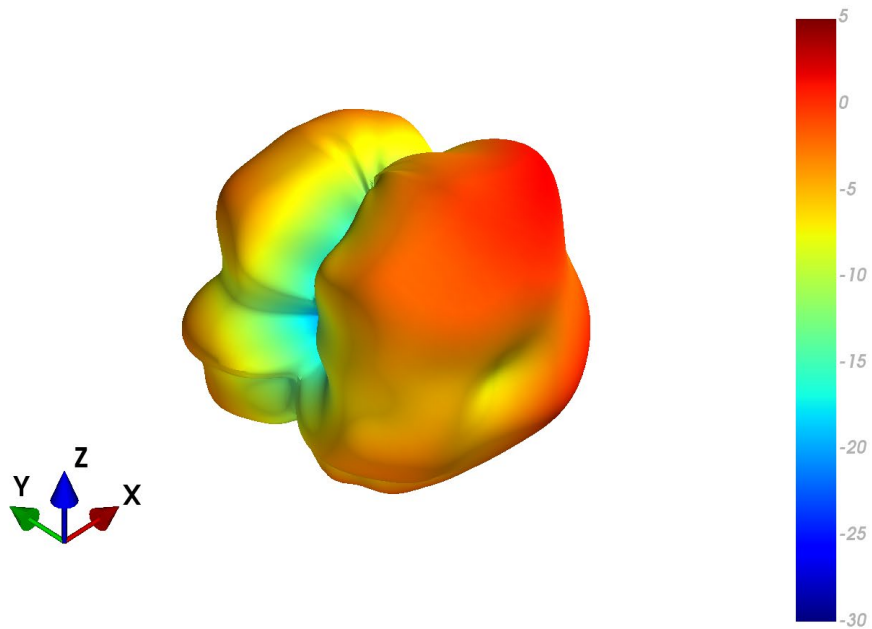

4.33 NA Patterns at 2155 MHz

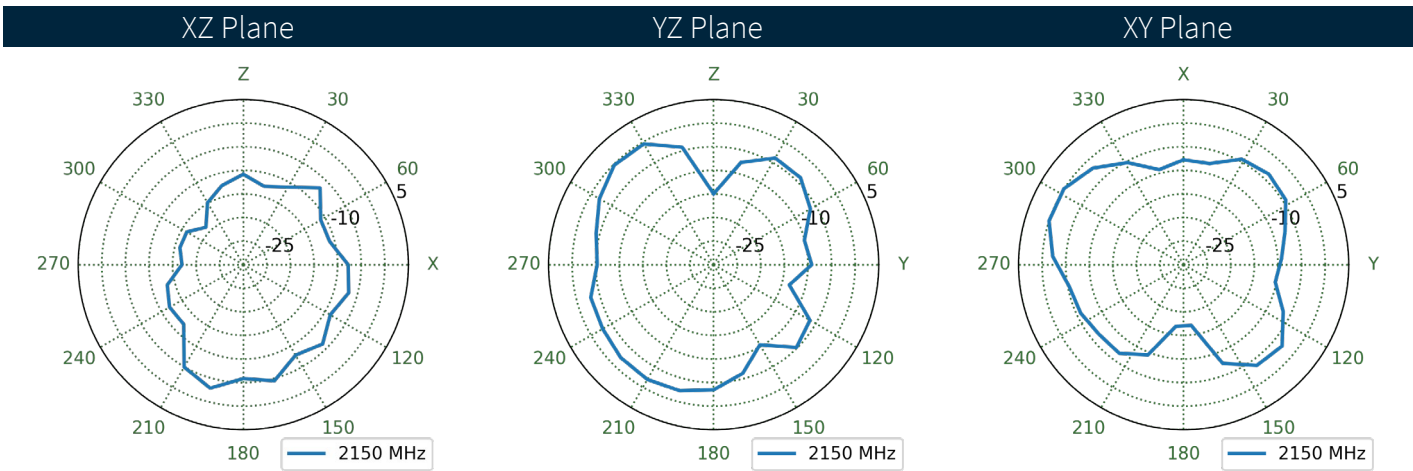
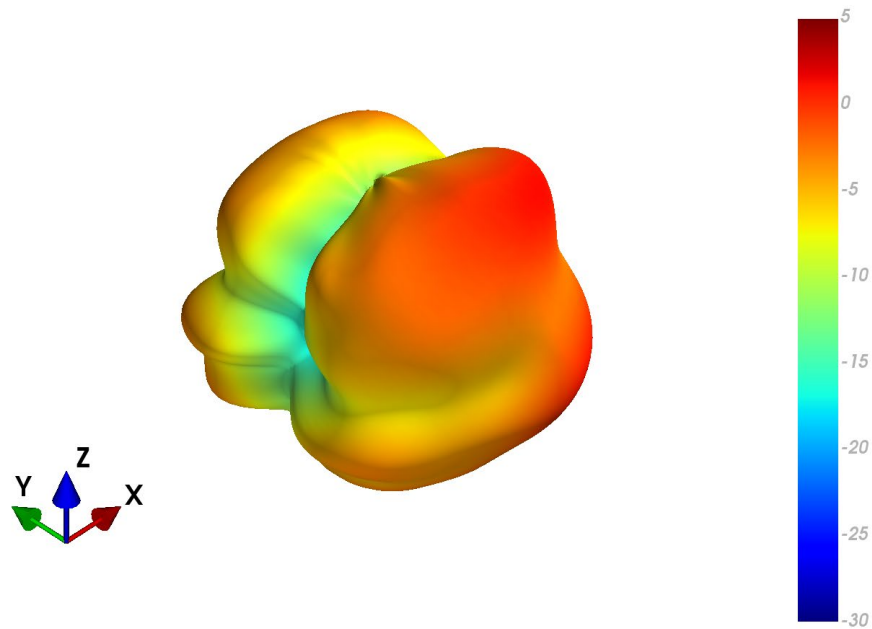

4.34 WW Patterns at 2155 MHz

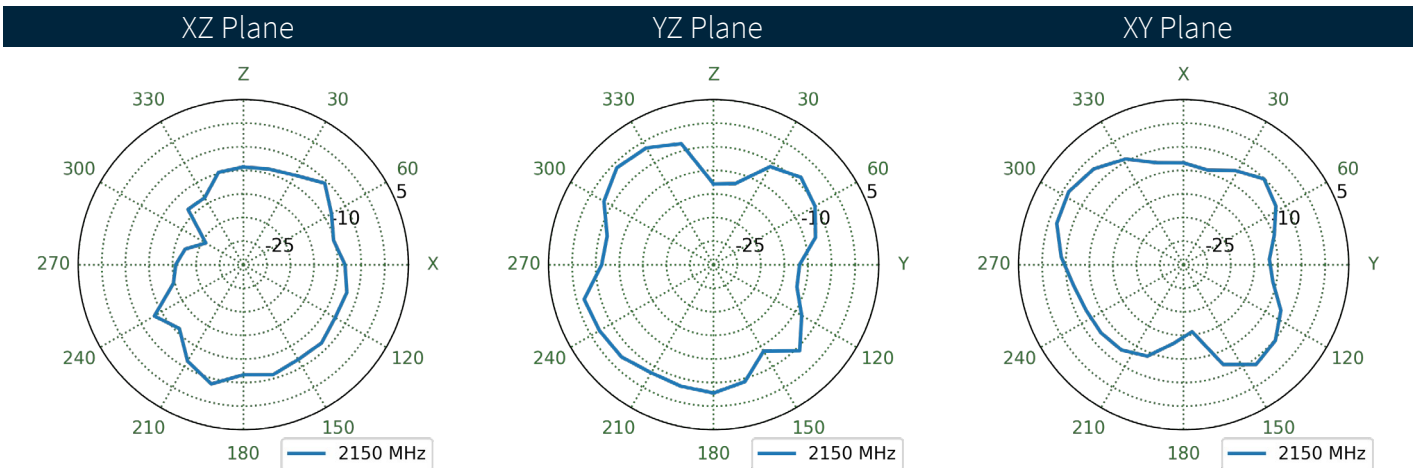
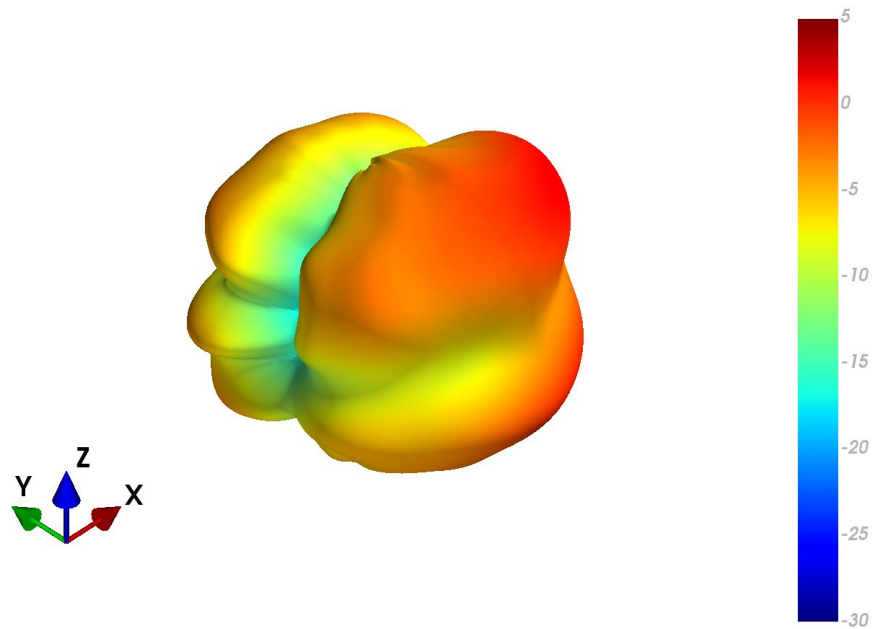

4.35 EMEA Patterns at 2700 MHz

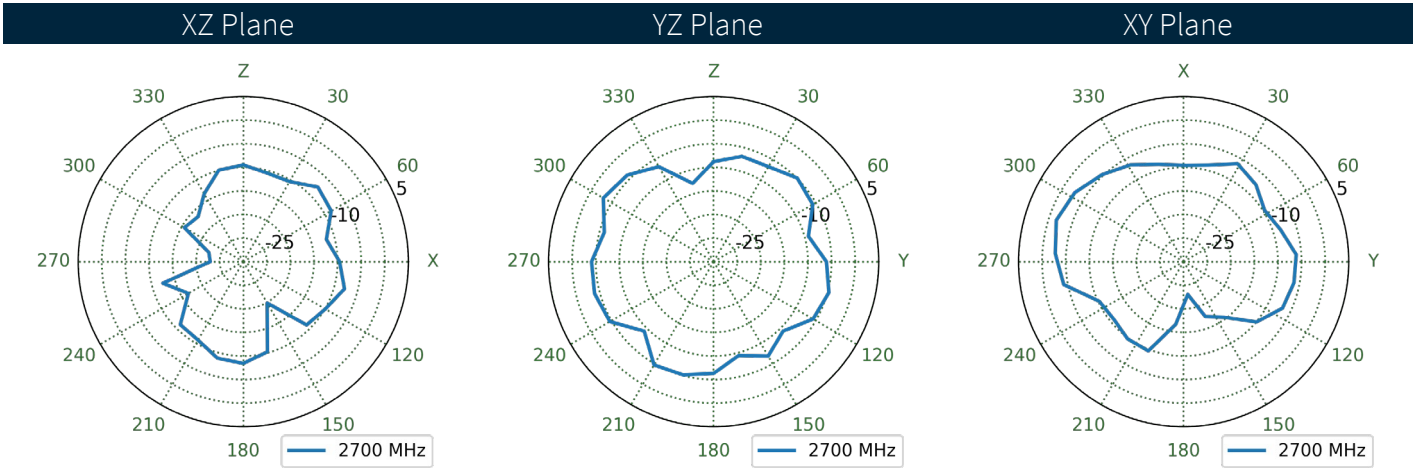
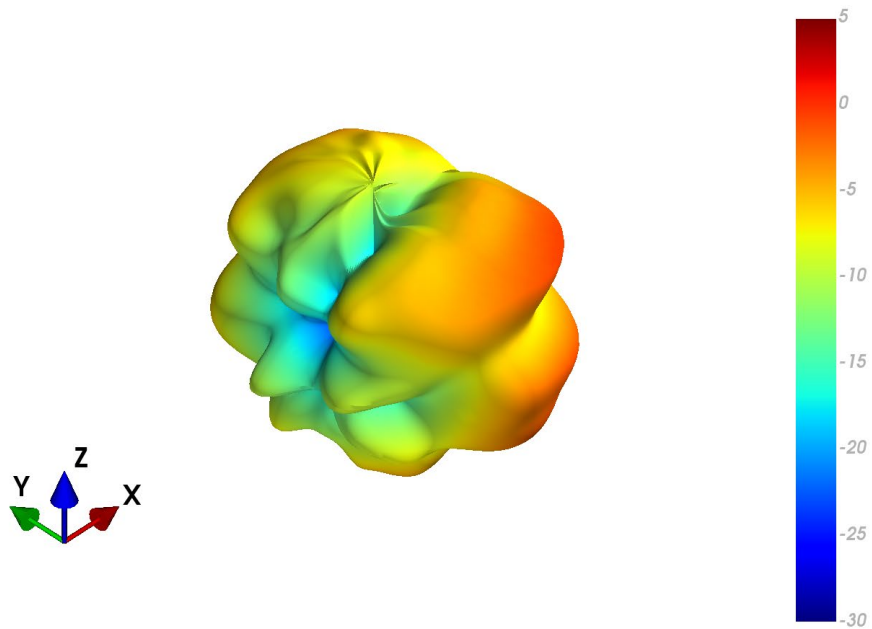

4.36 NA Patterns at 2700 MHz

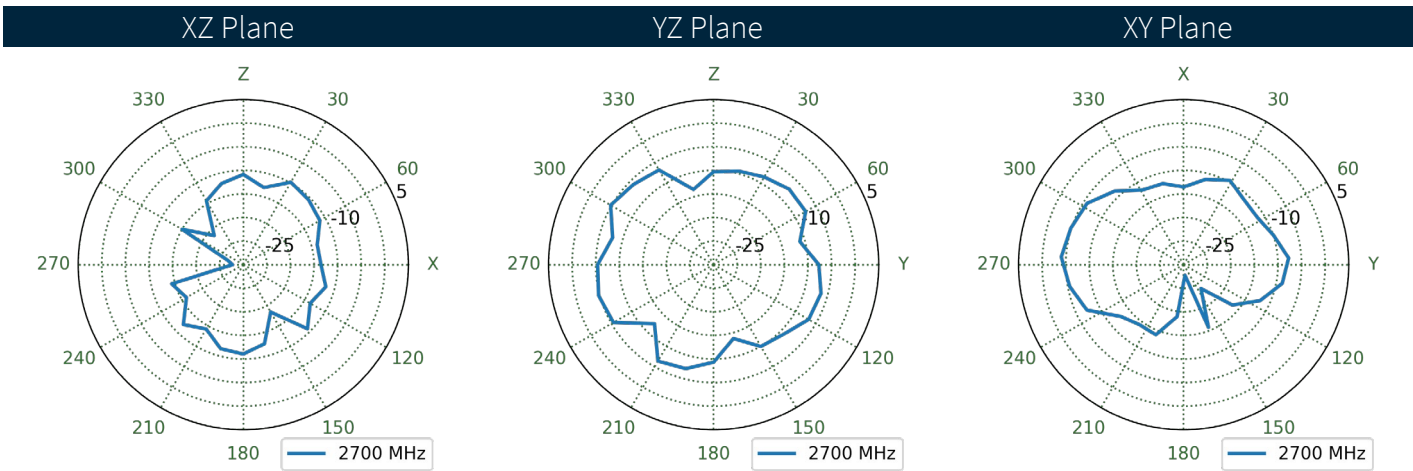
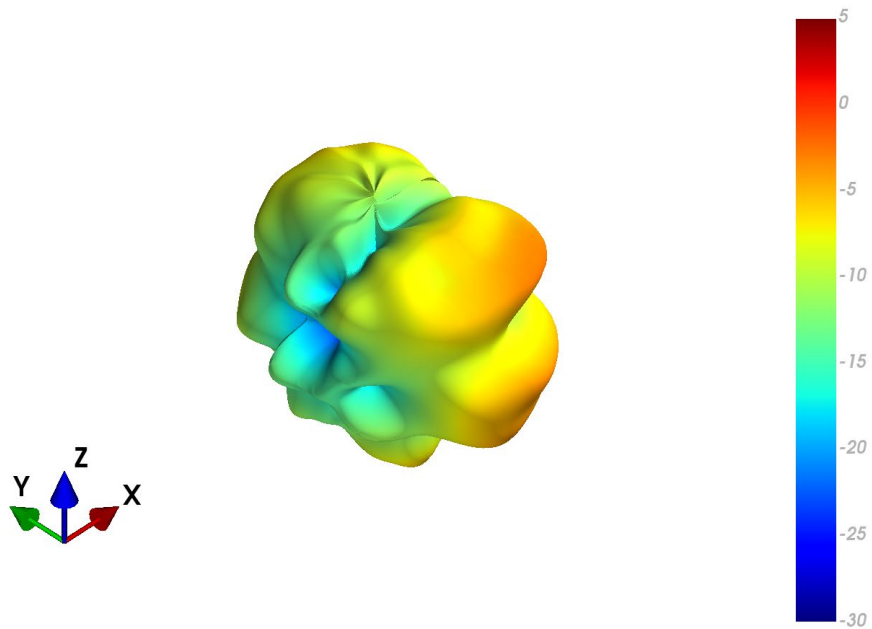

4.37 WW Patterns at 2700 MHz

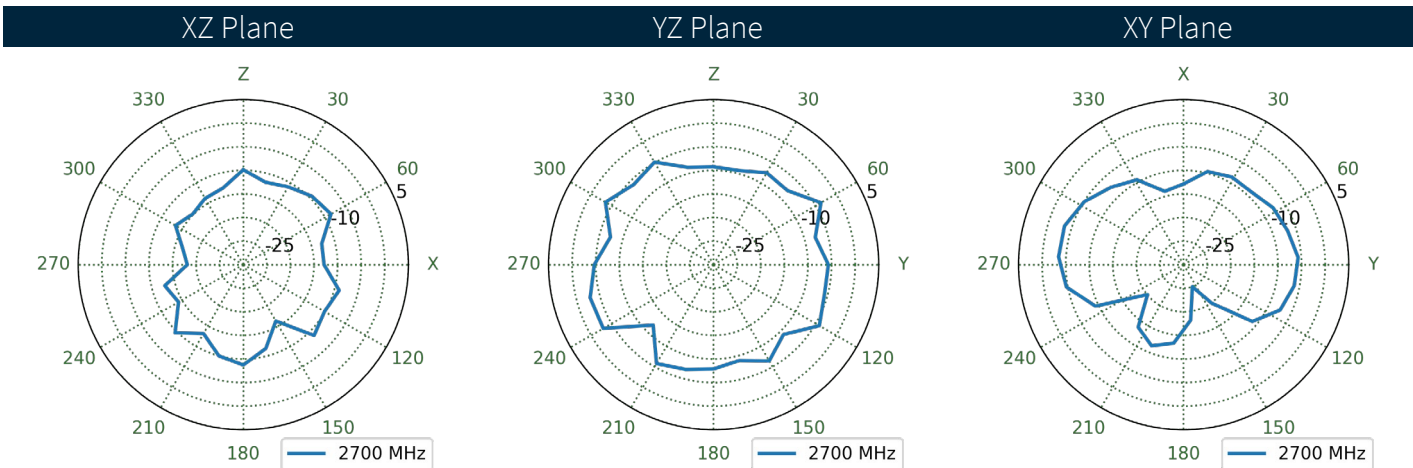
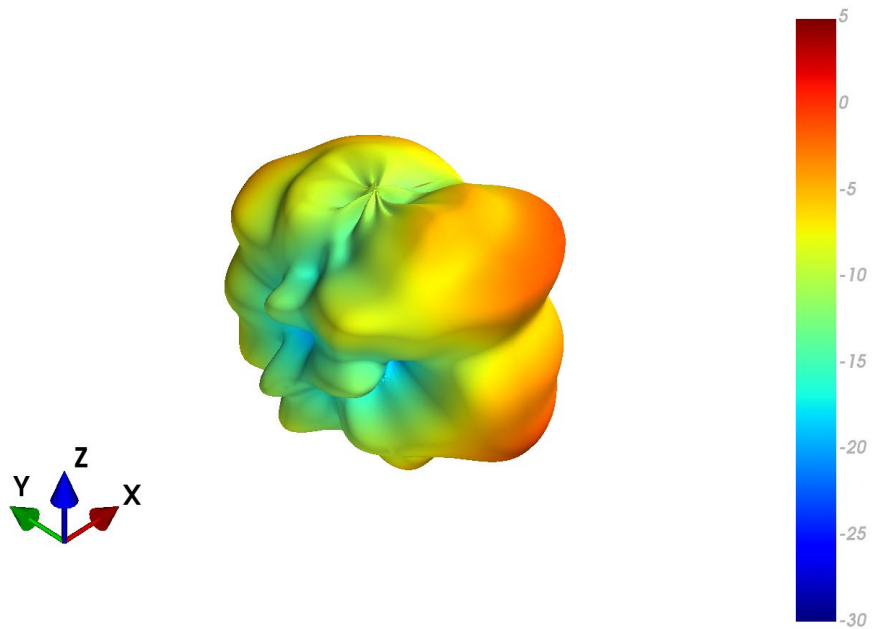

5. Mechanical Drawing

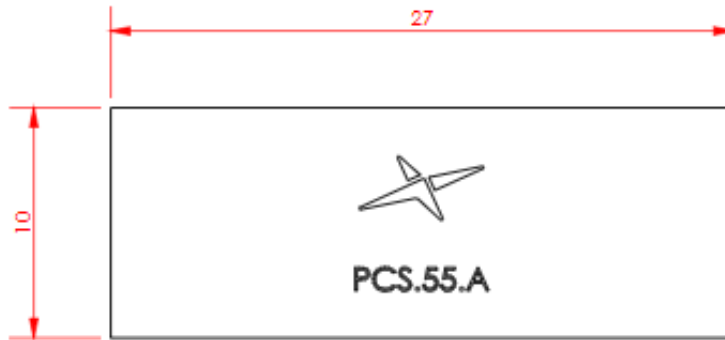

TOP VIEW

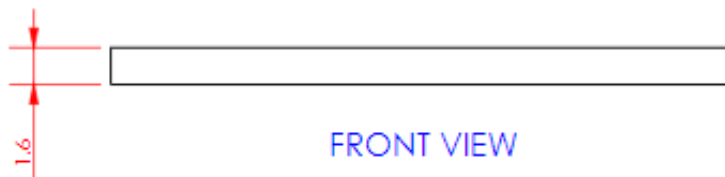

FRONT VIEW

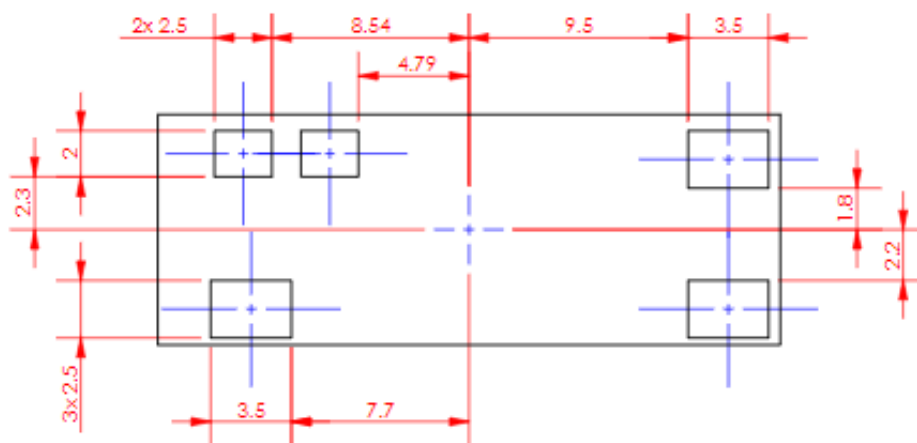

BOTTOM VIEW

6. Packaging

1000 pc PCS.55.A per reel
 Dimensions – Ø330*60
 Weight – 1630g

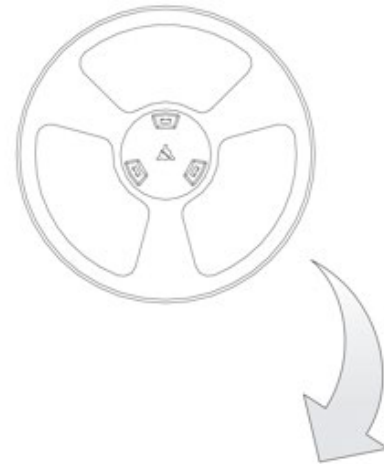

1000 pc PCS.55.A / 1 reel in small box
 Dimensions – Ø335*335*85mm
 Weight – 1.9Kg

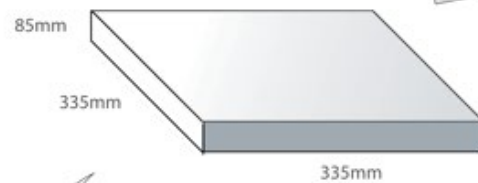

3 reels, 3000 pcs in one carton
 Carton dimensions – 370*360*275mm
 Weight – 6.5Kg

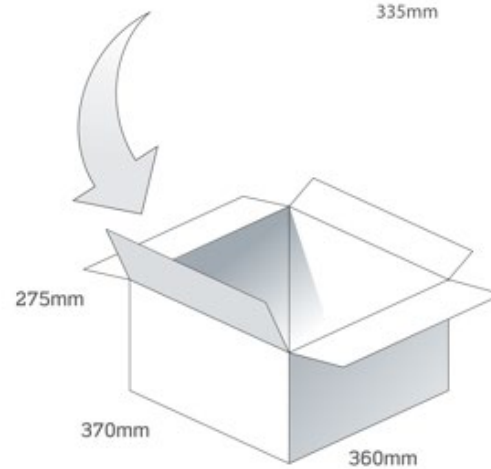

7. Antenna Integration Guide

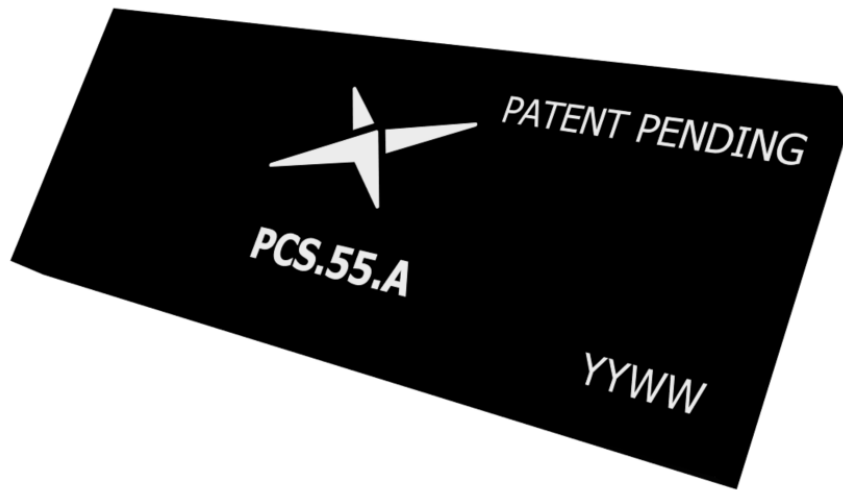

7.1 Schematic and Symbol Definition

The circuit symbol for the antenna is shown below. The antenna has 5 pins with only two pins (Pin 1 and Pin 2) as functional. Pins 3, 4 and 5 are for mechanical strength.

Pin	Description
1	RF Feed
2	Ground
3, 4, 5	Mechanical, Not Connected

PCS.55.A
ANT1

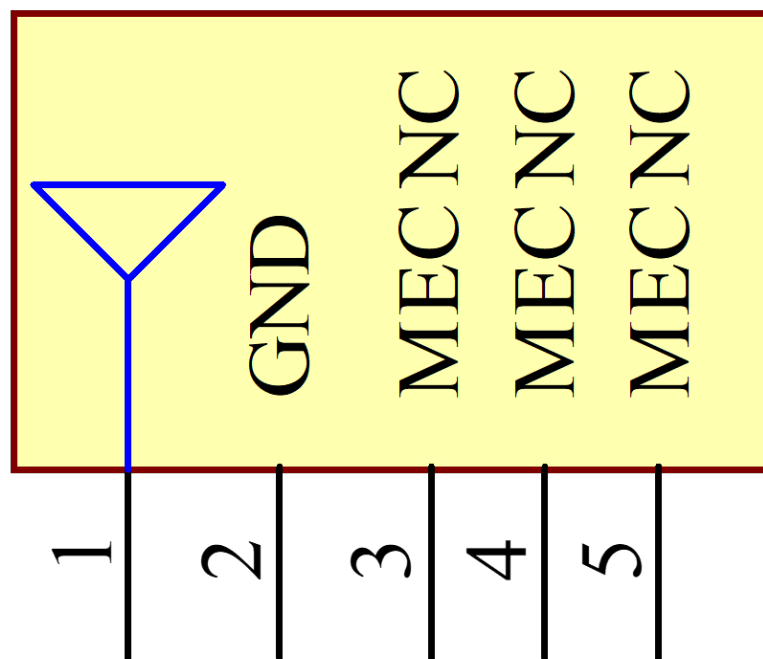

7.2 Antenna Integration

For any given PCB size, the antenna should ideally be placed on the PCB's shortest side, to take advantage of the ground plane. Optimized matching components can be placed as shown.

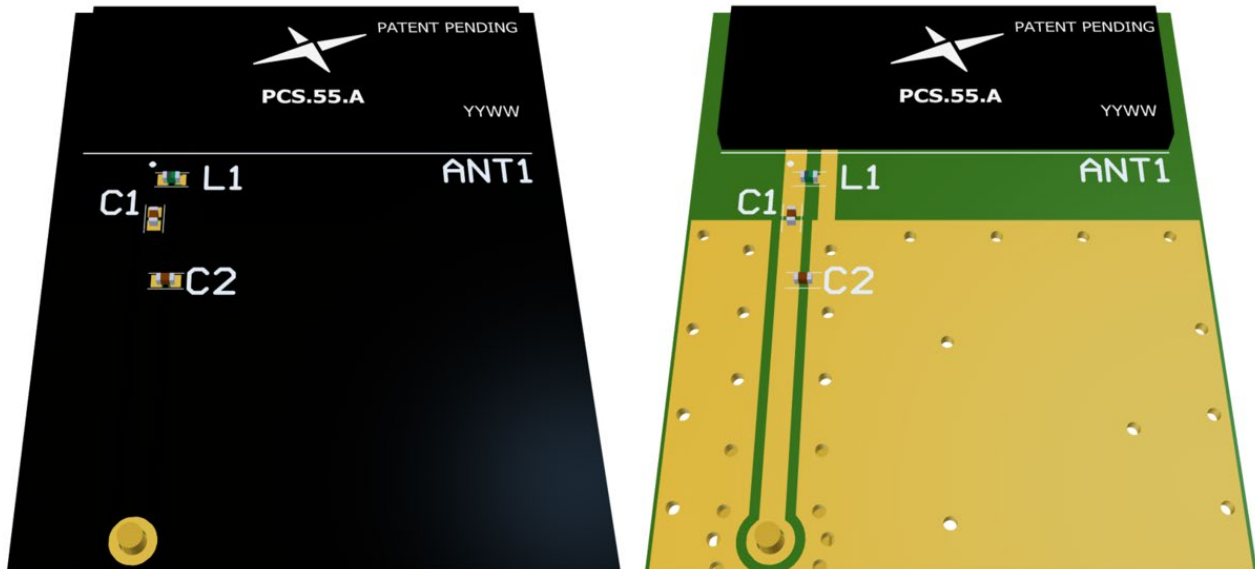

7.3 PCB Layout - NA

The footprint and clearance on the PCB must meet the layout drawing in section (7.12). Note the placement of the optimized components. L1 is placed as close as possible to the RF feed (pad 1) within the copper keep out area. C1 is then placed tightly in series with C2 placed in parallel after that.

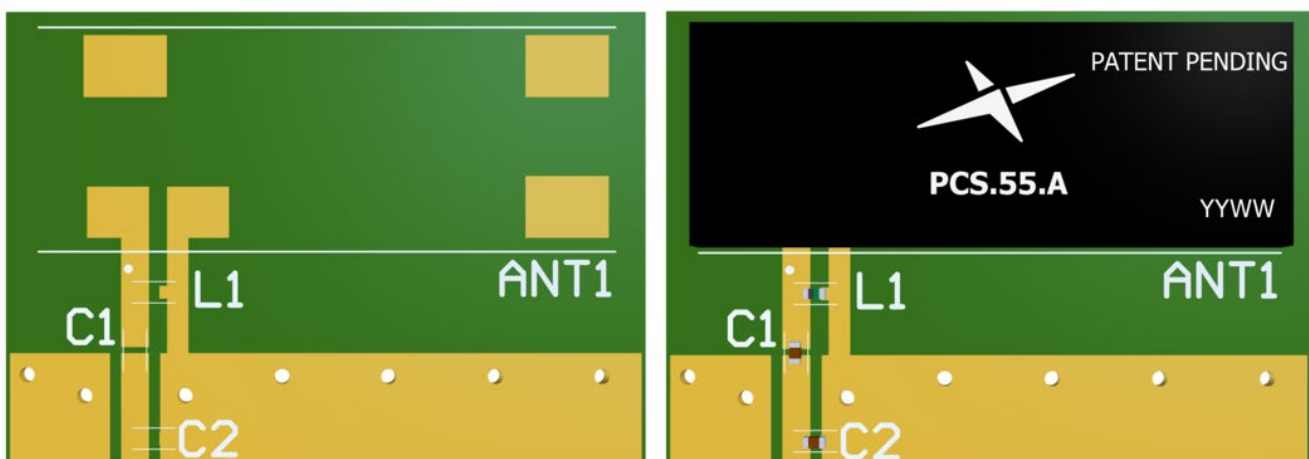

7.4 PCB Layout - EMEA

The footprint and clearance on the PCB must meet the layout drawing in section (7.12). Note the placement of the optimized components. C1 is placed as close as possible to the RF feed (pad 1) across the copper keep out area. L1 is then placed tightly in parallel with C2 placed in series after that.

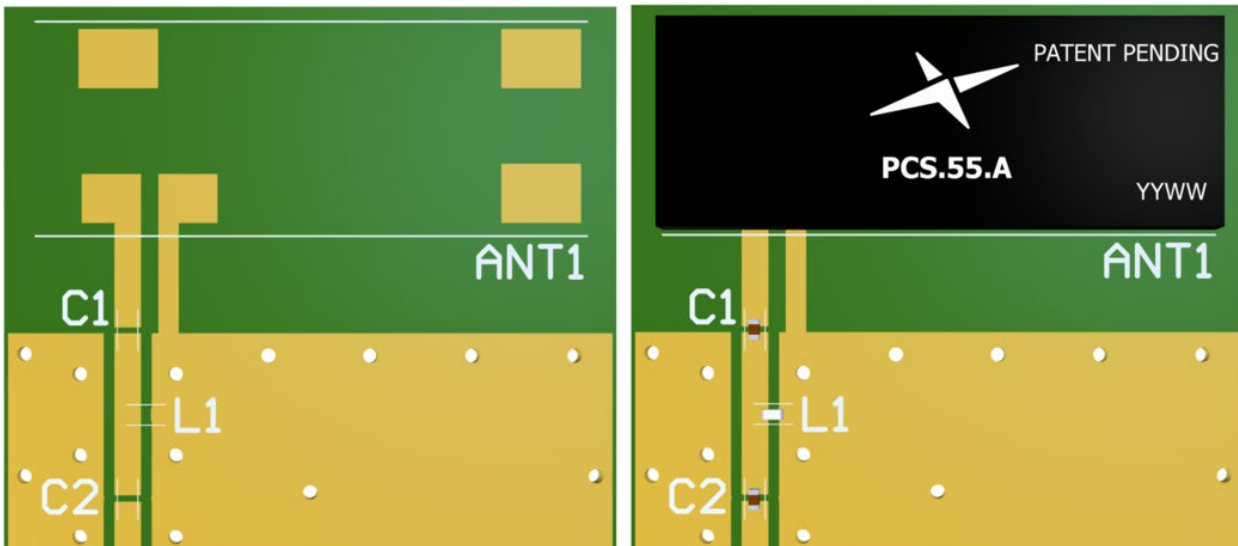

7.5 PCB Layout - WW

The footprint and clearance on the PCB must meet the layout drawing in section (7.12). Note the placement of the optimized components. L1 is placed as close as possible to the RF feed (pad 1) within the copper keep out area. C1 is then placed tightly in series with L2 placed in parallel after that.

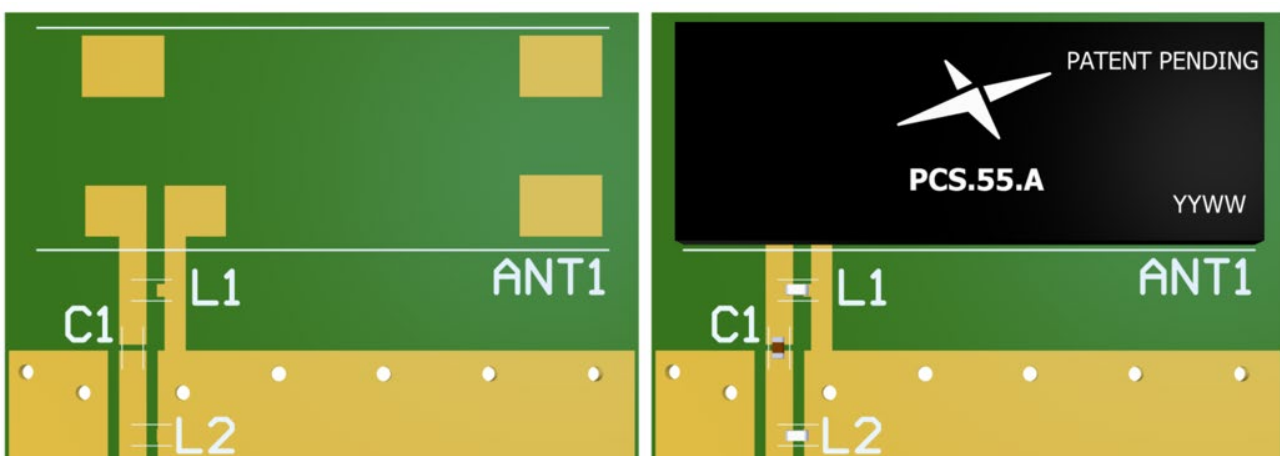

7.6 PCB Clearance

Below shows the antenna footprint and clearance through ALL layers on the PCB. Only the antenna pads and connections to feed and GND are present within this clearance area (marked RED). The clearance area extends to 5.4mm from the antenna pads to the ground area. This clearance area includes the bottom side and ALL internal layers on the PCB.

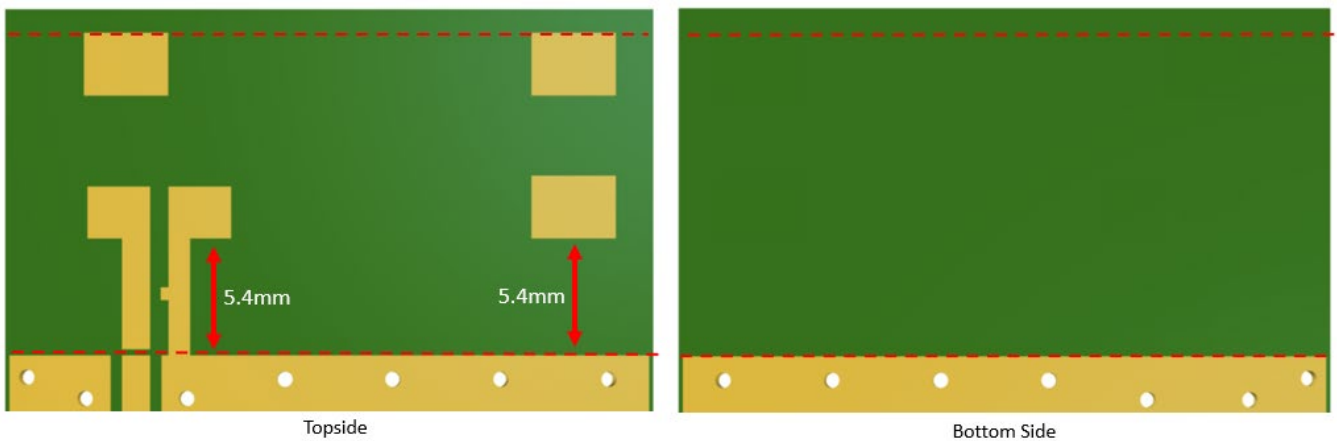

7.7 Evaluation Board

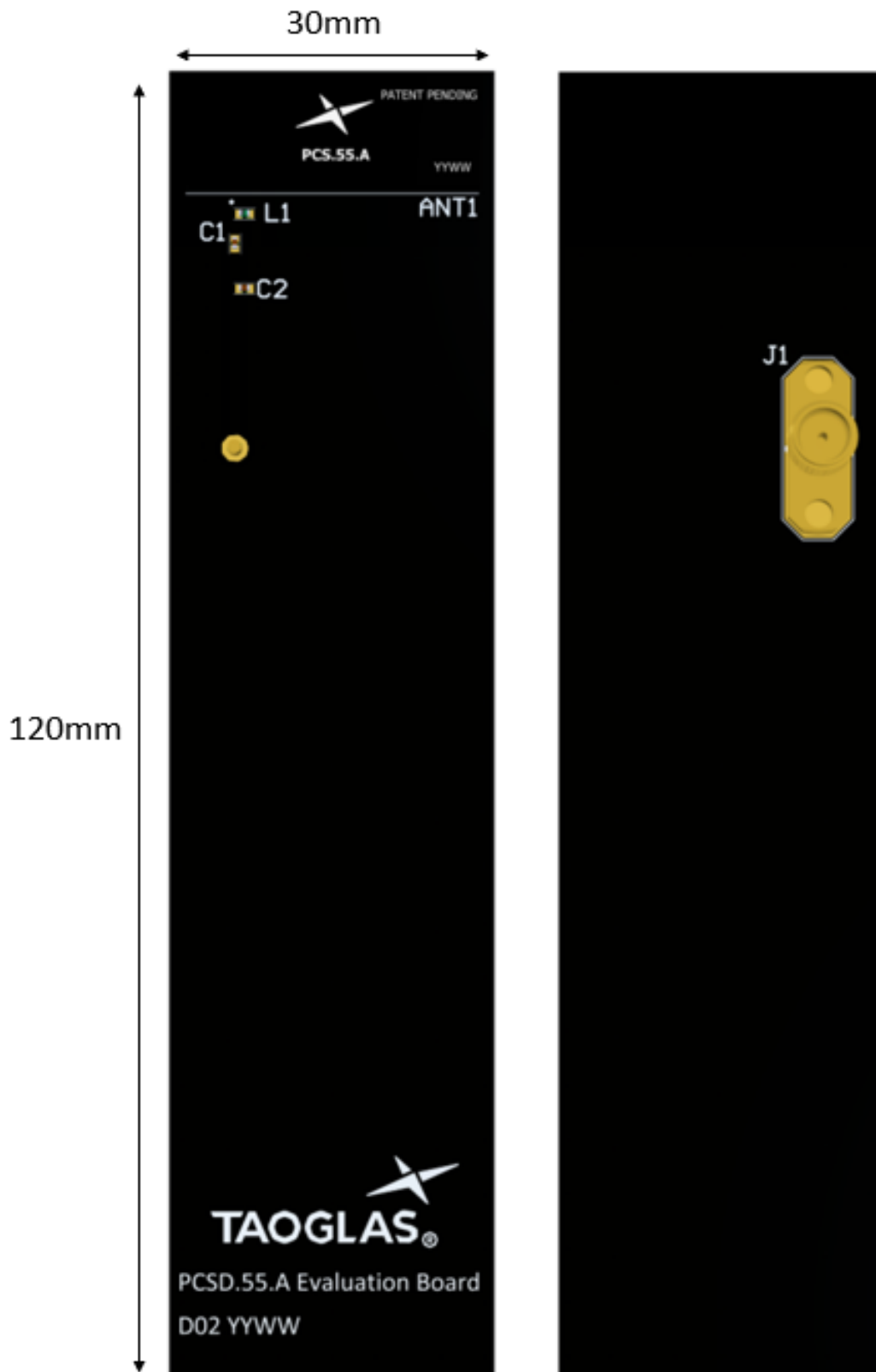

7.8 Evaluation Board Ground Plane Length

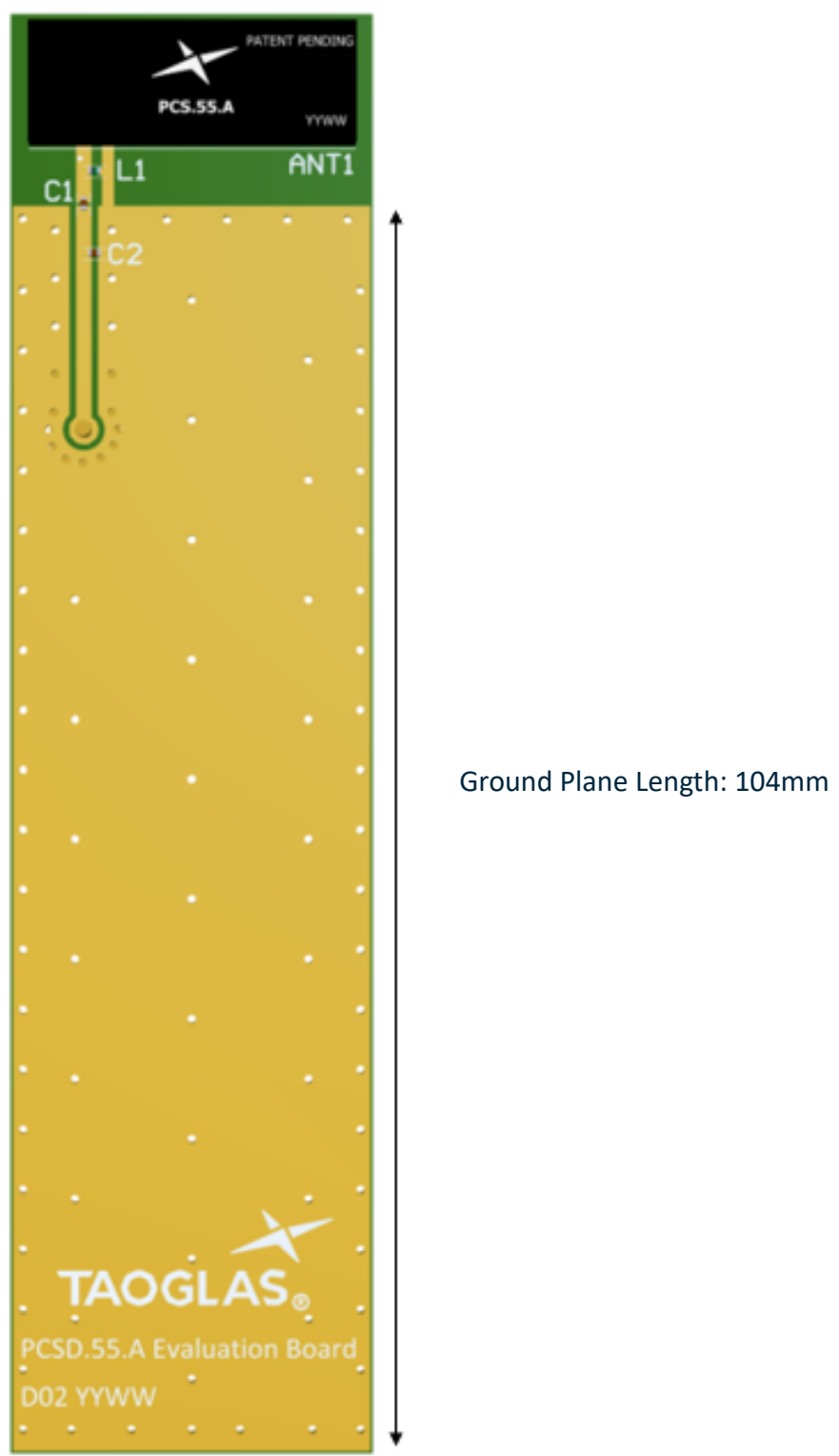

7.9 Matching Circuit - NA

Matching components with the PCS.55.A are recommended for the antenna to have optimal performance on the evaluation board, located in the spaces specified in the above images. Additional matching components may be necessary for your device, so we recommend incorporating extra component footprints, forming a “pi” network, between the cellular module and the edge of the ground plane.

Designator	Type	Value	Manufacturer	Manufacturer Part Number
L1	Inductor	8.2nH	Murata	LQG15HS8N2G02D
C1	Capacitor	2.7pF	Murata	GCM1555C1H2R7BA16D
C2	Capacitor	0.5pF	Murata	GRM1555C1HR50CA01D

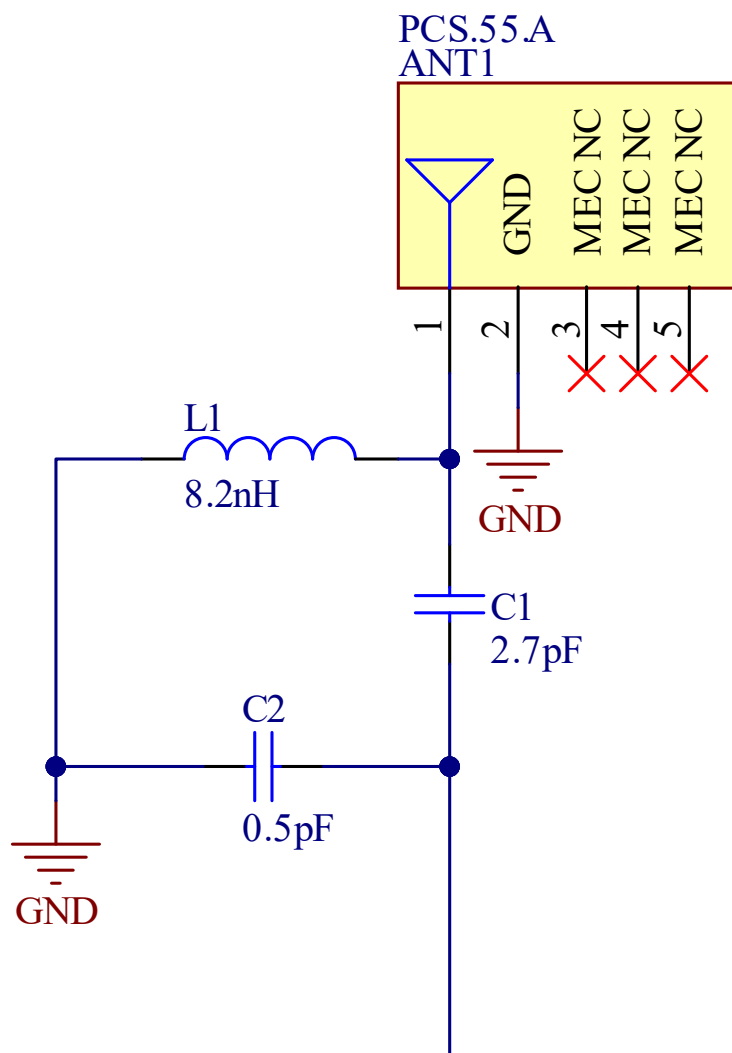

7.10 Matching Circuit - EMEA

Matching components with the PCS.55.A are recommended for the antenna to have optimal performance on the evaluation board, located in the spaces specified in the above images. Additional matching components may be necessary for your device, so we recommend incorporating extra component footprints, forming a “pi” network, between the cellular module and the edge of the ground plane.

Designator	Type	Value	Manufacturer	Manufacturer Part Number
L1	Inductor	10nH	Murata	LQG15HS10NH02D
C1	Capacitor	4.3pF	Murata	GJM1555C1H4R3BB01D
C2	Capacitor	3.3pF	Murata	GJM1555C1H3R3BB01D

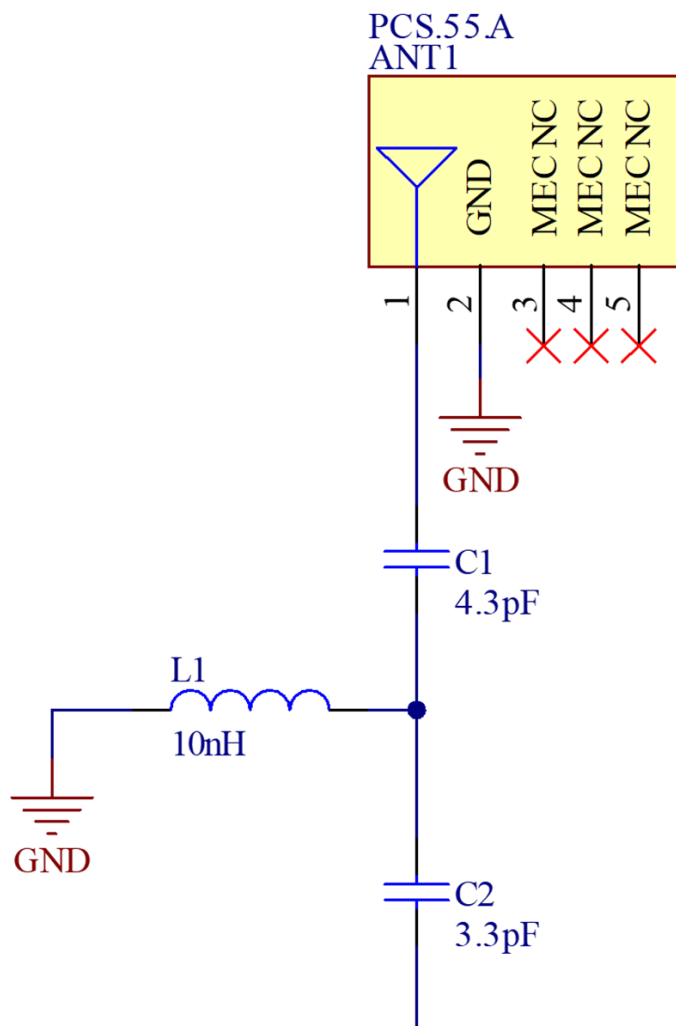

7.11 Matching Circuit - WW

Matching components with the PCS.55.A are recommended for the antenna to have optimal performance on the evaluation board, located in the spaces specified in the above images. Additional matching components may be necessary for your device, so we recommend incorporating extra component footprints, forming a “pi” network, between the cellular module and the edge of the ground plane.

Designator	Type	Value	Manufacturer	Manufacturer Part Number
L1	Inductor	10nH	Murata	LQG15HS10NH02D
L2	Inductor	15nH	Murata	LQG15HN15NG02D
C1	Capacitor	2.2pF	Murata	GRM1555C1H2R2CA01D

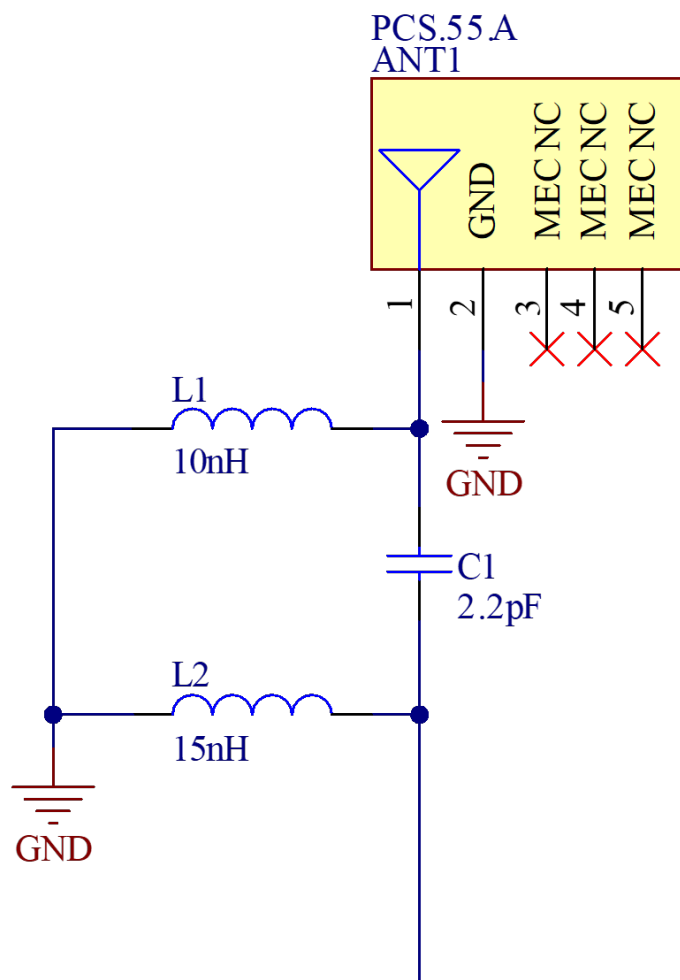

7.12 Footprint

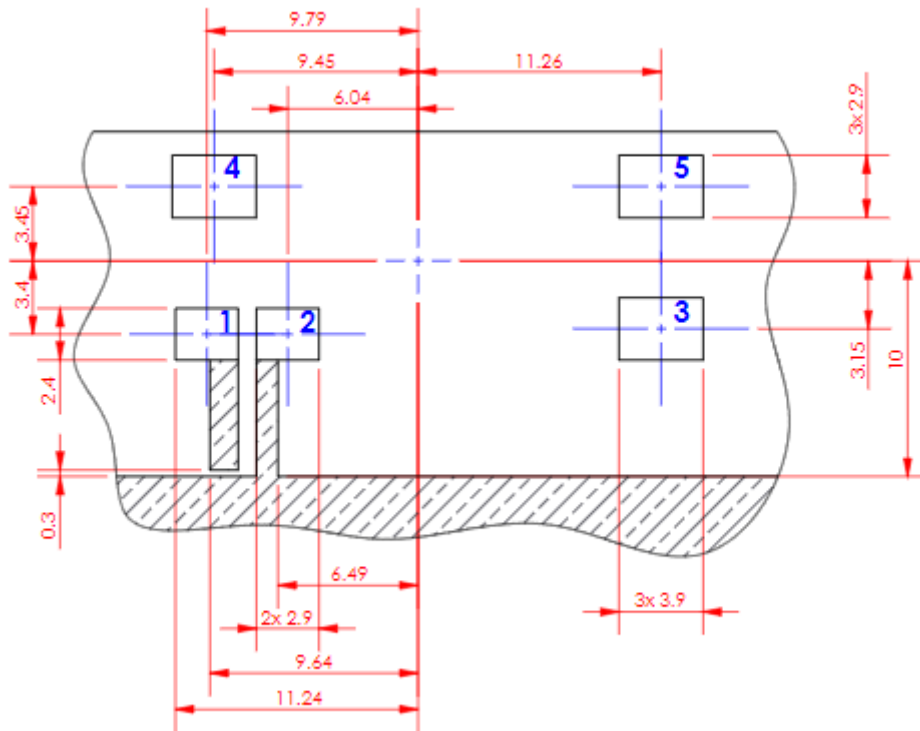

FOOT PRINT PCB

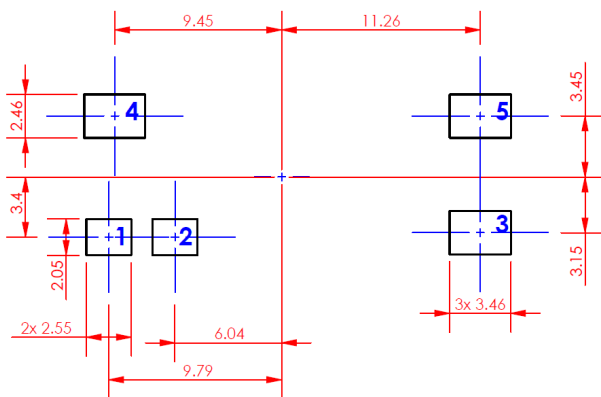

FOOTPRINT SOLDER PASTE

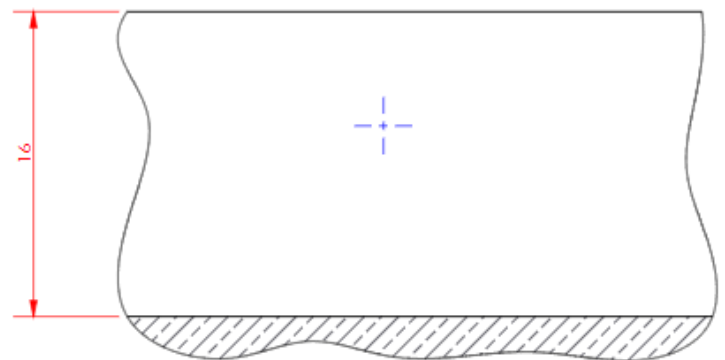

GROUND CLEARANCE BOTTOM VIEW

8. Application Note

The effect of shortening the ground plane on antenna performance was evaluated. Using the evaluation board of the PCS.55.A, the PCB was cut back 10mm at a time and tested in an anechoic chamber. The results for North America (NA), Europe, Middle East, Africa (EMEA), and Worldwide (WW) are shown here:

8.1 Efficiency – North America

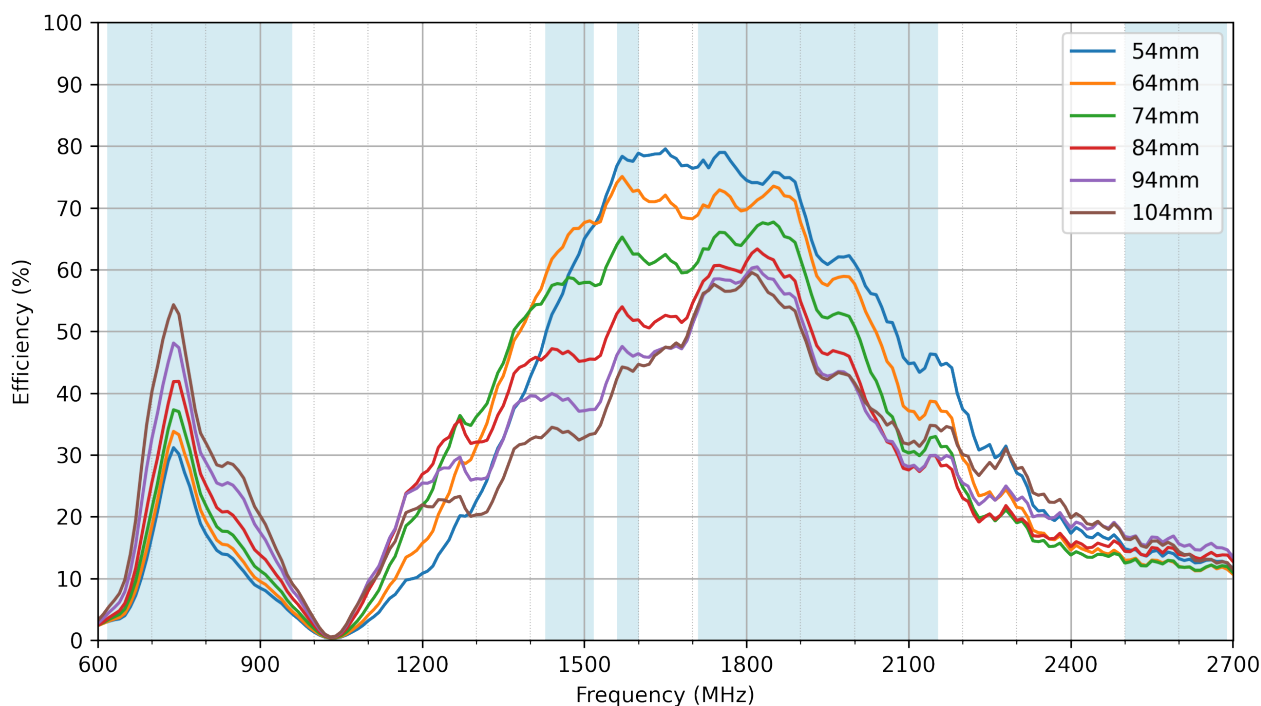

8.2 Average Gain – North America

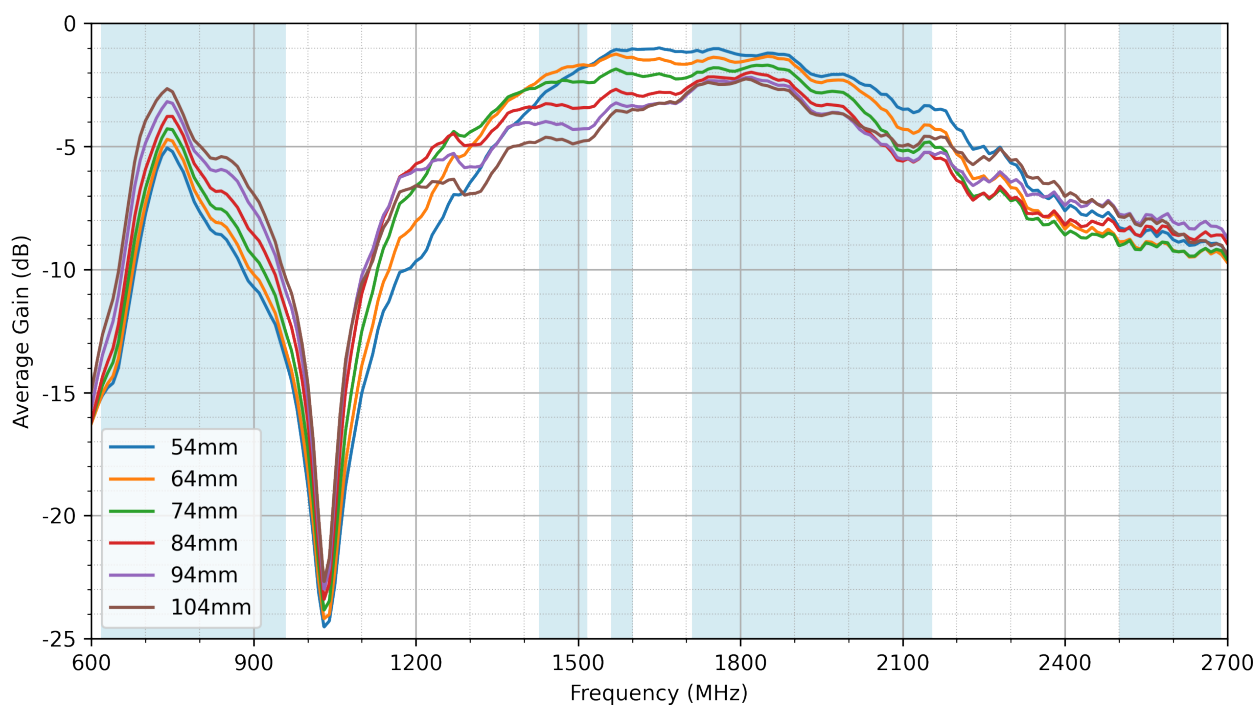

8.3 Peak Gain – North America

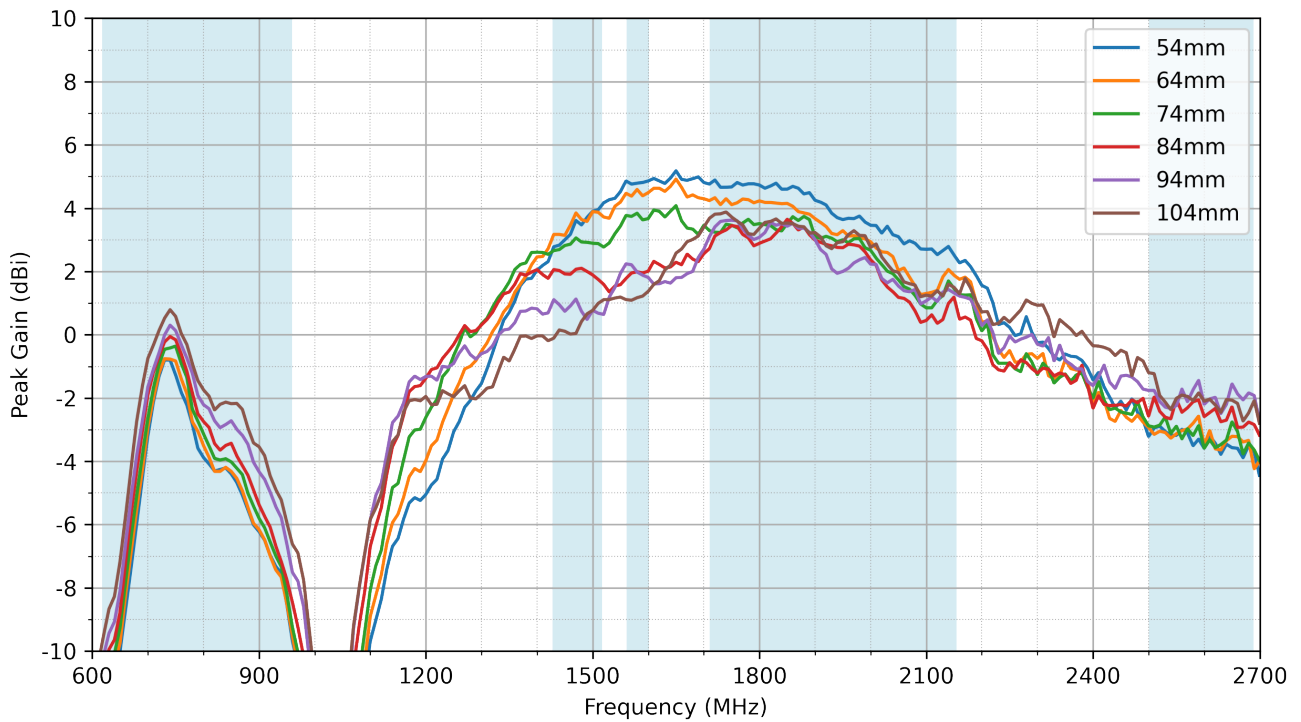

8.4 Efficiency – EMEA

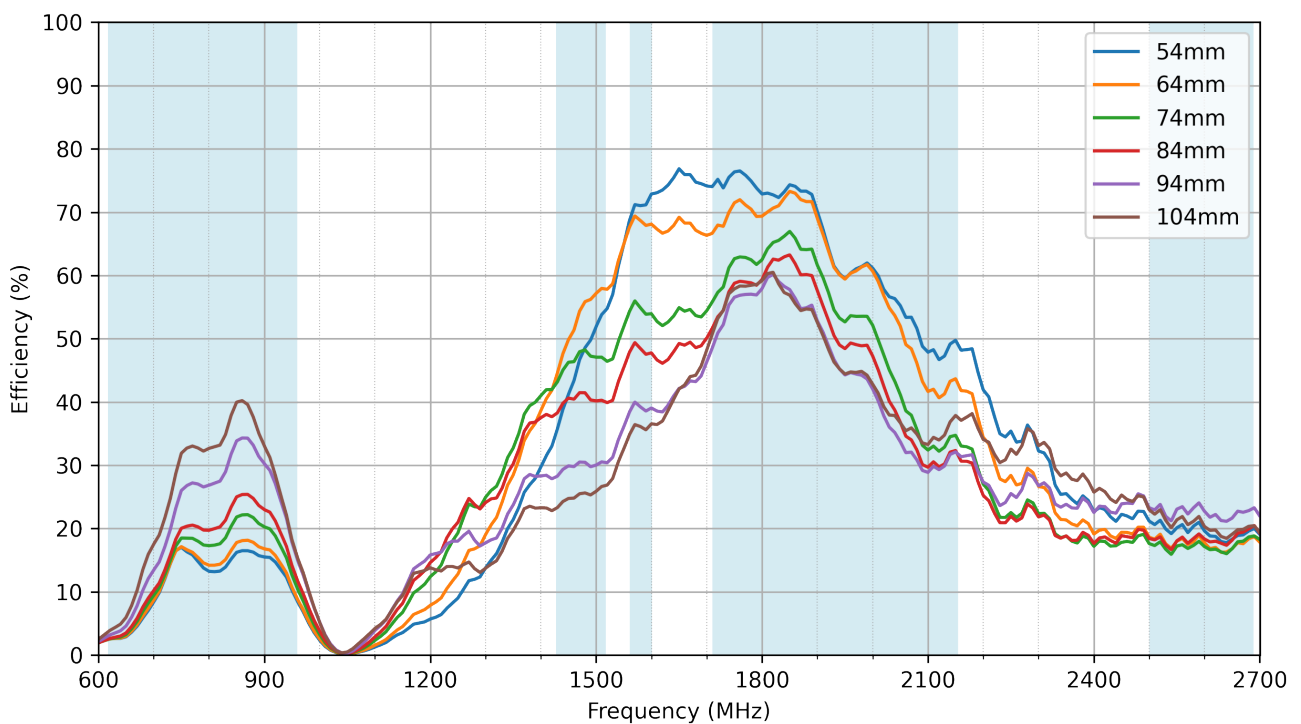

8.5 Average Gain – EMEA

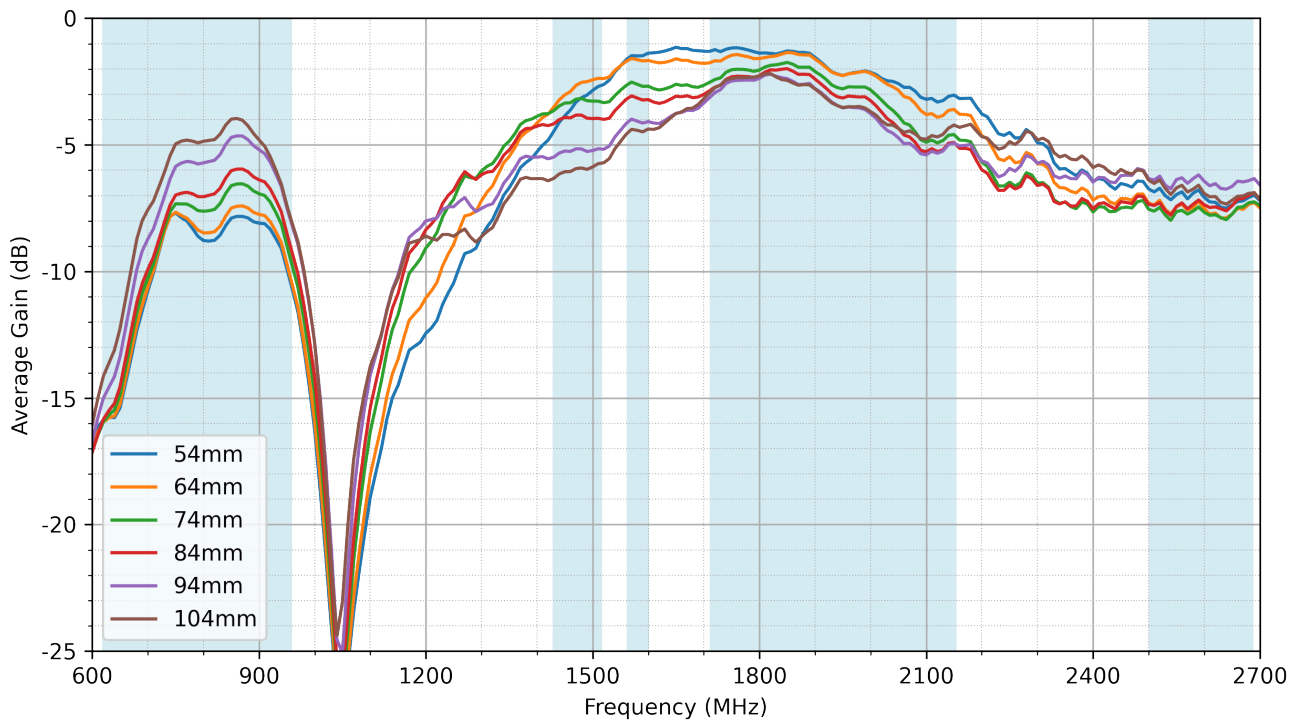

8.6 Peak Gain – EMEA

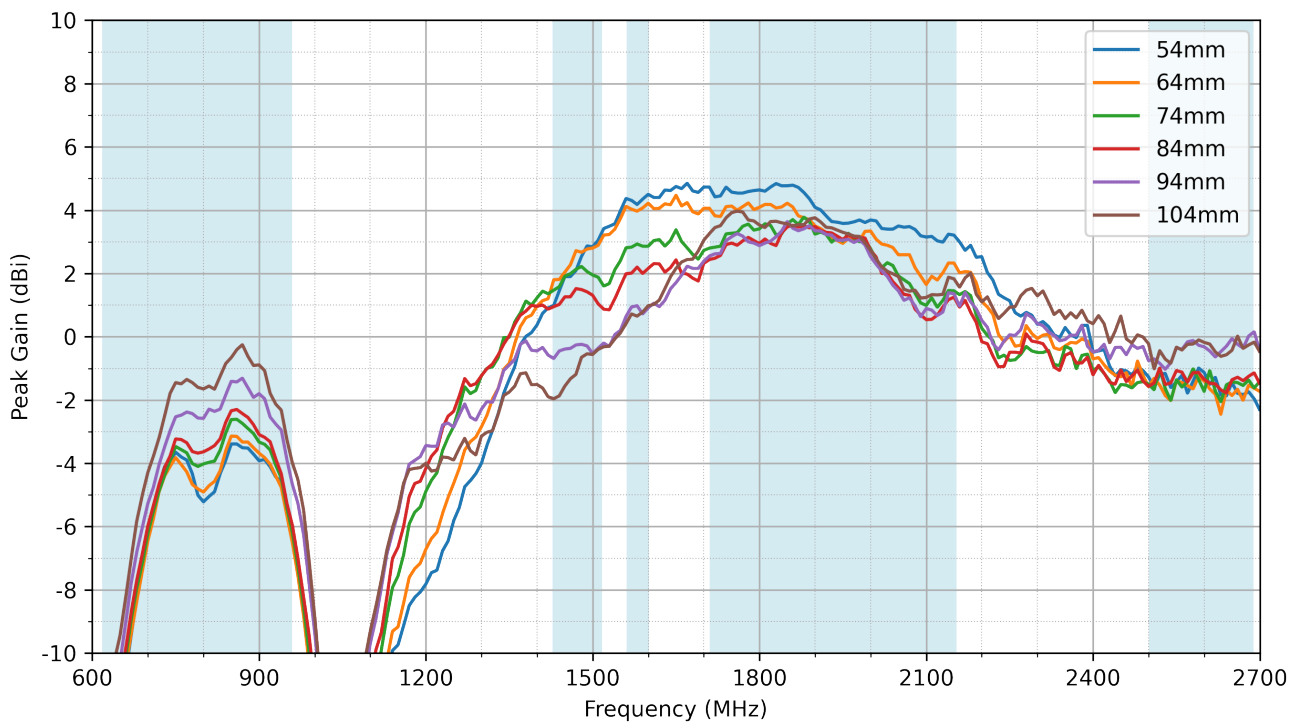

8.7 Efficiency – Worldwide

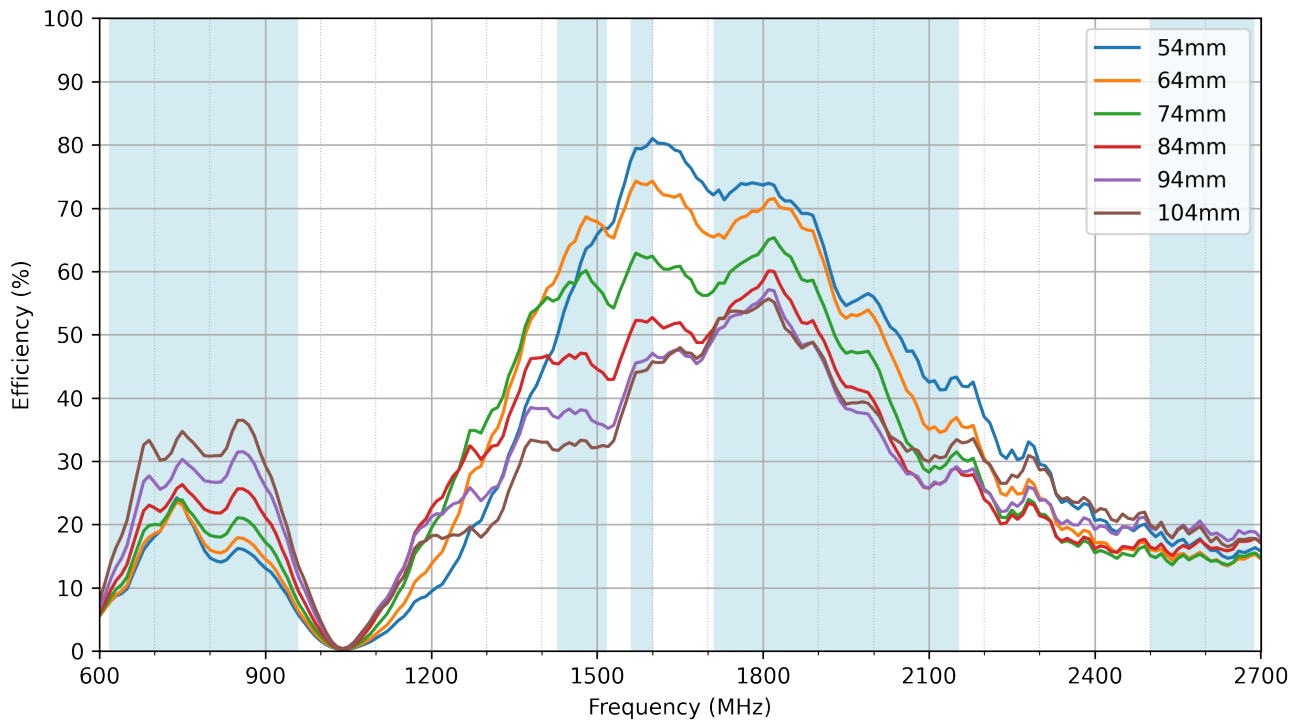

8.8 Average Gain – Worldwide

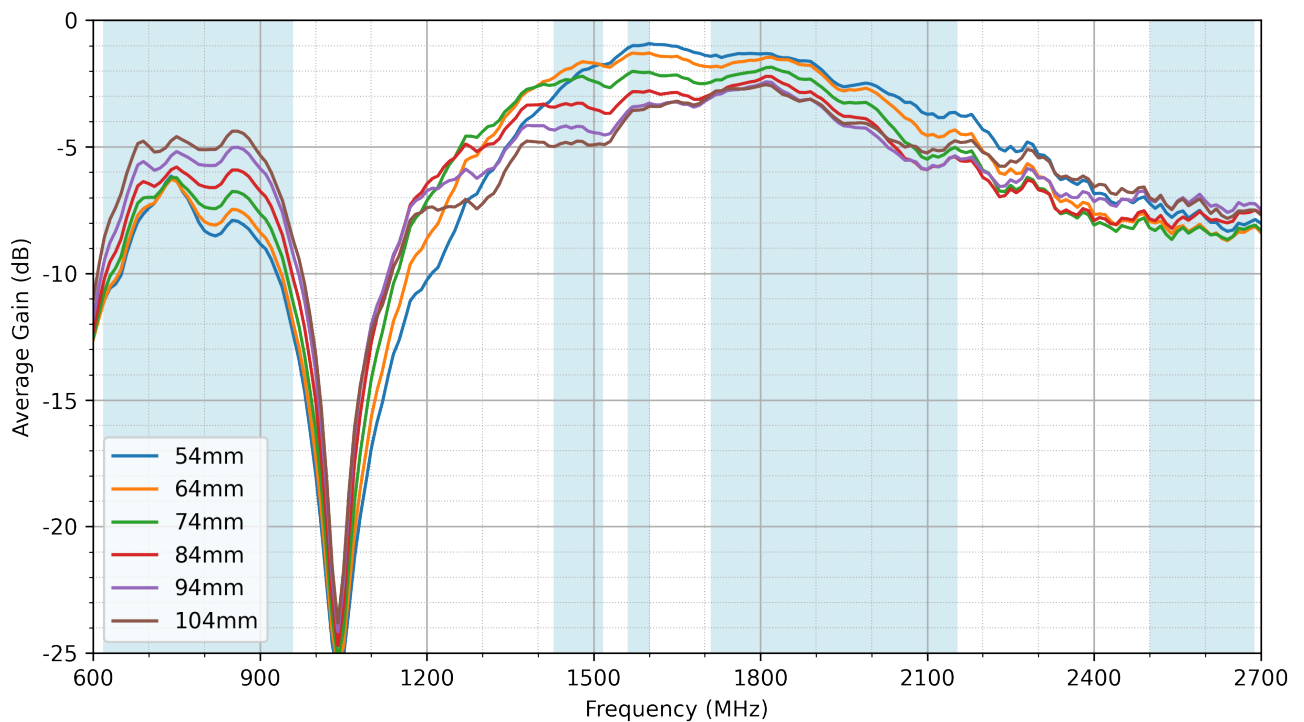

8.9 Peak Gain – Worldwide

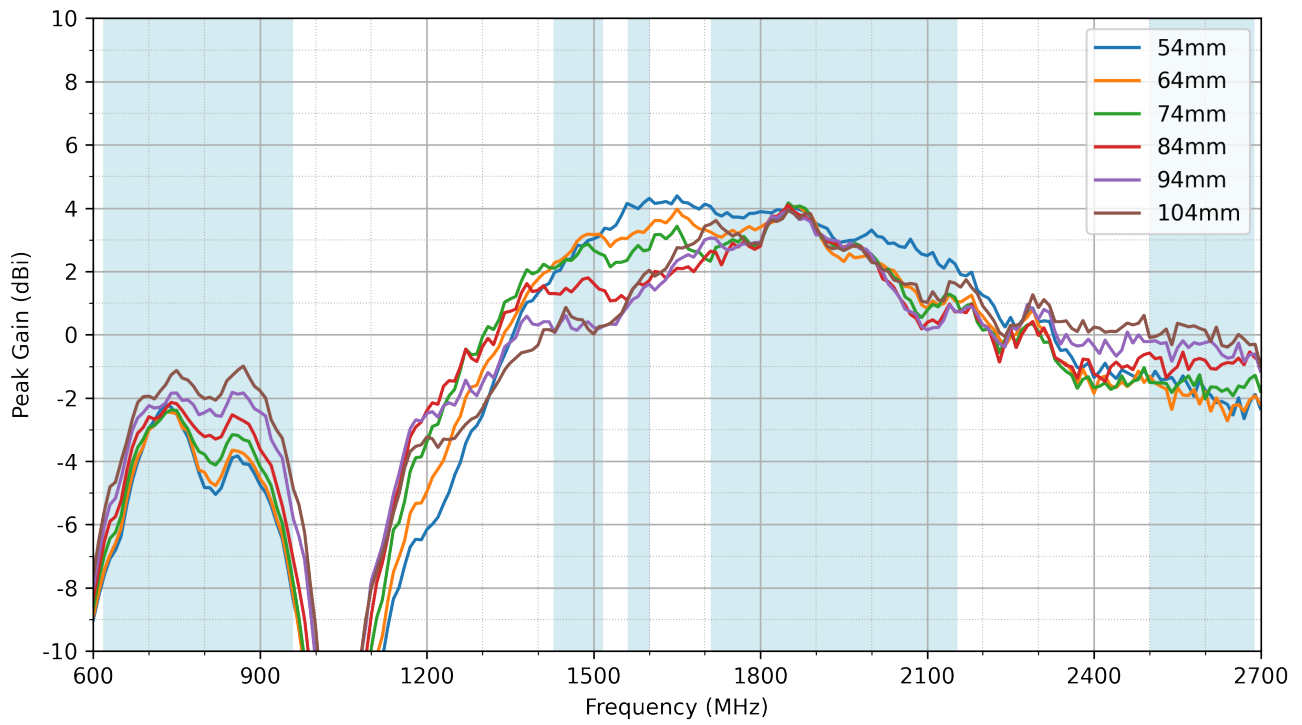

8.10 Effects of Right Side PCB Ground on Antenna Performance

The PCS.55.A antenna was tuned for a 120x80mm ground plane and the distance between the PCB ground on the right side of the antenna was parameterized and swept from 0 to 50 mm. The minimum condition, or 0mm, has the ground right up against the antenna and the maximum condition, or 50mm, has no ground on the right side of the antenna (i.e. a full 80x16mm keep out area). This was done in order to determine the minimum distance that the ground can be placed next to the antenna without affecting performance. The configuration with 25mm is shown below.

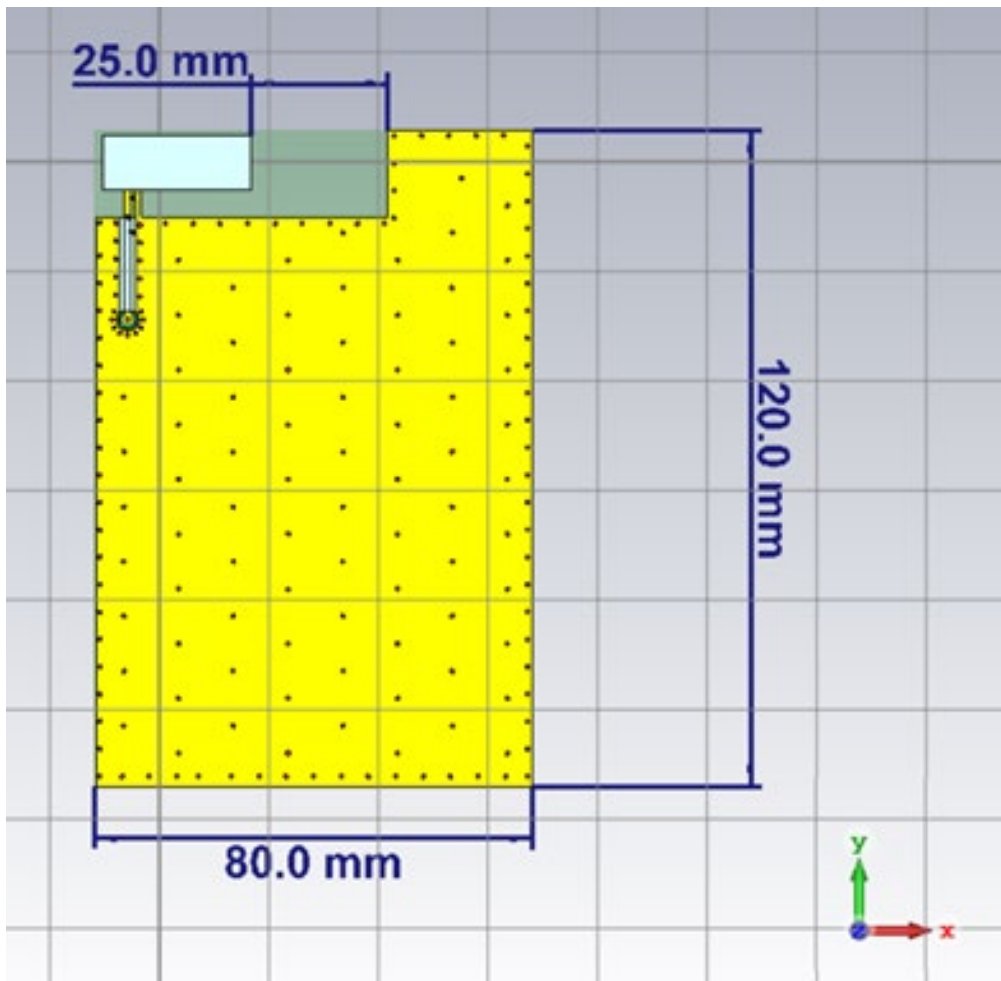

For minimal (0.2 dB) performance impact, a clearance of 25mm is recommended. Return loss and efficiency 25, 35 and 50mm clearance are shown below:

8.10.1 Return Loss

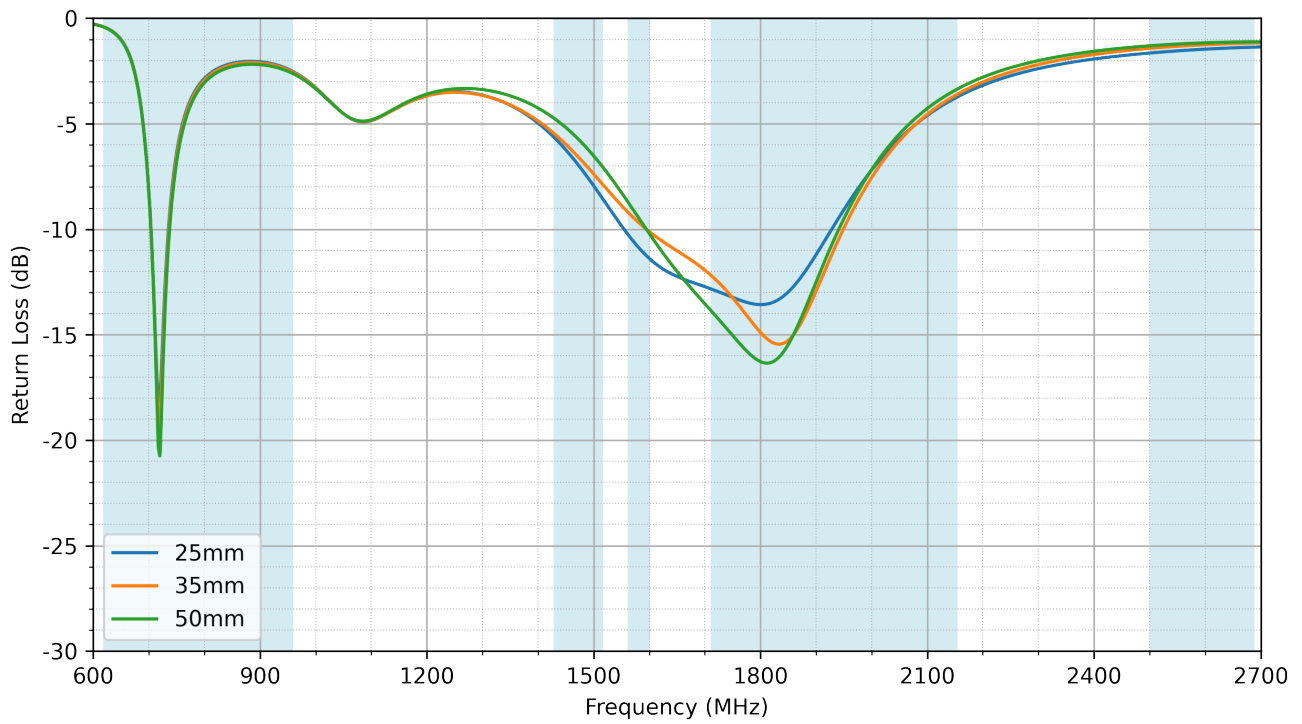

8.10.2 Efficiency

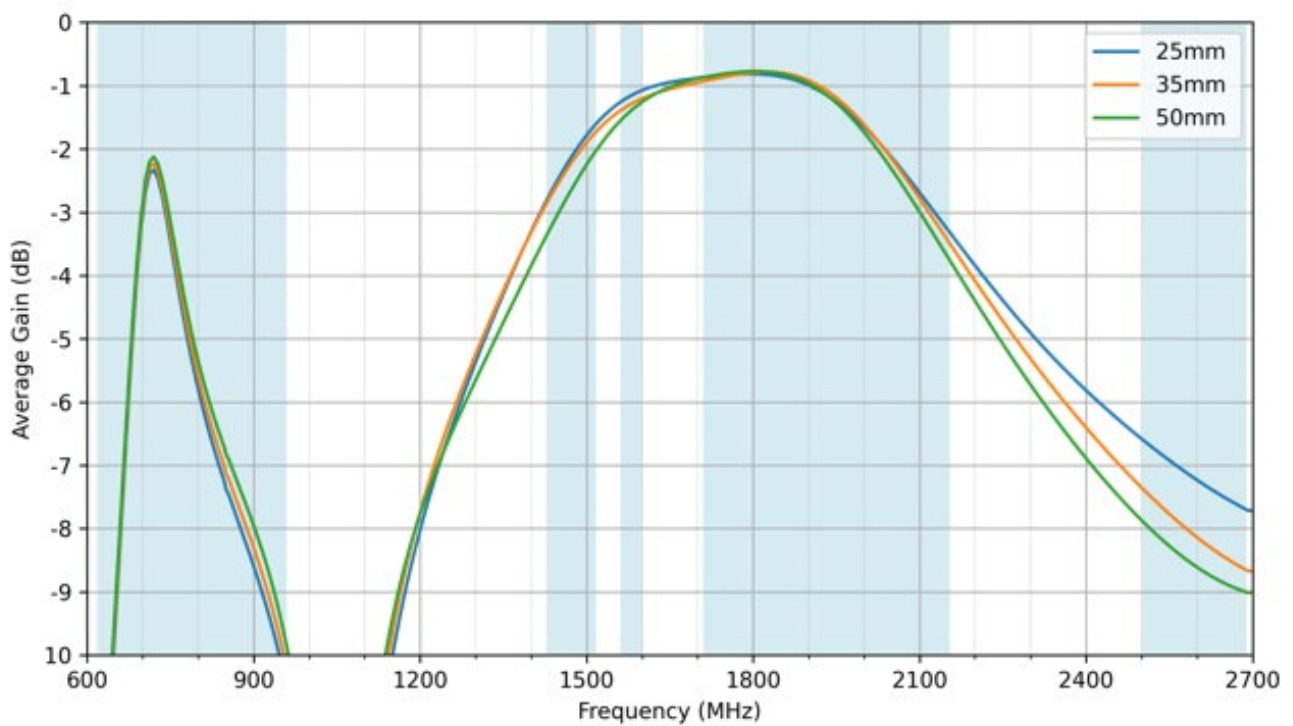

8.10.3 Return Loss

For more compact designs, a distance of 5 or 10mm can be implemented at the cost of efficiency and bandwidth as shown below:

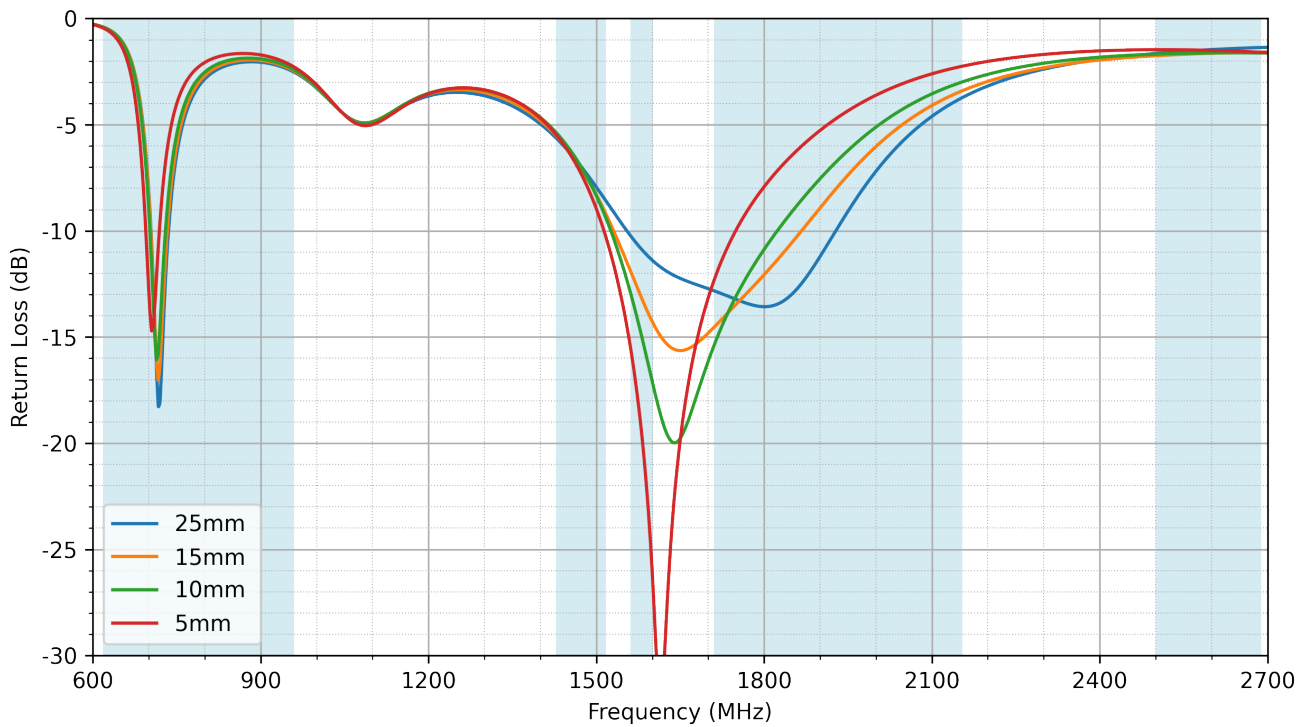

8.10.4 Efficiency

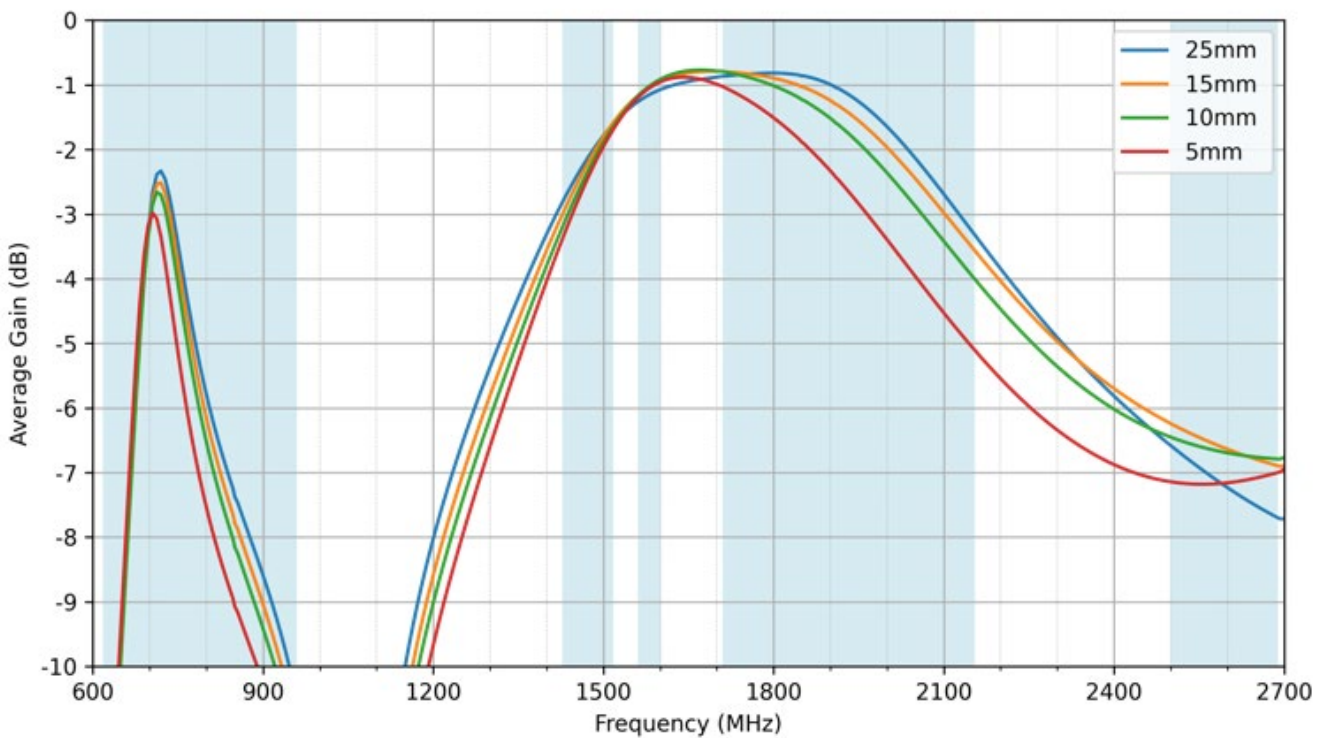

8.11 Correlation of CST Blackbox Model to Measured Results

To evaluate the accuracy of the CST Blackbox Model available to all customers, the following comparisons of return loss and efficiency have been made:

Please note the following simulated results were run at 18 cells/wavelength and with a -80 dB accuracy criterion. The measured results are for the PCS.55.A evaluation board with the NA tuning in place.

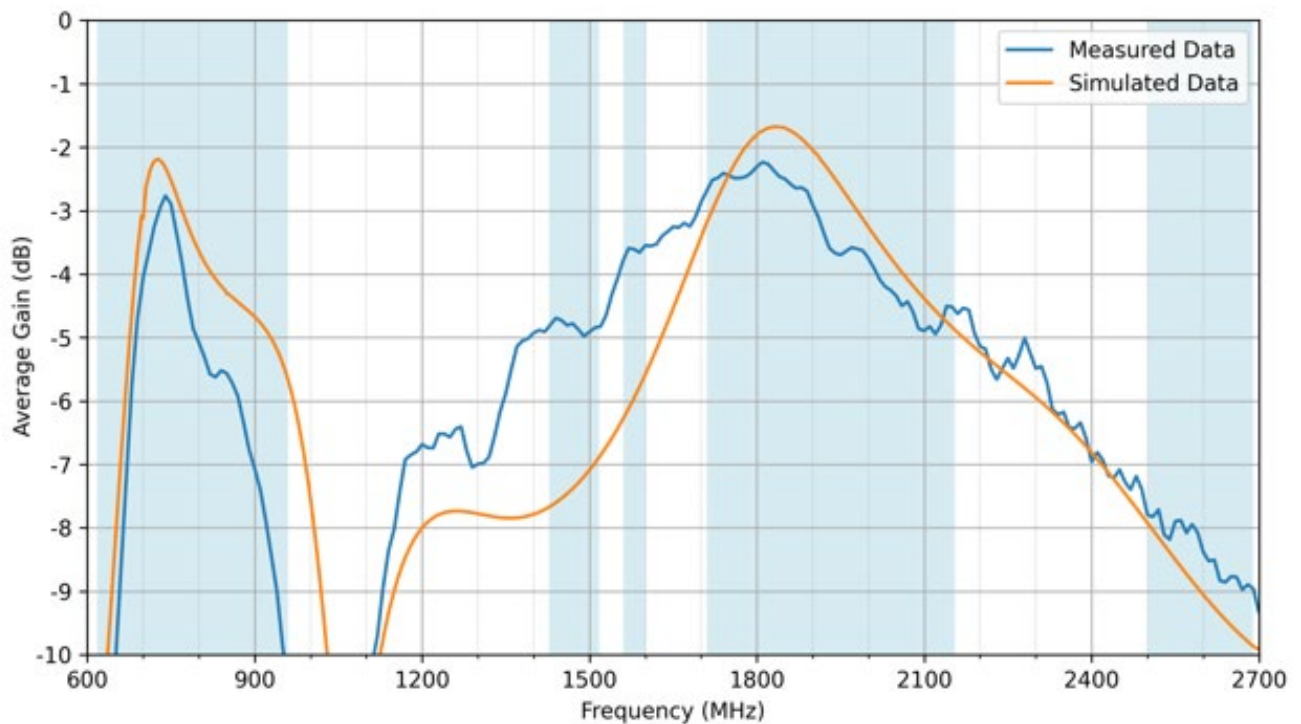
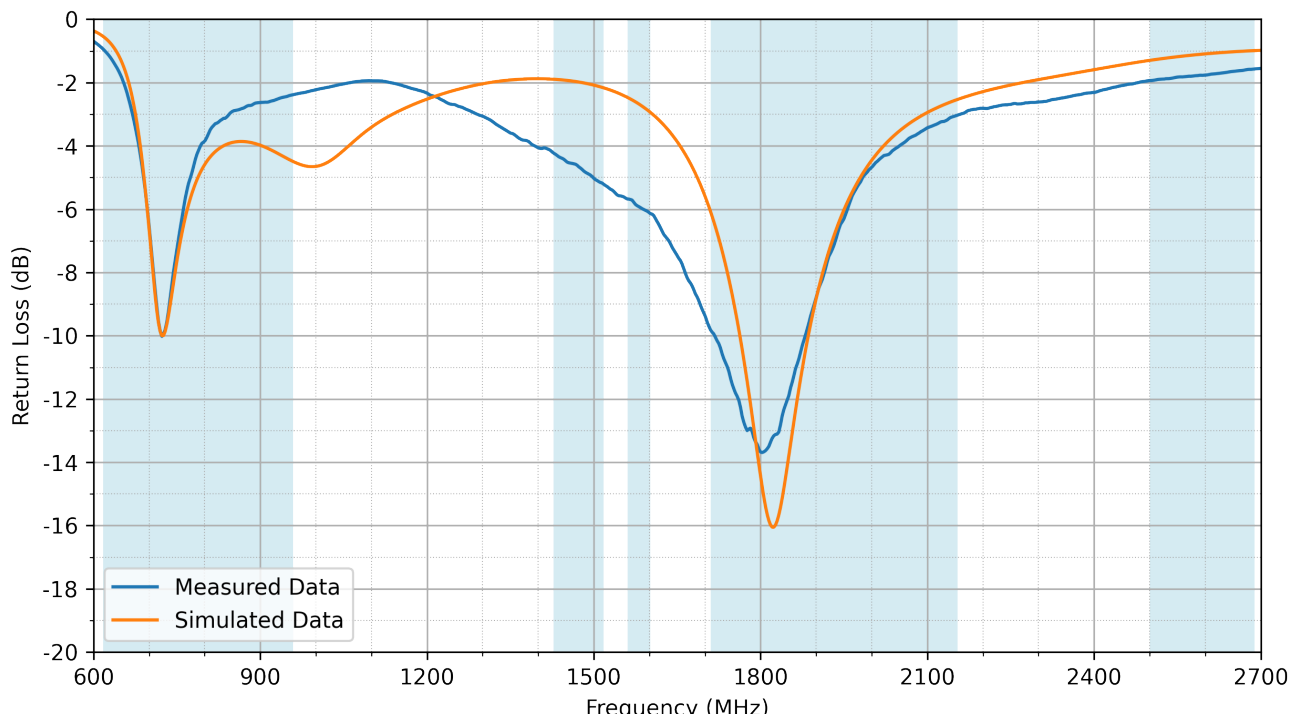

8.12 Repeatability Study

In order to verify the repeatability of the design, 20 production samples of the evaluation board for the PCS.55.A were tested in an anechoic chamber on the same day with standard SMA torque of 1 N·m

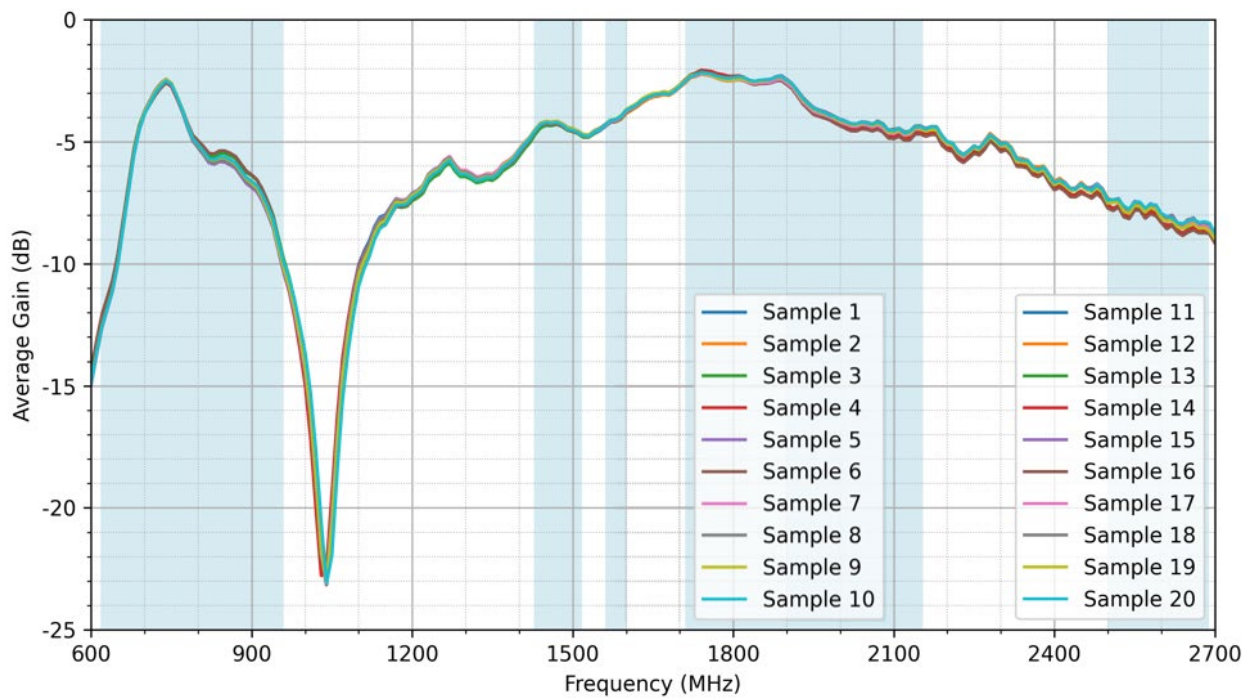

9 Solder Reflow Profile

The PCS.55.A can be assembled by following the recommended soldering temperatures are as follows:

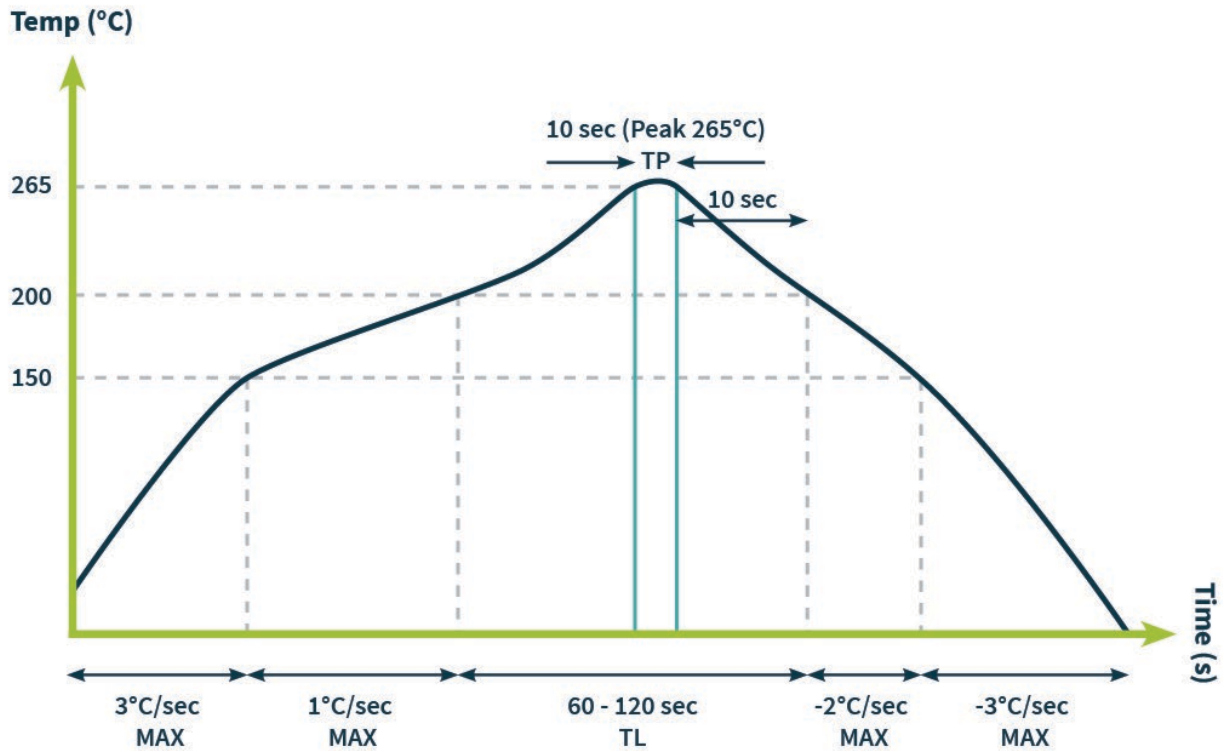

*Temperatures listed within a tolerance of +/- 10° C

The PCS.55.A is not limited to the number of passes through the reflow process. Smaller components are typically mounted on the first pass, however, we do advise mounting the PCS.55.A when placing larger components on the board during subsequent reflows.

Changelog for the datasheet

SPE-23-8-012 – PCS.55.A

Revision: A (First Release)	
Date:	2023-02-10
Changes:	First Release
Changes Made by:	Tim Kelley

Previous Revisions



www.taoglas.com

