

EZ-LIGHT Indicators for 3-Color, 7-Function



Datasheet

DC-operated LED indicators with solid ON or flashing capability and an integral M12 quick-disconnect connector¹

Choose from red, yellow, or green ON, flashing, or rotating (depending on wiring)².





To view or download the latest technical information about this product, including specifications, dimensions, accessories, and wiring, go to www.bannerengineering.com.



WARNING:

- Do not use this device for personnel protection
- Using this device for personnel protection could result in serious injury or death.
- This device does not include the self-checking redundant circuitry necessary to allow its use in personnel safety applications. A device failure or malfunction can cause either an energized (on) or de-energized (off) output condition.

Models

Models	Construction	Inputs
 M18GRY2PQ M18GRY2NQ	Nickel-plated brass housing, M18x1 thread; thermoplastic diffuser. Fully encapsulated; IP67.	PNP
		NPN
 K50LGRY2PQ K50LGRY2NQ	30 mm threaded polycarbonate base, translucent polycarbonate dome. Fully encapsulated; IP67, IP69K per DIN 40050-9.	PNP
		NPN
 K50FLGRY2PQ K50FLGRY2NQ	Polycarbonate base, translucent polycarbonate dome. Fully encapsulated; IP67, IP69K per DIN 40050-9.	PNP
		NPN
 K80LGRY2PQ ³ K80LGRY2NQ	ABS and polycarbonate base, translucent polycarbonate dome. Electronics fully encapsulated; IP67.	PNP
		NPN

The following models are no longer available for order, but are still covered by the information in this document.

Models	Construction	Inputs
 T30GRY2PQ T30GRY2NQ	Thermoplastic polyester housing, thermoplastic diffuser. Fully encapsulated; IP67.	PNP
		NPN

Other Models: Standard integral quick-disconnect connector models are listed (mating cordset required). To order 2 m (6.5 ft) cabled models, omit suffix **Q** from model number (example, M18GRY2P). To order models with 150 mm (6 in) PVC-jacketed cable with 5-pin M12 quick-disconnect connector, replace suffix **Q** with **QP** (example, M18GRY2PQP).

Wiring

Table 1: Select from 7 operating schemes, depending on wiring

LED Function	PNP Models				NPN Models			
	Brown Wire	White Wire	Black Wire	Blue Wire	Blue Wire	White Wire	Black Wire	Brown Wire
Red ON	+V DC			0 V DC	0 V DC			+V DC
Red Flashing	+V DC		+V DC	0 V DC	0 V DC		0 V DC	+V DC
Yellow ON		+V DC		0 V DC		0 V DC		+V DC
Yellow Flashing	+V DC	+V DC		0 V DC	0 V DC	0 V DC		+V DC

¹ Pin 5 is not used; connects to 4-wire quick-disconnect cordset. If a cordset other than those specified in this document is used, use a 5-pin mating cordset.

² Contact Factory for other colors/color combinations, including: blue, white, orange.

³ K80L Models: Standard integral 5-pin M12 quick-disconnect connector models are listed (mating cordset required). For terminal-wired model, omit suffix **Q** (example, K80LGRY2P).



LED Function	PNP Models				NPN Models			
	Brown Wire	White Wire	Black Wire	Blue Wire	Blue Wire	White Wire	Black Wire	Brown Wire
Green ON			+V DC	0 V DC			0 V DC	+V DC
Green Flashing		+V DC	+V DC	0 V DC		0 V DC	0 V DC	+V DC
Rotating Red-Green-Yellow	+V DC	+V DC	+V DC	0 V DC	0 V DC	0 V DC	0 V DC	+V DC

Table 2: Only quick-disconnect wiring is shown; cabled wiring is functionally identical.

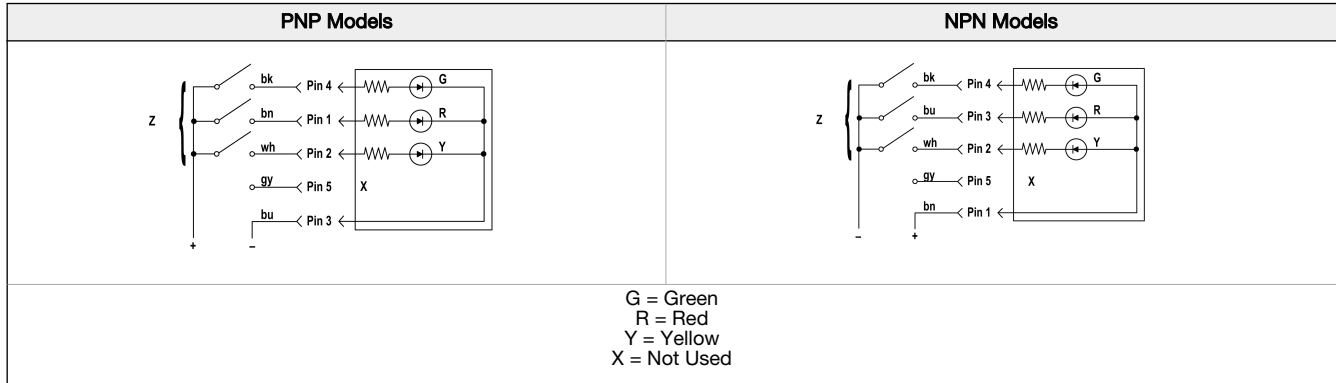

Specifications

Supply Voltage and Current

M18 Models: 10 V DC to 30 V DC at 40 mA max.
T30 Models: 10 V DC to 30 V DC at 50 mA max.
K50L, K50FL and K80L Models: 18 to 30 V DC at 50 mA max.

Indicators

Entire translucent diffuser or dome provides indication.
LEDs are independently selected: Green, Red, Yellow, ON steady or flashing.
For other colors/combinations, contact Factory for availability

Input Response Time

Indicator ON: 250 ms (max.)
Indicator OFF: 10 ms (max.)

Indicator Flash Rate

Single Color: 1 second flash rate (500 ms ON)
Three Color: 1.5 second rotation rate (500 ms per color)

Certifications

All models:



Banner Engineering Europe Park Lane, Culliganlaan 2F bus 3, 1831 Diegem, BELGIUM

K50L, K50FL, and T30 models only:



Turck Banner LTD Blenheim House, Blenheim Court, Wickford, Essex SS11 8YT, Great Britain

K50L models only:



Connections

K80L Models: Integral 5-pin M12 male quick-disconnect connector standard. Terminal-wired models available for use with bulk cable; compression fitting optional. Contact Factory for cable information.
Other Models: Integral 5-pin M12 male quick-disconnect connector (Q); 150 mm (6 in) PVC-jacketed cable with a 5-pin M12 male quick-disconnect connector (QP), (do not use center pin 5); or 2 m (6.5 ft) unterminated 5-wire PVC-jacketed cable

Operating Conditions

Temperature: -40 °C to +50 °C (-40 °F to +122 °F)

Environmental Rating

Rated IP67. K80L has encapsulated electronics only; other models fully encapsulated. K50L, and K50FL quick-disconnect models meet IP69K per DIN 40050-9
Cabled models also meet IP69K if the cable and cable entrance are protected from high-pressure spray.

Required Overcurrent Protection



WARNING: Electrical connections must be made by qualified personnel in accordance with local and national electrical codes and regulations.

Overcurrent protection is required to be provided by end product application per the supplied table.
Overcurrent protection may be provided with external fusing or via Current Limiting, Class 2 Power Supply.
Supply wiring leads < 24 AWG shall not be spliced.
For additional product support, go to www.bannerengineering.com.

Supply Wiring (AWG)	Required Overcurrent Protection (Amps)
20	5.0
22	3.0
24	2.0
26	1.0
28	0.8
30	0.5

Dimensions

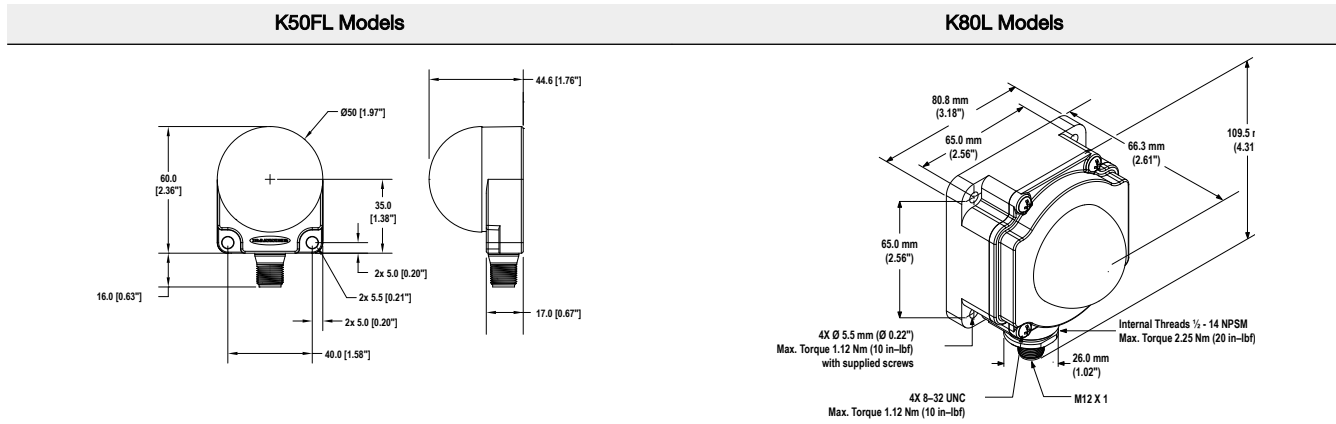
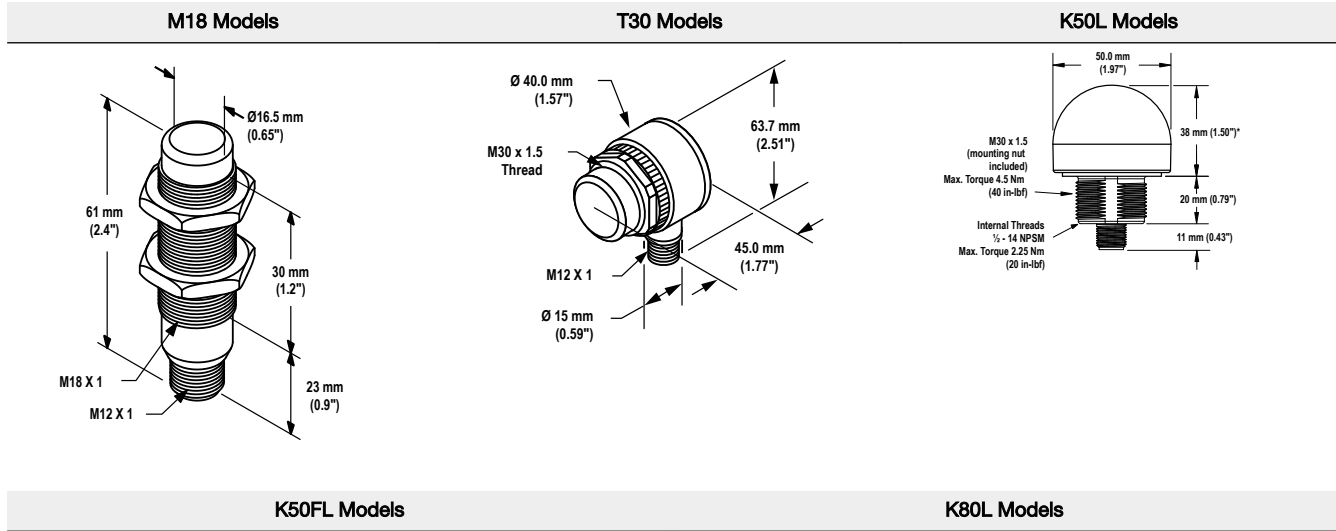

Accessories

Cordsets

4-Pin Threaded M12 Cordsets—Single Ended				
Model	Length	Style	Dimensions	Pinout (Female)
MQDC-406	2 m (6.56 ft)	Straight		
MQDC-415	5 m (16.4 ft)			
MQDC-430	9 m (29.5 ft)			
MQDC-450	15 m (49.2 ft)	Right-Angle		
MQDC-406RA	2 m (6.56 ft)			
MQDC-415RA	5 m (16.4 ft)			
MQDC-430RA	9 m (29.5 ft)			
MQDC-450RA	15 m (49.2 ft)			

To order bulk cable for terminal-wired K80L models, contact the factory. If cables other than those listed are used, use a 5-pin mating cable.

Brackets

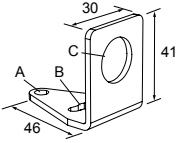
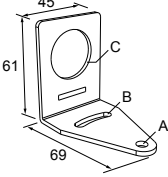
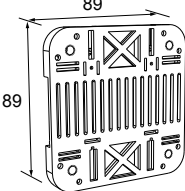
<p>SMB18A</p> <ul style="list-style-type: none"> Right-angle mounting bracket with a curved slot for versatile orientation 12-ga. stainless steel 18 mm sensor mounting hole Clearance for M4 (#8) hardware  <p>Hole center spacing: A to B = 24.2 Hole size: A = ϕ 4.6, B = 17.0 x 4.6, C = ϕ 18.5</p>	<p>For use with M18 and T18 models or base-mount T30 models. Other available 18 mm dia. brackets:</p> <p>SMB1815SF SMB18Q SMB18SF SMB312PD SMBAMS18RA SMBAMS18P</p>
<p>SMB30A</p> <ul style="list-style-type: none"> Right-angle bracket with curved slot for versatile orientation Clearance for M6 (1/4 in) hardware Mounting hole for 30 mm sensor 12-ga. stainless steel  <p>Hole center spacing: A to B=40 Hole size: A=ϕ 6.3, B= 27.1 x 6.3, C=ϕ 30.5</p>	<p>For use with T30 models or base-mount K50L models. Other available 30 mm diameter brackets are:</p> <p>SMBAMS30RA SMBAMS30P SMB30SC SMB30SF SMB30MM SMB3018SC</p>
<p>SMBDX60DIN</p> <ul style="list-style-type: none"> Black reinforced thermoplastic Bracket for mounting on a 35 mm DIN rail 	<p>K50FL models include a 48 mm (1.9 inch) circular velcro mounting kit for easy mounting with no additional hardware</p>

Banner Engineering Corp Limited Warranty

Banner Engineering Corp. warrants its products to be free from defects in material and workmanship for one year following the date of shipment. Banner Engineering Corp. will repair or replace, free of charge, any product of its manufacture which, at the time it is returned to the factory, is found to have been defective during the warranty period. This warranty does not cover damage or liability for misuse, abuse, or the improper application or installation of the Banner product.

THIS LIMITED WARRANTY IS EXCLUSIVE AND IN LIEU OF ALL OTHER WARRANTIES WHETHER EXPRESS OR IMPLIED (INCLUDING, WITHOUT LIMITATION, ANY WARRANTY OF MERCHANTABILITY OR FITNESS FOR A PARTICULAR PURPOSE), AND WHETHER ARISING UNDER COURSE OF PERFORMANCE, COURSE OF DEALING OR TRADE USAGE.

This Warranty is exclusive and limited to repair or, at the discretion of Banner Engineering Corp., replacement. **IN NO EVENT SHALL BANNER ENGINEERING CORP. BE LIABLE TO BUYER OR ANY OTHER PERSON OR ENTITY FOR ANY EXTRA COSTS, EXPENSES, LOSSES, LOSS OF PROFITS, OR ANY INCIDENTAL, CONSEQUENTIAL OR SPECIAL DAMAGES RESULTING FROM ANY PRODUCT DEFECT OR FROM THE USE OR INABILITY TO USE THE PRODUCT, WHETHER ARISING IN CONTRACT OR WARRANTY, STATUTE, TORT, STRICT LIABILITY, NEGLIGENCE, OR OTHERWISE.**

Banner Engineering Corp. reserves the right to change, modify or improve the design of the product without assuming any obligations or liabilities relating to any product previously manufactured by Banner Engineering Corp. Any misuse, abuse, or improper application or installation of this product or use of the product for personal protection applications when the product is identified as not intended for such purposes will void the product warranty. Any modifications to this product without prior express approval by Banner Engineering Corp will void the product warranties. All specifications published in this document are subject to change; Banner reserves the right to modify product specifications or update documentation at any time. Specifications and product information in English supersede that which is provided in any other language. For the most recent version of any documentation, refer to: www.bannerengineering.com.

For patent information, see www.bannerengineering.com/patents.