

EAC series

EAC -10 -472 -□

① ② ③ ④

- ① Model Name
- ② Rated Current
- ③ Line to ground capacitor code: See table 1.1.

table 1.1 Line to ground capacitor code

Code	Leakage Current (Input 125/250V 60Hz)	Line to ground capacitor (nominal value)
681	75.5 μ A/150 μ A max	680pF
102	0.13mA/0.25mA max	1000pF
222	0.25mA/0.5 mA max	2200pF
332	0.38mA/0.75mA max	3300pF
472	0.5 mA/1.0 mA max	4700pF

* When the line to ground capacitor code is different, the attenuation characteristic is different.

- ④ Options
- D: DIN rail installation type

* The dimensions change when the option is set. Refer to External view.

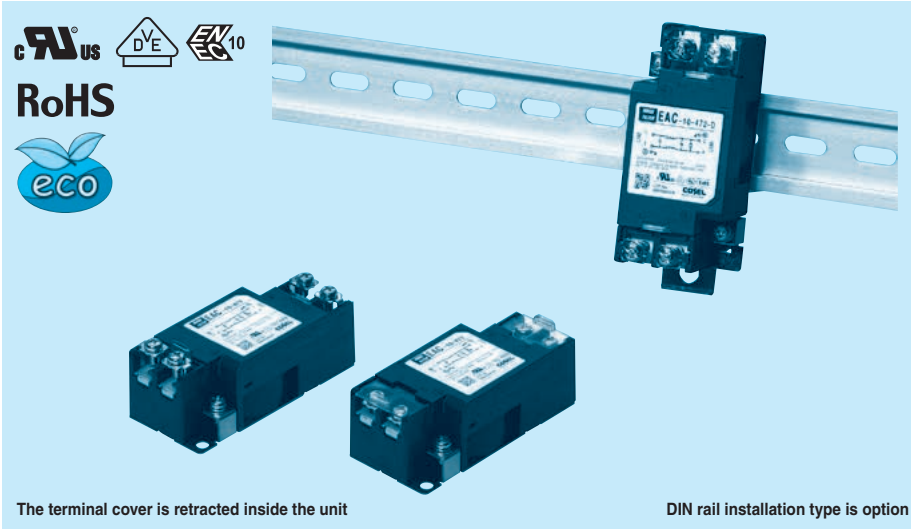

Features of EAC series

Small, common mode EMI/EMC Filters in 150kHz to 1MHz(1-Stage filter)

- Single Phase 250 VAC
 - Small-size
 - Quick and easy push-down terminal
- Just connect the wires, push-down and tighten the screws with a screwdriver**

Specifications

No.	Items	EAC-03-472	EAC-06-472	EAC-10-472	EAC-16-472	EAC-20-472	EAC-30-472
1	Rated Voltage[V]	AC 1 ϕ 250 / DC250					
2	Rated Current[A]	3	6	10	16	20	30
3	Test Voltage (Terminal-Mounting Plate)	2,500 VAC (Cutoff Current = 20mA), 1minute at room temperature and humidity					
4	Isolation Resistance (Terminal-Mounting Plate)	500 VDC 500M Ω min at room temperature and humidity					
5	Leakage current 125/250V 60Hz	0.5mA/1.0mA max					
6	DC resistance	180m Ω max	110m Ω max	40m Ω max	20m Ω max	10m Ω max	6m Ω max
7	Safety agency approval temperatures	-25 to +85 $^{\circ}$ C (Refer to Derating Curve)					
8	Operating temperature	-40 to +85 $^{\circ}$ C (Refer to Derating Curve)					
9	Operating humidity	20 to 95%RH (Non condensing)					
10	Storage temperature/humidity	-40 to +85 $^{\circ}$ C/20 to 95%RH (Non condensing)					
11	Vibration	10 to 55Hz, 19.6m/s 2 (2G), 3min. Period, 1hour each X, Y and Z axis					
12	Impact	196.1m/s 2 (20G), 11ms Once each X, Y and Z axis					
13	Safety agency approvals	UL1283, CSA C22.2 No.8 (C-UL), DIN EN60939 VDE0565 Teil3-1, ENEC (At only AC input)					
14	Case size (without projection) /Weight	39X30X85 mm [1.54X1.18X3.35 inches] (W X H X D) /170g max (Option : -D refer to external view)					

Circuit Diagram

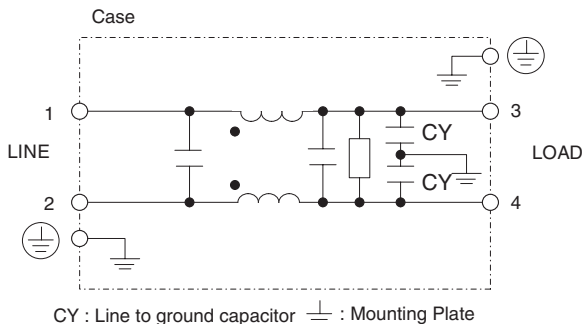

Derating Curve

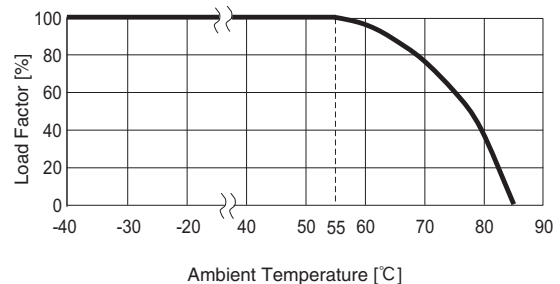

External view

This product is shipped in the following condition, because it is equipped with push-down terminals.

- ① The terminal cover is retracted inside the unit.
- ② The screws for connecting the terminals are held in the up right position.

Standard Type

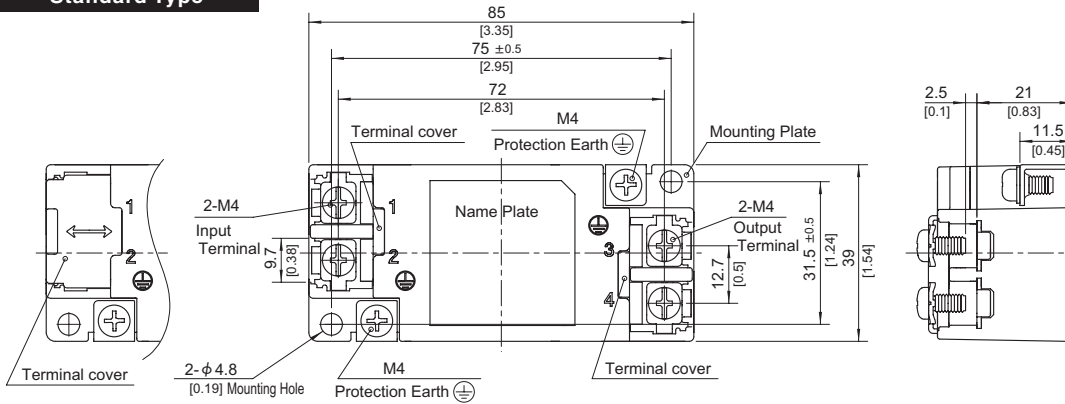

※ Closed the terminal cover

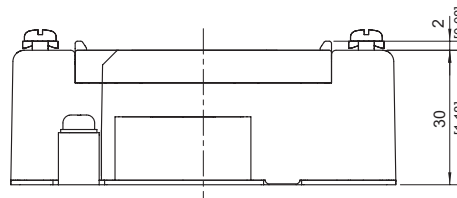

- ※ Tolerance : ± 1 [± 0.04]
- ※ Weight : 170g max
- ※ Mounting Plate : Iron (surface finishing:nickel plating) $t = 1.0$ [0.04]
- ※ Case : PBT
- ※ Dimensions in mm, []=inches
- ※ Terminal block screw tightening torque M4 : $1.6N \cdot m$ (16.9kgf · cm)max

DIN rail installation Type

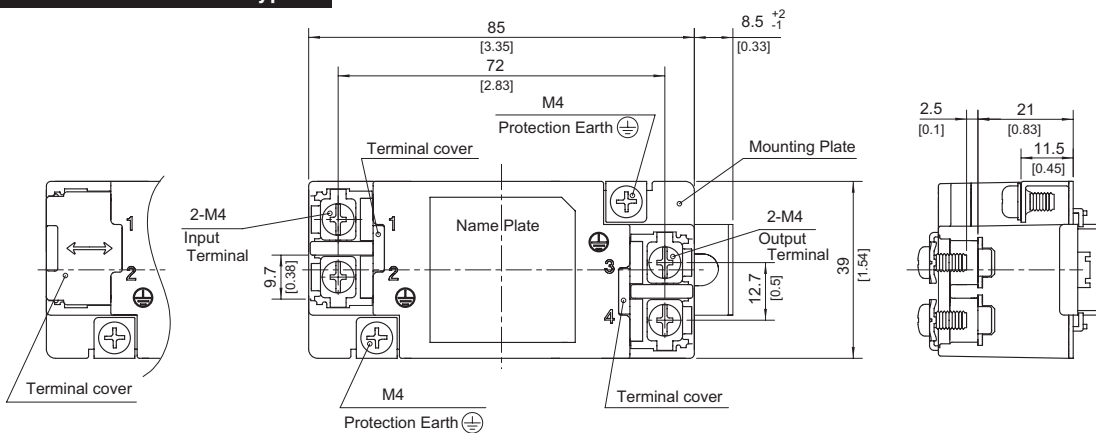

※ Closed the terminal cover

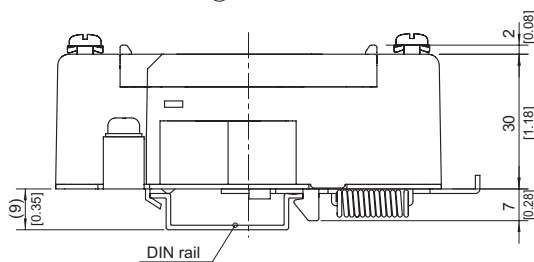

- ※ Tolerance : ± 1 [± 0.04]
- ※ Weight : 170g max
- ※ Mounting Plate : Iron (surface finishing:nickel plating) $t = 1.0$ [0.04]
- ※ Case : PBT
- ※ Dimensions in mm, []=inches
- ※ Terminal block screw tightening torque M4 : $1.6N \cdot m$ (16.9kgf · cm)max

■Note when installing the EMI/EMC Filter on a DIN rail.

When the EMI/EMC Filter is grounded through the DIN rail, the proper noise attenuation may not be achieved.

Be sure to connect the protection earth (PE) of the EMI/EMC Filter body to the earth.

It can connect the ground to either one only.

