

# LD30EPBR30BPxxIO - IO-Link



## Photoelectric Laser sensor with BGS, FGS and IO-Link communication



### Benefits

- **Red laser class 1 assure reliable detection**
- **Red Laser BGS or FGS Long Range** sensor with IO-Link with an adjustable distance of 20 to 325 mm, either by Teach-button or via IO-Link.
- **Dual Detection mode** - Combine Foreground detection with Diffuse Reflective detection.
- **Triangulating sensing principle.**
- **Application functions:** Dual Detection, Pattern Recognition, Speed & Length, Divider function and Object & Gap Monitoring.
- **Neighbour Immunity**, select up to 3 neighboring sensors.
- **Easy customization** to specific OEM requests by use of the build in IO-Link functionalities.
- **The output can be operated** either as a standard switching output or in IO-Link mode.
- **Fully configurable via output IO-Link v 1.1.** Electrical outputs can be configured as PNP / NPN / Push-Pull / External input, normally open or normally closed.
- **Timer functions** can be set, such as ON-delay, Off-delay, and one shot.
- **Logging functions:** Temperature, detecting counter, power cycle and operating hours.
- **Detection modes** Background suppression (BGS), single point, two point, windows and foreground suppression (FGS) mode.
- **Logic functions:** AND, OR, XOR and Gated SR-FF.
- **Analogue output:** In IO-Link mode the sensor will generate 16 bit analogue process data output representing various selectable process data such as received signal level.

### Description

The LD30EPBR30BPxxIO are a part of the latest generation of high performance Photoelectric Laser sensors designed to solve challenging detection tasks due to Laser, Background Suppression, Foreground Suppression and Dual Detection features. The small light spot makes detection very precise.

The LD30EPBR30BPxxIO stainless steel sensors are manufactured with high-quality materials designed for harsh environments.

They are intended for use in environments where high-pressure cleaning (IP69K), cleaning agents and disinfectants are used daily, thanks to their ECOLAB approval.

The strong stainless steel (AISI316L) together with high-quality plastic materials like PMMA and PES sealings of FKM ensure a safe and excellent mechanical resistance.

The compact sensor design is ideally suited to confined spaces.

### IO-Link



### Applications

**Detecting of transparent** or translucent plastic bottles.

**The detection distance** is almost independent of the colour of the object to detect.

**Dual Detection:** A dual detection sensor works as a foreground suppression sensor combined with a diffuse reflective sensor. This sensing principle evaluates both the position change as well as the light intensity of the received light. This allow detection of eg. transparent PET bottles.



**Pattern Recognition:** An easy way to verify that a product is manufactured to the specification e.g. Furniture production where tabs or holes has to be with a defined pattern.

**Speed and Length:** Monitor the speed and length of an object on a conveyour for e.g. sorting on size.

**Divider function:** A de-central counting function that gives a signal when a preset count level is reached e.g. when a certain amount of items are packed in a carton box it ask for a new box.

**Object and Gap Monitoring:** Function that can sort out good objects and gaps between them so e.g. a packaging machine only receive objects with the correct size and gaps.

### Main functions

- The detection distance is almost independent of the colour of the object to detect.
- The sensor can be operated in IO-Link mode once connected to an IO-Link master or in standard I/O mode.
- Measured sensing distance as process data.
- Neighbour interference protection.
- Sensing distance by teach-button, teach by wire or by IO-link parameter.
- Quality of Run and Quality of Teach result.
- Temperature data for preventive maintenance.
- Front-end check for preventive maintenance.
- Dual Detection

## References

### Product selection key



LD30EPBT30BP  IO

Enter the code option instead of

| Code                     | Option | Description  |
|--------------------------|--------|--|
| L                        | -      | Sensing principle: Photoelectric laser sensor  |
| D                        | -      | Rectangular housing  |
| 30                       | -      | Length of housing  |
| E                        | -      | Stainless steel  |
| P                        | -      | Teach-button   |
| B                        | -      | Background / Foreground suppression  |
| R                        | -      | Red light  |
| 30                       | -      | Sensing distance: 300 mm   |
| B                        | -      | <b>Selectable functions:</b> NPN, PNP, Push-Pull, External Input (only pin 2) or External teach input (only pin 2) |
| P                        | -      | <b>Selectable:</b> N.O. or N.C.  |
| <input type="checkbox"/> | A2     | Cable, 2 m   |
|                          | M5     | Connector M8 4-pin   |
| IO                       | -      | IO-Link version  |

**▶ Type selection**

| <b>Conne-<br/>ction</b> | <b>Housing</b>  | <b>Light type</b> | <b>Code</b>             |
|-------------------------|-----------------|-------------------|-------------------------|
| Cable                   | Stainless steel | Red laser class 1 | <b>LD30EPBR30BPA2IO</b> |
| Plug                    | Stainless steel | Red laser class 1 | <b>LD30EPBR30BPM5IO</b> |

## Structure

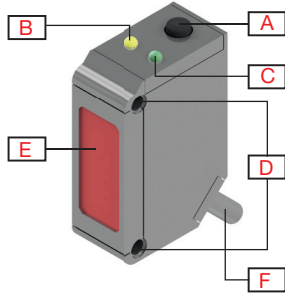

Fig. 1 Cable

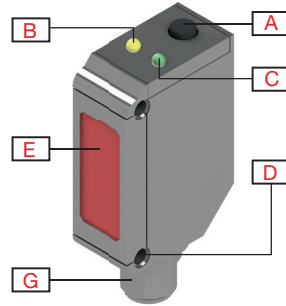

Fig. 2 Plug

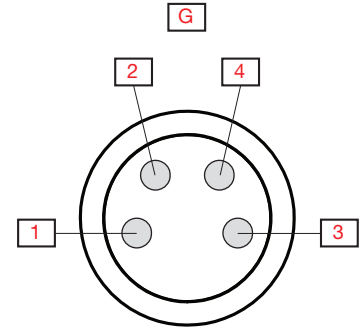
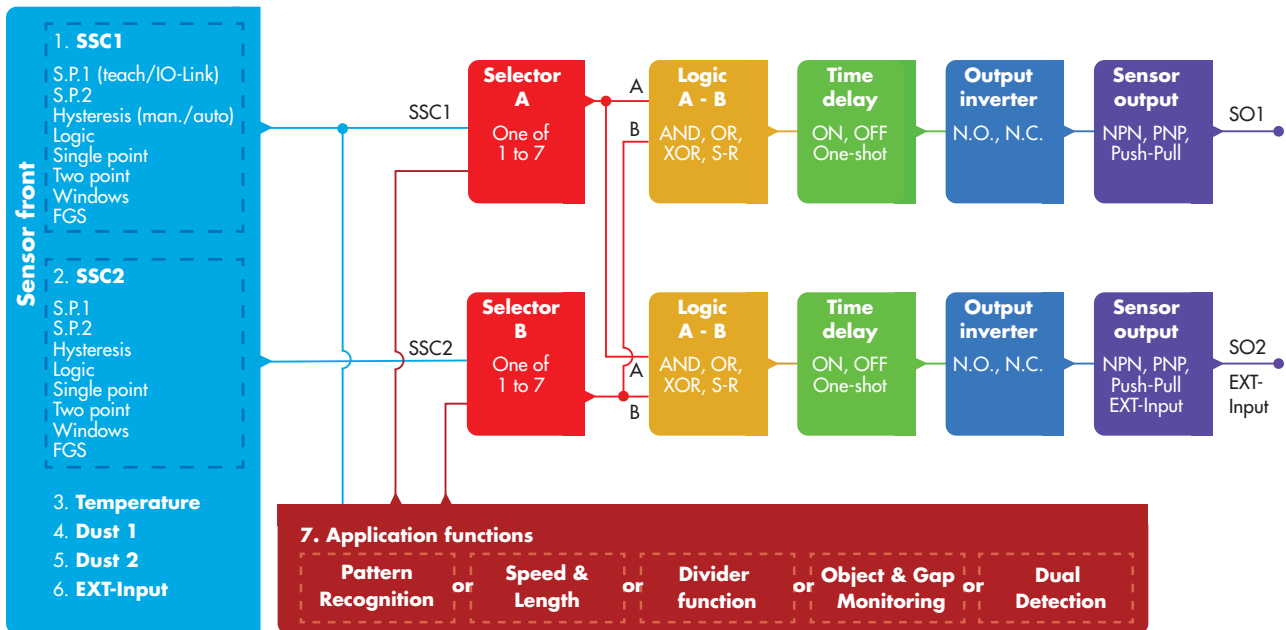

Fig. 3 "M8-plug" Pin numbers

|          |                                     |          |                          |
|----------|-------------------------------------|----------|--------------------------|
| <b>A</b> | Teach-button                        | <b>G</b> | M8, 4-pin male connector |
| <b>B</b> | Yellow LED                          | <b>1</b> | Brown, +V                |
| <b>C</b> | Green LED                           | <b>2</b> | White, IN/OUT            |
| <b>D</b> | M3 Fixing holes for sensor mounting | <b>3</b> | Blue, -V                 |
| <b>E</b> | Sensing window                      | <b>4</b> | Black, OUT/IO-Link       |
| <b>F</b> | 2 m, 4 wire PVC Ø 3.3 mm cable      |          |                          |

# Sensing

## Detection



|  |   |   |
|--|---|---|
| Set Point 1 (SP1)                          | <ul style="list-style-type: none"> <li>• 20 ... 325</li> </ul> <b>Factory settings:</b> 300 (Approx. 300 mm @ Reference target 90% reflection)  |   |
| Set Point 2 (SP2)                          | <ul style="list-style-type: none"> <li>• 20 ... 325</li> </ul> <b>Factory settings:</b> 20 (Approx. 20 mm @ Reference target 90% reflection)  |   |
| Switching logic                            | <ul style="list-style-type: none"> <li>• High active</li> <li>• Low active</li> </ul> <b>Factory settings:</b> High active  |   |
| Switching mode                             | <b>SSC1</b> <ul style="list-style-type: none"> <li>• Deactivated</li> <li>• Single point mode</li> <li>• Two point mode</li> <li>• Windows mode</li> <li>• FGS mode</li> </ul> <b>Factory settings:</b> Single point mode               | <b>SSC2</b> <ul style="list-style-type: none"> <li>• Deactivated</li> <li>• Single point mode</li> <li>• Two point mode</li> <li>• Windows mode</li> <li>• FGS mode</li> </ul> <b>Factory settings:</b> Deactivated |
| Rated operating distance ( $S_n$ )         | ≤ 300 mm  | Reference target, white paper with 90 % reflectivity, Size 200x200 mm   |
| Maximum detection distance<br>Precise mode | ≤ 300 mm  | White object 90% reflection   |
|  | ≤ 300 mm  | Grey object 18% reflection  |
|  | ≤ 300 mm  | Black object 6% reflection  |
| Cutoff distance                            | 20...350 mm<br><b>Factory settings:</b> 350 mm<br>Measured distance beyond cut off distance, will be truncated to cut off distance.<br>Cut off distance value will also be used when an object cannot be detected.                      |   |
| Sensitivity control (selectable between)   | <ul style="list-style-type: none"> <li>• IO-Link Adjustment (SSC1)</li> <li>• Teach-button (SSC1)</li> </ul> <b>Factory settings:</b> Teach-button  |   |
| Sensitivity adjustment                     | 20 mm ... 325 mm  | Teach-button  |
| Blind zone                                 | ≤ 15 mm   | White object 90% reflection   |
|  | ≤ 17.5 mm   | Grey object 18% reflection  |
|  | ≤ 20 mm   | Black object 6% reflection  |
| Light source / Light type                  | 650 nm / Red laser modulated, class 1   |   |
| Typical lifetime Laser                     | > 50 000 h  |   |
| Detection angle                            | ± 0.2° Fast mode, ± 0.4° Precise mode @ 150 mm  |   |
| Light spot size                            | Ø 1.0 mm @ 300 mm (1/e <sup>2</sup> )   |   |
| Emitter beam angle                         | ± 0.01°   |   |
| Adjustable distance                        | 20 ... 325 mm<br><b>Factory settings:</b> SP1 300 and SP2 20  | White object 90% reflection   |
|  | 20 ... 325 mm<br><b>Factory settings:</b> SP1 300 and SP2 20  | Grey object 18% reflection  |
|  | 20 ... 325 mm<br><b>Factory settings:</b> SP1 300 and SP2 20  | Black object 6% reflection  |
| Hysteresis (H)                             | Adjustable by IO-Link <ul style="list-style-type: none"> <li>• Manual 1.0 mm ... 325.0 mm</li> <li>• Robust automatic</li> <li>• Fine automatic</li> </ul> <b>Factory settings:</b> Fine automatic                                      |   |
| Detection filter                           | This function can increase the immunity towards unstable targets and electromagnetic disturbances: Value can be set from 1 to 255.<br><b>Factory settings:</b> 1<br>(1 is max. operating frequency and 255 is min. operating frequency) |   |

|                                     |   |                                  |
|-------------------------------------|---|----------------------------------|
| <b>Mutual Inteferece Protection</b> | <ul style="list-style-type: none"> <li>• MIP Off</li> <li>• One channel</li> <li>• 2 channels - CH A</li> <li>• 2 channels - CH B</li> <li>• 3 channels - CH A</li> <li>• 3 channels - CH B</li> <li>• 3 channels - CH C</li> </ul> | <b>Factory settings:</b> MIP Off |
|-------------------------------------|---|----------------------------------|

## ▶ Application functions

|  |  |   |
|--|--|---|
| <b>Selectable dedicated applications</b> | <ul style="list-style-type: none"> <li>• No application</li> <li>• Dual Detection</li> <li>• Pattern Recognition</li> <li>• Speed and Length</li> <li>• Divider function</li> <li>• Object and Gap Monitoring</li> </ul> | <b>Factory settings:</b> No application |
|--|--|---|

## Dual Detection

A standard Foreground Suppression sensor expects to see a background within a certain specified tolerance. An object is detected if the received light's position exceeds those tolerances set for the background.

A standard Diffuse Reflective (energized) sensor detects the intensity of the received light and if it exceeds a set threshold an object is detected.

A Dual Detection sensor works as a Foreground Suppression sensor combined with a Diffuse Reflective sensor. This sensing principle evaluates both the position change as well as the light intensity of the received light.

|                       |  |
|-----------------------|--|
| <b>Dual Detection</b> | <ul style="list-style-type: none"> <li>• Teach distance</li> <li>• Teach excess gain</li> <li>• Set Point</li> <li>• Hysteresis</li> <li>• Auto level</li> </ul> |
|-----------------------|--|

## Pattern Recognition

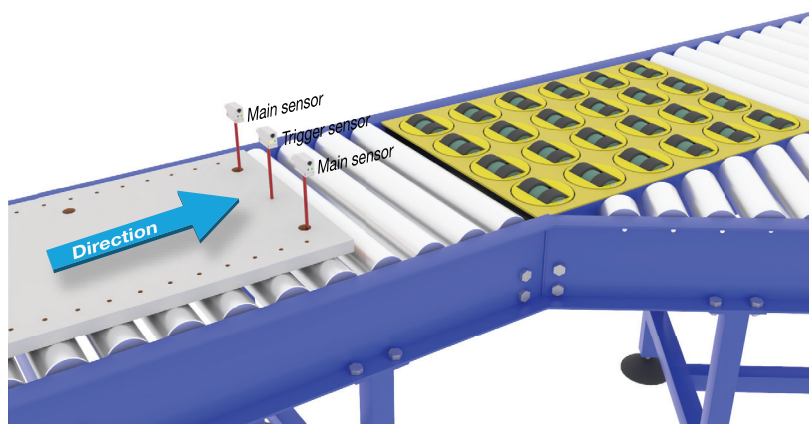

|                             |   |
|-----------------------------|---|
| <b>Function description</b> | The Pattern recognition function detects a pattern (e.g. a row of holes or pins) and compares the order with a pre-teached reference pattern.   |
| <b>Conditions</b>           | Two sensors (Main sensor and Trigger sensor) are needed for this function.  |
| <b>Settings</b>             | <ul style="list-style-type: none"> <li>• The Trigger sensor has to detect the full length of the body that contains the pattern.</li> <li>• The Main sensor has to be aimed at the e.g. holes or pins that constitute the pattern.</li> </ul> |

## Speed and Length

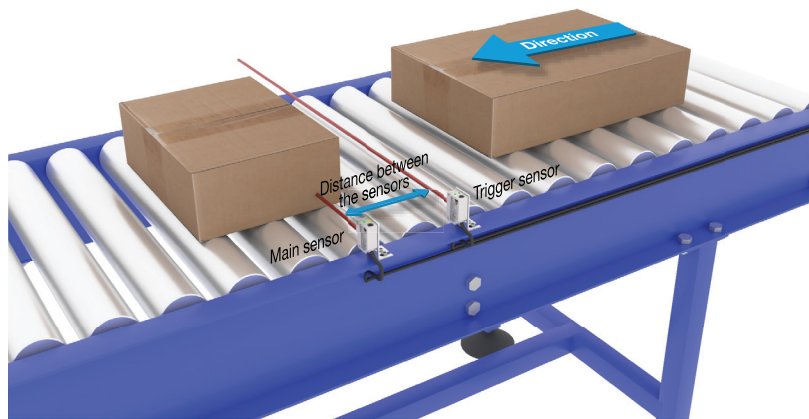

|                             |  |  |
|-----------------------------|--|--|
| <b>Function description</b> | This function is designed to monitor the length of an object as well as the speed of a conveyor belt. The actual value of the length in [mm] and the speed in [mm/s] are directly available on the IO-Link master. |  |
| <b>Conditions</b>           | Two sensors (Main sensor and Trigger sensor) are needed for this function.   |  |
| <b>Settings</b>             | □□□□□□□□ Distance between sensors.   | 25 ... 150 mm<br><b>Factory settings:</b> 100 mm |

## Divider function

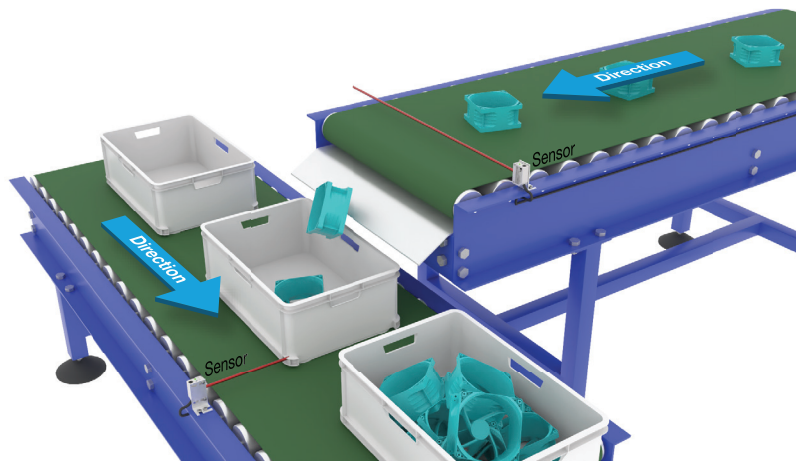

|                             |  |  |
|-----------------------------|--|--|
| <b>Function description</b> | This function can be used to e.g. monitor how many items are packed into a carton box. Once the preset number is reached the sensor gives an output so the full box can be replaced. |  |
| <b>Conditions</b>           | Only one sensor is needed for this function.   |  |
| <b>Settings</b>             | A counter value must be set in the sensor.   |  |
|                             | Counter limit.   | 1...60 000<br><b>Factory settings: 5</b> |

## Object and Gap Monitoring

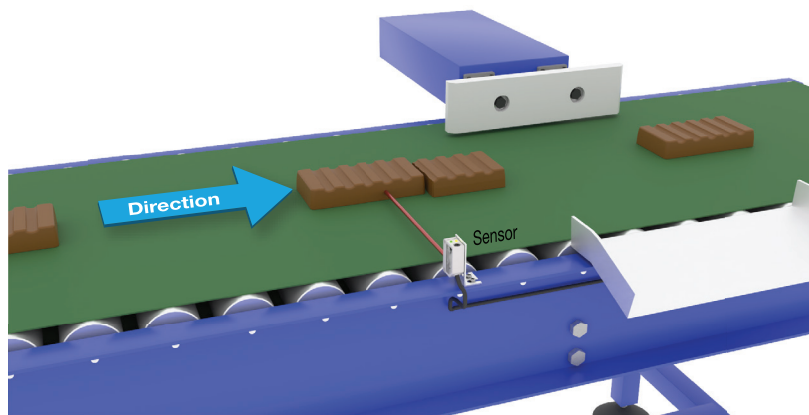

|                             |  |  |
|-----------------------------|--|--|
| <b>Function description</b> | This function is designed to monitor, that the length of an object and the gap between the following object on a conveyer belt, are within certain limits.               |  |
| <b>Conditions</b>           | Only one sensor is needed for this function.   |  |
| <b>Settings</b>             | An acceptable minimum and maximum time [ms] must be set for both the object size and a gap size between two objects represented by the time it takes to pass the sensor. |  |
|                             | Object minimum time.   | 10...60 000 ms<br><b>Factory settings: 500 ms</b>    |
|                             | Object maximum time.   | 10...60 000 ms<br><b>Factory settings: 10 000 ms</b> |
|                             | Gap minimum time.  | 10...60 000 ms<br><b>Factory settings: 500 ms</b>    |
|                             | Gap maximum time.  | 10...60 000 ms<br><b>Factory settings: 10 000 ms</b> |
| <b>Outputs</b>              | Output 1 is active when an object is outside the set limits.<br>Output 2 is active when the gap between two objects is outside the set limits.                           |  |

**Alarm settings**

|                          |   |  |
|--------------------------|---|--|
| <b>Safe limits</b>       | <b>SSC1</b><br>• 0 ... 100 % of actual SP<br><b>Factory settings: 1%</b>  | <b>SSC2</b><br>• 0 ... 100 % of actual SP<br><b>Factory settings: 1%</b> |
| <b>Dust alarm</b>        | Safe limits are used for dust alarm level.  |  |
| <b>Temperature alarm</b> | • High threshold -50 ... +150 °C<br>• Low threshold -50 ... +150 °C<br><b>Factory settings:</b><br>High value 60 °C<br>Low value -20 °C |  |

**Detection diagram**

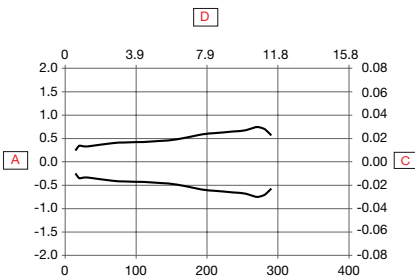

**Fig. 4 Fast mode**

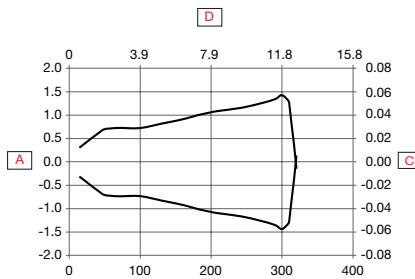

**Fig. 5 Precise mode**

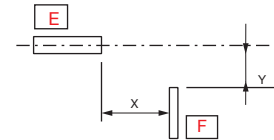

|          |                          |          |                              |
|----------|--------------------------|----------|------------------------------|
| <b>A</b> | Detection width (mm)     | <b>D</b> | Sensing range (inches)       |
| <b>B</b> | Sensing range (mm)       | <b>E</b> | Sensor                       |
| <b>C</b> | Detection width (inches) | <b>F</b> | Object 25 x 25 mm, White 90% |

**Accuracy**

|                          |                    |
|--------------------------|--------------------|
| <b>Temperature drift</b> | ≤ 0.1%/°C @ 300 mm |
|--------------------------|--------------------|

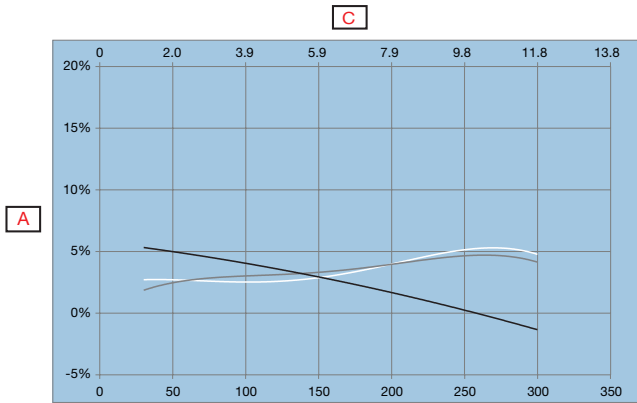

**Sensing conditions**

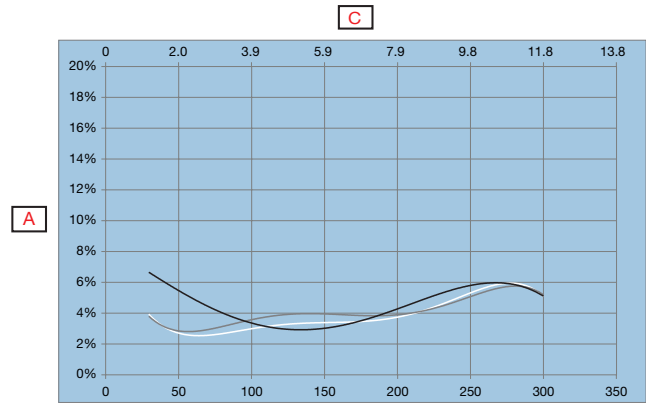

**Fig. 6 Fast mode**



**Fig. 7 Precise mode**

|          |   |   |                          |
|----------|---|---|--------------------------|
| <b>A</b> | Distance from background (%)              |    | (Black on white 6%/90%)  |
| <b>B</b> | Distance on white background 90% (mm)     |    | (Grey on white 18%/90%)  |
| <b>C</b> | Distance on white background 90% (inches] |  | (White on white 90%/90%) |

## Features

### Power Supply

|                                     |  |
|-------------------------------------|--|
| Rated operational voltage ( $U_B$ ) | 10 ... 30 VDC (ripple included)                        |
| Ripple ( $U_{rpp}$ )                | $\leq 10\%$  |
| No load supply current ( $I_o$ )    | $\leq 30$ mA @ $U_B$ min.<br>$\leq 15$ mA @ $U_B$ max. |
| Power-ON delay ( $t_v$ )            | $\leq 150$ ms  |

### Input selector

|                |  |  |
|----------------|--|--|
| Input selector | <b>Channel A</b> <ul style="list-style-type: none"> <li>• Deactivated</li> <li>• SSC1</li> <li>• SSC2</li> <li>• Dust alarm 1</li> <li>• Dust alarm 2</li> <li>• Temperature alarm</li> <li>• External input</li> <li>• Application functions</li> </ul> <b>Factory settings: SSC1</b> | <b>Channel B</b> <ul style="list-style-type: none"> <li>• Deactivated</li> <li>• SSC1</li> <li>• SSC2</li> <li>• Dust alarm 1</li> <li>• Dust alarm 2</li> <li>• Temperature alarm</li> <li>• External input</li> <li>• Application functions</li> </ul> <b>Factory settings: SSC1</b> |
|----------------|--|--|

### Logic functions

|                 |   |   |
|-----------------|---|---|
| Logic functions | <b>Channel A + B for SO1</b> <ul style="list-style-type: none"> <li>• Direct</li> <li>• AND</li> <li>• OR</li> <li>• X-OR</li> <li>• SR-FF</li> </ul> <b>Factory settings: Direct</b> | <b>Channel A + B for SO2</b> <ul style="list-style-type: none"> <li>• Direct</li> <li>• AND</li> <li>• OR</li> <li>• X-OR</li> <li>• SR-FF</li> </ul> <b>Factory settings: Direct</b> |
|-----------------|---|---|

**Time delays**

|                    |   |   |
|--------------------|---|---|
| <b>Timer mode</b>  | <b>For SO1</b> <ul style="list-style-type: none"> <li>• Disabled</li> <li>• ON delay</li> <li>• OFF delay</li> <li>• ON delay and OFF delay</li> <li>• One-shot leading edge</li> <li>• One-shot trailing edge</li> </ul> <b>Factory settings: Disabled</b> | <b>For SO2</b> <ul style="list-style-type: none"> <li>• Disabled</li> <li>• ON delay</li> <li>• OFF delay</li> <li>• ON delay and OFF delay</li> <li>• One-shot leading edge</li> <li>• One-shot trailing edge</li> </ul> <b>Factory settings: Disabled</b> |
| <b>Timer scale</b> | <b>For SO1</b> <ul style="list-style-type: none"> <li>• [ms]</li> <li>• [s]</li> <li>• [min]</li> </ul> <b>Factory settings: ms</b>   | <b>For SO2</b> <ul style="list-style-type: none"> <li>• [ms]</li> <li>• [s]</li> <li>• [min]</li> </ul> <b>Factory settings: ms</b>   |
| <b>Timer value</b> | <b>For SO1</b> <ul style="list-style-type: none"> <li>• 0 ... 32 767</li> </ul> <b>Factory settings: 0</b>  | <b>For SO2</b> <ul style="list-style-type: none"> <li>• 0 ... 32 767</li> </ul> <b>Factory settings: 0</b>  |



**Outputs**

|  |   |   |
|--|---|---|
| <b>Sensor output</b>                               | <b>For SO1 Pin 4 Black wire</b> <ul style="list-style-type: none"> <li>• Disabled output</li> <li>• NPN</li> <li>• PNP</li> <li>• Push-Pull</li> </ul> <b>Factory settings: PNP</b> | <b>For SO2 Pin 2 White wire</b> <ul style="list-style-type: none"> <li>• Disabled output</li> <li>• NPN</li> <li>• PNP</li> <li>• Push-Pull</li> <li>• External input, active high</li> <li>• External input, active low</li> <li>• External teach (Teach-in)</li> </ul> <b>Factory settings: PNP</b> |
| <b>Output Inverter</b>                             | <b>For SO1 Pin 4 Black wire</b> <ul style="list-style-type: none"> <li>• N.O.</li> <li>• N.C.</li> </ul> <b>Factory settings: N.O.</b>  | <b>For SO2 Pin 2 White wire</b> <ul style="list-style-type: none"> <li>• N.O.</li> <li>• N.C.</li> </ul> <b>Factory settings: N.C.</b>  |
| <b>Rated operational current (I<sub>o</sub>)</b>   | ≤ 100mA (continuous) pr. output<br>100 mA @ 100 nF Load (Short-time) pr. output   |   |
| <b>OFF-state current (I<sub>o</sub>)</b>           | ≤ 50 μA   |   |
| <b>Minimum operational current (I<sub>m</sub>)</b> | > 0,5 mA  |   |
| <b>Voltage drop (U<sub>d</sub>)</b>                | ≤ 1.0 VDC @ 100 mA  |   |
| <b>Protection</b>                                  | Short circuit, reverse polarity, transients   |   |
| <b>Utilization category</b>                        | DC-12   | Control of resistive loads and solid-state loads with optical isolation   |
|  | DC-13   | Control of electromagnets   |
| <b>Capacitive load</b>                             | 100 nF @ 100 mA, 24 VDC   |   |

## Operation diagram

### For default factory sensor

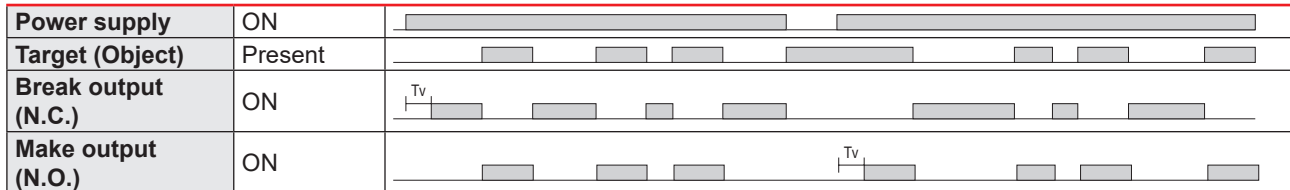
$T_v$  = Power-ON delay



## Response times

### Fast mode

|                                | Nominal detection speed |                      | Max. detection speed |                      |
|--------------------------------|-------------------------|----------------------|----------------------|----------------------|
| <b>Operating frequency (f)</b> | $\leq 500$ Hz           |                      | $\leq 650$ Hz        |                      |
| <b>Response times</b>          | $\leq 1.0$ ms           | OFF-ON ( $t_{ON}$ )  | $\leq 0.8$ ms        | OFF-ON ( $t_{ON}$ )  |
|                                | $\leq 1.0$ ms           | ON-OFF ( $t_{OFF}$ ) | $\leq 0.8$ ms        | ON-OFF ( $t_{OFF}$ ) |

### Precise mode

|                                | Nominal detection speed |                      | Max. detection speed |                      |
|--------------------------------|-------------------------|----------------------|----------------------|----------------------|
| <b>Operating frequency (f)</b> | $\leq 150$ Hz           |                      | $\leq 175$ Hz        |                      |
| <b>Response times</b>          | $\leq 3.3$ ms           | OFF-ON ( $t_{ON}$ )  | $\leq 2.9$ ms        | OFF-ON ( $t_{ON}$ )  |
|                                | $\leq 3.3$ ms           | ON-OFF ( $t_{OFF}$ ) | $\leq 2.9$ ms        | ON-OFF ( $t_{OFF}$ ) |

**Indication**

| Green LED                                  | Yellow LED                                 | Power | Function  |
|--|--|-------|---|
| <b>SIO and IO-Link mode</b>                |  |       |   |
| ● ON                                       | ● ON                                       | ON    | ON (stable)* SSC1                                   |
| ● ON                                       | OFF  | ON    | OFF (stable)* SSC1                                  |
| OFF  | ● ON                                       | ON    | ON (Not stable) SSC1                                |
| OFF  | OFF  | OFF   | OFF (Not stable) SSC1                               |
| ● Flashing 1 Hz<br>10% dutycycle           | -  | ON    | Connected via IO-Link                               |
| -  | ● Flashing 10 Hz<br>50% dutycycle          | ON    | Output short-circuit                                |
| -  | ● Flashing<br>0.5...20 Hz<br>50% dutycycle | ON    | Timer triggered indication                          |
| <b>IO-Link mode only</b>                   |  |       |   |
| ● Flashing 1 HZ<br>ON 900 ms<br>OFF 100 ms | -  | -     | Sensor is in IO-Link mode and SSC1<br>is stable     |
| ● Flashing 1 HZ<br>ON 100 ms<br>OFF 900 ms | -  | -     | Sensor is in IO-Link mode and SSC1<br>is not stable |
| ● ● Flashing 2 Hz<br>50% dutycycle         |  | ON    | Find my sensor                                      |

\*See operation diagram

**LED indication**

|                                 |  |
|---------------------------------|--|
| <b>LED indication selection</b> | <ul style="list-style-type: none"> <li>• LED indication inactive</li> <li>• LED indication active</li> <li>• Find my sensor</li> </ul> <p><b>Factory settings:</b> LED indication active</p> |
|---------------------------------|--|

**Environmental**

|   |  |                             |
|---|--|-----------------------------|
| <b>Ambient temperature</b>                      | -25°... +50°C (-13°... +122°F)                   | Operating <sup>1)</sup>     |
|   | -40° ... +70°C (-40° ... +158°F)                 | Storage <sup>1)</sup>       |
| <b>Ambient humidity range</b>                   | 35% ... 95%                                      | Operating <sup>2)</sup>     |
|   | 35% ... 95%                                      | Storage <sup>2)</sup>       |
| <b>Ambient light</b>                            | ≤ 5 000 lux                                      | @ 3000 ... 3200 °K          |
| <b>Vibration</b>                                | 10 ...150 Hz, 1.0 mm/15 g                        | EN 60068-2-6                |
| <b>Shock</b>                                    | 30 g <sub>n</sub> / 11 ms, 3 pos, 3 neg per axis | EN60068-2-27                |
| <b>Drop test</b>                                | 2 x 1 m and 100 x 0.5 m                          | EN 60068-2-31               |
| <b>Rated insulation voltage (U<sub>i</sub>)</b> | 50 VDC   |                             |
| <b>Dielectric insulation voltage</b>            | ≥ 500 VAC rms                                    | 50/60 Hz for 1 min.         |
| <b>Rated impulse withstand voltage</b>          | >1 kV (with 500 Ω)                               | 1.2/50 μs                   |
| <b>Pollution degree</b>                         | 3  | IEC60664, 60664A; EN60947-1 |
| <b>Overvoltage category</b>                     | III  | IEC60664; EN60947-1         |
| <b>Degree of protection</b>                     | IP67, IP68 @ 2 m and 20 h                        | IEC60539; EN60947-1         |
|   | IP69K  | DIN 40050-9                 |
| <b>NEMA Enclosure Types</b>                     | 1, 2, 4, 4x, 5, 6, 6P                            | NEMA 250                    |

<sup>1)</sup> Do not bend the cable in temperatures below -10°C

<sup>2)</sup> With no icing or condensation

**EMC**

|   |  |                          |
|---|--|--------------------------|
| <b>Electrostatic discharge immunity test</b>        | ± 8 kV @ air discharge or<br>± 4 kV @ contact discharge              | IEC 61000-4-2; EN60947-1 |
| <b>Electromagnetic field immunity</b>               | 10 V/m   | IEC 61000-4-3; EN60947-1 |
| <b>Fast transient immunity</b>                      | ±2 kV / 5 kHz  | IEC 61000-4-4; EN60947-1 |
| <b>Wire-conducted noise</b>                         | 10 Vrms  | IEC 61000-4-6; EN60947-1 |
| <b>Power frequency magnetic field immunity test</b> | Continuous: >30 A/m, 28 μ tesla<br>Short-time: >300 A/m, 280 μ tesla | IEC 61000-4-8; EN60947-1 |

**Diagnostic parameters**

| Function                                  | Unit  | Range               |
|---|---|---------------------|
| <b>Sensor Diagnostics</b>                 |   |                     |
| Frontend Failure                          | 0   | 0 or 1              |
| Memory Failure                            | 0   | 0 or 1              |
| <b>Temperature Diagnostics</b>            |   |                     |
| Current temperature                       | [°C]  | -50 ... +150        |
| Maximum temperature - All time high       | [°C]  | -50 ... +150        |
| Minimum temperature - All time low        | [°C]  | -50 ... +150        |
| Maximum temperature - Since last power-up | [°C]  | -50 ... +150        |
| Minimum temperature - Since last power-up | [°C]  | -50 ... +150        |
| Minutes above Maximum Temperature         | [min]   | 0 ... 2 147 483 647 |
| Minutes below Minimum Temperature         | [min]   | 0 ... 2 147 483 647 |
| <b>Operating Diagnostic</b>               |   |                     |
| Operating Hours                           | [h]   | 0 ... 2 147 483 647 |
| Number of Power Cycles                    | [cycles]  | 0 ... 2 147 483 647 |
| Detection counter SSC1                    | [cycles]  | 0 ... 2 147 483 647 |
| Maintenance event counter                 | [cycles]  | 0 ... 2 147 483 647 |
| Download counter                          | [counts]  | 0 ...65 536         |
| Quality of Teach                          | -   | 0 ... 255%          |
| Quality of Run                            | -   | 0 ... 255%          |
| Excess gain                               |   | 0.00 ... 1 000.00   |
| <b>Dual Detection</b>                     |   |                     |
| - Distance match %                        | [%]   | 0 ... 100           |
| - Excess gain match %                     | [%]   | 0 ... 100           |
| - Match %                                 | [%]   | 0 ... 100           |
| - Background detected                     | 0 = No background detected<br>1 = Background detected<br><b>Factory settings: 0</b>   |                     |
| Error Count                               | [counts]  | 0 ...65 536         |
| Device Status                             | 0 = Device is operating properly<br>1 = Maintenance required<br>2 = Out-of-specification<br>3 = Functional-Check<br>4 = Failure<br><b>Factory settings: 0</b> |                     |

**Events Configuration**

| Events                  | Factory default setting |
|-------------------------|-------------------------|
| Maintenance Event       | Inactive                |
| Temperature fault event | Inactive                |
| Temperature over-run    | Inactive                |
| Temperature under-run   | Inactive                |
| Short circuit           | Inactive                |

**Observation menu**

| Process Data                         | Factory default setting                       |
|--------------------------------------|---|
| Analogue value                       | Analogue value Inactive                       |
|                                      | Analogue value normal <b>Factory settings</b> |
|                                      | Analogue value as Object Length               |
|                                      | Analogue value as Object Speed                |
|                                      | Analogue value as Counter value               |
|                                      | Analogue value as Dual Detection              |
| Excess gain                          | Active  |
| SO1, Switching output 1              | Active  |
| SO2, Switching output 2              | Active  |
| SSC1, Sensor switching channel 1     | Inactive                                      |
| SSC2, Sensor switching channel 2     | Inactive                                      |
| DA1, Dust alarm SSC1                 | Inactive                                      |
| DA2, Dust alarm SSC2                 | Inactive                                      |
| TA, Temperature alarm                | Inactive                                      |
| SC, Short circuit                    | Inactive                                      |
| AFO1, Application functions output 1 | Inactive                                      |

## Process data structure

4 Bytes, Analogue value 16 ... 31 (16 bit)

| Byte 0 | 31          | 30 | 29        | 28        | 27         | 26         | 25          | 24          |
|--------|-------------|----|-----------|-----------|------------|------------|-------------|-------------|
|        | <b>MSB</b>  | -  | -         | -         | -          | -          | -           | -           |
| Byte 1 | 23          | 22 | 21        | 20        | 19         | 18         | 17          | 16          |
|        | -           | -  | -         | -         | -          | -          | -           | <b>LSB</b>  |
| Byte 2 | 15          | 14 | 13        | 12        | 11         | 10         | 9           | 8           |
|        | -           | -  | <b>SC</b> | <b>TA</b> | <b>DA2</b> | <b>DA1</b> | <b>SSC2</b> | <b>SSC1</b> |
| Byte 3 | 7           | 6  | 5         | 4         | 3          | 2          | 1           | 0           |
|        | <b>AFO1</b> | -  | -         | -         | -          | -          | <b>SO2</b>  | <b>SO1</b>  |

## Mechanics/electronics

### Connection

|              |   |
|--------------|---|
| <b>Cable</b> | 2 m, 4-wire 4 x 0.14 mm <sup>2</sup> , Ø = 3.3 mm, PVC, Black |
| <b>Plug</b>  | M8, 4-pin, male   |

### Wiring

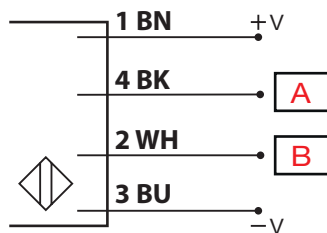

| BN    | BK    | WH    | BU   | A           | B      |
|-------|-------|-------|------|-------------|--------|
| Brown | Black | White | Blue | OUT/IO-Link | IN/OUT |

### Housing

|                     |                           |                  |
|---------------------|---------------------------|------------------|
| <b>Body</b>         | Stainless steel, AISI316L |                  |
| <b>Front glass</b>  | PMMA coated, Red          |                  |
| <b>Teach-button</b> | FKM                       | Fluoroelastomer  |
| <b>Indication</b>   | PES, Transparent          | Polyethersulfone |
| <b>Sealing</b>      | FKM                       | Fluoroelastomer  |
| <b>Cable gland</b>  | FKM                       | Fluoroelastomer  |
| <b>Dimensions</b>   | 11 x 31.5 x 21 mm         |                  |
| <b>Weight</b>       | ≤ 100 g                   | Cable version    |
|                     | ≤ 65 g                    | Plug version     |

Dimensions

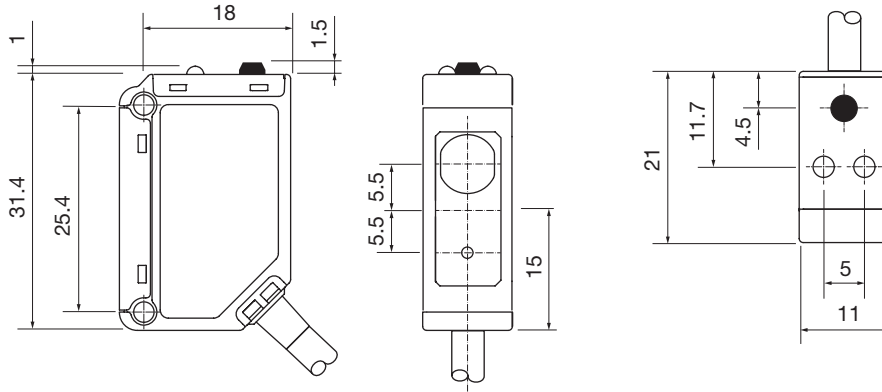

Fig. 8 Cable

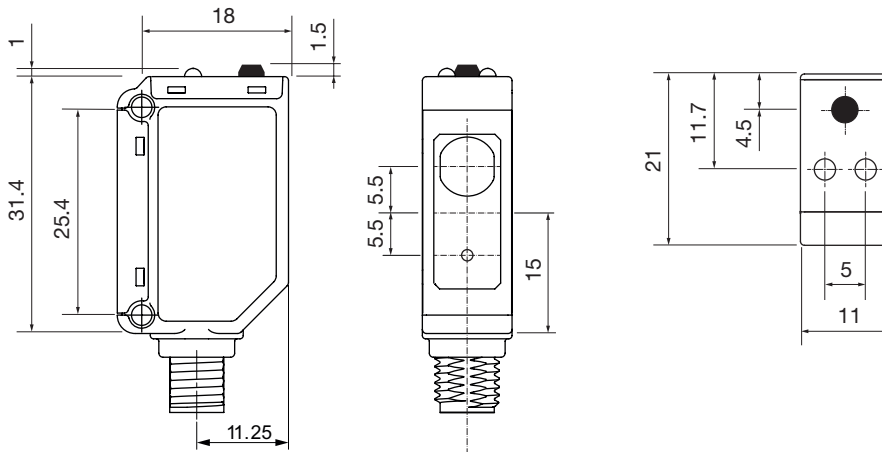



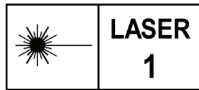

Fig. 9 Plug

## Compatibility and conformity

### Approvals and markings

|                          |  |   |
|--------------------------|--|---|
| <b>General reference</b> | Sensor designed according to EN60947-5-2   |   |
| <b>MTTF<sub>d</sub></b>  | 133.5 years  | EN ISO 13849-1, SN 29500  |
| <b>CE-marking</b>        |                                       |   |
| <b>Approvals</b>         | <br>FDA accession number: 2220061-000 |   |
| <b>Other Approvals</b>   |                                       | Topax 56, Topaz AC1, Topaz MD3, Topaz CL1, Topactiv OKTO, P3-hypochloran  |
|                          |                                      | Class 1 laser according to IEC 60825-1:2014<br>Complies with IEC / EN 60825-1:2014 and 21 CFR 1040.10 1040.11 except for deviations pursuant to Laser Notice No. 56, dated January 19, 2018 |

### IO-Link

|                               |  |
|-------------------------------|--|
| <b>IO-Link revision</b>       | 1.1  |
| <b>Transmission rate</b>      | COM2 (38.4 kbaud)                                |
| <b>SDCI-Norm</b>              | IEC 61131-9                                      |
| <b>Profile</b>                | Smart sensor profile 2nd edition, common profile |
| <b>Min. cycle time</b>        | 5 ms   |
| <b>SIO mode</b>               | Yes  |
| <b>Min. master port class</b> | A (4-pin)  |
| <b>Process data length</b>    | 32 bit   |

## Delivery contents and accessories



### Delivery contents

- Photoelectric switch: LD30EPBR30BPxxIO
- Laser safety note
- Mounting bracket: APD30-MB1
- Packaging: Carton box

### Accessories

- Mounting bracket: APD30-MB2 to be purchased separately
- Connector type: CO..54NF..W series to be purchased separately

### Further information

| Information       | Where to find it  | QR  |
|-------------------|---|---|
| IO-Link manual    | <a href="http://cga.pub/?605166">http://cga.pub/?605166</a> |  |
| Mounting brackets | <a href="http://cga.pub/?6fa29a">http://cga.pub/?6fa29a</a> |  |
| Connectors        | <a href="http://cga.pub/?3abadc">http://cga.pub/?3abadc</a> |  |



COPYRIGHT ©2023  
Content subject to change. Download the PDF: [www.gavazziautomation.com](http://www.gavazziautomation.com)