



## ANT-5GW-FPC-LH

### Flexible Embedded Cellular Sub-6 5G Antennas

The Linx ANT-5GW-FPC-LH series antennas are 120 mm x 20 mm adhesive flexible printed circuit (FPC) antennas for 5G New Radio, LTE, and cellular IoT (LTE-M, NB-IoT) applications requiring a cost-effective but capable antenna solution.

The ANT-5GW-FPC-LH antennas provide a ground plane independent dipole internal/embedded antenna solution. The flexibility and adhesive backing make the ANT-5GW-FPC-LH series easy to mount in RF transparent (e.g. plastic) enclosures, enabling environmental sealing and for protection from antenna damage.

Connection is made to the radio via a coaxial cable terminated in an MHF1/U.FL-type plug (female socket), or MHF4 plug (female socket) connector.

#### FEATURES

- Wide Bandwidth 617 MHz to 5000 MHz
- Performance at 617 MHz to 698 MHz
  - VSWR:  $\leq 1.9$
  - Peak Gain: 5.0 dBi
  - Efficiency: 76%
- Performance at 3300 MHz to 4200 MHz
  - VSWR:  $\leq 1.7$
  - Peak Gain: 6.2 dBi
  - Efficiency: 78%

#### APPLICATIONS

- Worldwide 5G/4G/3G/2G
- Cellular IoT: LTE-M (Cat-M1) and NB-IoT
- Internet of Things (IoT) devices
- Home and business networking

#### ORDERING INFORMATION

Part Number	Cable Length	Connector
ANT-5GW-FPC-LH50UF	50 mm (1.97 in)	U.FL
ANT-5GW-FPC-LH100UF	100 mm (3.94 in)	U.FL
ANT-5GW-FPC-LH150UF	150 mm (5.91 in)	U.FL
ANT-5GW-FPC-LH200UF	200 mm (7.87 in)	U.FL
ANT-5GW-FPC-LH50M4	50 mm (1.97 in)	MHF4
ANT-5GW-FPC-LH100M4	100 mm (3.94 in)	MHF4
ANT-5GW-FPC-LH150M4	150 mm (5.91 in)	MHF4
ANT-5GW-FPC-LH200M4	200 mm (7.87 in)	MHF4

Available from Linx Technologies and select distributors and representatives.

**TABLE 1. ELECTRICAL SPECIFICATIONS**

Bands	Frequency Range	VSWR (max.)	Peak Gain (dBi)	Avg. Gain (dBi)	Efficiency (%)
71	617 MHz to 698 MHz	1.9	5.0	-1.4	76
12, 13, 14, 17, 26, 28, 29, 44, 67, 68, 85, n83	698 MHz to 803 MHz	2.7	5.0	-1.6	74
5, 18, 19, 20, 26, 27, n82, n89	791 MHz to 894 MHz	2.5	5.5	-0.9	84
8, 11, 21, 32, 45, 50, 51, 74, 75, 76, n81, n91, n92, n93, n94	832 MHz to 1518 MHz	4.7	6.0	-2.2	69
24	1525 MHz to 1661 MHz	2.0	5.2	-1.8	68
1, 2, 3, 4, 9, 10, 25, 33, 34, 35, 36, 37, 39, 65, 66, 70, n80, n84, n86, n95	1695 MHz to 2200 MHz	1.7	5.1	-1.4	77
7, 30, 38, 40, 41, 53, 69, n90	2300 MHz to 2690 MHz	1.8	7.0	-0.8	86
22, 42, 43, 48, 49, 52, n77, n78	3300 MHz to 4200 MHz	1.7	6.2	-1.2	78
n79	4400 MHz to 5000 MHz	1.6	6.8	-2.0	69

Parameter	Value
Polarization	Linear
Radiation	Omnidirectional
Max Power	2 W
Wavelength	1/2-wave
Electrical Type	Dipole
Impedance	50 $\Omega$

Electrical specifications and plots measured with the antenna on a 2 mm (0.08 in) thick plastic sheet.

**TABLE 2. MECHANICAL SPECIFICATIONS**

Part Number	Connection	Coaxial Cable, minimum inside bend radius	Weight
ANT-5GW-FPC-LH50UF	MHF1/U.FL-type plug	1.13 mm: 5.0 mm (0.20 in)	1.4 g (0.05 oz)
ANT-5GW-FPC-LH100UF	MHF1/U.FL-type plug	1.13 mm: 5.0 mm (0.20 in)	1.5 g (0.05 oz)
ANT-5GW-FPC-LH150UF	MHF1/U.FL-type plug	1.13 mm: 5.0 mm (0.20 in)	1.7 g (0.06 oz)
ANT-5GW-FPC-LH200UF	MHF1/U.FL-type plug	1.13 mm: 5.0 mm (0.20 in)	1.8 g (0.06 oz)
ANT-5GW-FPC-LH50M4	MHF4-type plug	1.13 mm: 5.0 mm (0.20 in)	1.3 g (0.05 oz)
ANT-5GW-FPC-LH100M4	MHF4-type plug	1.13 mm: 5.0 mm (0.20 in)	1.5 g (0.05 oz)
ANT-5GW-FPC-LH150M4	MHF4-type plug	1.13 mm: 5.0 mm (0.20 in)	1.6 g (0.06 oz)
ANT-5GW-FPC-LH200M4	MHF4-type plug	1.13 mm: 5.0 mm (0.20 in)	1.8 g (0.06 oz)
Operating Temp. Range	-40 °C to +85 °C (-40 °F to 185 °F)		
Storage Temp. Range	-40 °C to +85 °C (-40 °F to 185 °F)		
Dimensions	120.0 mm x 20.0 mm x 0.1 mm (4.72 in x 0.79 in x 0.004 in)		

## PACKAGING INFORMATION

The ANT-5GW-FPC-LH antennas are packaged in bags of 100 pcs. Distribution channels may offer alternative packaging options.

## ANTENNA ORIENTATION

The ANT-5GW-FPC-LH antenna is a flexible, adhesive backed antenna that allows it to be permanently installed onto non-metallic surfaces. The adhesive backing is 3M 467MP™/200MP, which provides outstanding adhesion to high surface energy plastics. The adhesive delivers excellent shear strength to resist slippage and edge lifting, but can be repositioned before the adhesive cures, allowing for accurate positioning. This adhesive is highly resistant to solvents, humidity and moisture, as well as heat up to 204 °C (400 °F) for short periods.

The antenna should never be bent to the point of creating a crease or allowing the angle of the bend to fall below 90 degrees (i.e. become acute) as this will impair function and may cause permanent damage.

## PRODUCT DIMENSIONS

Figure 1 provides dimensions for the ANT-5GW-FPC-LH series antenna.

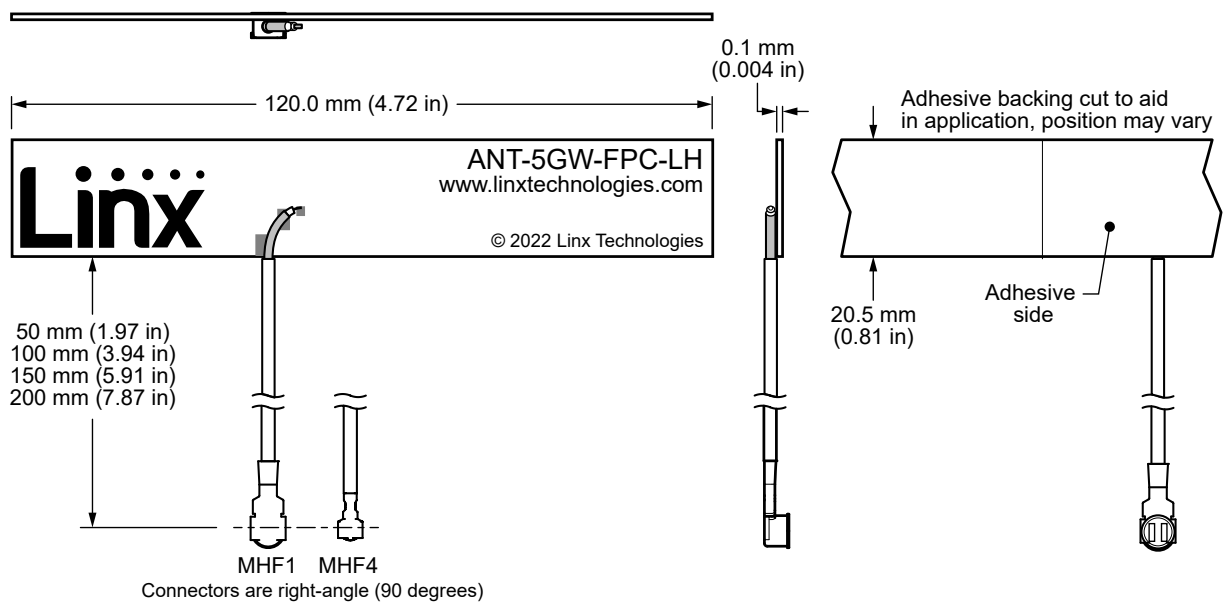

Figure 2. ANT-5GW-FPC-LH Series Antenna Dimensions

## VSWR

Figure 2 provides the voltage standing wave ratio (VSWR) across the antenna bandwidth. VSWR describes the power reflected from the antenna back to the radio. A lower VSWR value indicates better antenna performance at a given frequency. Reflected power is also shown on the right-side vertical axis as a gauge of the percentage of transmitter power reflected back from the antenna.

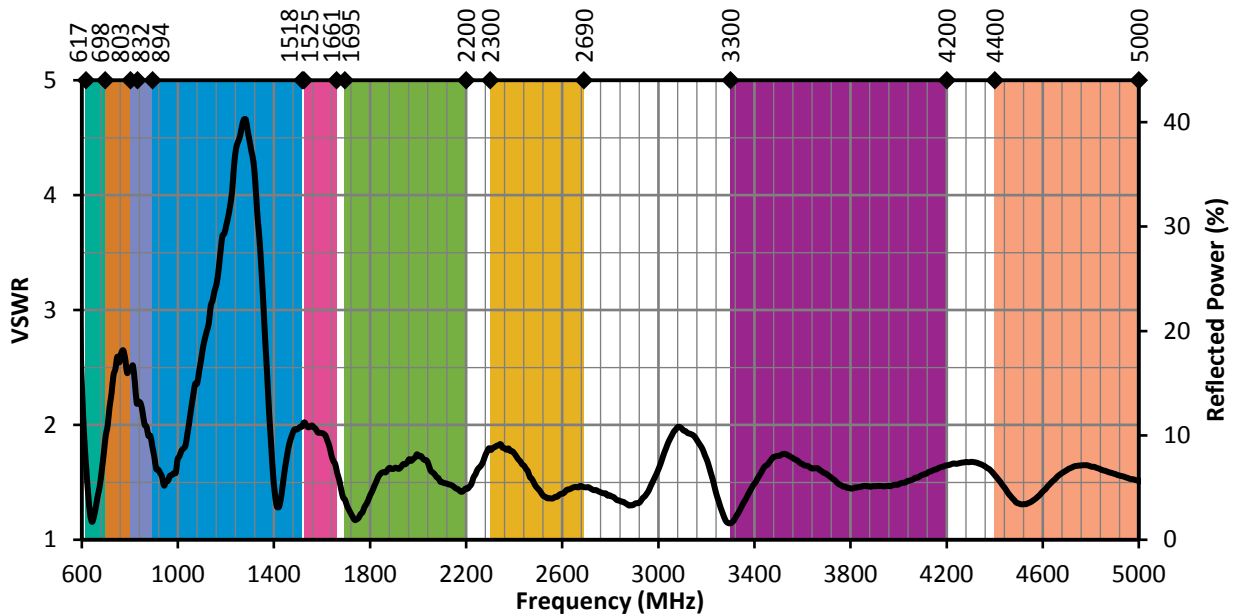

Figure 2. ANT-5GW-FPC-LH Antenna VSWR with Frequency Band Highlights

## RETURN LOSS

Return loss (Figure 3), represents the loss in power at the antenna due to reflected signals. Like VSWR, a lower return loss value indicates better antenna performance at a given frequency.

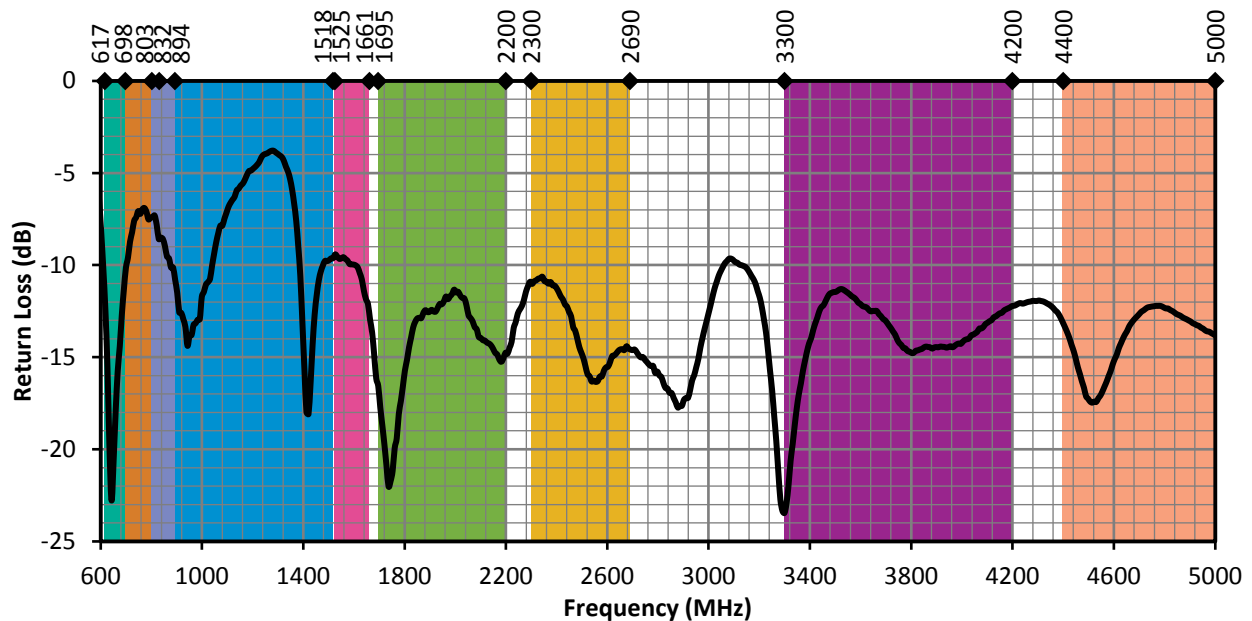

Figure 5. ANT-5GW-FPC-LH Antenna Return Loss with Frequency Band Highlights

## PEAK GAIN

The peak gain across the antenna bandwidth is shown in Figure 4. Peak gain represents the maximum antenna input power concentration across 3-dimensional space, and therefore peak performance, at a given frequency, but does not consider any directionality in the gain pattern.

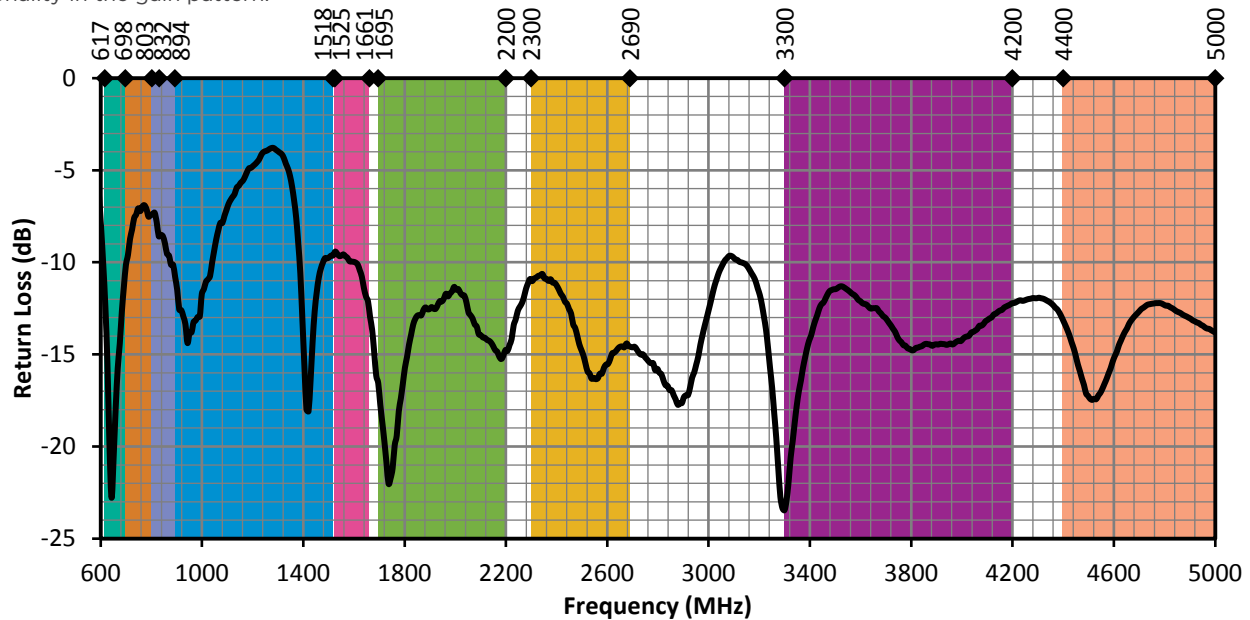

Figure 4. ANT-5GW-FPC-LH Antenna Peak Gain with Frequency Band Highlights

## AVERAGE GAIN

Average gain (Figure 5), is the average of all antenna gain in 3-dimensional space at each frequency, providing an indication of overall performance without expressing antenna directionality.

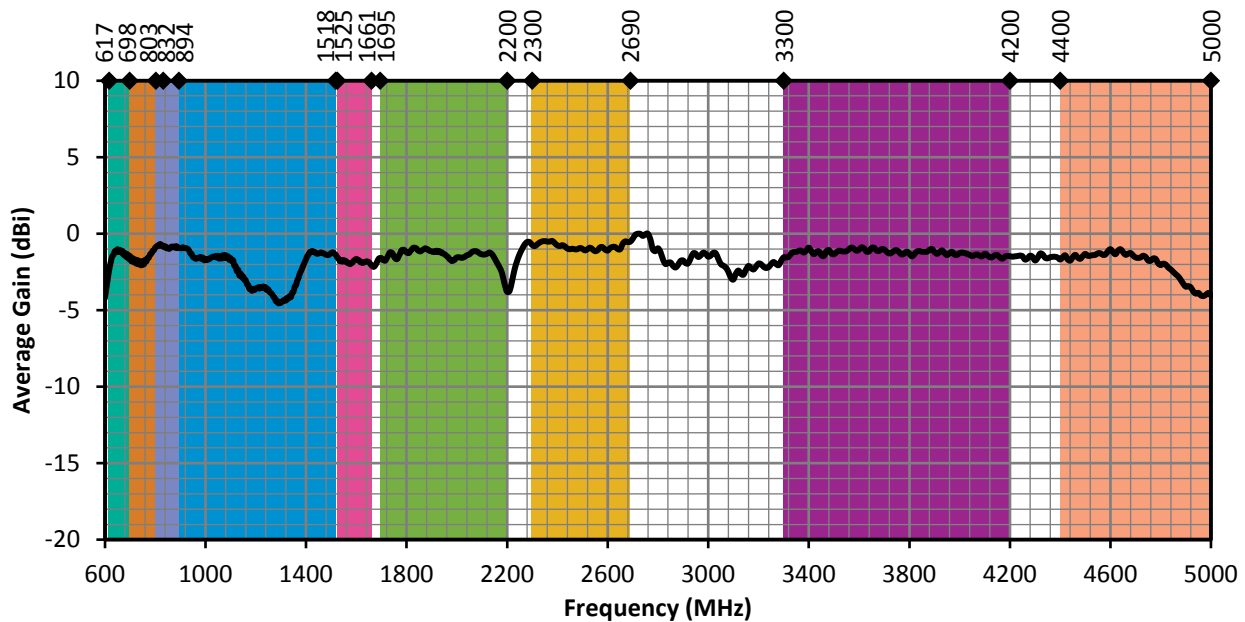

Figure 5. ANT-5GW-FPC-LH Antenna Average Gain with Frequency Band Highlights

## RADIATION EFFICIENCY

Radiation efficiency (Figure 6), shows the ratio of power delivered to the antenna relative to the power radiated at the antenna, expressed as a percentage, where a higher percentage indicates better performance at a given frequency.

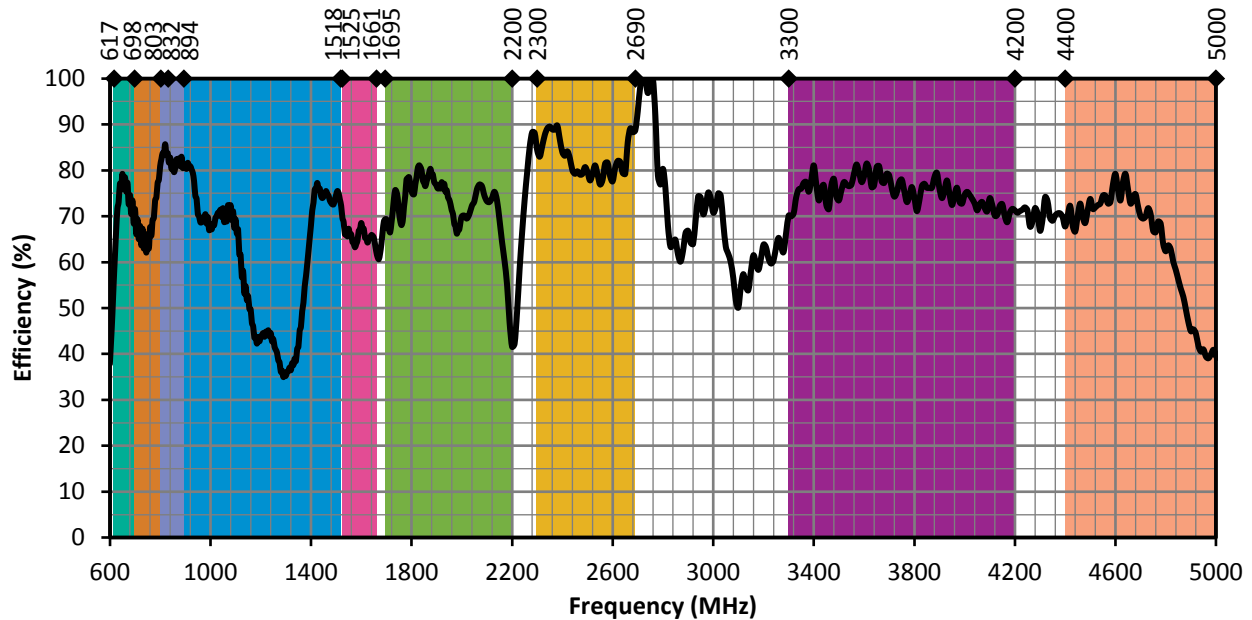
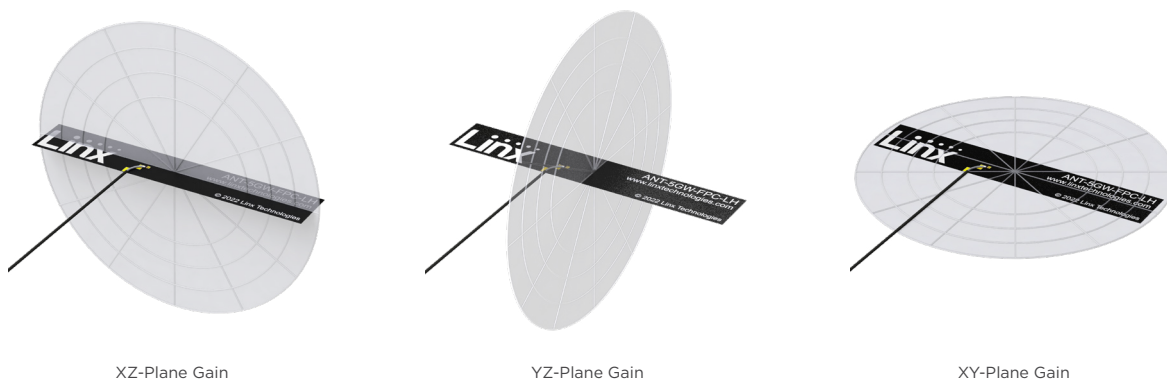

Figure 6. ANT-5GW-FPC-LH Antenna Radiation Efficiency with Frequency Band Highlights

## RADIATION PATTERNS

Radiation patterns provide information about the directionality and 3-dimensional gain performance of the antenna by plotting gain at specific frequencies in three orthogonal planes. Antenna radiation patterns (Figure 7), are shown using polar plots covering 360 degrees. The antenna graphic above the plots provides reference to the plane of the column of plots below it. Note: when viewed with typical PDF viewing software, zooming into radiation patterns is possible to reveal fine detail.

### RADIATION PATTERNS - HORIZONTAL



## 617 MHz TO 698 MHz (660 MHz)

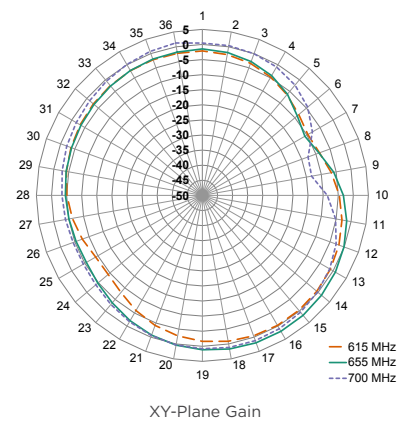
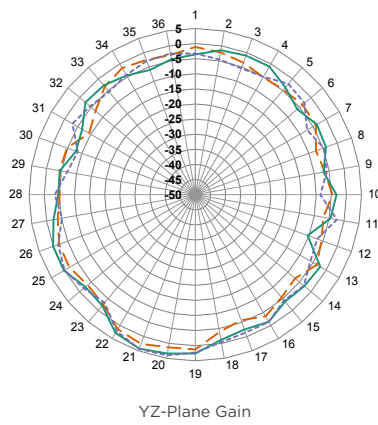
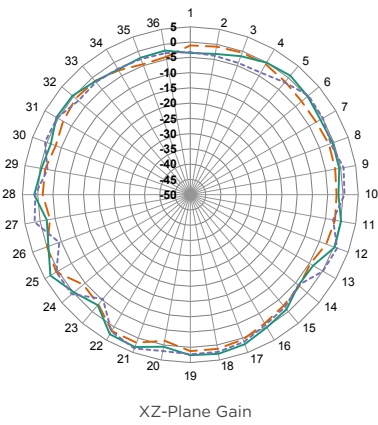

## 698 MHz TO 803 MHz (750 MHz)

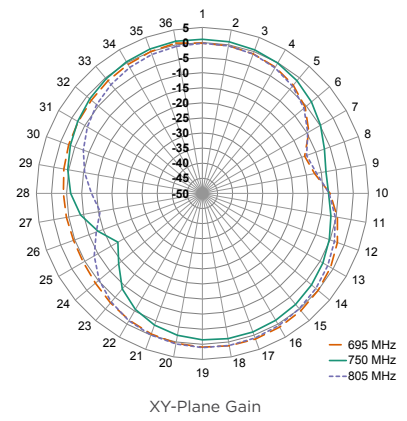
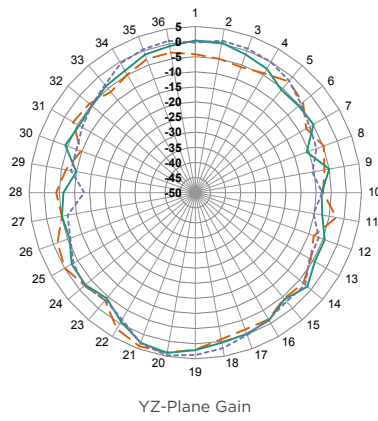
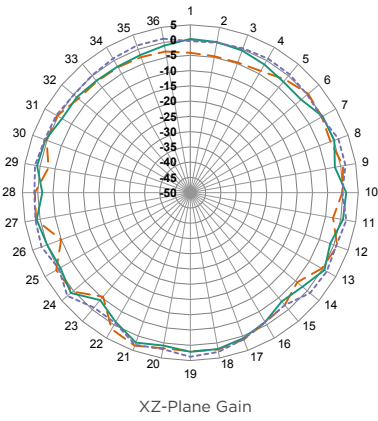

## RADIATION PATTERNS

### 791 MHz TO 894 MHz (840 MHz)

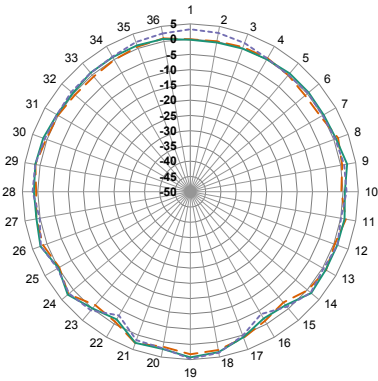

XZ-Plane Gain

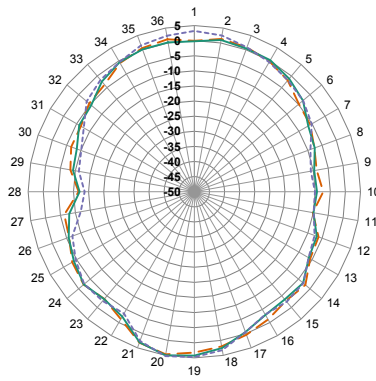

YZ-Plane Gain

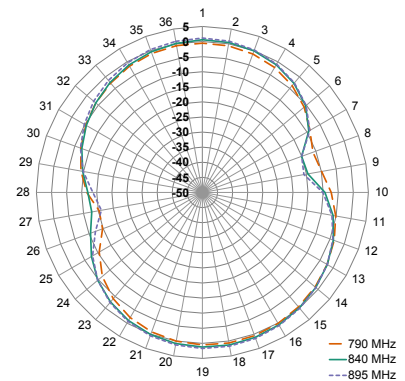

XY-Plane Gain

### 832 MHz TO 1518 MHz (1175 MHz)

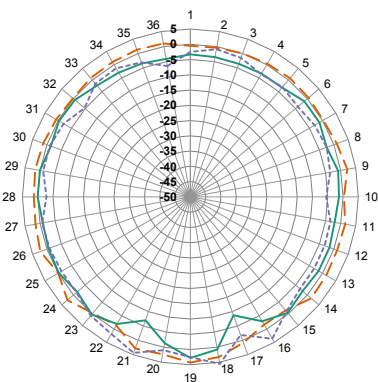

XZ-Plane Gain

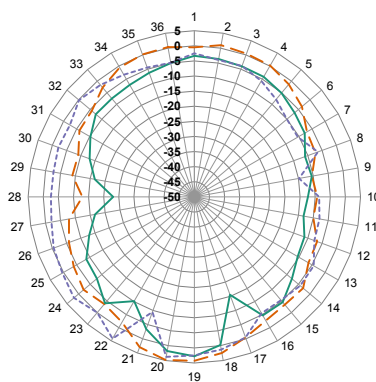

YZ-Plane Gain

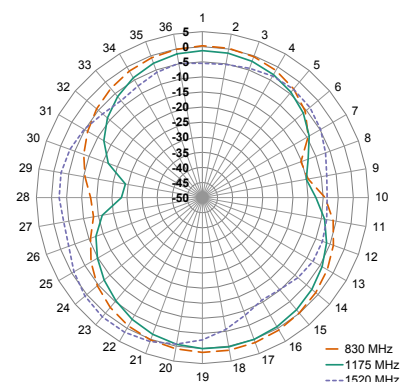

XY-Plane Gain

### 1525 MHz TO 1661 MHz (1590 MHz)

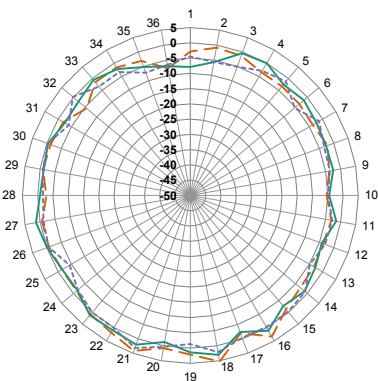

XZ-Plane Gain

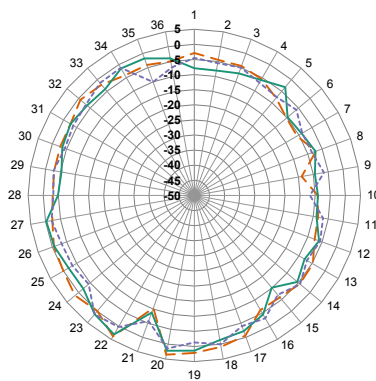

YZ-Plane Gain

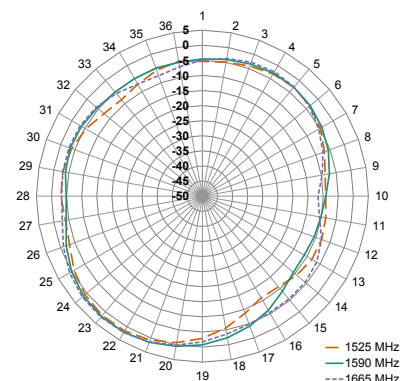

XY-Plane Gain

## RADIATION PATTERNS

### 1695 MHz TO 2200 MHz (1945 MHz)

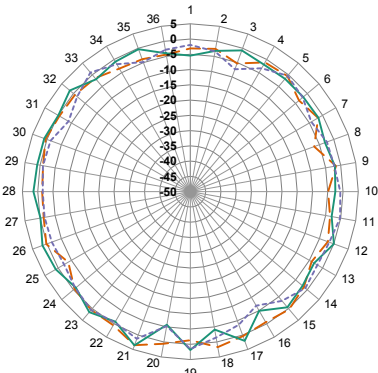

XZ-Plane Gain

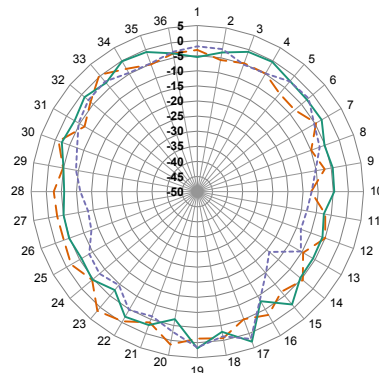

YZ-Plane Gain

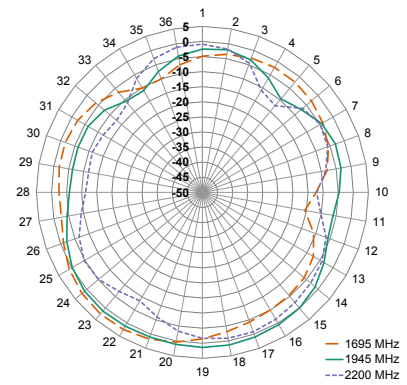

XY-Plane Gain

### 2300 MHz TO 2690 MHz (2490 MHz)

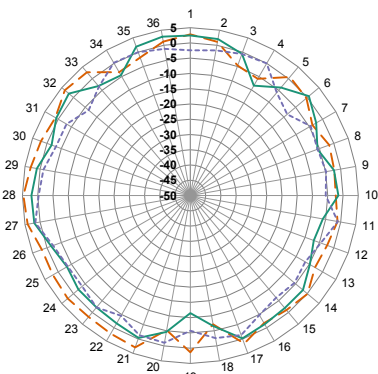

XZ-Plane Gain

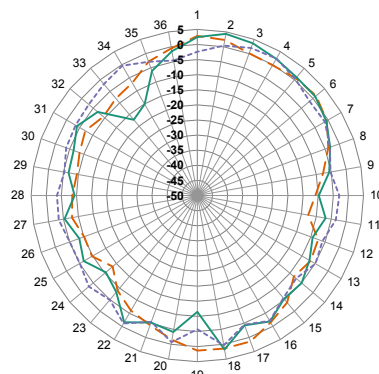

YZ-Plane Gain

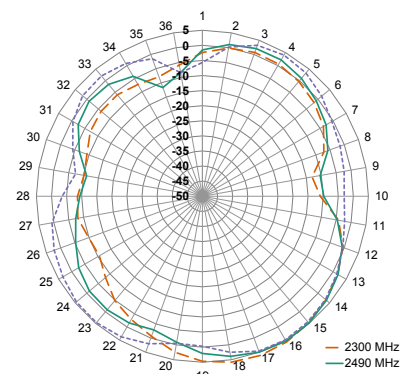

XY-Plane Gain

### 3300 MHz TO 4200 MHz (3750 MHz)

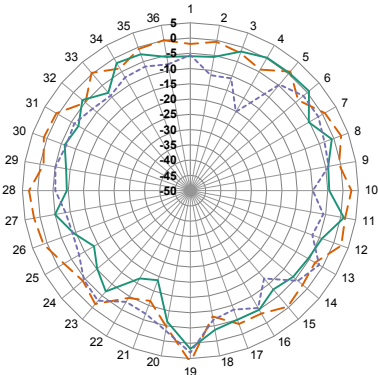

XZ-Plane Gain

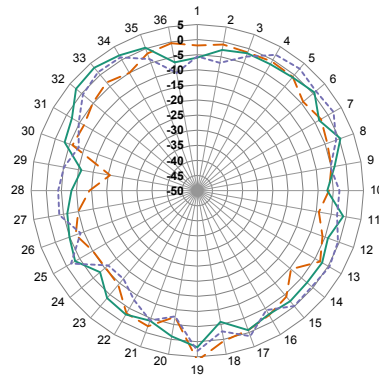

YZ-Plane Gain

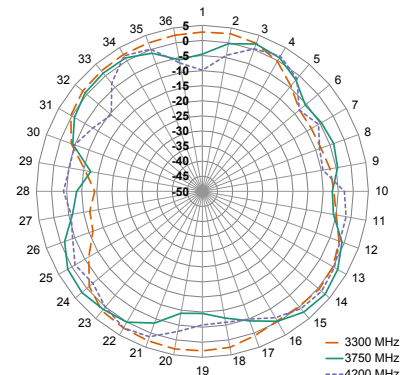

XY-Plane Gain

## RADIATION PATTERNS

### 4400 MHz TO 5000 MHz (4700 MHz)

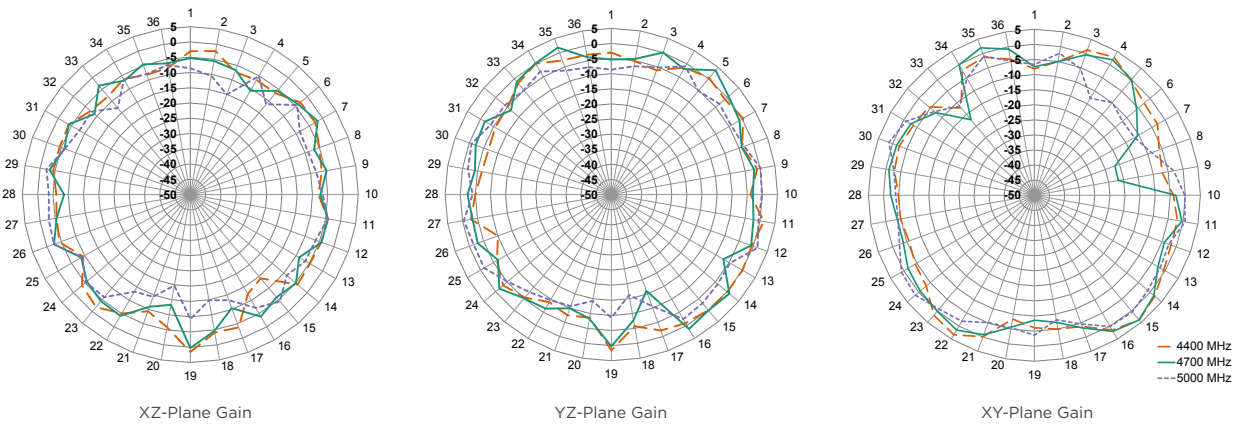

Figure 7. Radiation Patterns for ANT-5GW-FPC-LH Series Antenna

## TE TECHNICAL SUPPORT CENTER

USA:	+1 (800) 522-6752
Canada:	+1 (905) 475-6222
Mexico:	+52 (0) 55-1106-0800
Latin/S. America:	+54 (0) 11-4733-2200
Germany:	+49 (0) 6251-133-1999
UK:	+44 (0) 800-267666
France:	+33 (0) 1-3420-8686
Netherlands:	+31 (0) 73-6246-999
China:	+86 (0) 400-820-6015

## te.com

TE Connectivity, TE, TE connectivity (logo), Linx and Linx Technologies are trademarks owned or licensed by the TE Connectivity Ltd. family of companies. All other logos, products and/or company names referred to herein might be trademarks of their respective owners.

The information given herein, including drawings, illustrations and schematics which are intended for illustration purposes only, is believed to be reliable. However, TE Connectivity makes no warranties as to its accuracy or completeness and disclaims any liability in connection with its use. TE Connectivity's obligations shall only be as set forth in TE Connectivity's Standard Terms and Conditions of Sale for this product and in no case will TE Connectivity be liable for any incidental, indirect or consequential damages arising out of the sale, resale, use or misuse of the product. Users of TE Connectivity products should make their own evaluation to determine the suitability of each such product for the specific application.

TE Connectivity warrants to the original end user customer of its products that its products are free from defects in material and workmanship. Subject to conditions and limitations TE Connectivity will, at its option, either repair or replace any part of its products that prove defective because of improper workmanship or materials. This limited warranty is in force for the useful lifetime of the original end product into which the TE Connectivity product is installed. Useful lifetime of the original end product may vary but is not warranted to exceed one (1) year from the original date of the end product purchase.

©2022 TE Connectivity. All Rights Reserved.

09/22 Original