

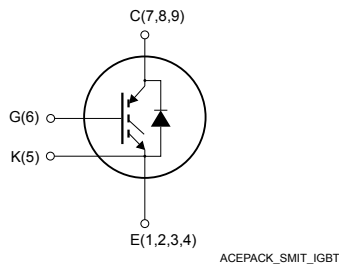

Automotive-grade trench gate field-stop, 650 V, 200 A, low-loss M series IGBT in an ACEPACK SMIT package

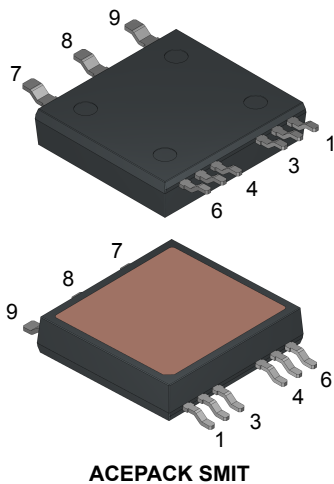

Features

- AEC-Q101 qualified 
- 6 μ s of minimum short-circuit withstand time
- $V_{CE(sat)} = 1.65$ V (typ.) @ $I_C = 200$ A
- Tight parameter distribution
- Positive $V_{CE(sat)}$ temperature coefficient
- Low thermal resistance
- Maximum junction temperature: $T_J = 175$ °C
- Dice on direct bond copper (DBC) substrate
- Isolation rating of 3400 Vrms/min
- UL recognition: UL 1557 file E81734

Applications

- Traction inverter

Description

This device is an IGBT developed using an advanced proprietary trench gate field-stop structure. The device is part of the M series IGBTs, which represent an optimal balance between inverter system performance and efficiency where the low-loss and the short-circuit functionality is essential. Furthermore, the positive $V_{CE(sat)}$ temperature coefficient and the tight parameter distribution result in safer paralleling operation. Thanks to the DBC substrate, the ACEPACK SMIT surface mounting power package offers a low thermal resistance coupled with a electrical isolated top side thermal pad.

Product status link

[STGSB200M65DF2AG](#)

Product summary

Order code	STGSB200M65DF2AG
Marking	GSB200M65DF2AG
Package	ACEPACK SMIT
Packing	Tape and reel

1 Electrical ratings

Table 1. Absolute maximum ratings

Symbol	Parameter	Value	Unit
V_{CES}	Collector-emitter voltage ($V_{GE} = 0$ V)	650	V
I_C	Continuous collector current at $T_C = 25$ °C	216 ⁽¹⁾	A
	Continuous collector current at $T_C = 100$ °C	200	
I_{CP} ⁽²⁾⁽³⁾	Pulsed collector current	700	A
V_{GE}	Gate-emitter voltage	±20	V
	Transient gate-emitter voltage ($t_p \leq 10$ μs)	±30	
I_F ⁽¹⁾	Continuous forward current at $T_C = 25$ °C	138	A
	Continuous forward current at $T_C = 100$ °C	138	
I_{FP} ⁽²⁾⁽³⁾	Pulse forward current	700	A
V_{ISO}	Isolation withstand voltage applied between each pin and heat sink plate (AC voltage 50/60 Hz, $t = 60$ s)	3400	Vrms
P_{TOT}	Total power dissipation at $T_C = 25$ °C	714	W
T_{stg}	Storage temperature range	-55 to 150	°C
T_J	Operating junction temperature range	-55 to 175	°C

1. Limited by wires.
2. Specified by design, not tested in production.
3. Pulse width is limited by maximum junction temperature.

Table 2. Thermal data

Symbol	Parameter	Value	Unit
R_{thJC}	Thermal resistance, junction-to-case, IGBT	0.21	°C/W
	Thermal resistance, junction-to-case, diode	0.36	

2 Electrical characteristics

$T_C = 25\text{ °C}$ unless otherwise specified.

Table 3. Static characteristics

Symbol	Parameter	Test conditions	Min.	Typ.	Max.	Unit
$V_{(BR)CES}$	Collector-emitter breakdown voltage	$V_{GE} = 0\text{ V}, I_C = 1\text{ mA}$	650			V
$V_{CE(sat)}$	Collector-emitter saturation voltage	$V_{GE} = 15\text{ V}, I_C = 200\text{ A}$	1.2	1.65	2.05	V
		$V_{GE} = 15\text{ V}, I_C = 200\text{ A}, T_J = 125\text{ °C}$		1.9		
		$V_{GE} = 15\text{ V}, I_C = 200\text{ A}, T_J = 175\text{ °C}$		2.1		
$V_{GE(th)}$	Gate threshold voltage	$V_{CE} = V_{GE}, I_C = 1\text{ mA}$	5	6	7	V
V_F	Forward on-voltage	$I_F = 200\text{ A}$	0.7	1.9	2.65	V
		$I_F = 200\text{ A}, T_J = 125\text{ °C}$		1.65		
		$I_F = 200\text{ A}, T_J = 175\text{ °C}$		1.55		
I_{CES}	Collector cut-off current	$V_{GE} = 0\text{ V}, V_{CE} = 650\text{ V}$			100	μA
I_{GES}	Gate-emitter leakage current	$V_{CE} = 0\text{ V}, V_{GE} = \pm 20\text{ V}$			± 600	nA

Table 4. Dynamic characteristics

Symbol	Parameter	Test conditions	Min.	Typ.	Max.	Unit
C_{ies}	Input capacitance	$V_{CE} = 25\text{ V}, f = 1\text{ MHz}, V_{GE} = 0\text{ V}$	-	16	-	nF
C_{oes}	Output capacitance		-	1	-	nF
C_{res}	Reverse transfer capacitance		-	0.3	-	nF
Q_g	Total gate charge	$V_{CC} = 520\text{ V}, I_C = 200\text{ A}, V_{GE} = 0\text{ to }15\text{ V}$ (see Figure 27. Gate charge test circuit)	-	554	-	nC
Q_{ge}	Gate-emitter charge		-	127	-	nC
Q_{gc}	Gate-collector charge		-	229	-	nC

Table 5. Switching characteristics (inductive load)

Symbol	Parameter	Test conditions	Min.	Typ.	Max.	Unit
$t_{d(on)}$	Turn-on delay time	$V_{CC} = 400\text{ V}$, $V_{GK} = -8\text{ to }15\text{ V}$, $R_G = 4.7\ \Omega$, $I_C = 200\text{ A}$ (see Figure 26. Test circuit for inductive load switching and Figure 28. Switching waveform)		122	-	ns
t_r	Current rise time			54.4	-	ns
$E_{on}^{(1)}$	Turn-on switching energy			3.82	-	mJ
$t_{d(off)}$	Turn-off delay time			250	-	ns
t_f	Current fall time			76.5	-	ns
$E_{off}^{(2)}$	Turn-off switching energy			6.97	-	mJ
$t_{d(on)}$	Turn-on delay time	$V_{CC} = 400\text{ V}$, $V_{GK} = -8\text{ to }15\text{ V}$, $R_G = 4.7\ \Omega$, $I_C = 200\text{ A}$, $T_J = 175\text{ }^\circ\text{C}$ (see Figure 26. Test circuit for inductive load switching and Figure 28. Switching waveform)		128	-	ns
t_r	Current rise time			65.6	-	ns
$E_{on}^{(1)}$	Turn-on switching energy			7.4	-	mJ
$t_{d(off)}$	Turn-off delay time			266	-	ns
t_f	Current fall time			146.6	-	ns
$E_{off}^{(2)}$	Turn-off switching energy			9.16	-	mJ
tsc	Short circuit withstand time	$V_{CC} \leq 400\text{ V}$, $V_{GE} = 15\text{ V}$, $R_G = 4.7\ \Omega$, $T_{Jstart} = 150\text{ }^\circ\text{C}$	6		-	μs

1. Including the reverse recovery of the diode.
2. Including the tail of the collector current.

Table 6. Diode switching characteristics (inductive load)

Symbol	Parameter	Test conditions	Min.	Typ.	Max.	Unit	
t_{rr}	Reverse recovery time	$I_F = 200\text{ A}$, $V_R = 400\text{ V}$, $V_{GE} = -8\text{ to }15\text{ V}$, $R_G = 4.7\ \Omega$ (see Figure 29. Diode reverse recovery waveform)	-	174.5	-	ns	
Q_{rr}	Reverse recovery charge			-	8.6	-	μC
I_{rrm}	Reverse recovery current			-	108.5	-	A
di_{rr}/dt	Peak rate of fall of reverse recovery current during t_b			-	1503	-	A/ μs
E_{rr}	Reverse recovery energy			-	2396	-	μJ
t_{rr}	Reverse recovery time	$I_F = 200\text{ A}$, $V_R = 400\text{ V}$, $V_{GE} = -8\text{ to }15\text{ V}$, $R_G = 4.7\ \Omega$, $T_J = 175\text{ }^\circ\text{C}$ (see Figure 29. Diode reverse recovery waveform)	-	264.3	-	ns	
Q_{rr}	Reverse recovery charge			-	25.5	-	μC
I_{rrm}	Reverse recovery current			-	192.2	-	A
di_{rr}/dt	Peak rate of fall of reverse recovery current during t_b			-	1247	-	A/ μs
E_{rr}	Reverse recovery energy			-	7117	-	μJ

2.1 Electrical characteristics (curves)

Figure 1. Power dissipation vs case temperature

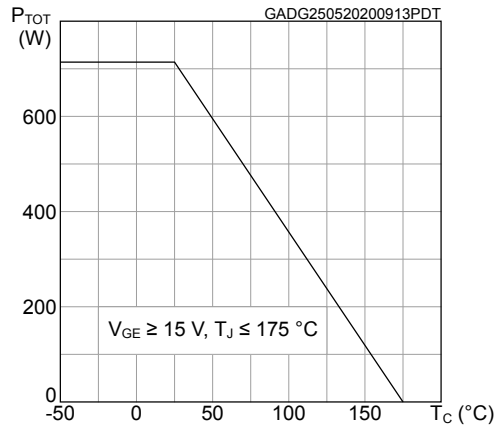

Figure 2. Collector current vs case temperature

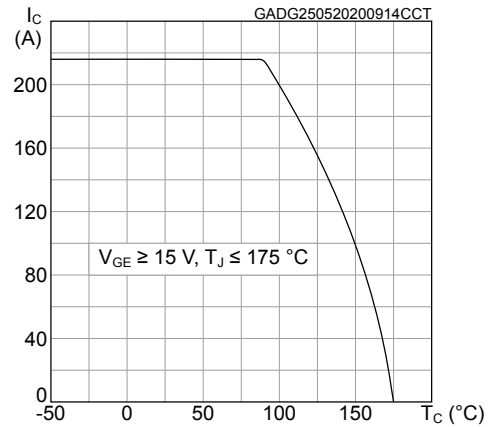

Figure 3. Output characteristics (T_J = 25 °C)

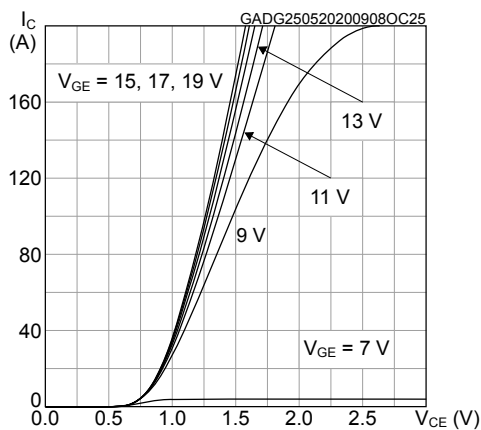

Figure 4. Output characteristics (T_J = 175 °C)

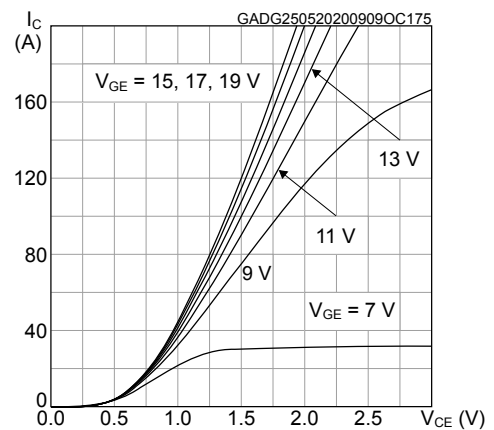

Figure 5. V_{CE(sat)} vs junction temperature

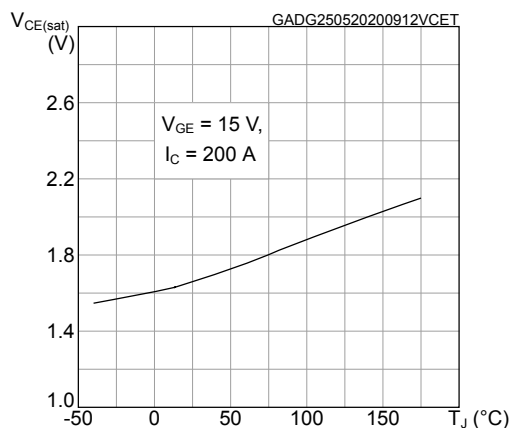

Figure 6. V_{CE(sat)} vs collector current

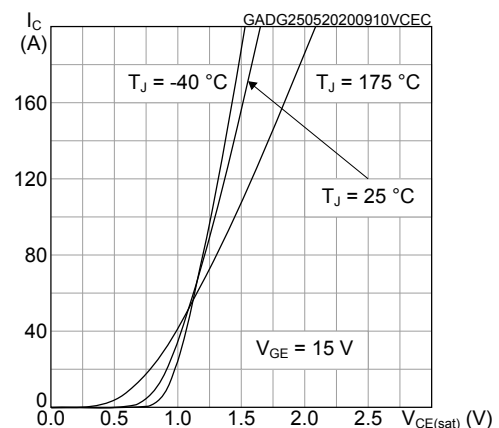

Figure 7. Collector current vs switching frequency

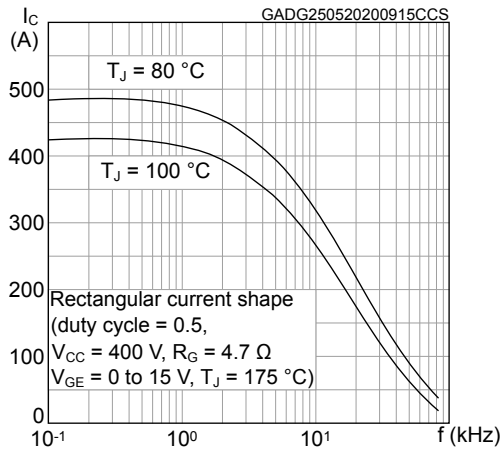

Figure 8. Forward bias safe operating area

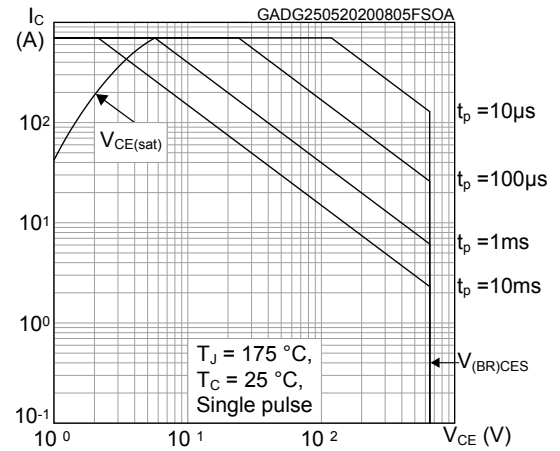

Figure 9. Transfer characteristics

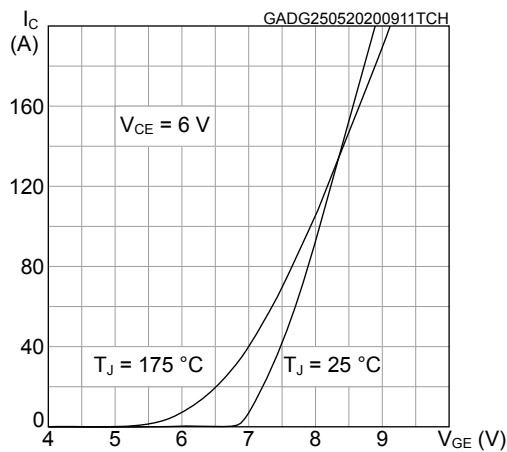

Figure 10. Diode Vf vs forward current

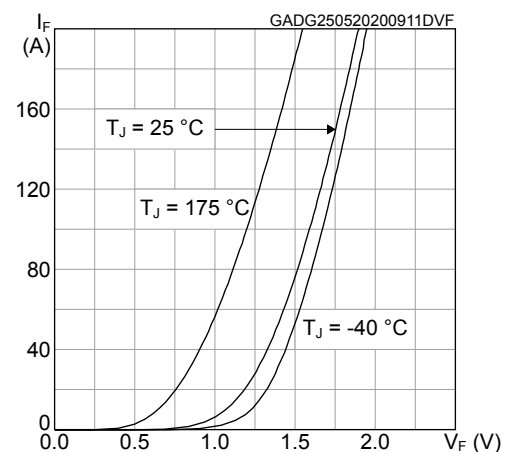

Figure 11. Normalized VGE(th) vs junction temperature

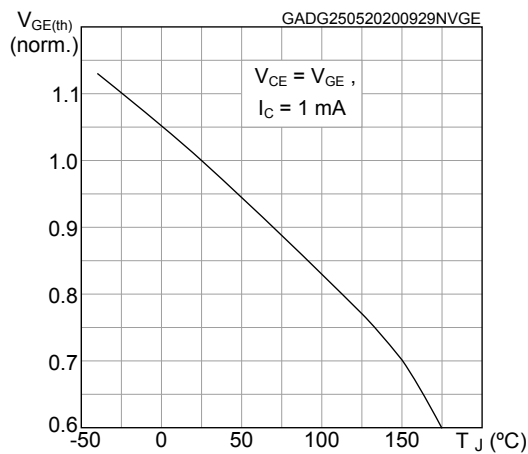

Figure 12. Normalized V(BR)CES vs junction temperature

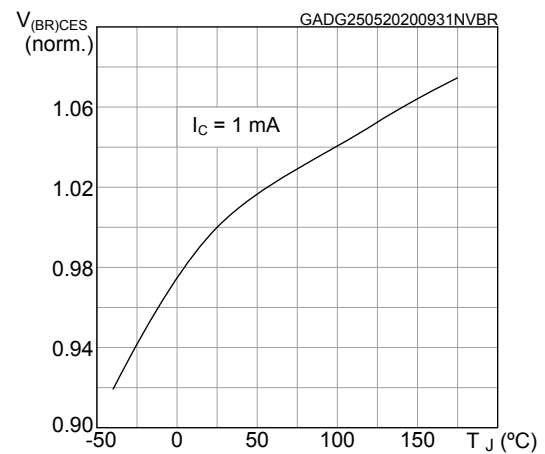

Figure 13. Capacitance variations

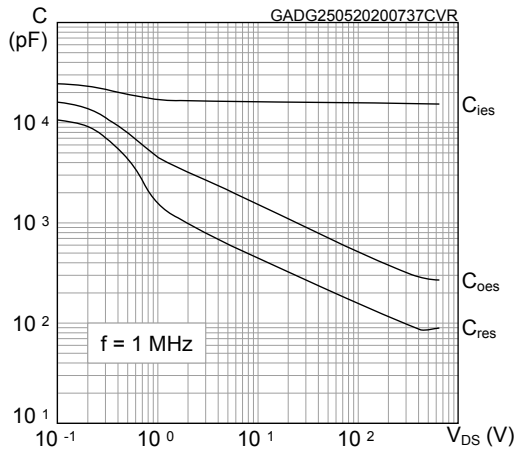

Figure 14. Gate charge vs gate-emitter voltage

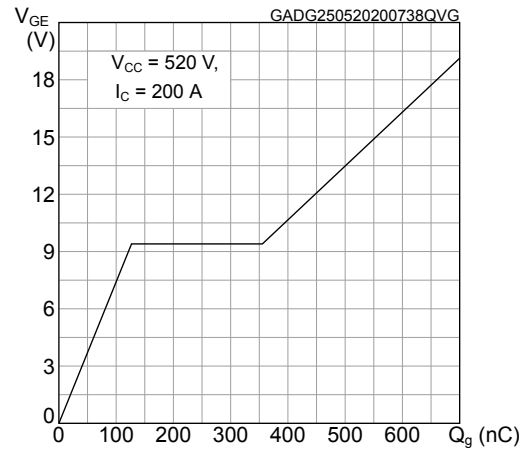

Figure 15. Switching energy vs collector current

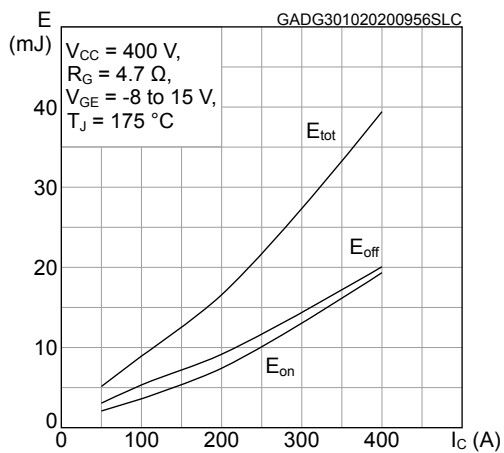

Figure 16. Switching energy vs gate resistance

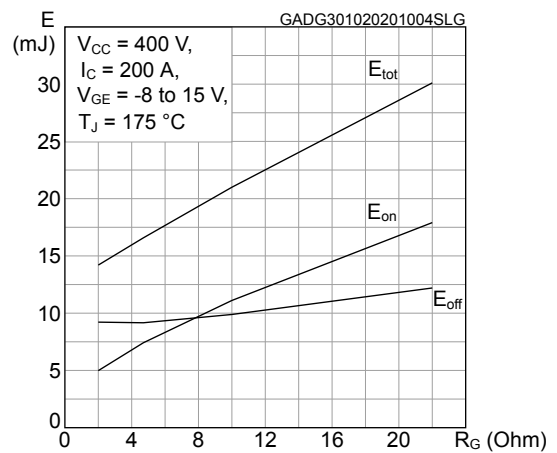

Figure 17. Switching energy vs temperature

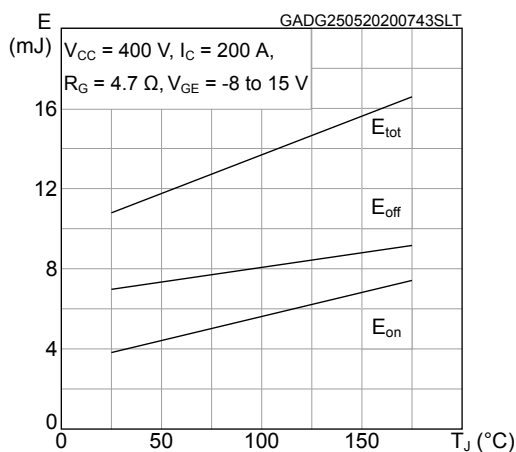

Figure 18. Switching energy vs collector emitter voltage

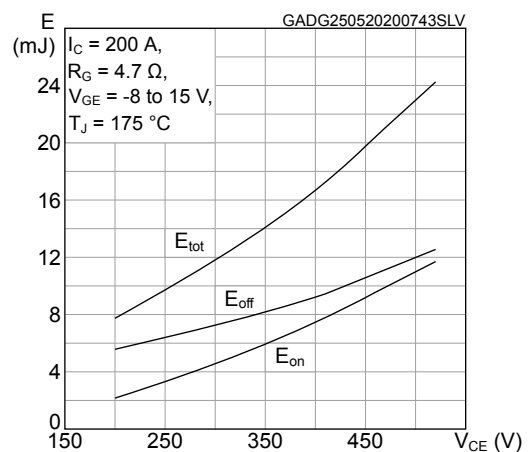

Figure 19. Switching times vs collector current

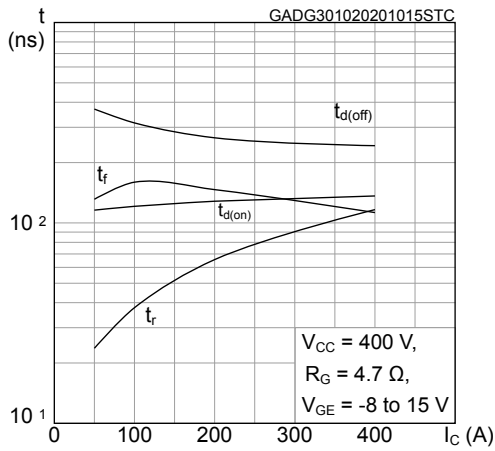

Figure 20. Switching times vs gate resistance

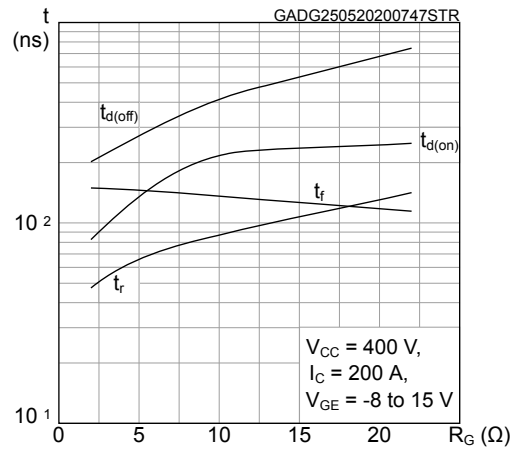

Figure 21. Reverse recovery current vs diode current slope

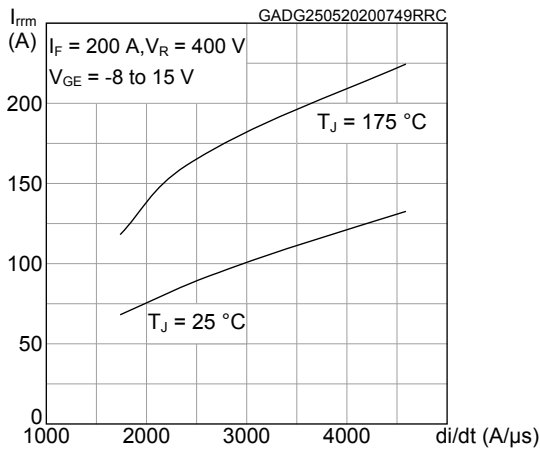

Figure 22. Reverse recovery time vs diode current slope

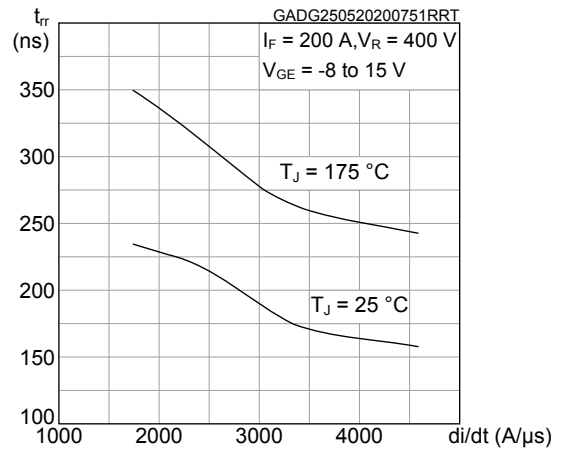

Figure 23. Reverse recovery charge vs diode current slope

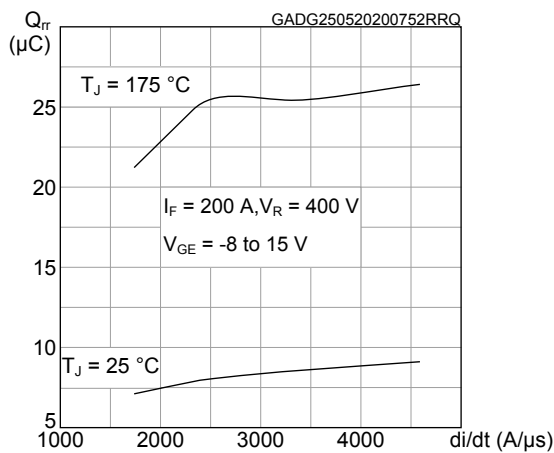

Figure 24. Reverse recovery energy vs diode current slope

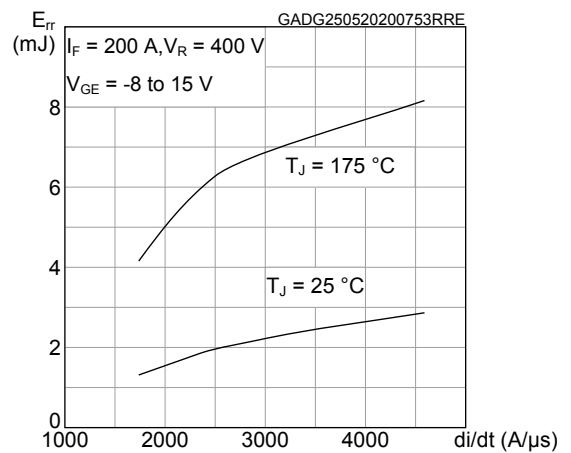
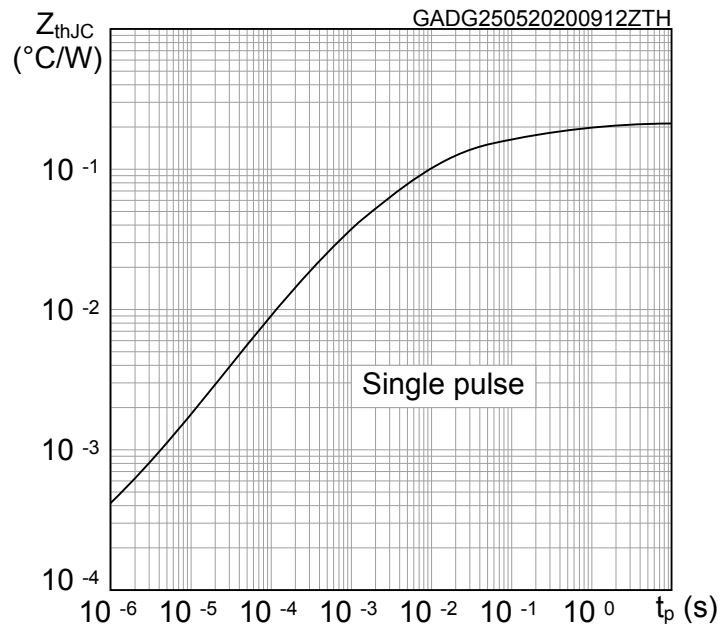
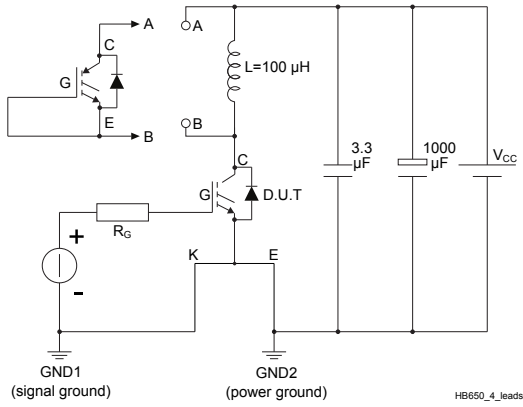
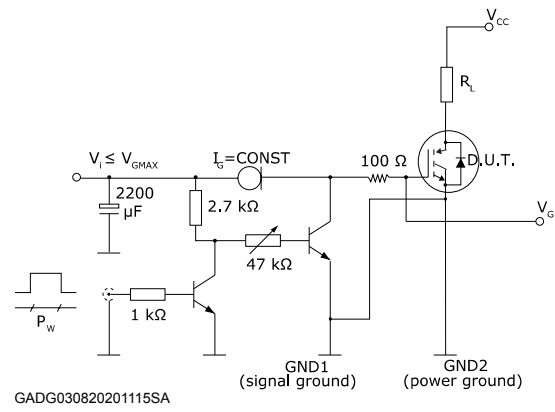
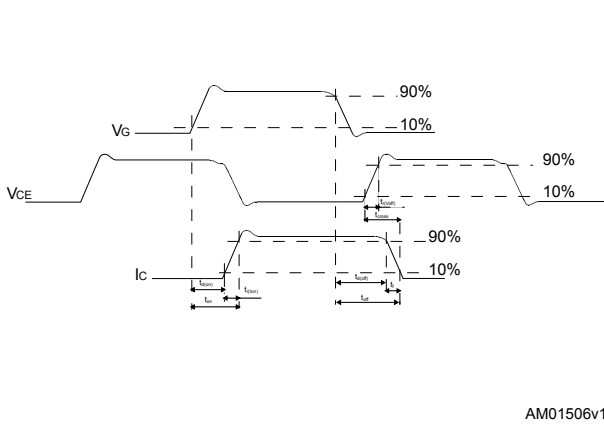
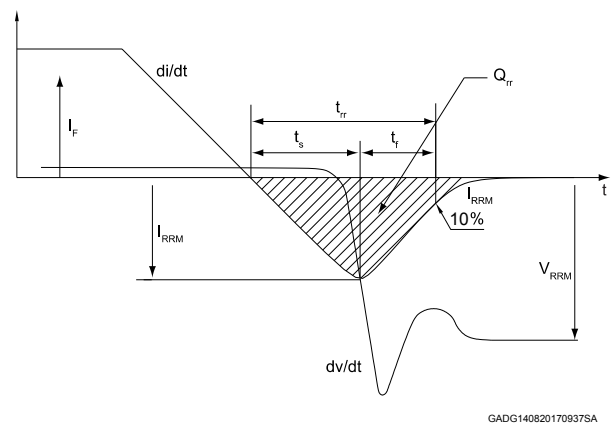

Figure 25. Maximum transient thermal impedance



3 Test circuits

Figure 26. Test circuit for inductive load switching

Figure 27. Gate charge test circuit

Figure 28. Switching waveform

Figure 29. Diode reverse recovery waveform

4 Package information

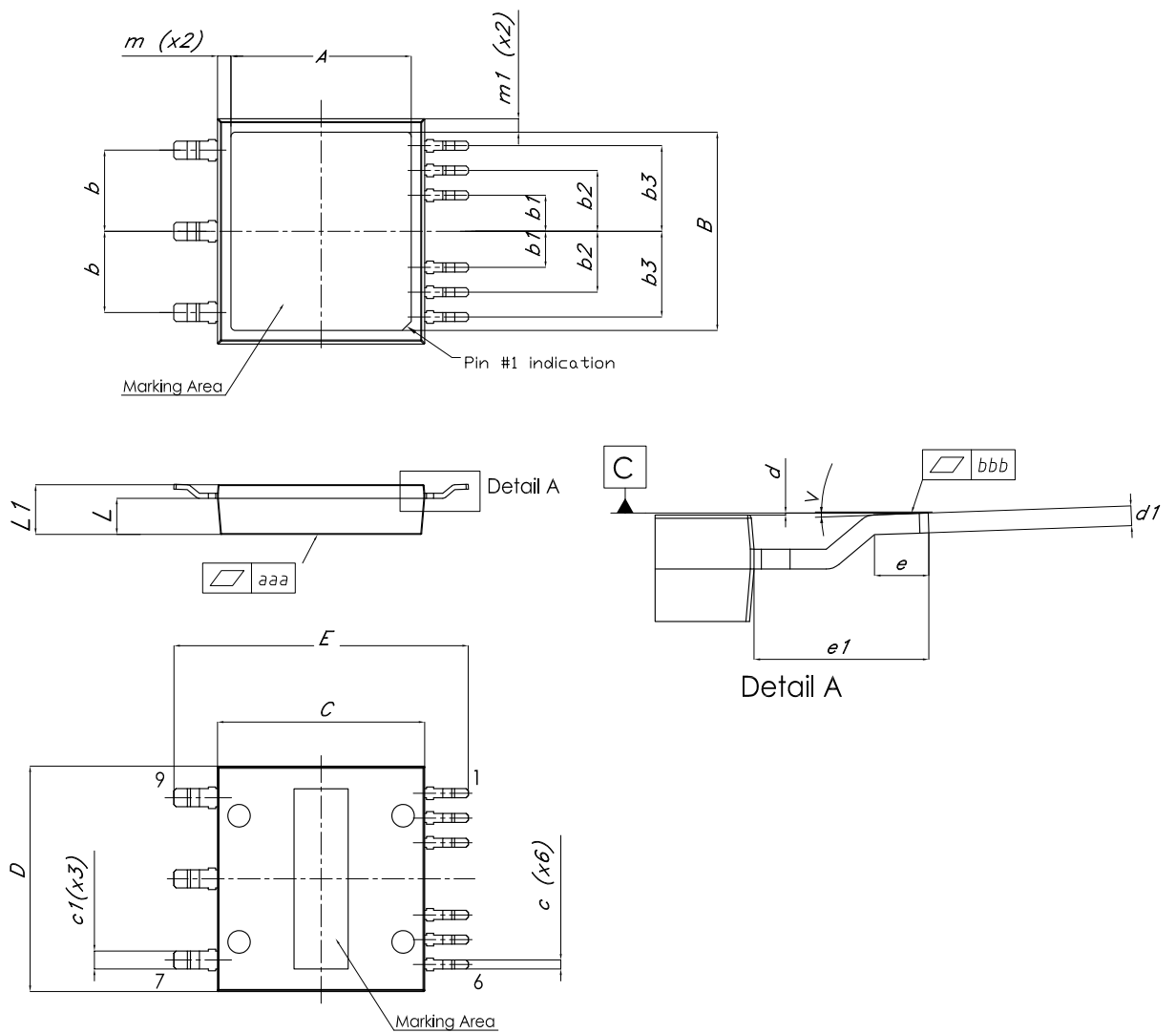
In order to meet environmental requirements, ST offers these devices in different grades of **ECOPACK** packages, depending on their level of environmental compliance. ECOPACK specifications, grade definitions and product status are available at: www.st.com. ECOPACK is an ST trademark.

4.1 ACEPACK SMIT package information

Figure 30. ACEPACK SMIT package outline



DM00447519_Rev.6

Table 7. ACEPACK SMIT package mechanical data

Dim.	mm		
	Min.	Typ.	Max.
A	19.50	20.00	20.50
B	21.50	22.00	22.50
C	22.80	23.00	23.20
D	24.80	25.00	25.20
E	32.20	32.70	33.20
b		9.00	
b1		4.00	
b2		6.75	
b3		9.50	
c	0.95	1.00	1.10
c1	1.95	2.00	2.10
d	0.00		0.15
d1	0.45	0.55	0.65
e	1.30	1.50	1.70
e1	4.65	4.85	5.05
L	3.95	4.00	4.05
L1	5.40	5.50	5.60
m	1.30	1.50	1.80
m1	1.30	1.50	1.80
V	0°	2°	4°
aaa	0.01		0.05
bbb	0.00		0.10

Figure 31. ACEPACK SMIT recommended footprint

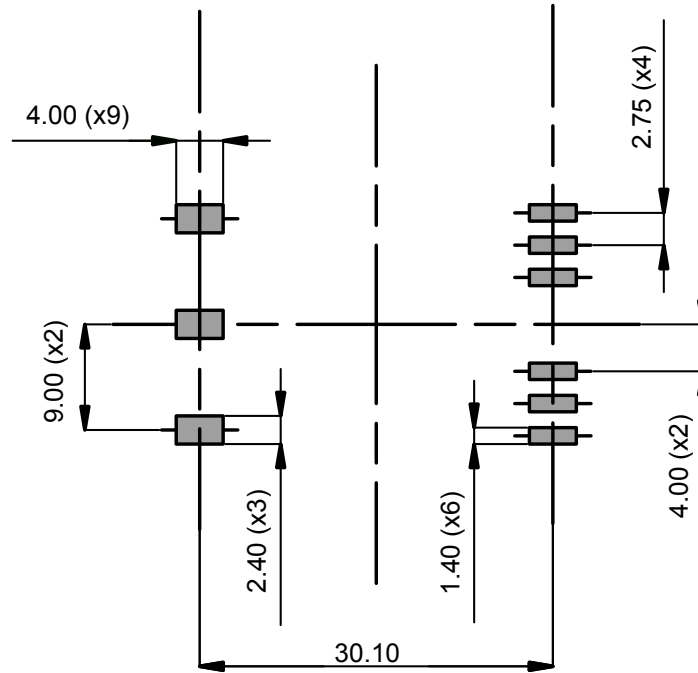

DM00447519_FP_Rev.6

Note: Dimensions in mm.

Figure 32. ACEPACK SMIT marking orientation vs pinout

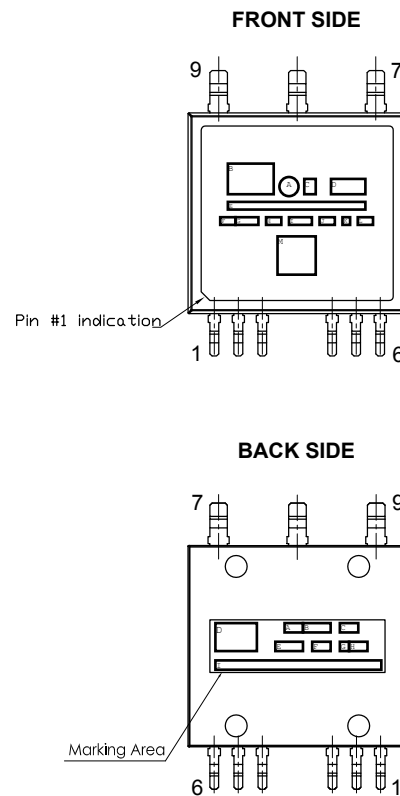

DM00447519_MO_Rev.5

Revision history

Table 8. Document revision history

Date	Revision	Changes
24-Aug-2020	1	First release.
30-Oct-2020	2	Updated package silhouette in cover page. Updated <i>Absolute maximum ratings</i> , <i>Table 2. Thermal data</i> , <i>Table 4. Dynamic characteristics</i> and <i>Table 5. Switching characteristics (inductive load)</i> . Updated <i>Figure 16. Switching energy vs gate resistance</i> and <i>Section 3 Test circuits</i> . Minor text changes.
29-Nov-2021	3	Modified <i>Table 3. Static characteristics</i> and <i>Figure 10. Diode V_F vs forward current</i> . Updated <i>Figure 31. ACEPACK SMIT recommended footprint</i> . Minor text changes.

Contents

1	Electrical ratings	2
2	Electrical characteristics	3
2.1	Electrical characteristics (curves)	5
3	Test circuits	10
4	Package information	11
4.1	ACEPACK SMIT package information	11
4.2	ACEPACK SMIT packing information	14
	Revision history	15

IMPORTANT NOTICE – PLEASE READ CAREFULLY

STMicroelectronics NV and its subsidiaries (“ST”) reserve the right to make changes, corrections, enhancements, modifications, and improvements to ST products and/or to this document at any time without notice. Purchasers should obtain the latest relevant information on ST products before placing orders. ST products are sold pursuant to ST’s terms and conditions of sale in place at the time of order acknowledgement.

Purchasers are solely responsible for the choice, selection, and use of ST products and ST assumes no liability for application assistance or the design of Purchasers’ products.

No license, express or implied, to any intellectual property right is granted by ST herein.

Resale of ST products with provisions different from the information set forth herein shall void any warranty granted by ST for such product.

ST and the ST logo are trademarks of ST. For additional information about ST trademarks, please refer to www.st.com/trademarks. All other product or service names are the property of their respective owners.

Information in this document supersedes and replaces information previously supplied in any prior versions of this document.

© 2021 STMicroelectronics – All rights reserved