

THE INFORMATION CONTAINED IN THIS DRAWING IS THE SOLE PROPERTY OF L-COM, INC. ANY REPRODUCTIONS IN PART OR WHOLE WITHOUT THE WRITTEN PERMISSION OF L-COM, INC. IS PROHIBITED.

REVISIONS			
REV	DESCRIPTION	DATE	CHANGED BY
A	INITIAL RELEASE	07/11/17	JLABOY

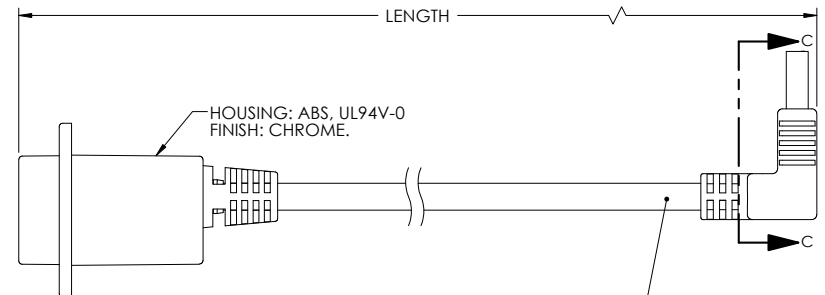

UL 20276,  
(2) SHIELDED TWISTED PAIRS, 30AWG WITH ALUMINUM MYLAR SHIELD STRANDED TINNED COPPER AND DRAIN WIRE,  
(1) UNSHIELDED TWISTED PAIR, 30AWG, STRANDED TINNED COPPER,  
(2) CONDUCTORS, 24AWG, STRANDED TINNED COPPER,  
WITH ALUM/POLY FOIL SHIELD AND OVERALL BRIAID SHIELD  
OUTER JACKET: PVC, BLUE (PANTONE 300C)

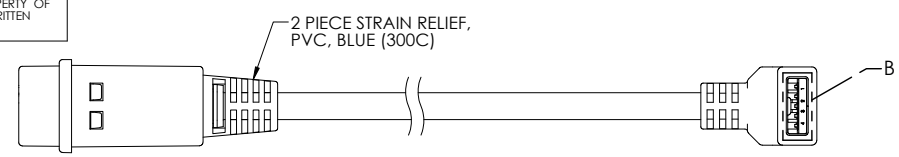
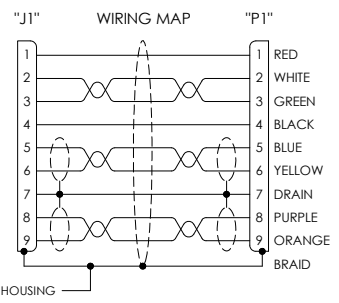
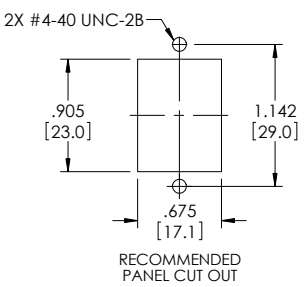
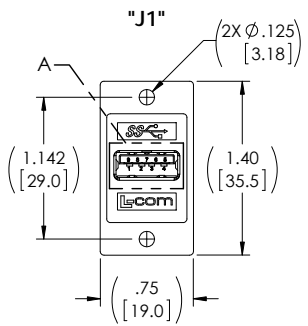
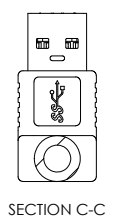
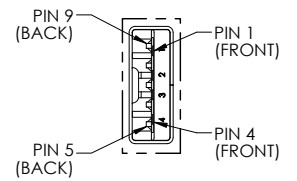
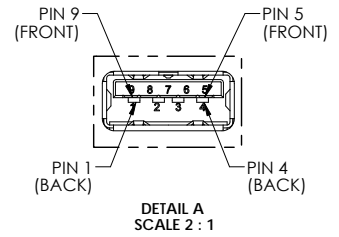
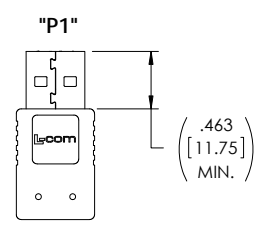
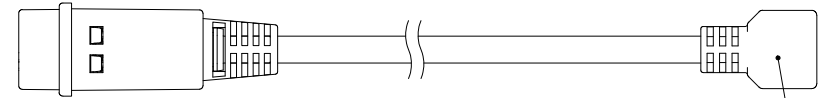

PART NUMBER	LENGTH	
	INCHES	MM
U3A00035-12I	12.0	[304.8]
U3A00035-24I	24.0	[609.6]
U3A00035-36I	36.0	[914.4]
U3A00035-50I	50.0	[1270.0]

**NOTES:**  
 1. OPERATING TEMPERATURE: -10°C TO +70°C  
 2. CABLE ASSEMBLY SHALL BE TESTED FOR CONTINUITY.  
 3. CABLE ASSEMBLY SHALL BE INDIVIDUALLY PACKAGED IN ACCORDANCE WITH L-COM SPECIFICATION PS-0031.

**REGULATORY COMPLIANCE:**  
 CE2011/65/EU (RoHS DIRECTIVE)

UNLESS OTHERWISE SPECIFIED, DIMENSIONS ARE IN INCHES (mm)  
 OVERALL CABLE LENGTH TOLERANCE:  
 ≤12 [305] ±.01 [25] / 0  
 >12 [305] ≤40 [1024] ±.015 [11.75] / 0  
 >40 [1024] ≤120 [3048] ±.02 [5.08] ±.01 [2.54] / 0  
 >120 [3048] ≤300 [7620] ±.03 [1.52] / 0  
 >300 [7620] ±.05 [1.27] / 0  
 ALL OTHER DIMENSIONAL TOLERANCES:  
 X = ±.01 [0.25]  
 XX = ±.02 [0.51]  
 XXX = ±.05 [1.27]

APPROVALS DATE  
 DRAWN BY SJJ 06/07/17  
 CHECKED BY B.ZHANG 06/07/17  
 APPROVED BY S.PAN 06/07/17

**L-com** Global Connectivity 50 HIGH STREET NORTH ANDOVER, MA 01845

CATEGORY: USB

PRODUCT DESCRIPTION: USB3.0 A-F PNL MNT/90UP A-M SHLD

SIZE: <b>B</b>	FSCM NO.: 43321	DWG. NO.: U3A00035	REV.: A
----------------	-----------------	--------------------	---------

SCALE: NONE CAD FILE: U3A00035.SLDRAW SHEET 1 OF 1

