

Automotive Relays

CT RELAYS POWER TYPE

Product Catalog

**IN Your
Future**

CT RELAYS POWER TYPE

High Carrying Current Type, Small & Slim Automotive Relay

[Protective construction] Sealed

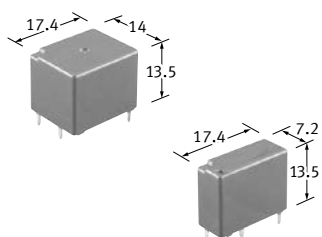

(Unit: mm)

FEATURES

- Maximum carrying current of 35 A made possible through using the same size as the CT relays
- Low operation noise

TYPICAL APPLICATIONS

- Powered windows, Automatic door locks, Powered sunroof, Powered seats and Slide door closers, etc.

ORDERING INFORMATION (PART NO.)

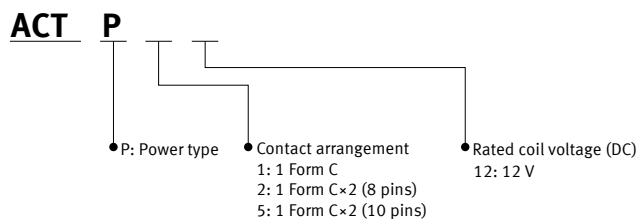

TYPES

Contact arrangement	Rated coil voltage	Part No.	Packing	
			Carton (1-tube)	Case
1 Form C	12 V DC	ACTP112	30 pcs.	1,500 pcs.
1 Form C x 2 (8 pins)		ACTP212	30 pcs.	900 pcs.
1 Form C x 2 (10 pins)		ACTP512		

RATING

Coil data

Rated coil voltage	Operate voltage (at 20°C) (initial)	Release voltage (at 20°C) (initial)	Rated operating current [±10%] (at 20°C)	Coil resistance [±10%] (at 20°C)	Rated operating power (at 20°C)	Usable voltage range
12 V DC	Max. 7.2 V DC	Min. 1.0 V DC	83.3 mA	144 Ω	1,000 mW	10 to 16 V DC

Note: Other operate voltage types are also available. Please inquire our sales representative for details.

Automotive Relays CT RELAYS POWER TYPE

Specifications

Item	Specifications	
Contact data	Contact arrangement	1 Form C x 2, 1 Form C
	Contact resistance (initial)	Max. 100 mΩ (N.O. side: typ. 7 mΩ, N.C. side: typ. 10 mΩ) (By voltage drop 1 A 6 V DC)
	Contact material	Ag alloy
	Rated switching capacity (resistive)	N.O. side: 30 A 14 V DC, N.C. side: 10 A 14 V DC
	Max. carrying current*1	N.O. side: 25 A/1 hour, 40 A/2 min (Coil applied voltage 14 V DC, at 20°C)
	Min. switching load (resistive)*2	1 A 14 V DC (at 20°C)
Insulated resistance (initial)		Min. 100 MΩ (at 500 V DC, Measurement at same location as "Dielectric strength" section.)
Dielectric strength (initial)	Between open contacts	500 Vrms for 1 min (Detection current: 10 mA)
	Between contacts and coil	500 Vrms for 1 min (Detection current: 10 mA)
Time characteristics (initial)	Operate time (at rated voltage)	Max. 10 ms (at 20°C, without contact bounce time)
	Release time (at rated voltage)	Max. 10 ms (at 20°C, without contact bounce time) (without diode)
Shock resistance	Functional	Min. 100 m/s ² (Half-wave pulse of sine wave: 11 ms, detection time: 10 μs)
	Destructive	Min. 1,000 m/s ² (Half-wave pulse of sine wave: 6 ms)
Vibration resistance	Functional	10 to 100 Hz, Min. 44.1 m/s ² (Detection time: 10 μs)
	Destructive	10 to 500 Hz, Min. 44.1 m/s ² (Time of vibration for each direction; X, Y direction: 2 hours, Z direction: 4 hours)
Expected life	Mechanical	Min. 10 x 10 ⁶ (at 120 times/min)
	Electrical	<Resistive load> Min. 5 x 10 ⁴ (at rated switching capacity, operating frequency: 1 s ON, 9 s OFF) <Motor load> N.O. side: Min. 10 ⁵ at inrush 30 A, steady 7 A 14 V DC Min. 5 x 10 ⁴ at 30 A 14 V DC motor lock condition N.C. side: Min. 10 ⁵ at break current 15 A 14 V DC (operating frequency: 0.5 s ON, 9.5 s OFF)
Conditions	Conditions for usage, transport and storage*3	Ambient temperature: -40 to +85°C, Humidity: 5 to 85% RH (Avoid icing and condensation)
Weight		Approx. 8 g (twin type), Approx. 4 g (1 Form C type)

Notes: *1. Depends on connection conditions. Also, this does not guarantee repeated switching. We recommend that you confirm operation under actual conditions.

*2. This value can change due to the switching frequency, environmental conditions, and desired reliability level, therefore it is recommended to check this with the actual load.

*3. The upper operation ambient temperature limit is the maximum temperature that can satisfy the coil temperature rise value. For details, please refer to the "Automotive Relay Users Guide".

Please inquire our sales representative if you will be using the relay in a high temperature atmosphere (110°C).

★ If the relay is used continuously for long periods of time with coils on both sides in an energized condition, breakdown might occur due to abnormal heating depending on the carrying condition. Therefore, please inquire our sales representative when using with a circuit that causes an energized condition on both sides simultaneously.

REFERENCE DATA

1-1. Coil temperature rise (at room temperature)

Sample: ACTP212, 3 pcs.
Carrying current: 0 A, 10 A, 20 A
Ambient temperature: Room temperature

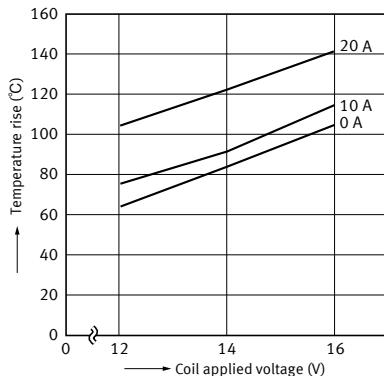

1-2. Coil temperature rise (at 85°C)

Sample: ACTP212, 3 pcs.
Carrying current: 0 A, 10 A, 20 A
Ambient temperature: 85°C

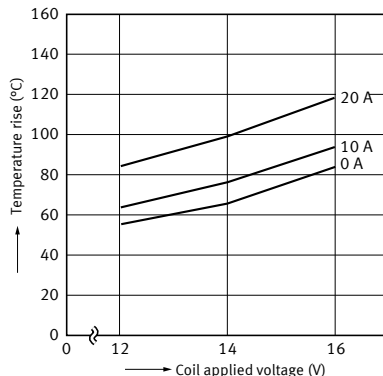

2. Ambient temperature and usable voltage range

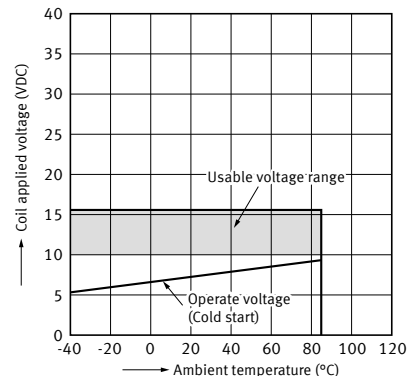

3. Distribution of operate and release voltage 4. Distribution of operate and release time

Sample: ACTP212, 80 pcs.

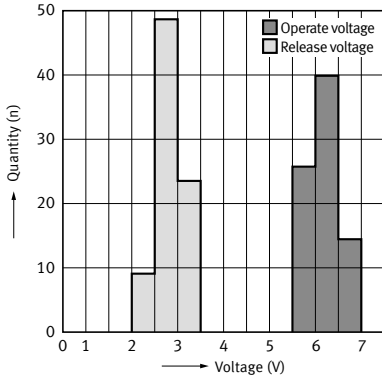

Sample: ACTP212, 80 pcs.

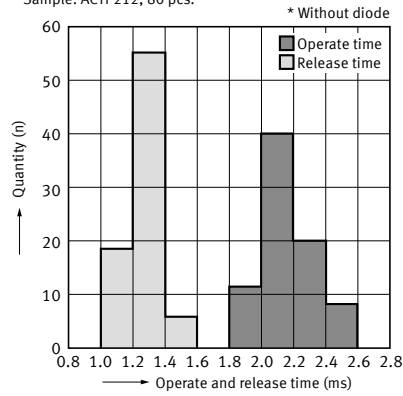

5-1. Electrical life test (Motor free)

Sample: ACTP212, 3 pcs.
 Load: Inrush current: 30 A, Steady current: 7 A
 Brake current: 15 A 14 V DC,
 Power window motor actual load
 Operating frequency: ON 0.5 s, OFF 9.5 s
 Ambient temperature: Room temperature
 Circuit:

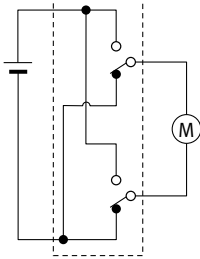

Change of operate and release voltage

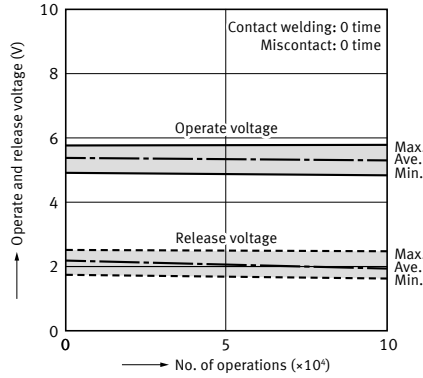

Change of contact resistance

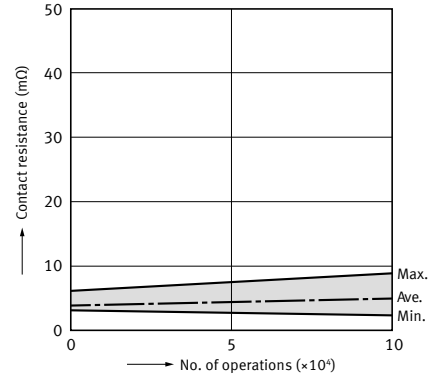

Load current waveform

Load: Inrush current: 30 A, Steady current: 7 A
 Brake current: 15 A

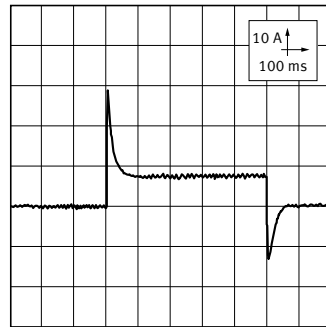

Automotive Relays CT RELAYS POWER TYPE

5-2. Electrical life test (Motor lock)

Sample: ACTP212, 3 pcs.
 Load: 30 A 14 V DC
 Operating frequency: ON 0.5 s, OFF 9.5 s
 Ambient temperature: Room temperature
 Circuit:

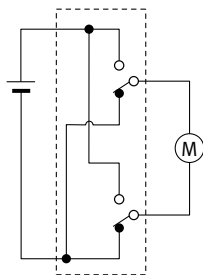

Change of operate and release voltage

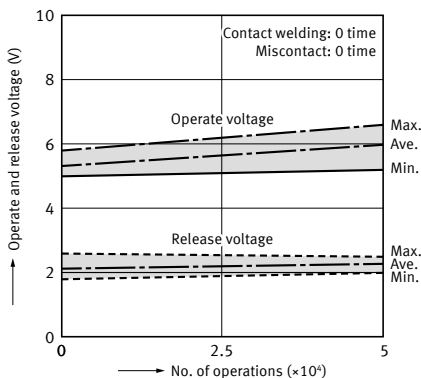

Change of contact resistance

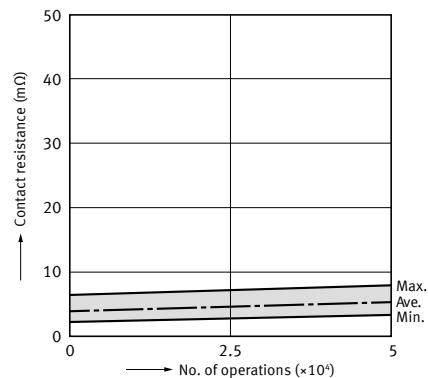

Load current waveform

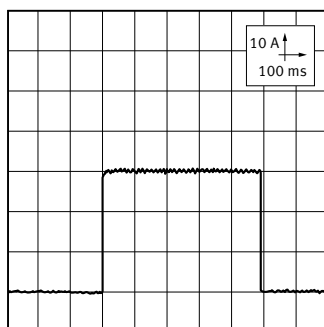

DIMENSIONS

CAD The CAD data of the products with a "CAD" mark can be downloaded from our Website.

Unit: mm

■ Twin type (8 pins)

CAD



External dimensions

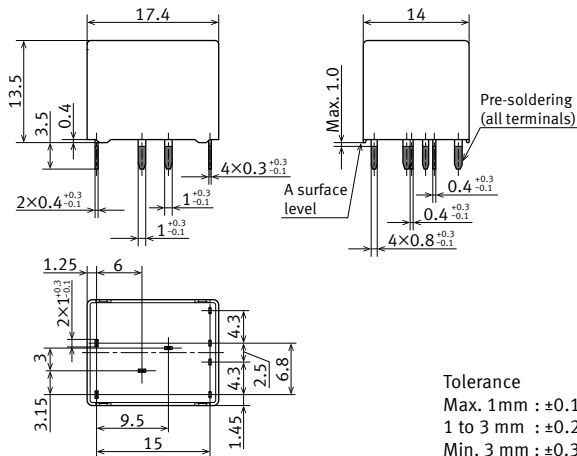

* Dimensions (thickness and width) of terminal is measured after pre-soldering.
 Intervals between terminals is measured at A surface level.

PC board pattern (BOTTOM VIEW)

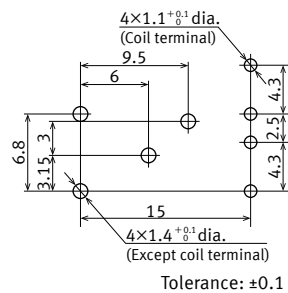

Schematic (BOTTOM VIEW)

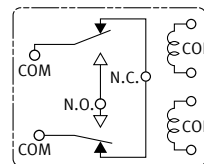

■ Twin type (10 pins)

CAD



External dimensions

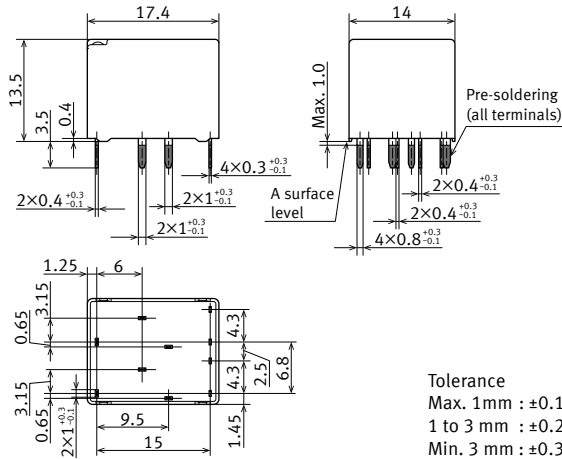

* Dimensions (thickness and width) of terminal is measured after pre-soldering. Intervals between terminals is measured at A surface level.

PC board pattern (BOTTOM VIEW)

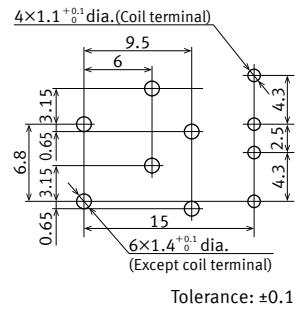

Schematic (BOTTOM VIEW)

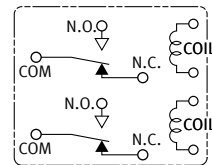

■ Slim type (1 Form C)

CAD



External dimensions

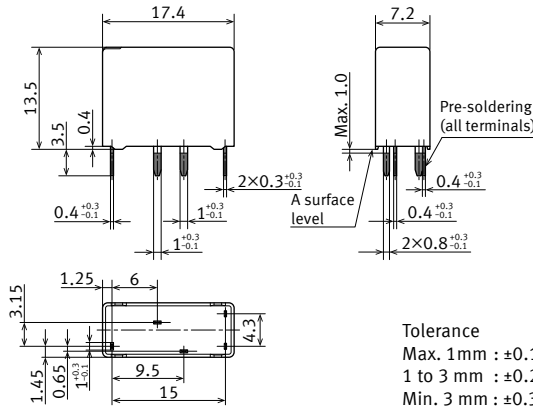

* Dimensions (thickness and width) of is measured after pre-soldering. Intervals between terminals is measured at A surface level.

PC board pattern (BOTTOM VIEW)

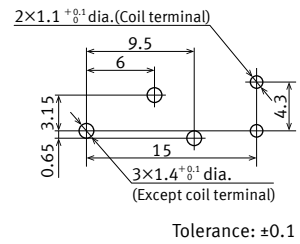

Schematic (BOTTOM VIEW)

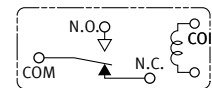

GUIDELINES FOR USAGE

■ For general cautions for use, please refer to the "Automotive Relay Users Guide".

Please refer to "the latest product specifications" when designing your product.

•Requests to customers:

<https://industrial.panasonic.com/ac/e/salespolicies/>



Panasonic Industry Co., Ltd.

Electromechanical Control Business Division
■1006, Oaza Kadoma, Kadoma-shi, Osaka 571-8506, Japan
industrial.panasonic.com/ac/e/