



TAOGLAS®



Datasheet

Part No:
TG.31.8113

Description:
Hinged TG.31 Wideband 5G/4G Antenna

Features:
Highest efficiency for worldwide 5G/4G and Wi-Fi
4G LTE / CAT-M1 / NB-IoT / GPS / Wi-Fi
Compatible also with 2G/3G Applications
5G NR Sub 6GHz
600MHz - 6000MHz Band 71 Applicable
Dipole Swivel Terminal Antenna
Hinged 90° termination with SMA(M) Connector
Enhanced hinge structure for Vibration Environments
RoHS & REACH Compliant

1. Introduction	3
2. Specifications	4
3. Antenna Characteristics	6
4. 2D Radiation Patterns	9
5. Mechanical Drawing	12
6. Packaging	13
<hr/>	
Changelog	14

Taoglas makes no warranties based on the accuracy or completeness of the contents of this document and reserves the right to make changes to specifications and product descriptions at any time without notice. Taoglas reserves all rights to this document and the information contained herein. Reproduction, use or disclosure to third parties without express permission is strictly prohibited.



1. Introduction

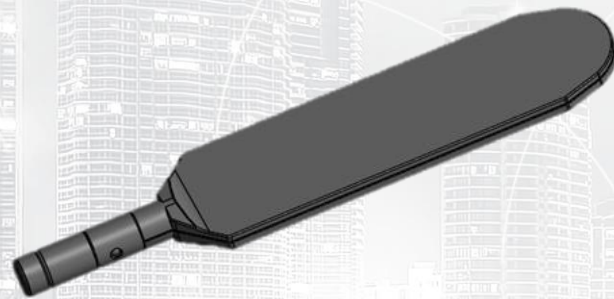

The Taoglas TG.31.8113 has been expertly designed to meet the requirements of the next generation of 5G modules, gateways and routers. The TG.31 was created from the existing TG.30, meaning the already excellent TG.30 has been leveraged to create the TG.31. The antenna is a ground plane independent (Dipole) antenna with a SMA (M) connector and swivel mechanism that allows the antenna part to be rotated. The TG.31 exhibits high efficiency across the 600-6000MHz cellular spectrum.

Typical Applications Include:

- POS Kiosks
- Robotics and Autonomous
- Gateways and Routers

With very high efficiency on every cellular band globally it is an ideal solution for any device requiring high, reliable performance. It is also guaranteed to meet any type of approval or carrier certification requirements from a RF standpoint. It is an omni-directional antenna, and the radiation patterns display this and are stable across all bands.

It has a quality robust UV resistant housing for use with wireless terminals. The swivel and hinge mechanism allows the antenna part itself to be orientated in different directions and can help avoid touching off other antennas or objects close by as well as helping with isolation by orientating the antenna in different directions in MIMO systems.

2. Specifications

Electrical								
Band	Frequency (MHz)	Efficiency (%)	Average Gain (dB)	Peak Gain (dBi)	Impedance	Max Input Power	Polarization	Radiation Pattern
5G NR/4G Band 71	617~698	23	-7.0	-1.9	50 Ω	10W	Linear	Omni-Directional
4G/3G Band 12,13,14,17,28,29	698~824	64	-2.0	1.2				
4G/3G/NB-IoT/Cat M Band 5,8,18,19,20,26,27	824~960	56	-2.6	0.8				
5G NR/4G Band 21,32,74,75,76	1427~1518	20	-7.1	-1.2				
4G/3G Band 1,2,3,4,9,23,25,35,39,66	1710~2200	64	-2.0	4.6				
4G/3G Band 7,30,38,40,41	2300~2690	47	-3.4	4.2				
5G NR/4G Band 22,42,48,77,78,79	3300~5000	43	-3.8	3.2				
LTE5200/ Wi-Fi 5800	5150~5925	46	-3.7	4.4				
Mechanical								
Casing			UV Resistant PC/ABS					
Connector			SMA Male Hinged 90°					
Environmental								
Temperature Range			-40°C to 85°C					
Humidity			Non-condensing 65°C 95% RH					

5G/4G Bands			
Band Number	5G / FR1 / LTE / LTE-Advanced / WCDMA / HSPA / HSPA+ / TD-SCDMA		
	Uplink	Downlink	Covered
1	UL: 1920 to 1980	DL: 2110 to 2170	✓
2	UL: 1850 to 1910	DL: 1930 to 1990	✓
3	UL: 1710 to 1785	DL: 1805 to 1880	✓
4	UL: 1710 to 1755	DL: 2110 to 2155	✓
5	UL: 824 to 849	DL: 869 to 894	✓
7	UL: 2500 to 2570	DL: 2620 to 2690	✓
8	UL: 880 to 915	DL: 925 to 960	✓
9	UL: 1749.9 to 1784.9	DL: 1844.9 to 1879.9	✓
11	UL: 1427.9 to 1447.9	DL: 1475.9 to 1495.9	✓
12	UL: 699 to 716	DL: 729 to 746	✓
13	UL: 777 to 787	DL: 746 to 756	✓
14	UL: 788 to 798	DL: 758 to 768	✓
17	UL: 704 to 716	DL: 734 to 746	✓
18	UL: 815 to 830	DL: 860 to 875	✓
19	UL: 830 to 845	DL: 875 to 890	✓
20	UL: 832 to 862	DL: 791 to 821	✓
21	UL: 1447.9 to 1462.9	DL: 1495.9 to 1510.9	✓
22	UL: 3410 to 3490	DL: 3510 to 3590	✓
23	UL: 2000 to 2020	DL: 2180 to 2200	✓
24	UL: 1625.5 to 1660.5	DL: 1525 to 1559	✓
25	UL: 1850 to 1915	DL: 1930 to 1995	✓
26	UL: 814 to 849	DL: 859 to 894	✓
27	UL: 807 to 824	DL: 852 to 869	✓
28	UL: 703 to 748	DL: 758 to 803	✓
29	UL: -	DL: 717 to 728	✓
30	UL: 2305 to 2315	DL: 2350 to 2360	✓
31	UL: 452.5 to 457.5	DL: 462.5 to 467.5	✗
32	UL: -	DL: 1452 - 1496	✓
35		1850 to 1910	✓
38		2570 to 2620	✓
39		1880 to 1920	✓
40		2300 to 2400	✓
41		2496 to 2690	✓
42		3400 to 3600	✓
43		3600 to 3800	✓
48		3550 to 3700	✓
66	UL: 1710-1780	DL: 2110-2200	✓
71		617 to 698	✓
74/75/76		1427 to 1518	✓
78		3300 to 3800	✓
79		4400 to 5000	✓

3. Antenna Characteristics

3.1 Return Loss

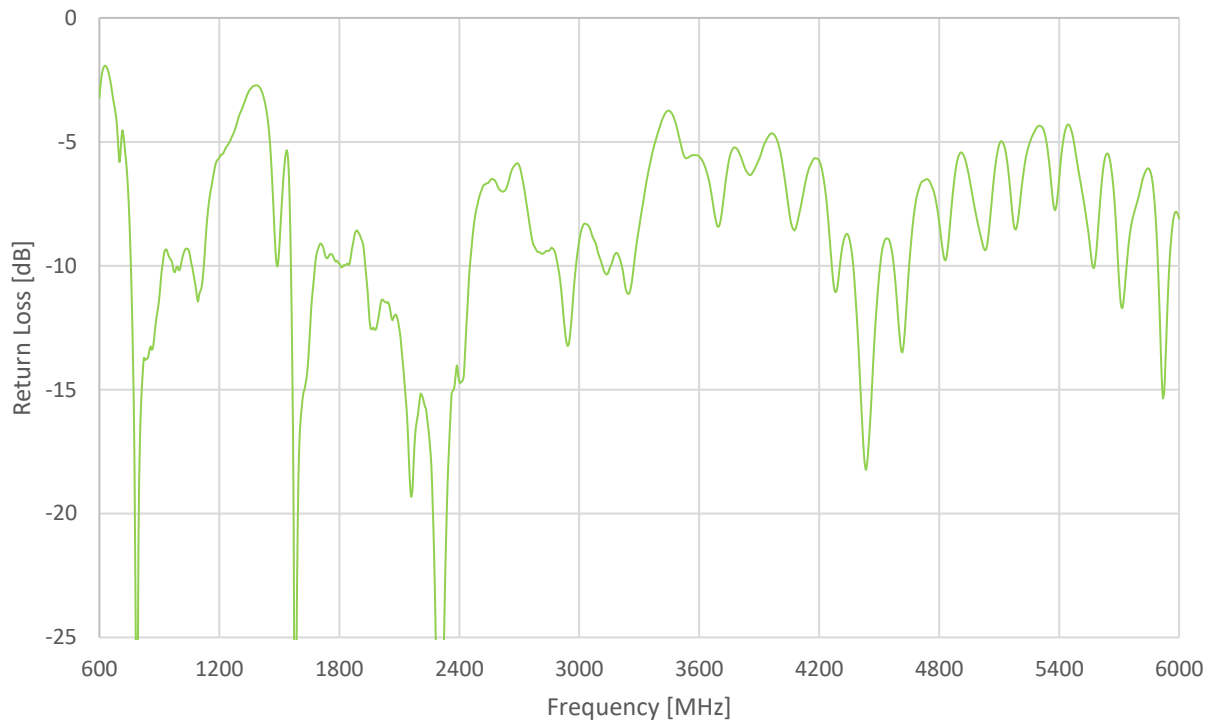

3.2 VSWR

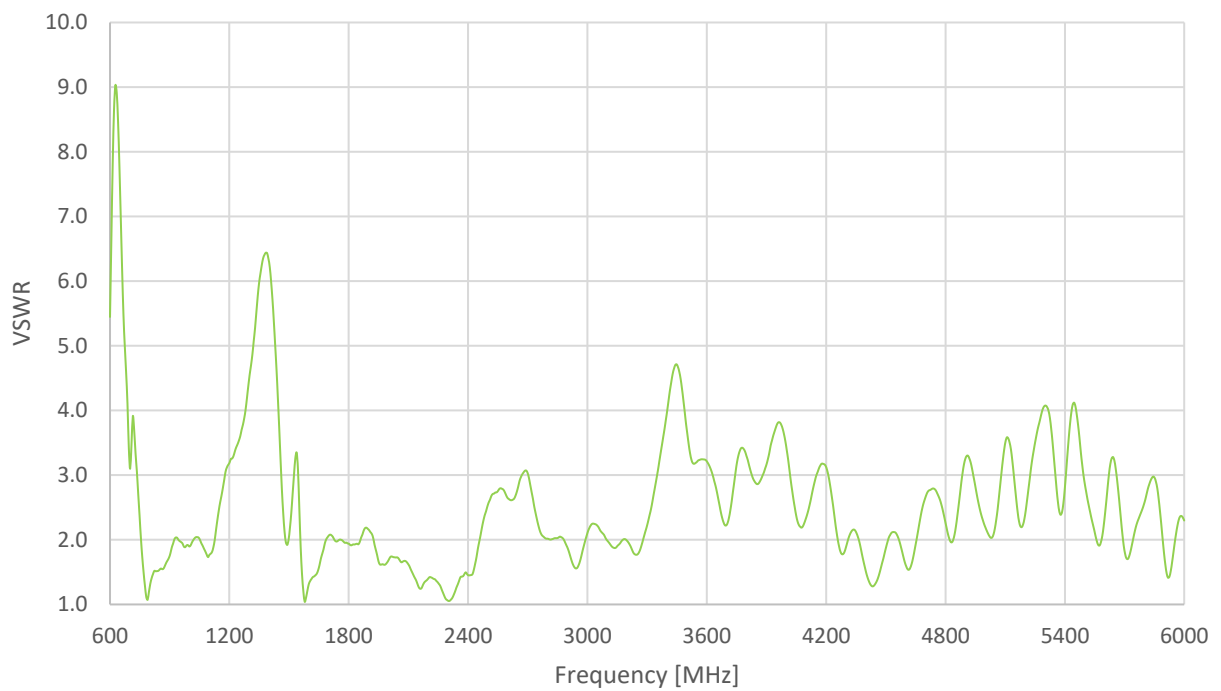

3.3 Efficiency

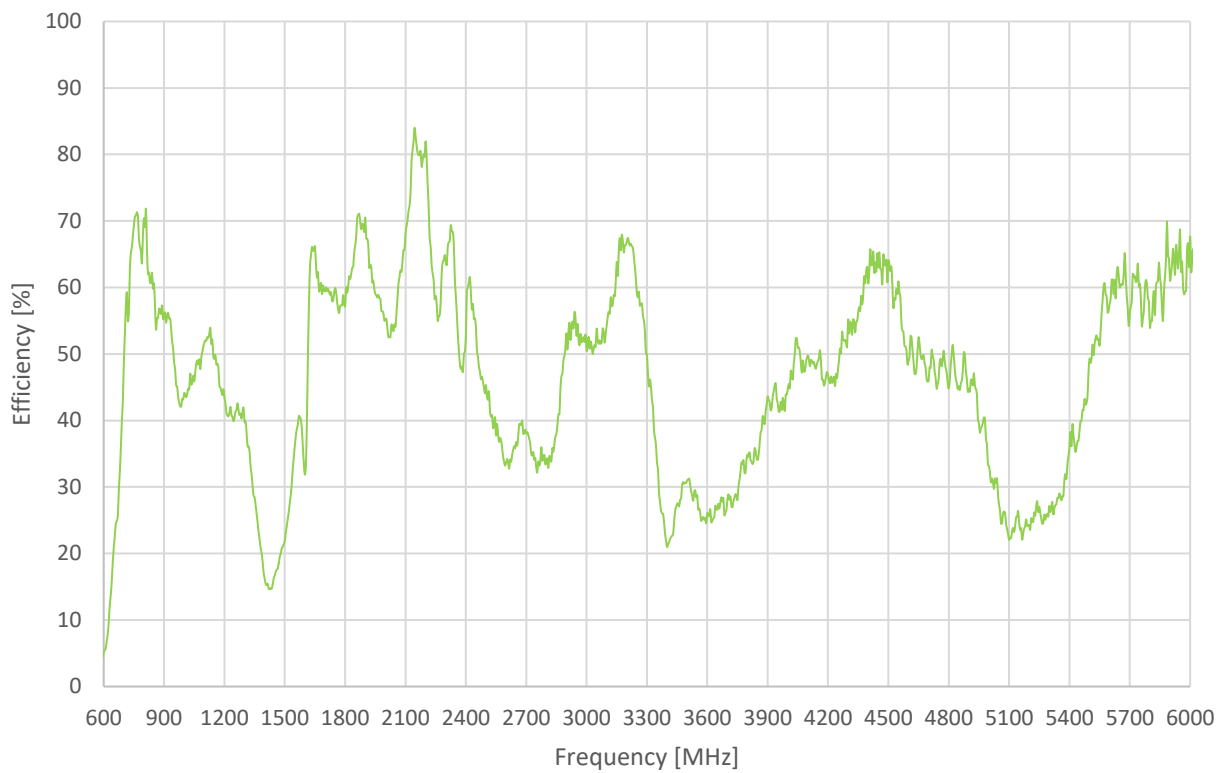

3.3 Peak Gain

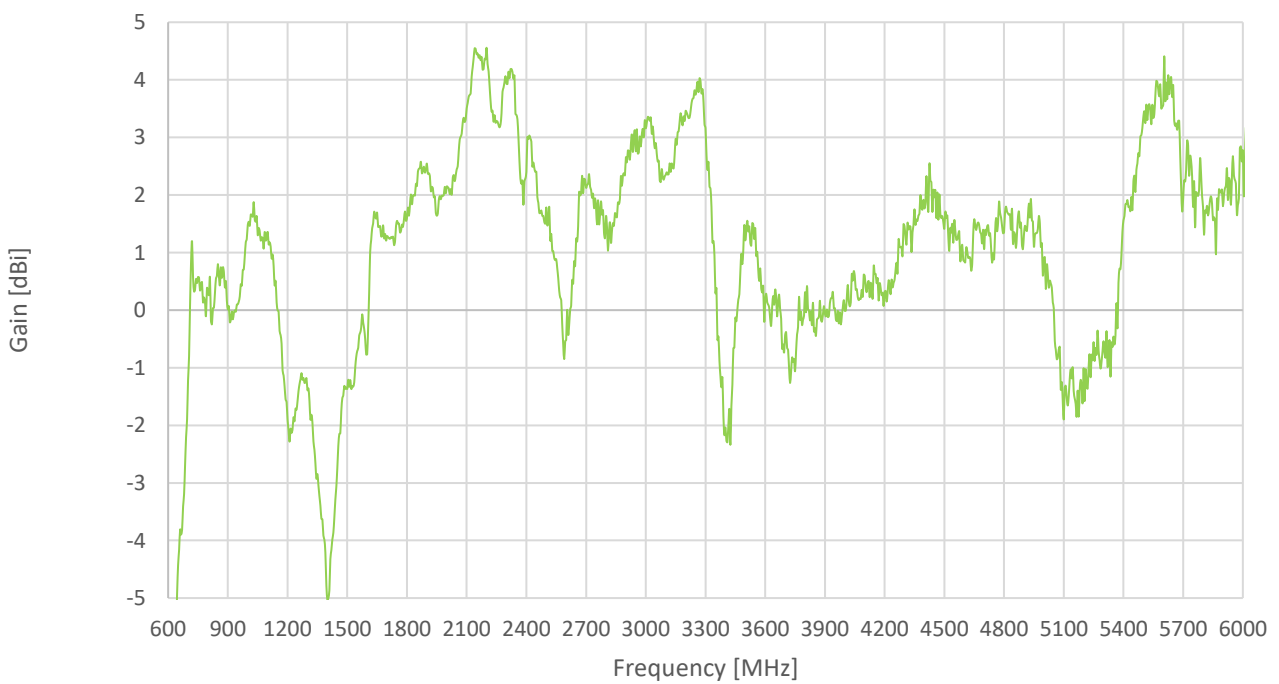

3.3 Average Gain

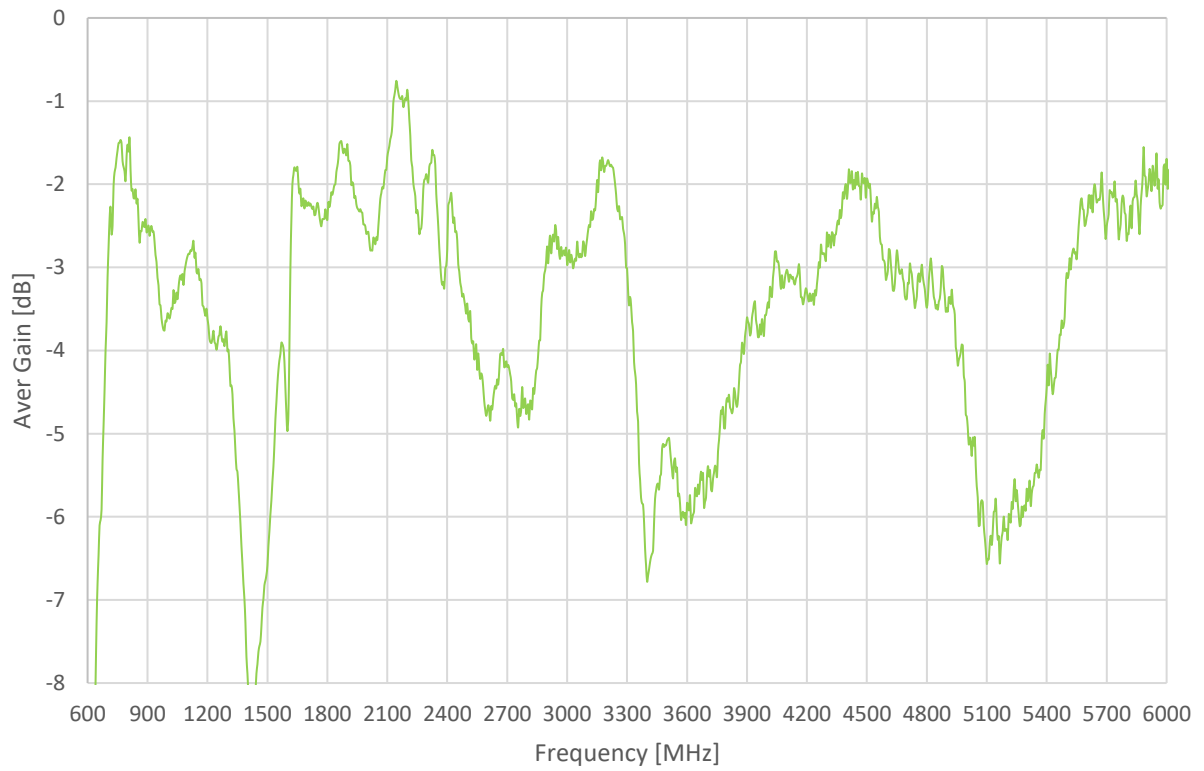

4. 2D Radiation Patterns

XY Plane

XZ Plane

YZ Plane

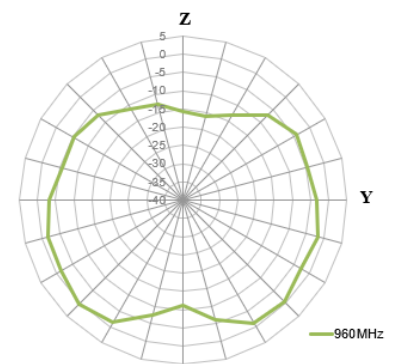
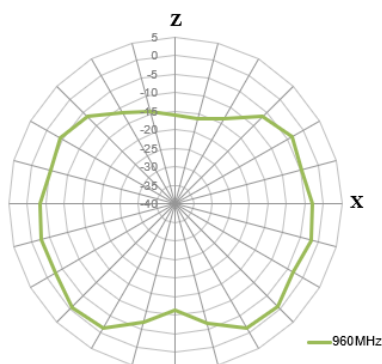
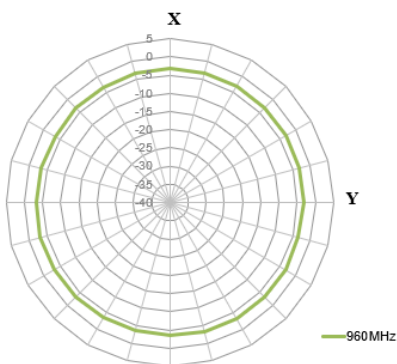
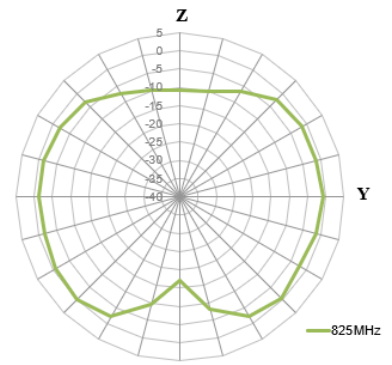
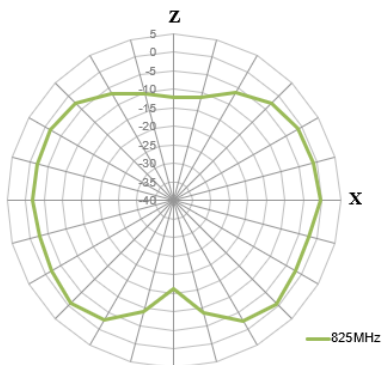
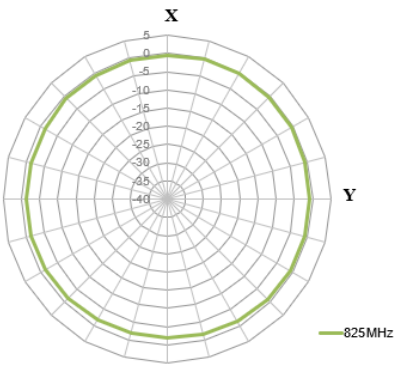
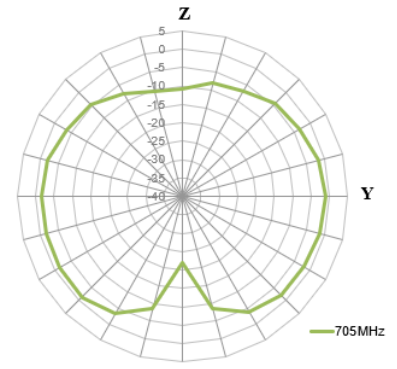
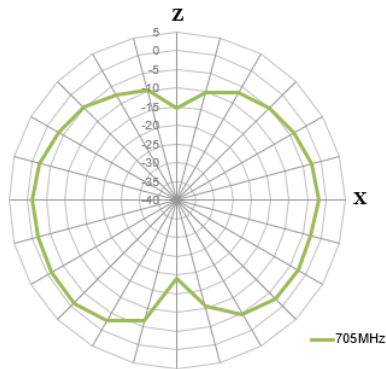
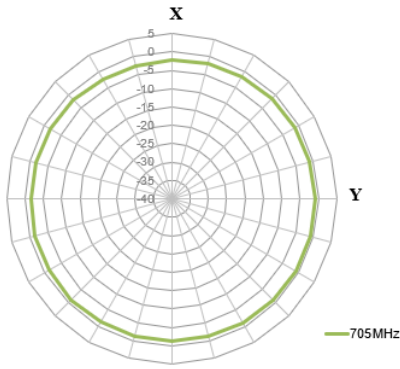

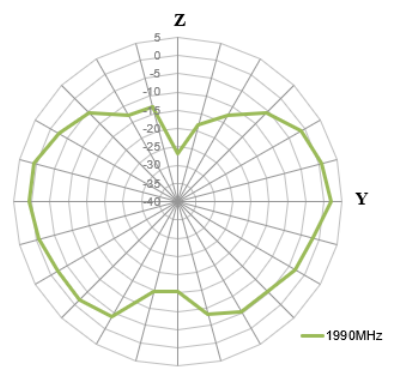
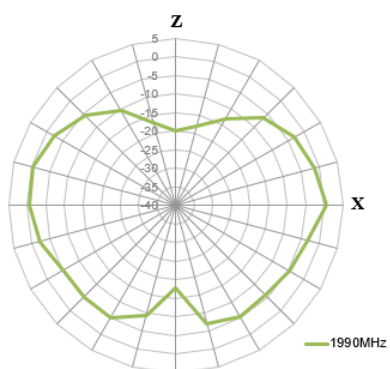
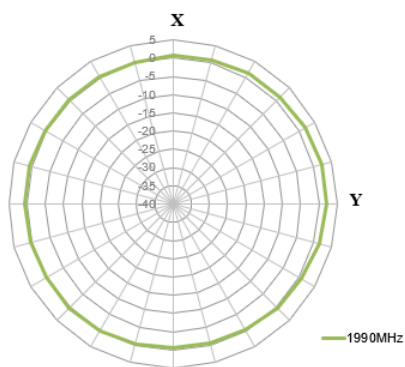
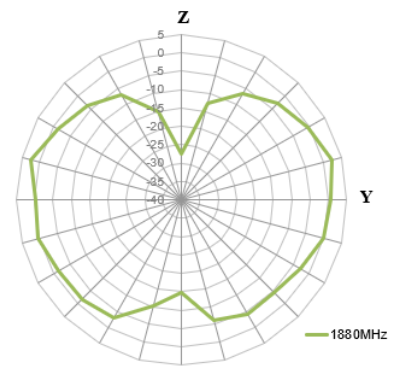
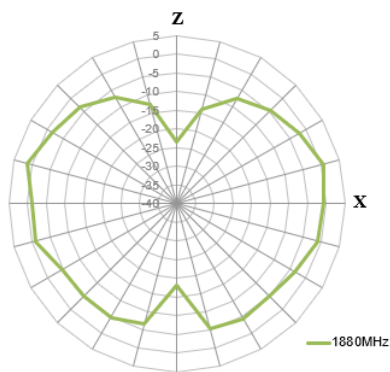
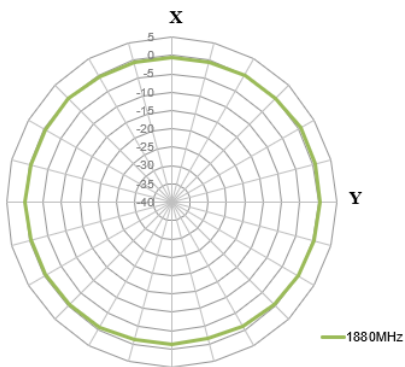
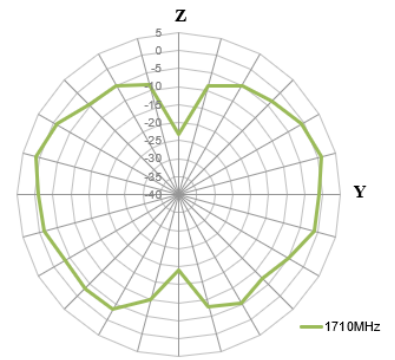
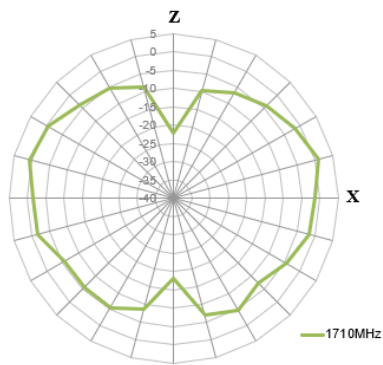
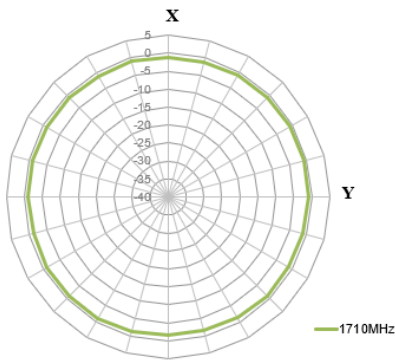

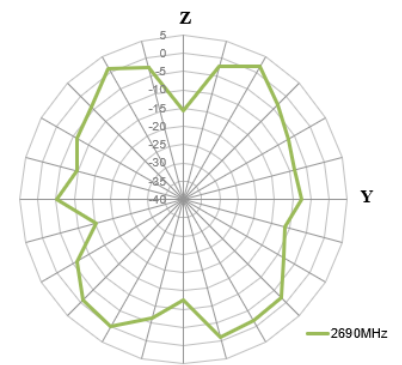
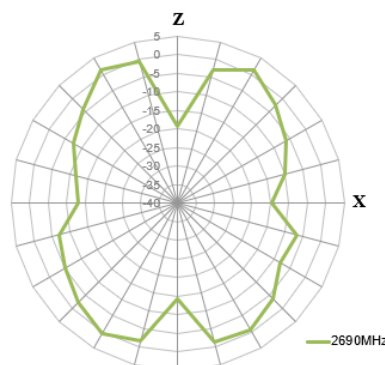
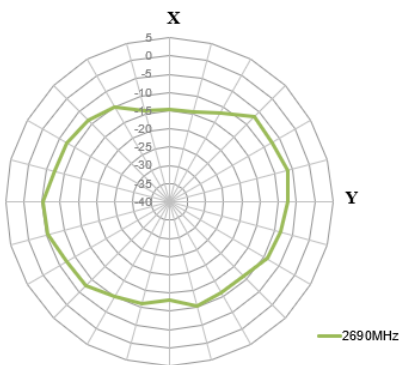
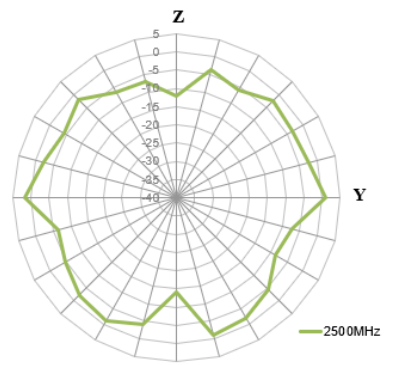
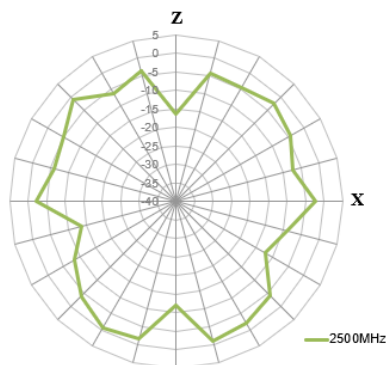
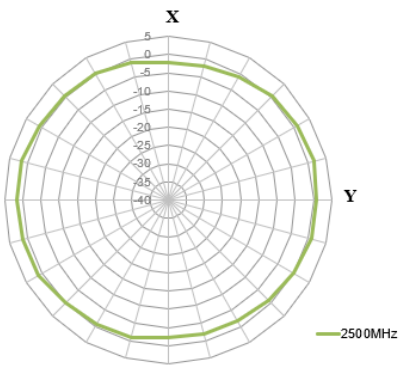
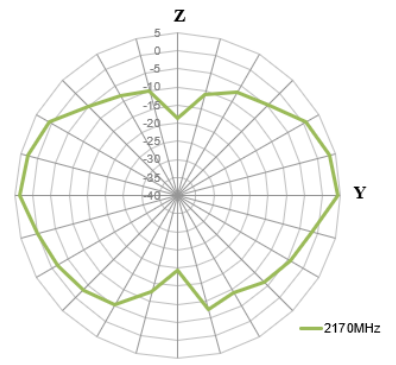
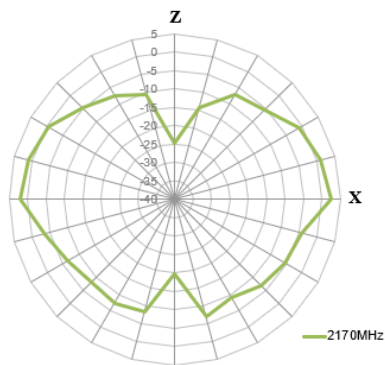
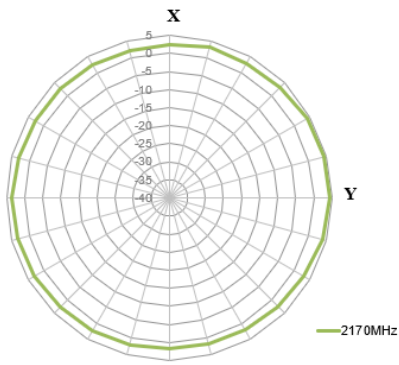

5. Mechanical Drawing (Units: mm)

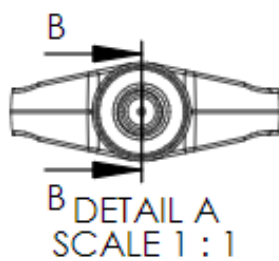
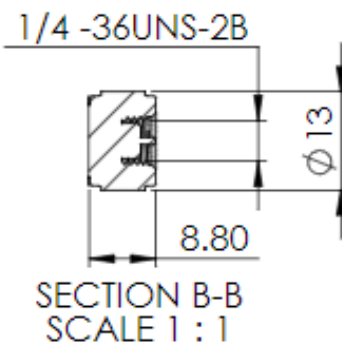
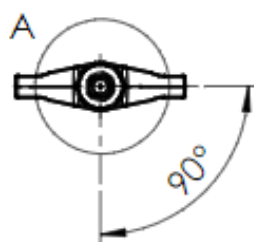
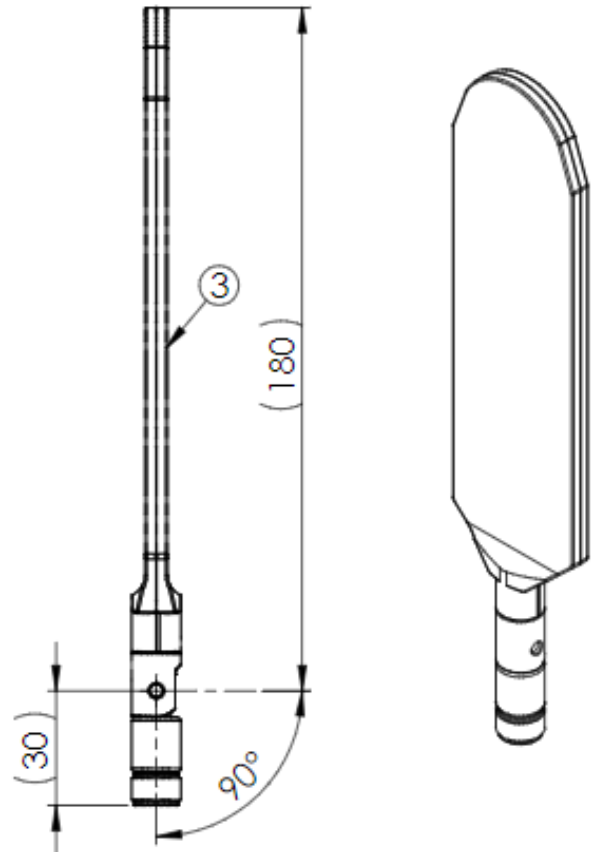
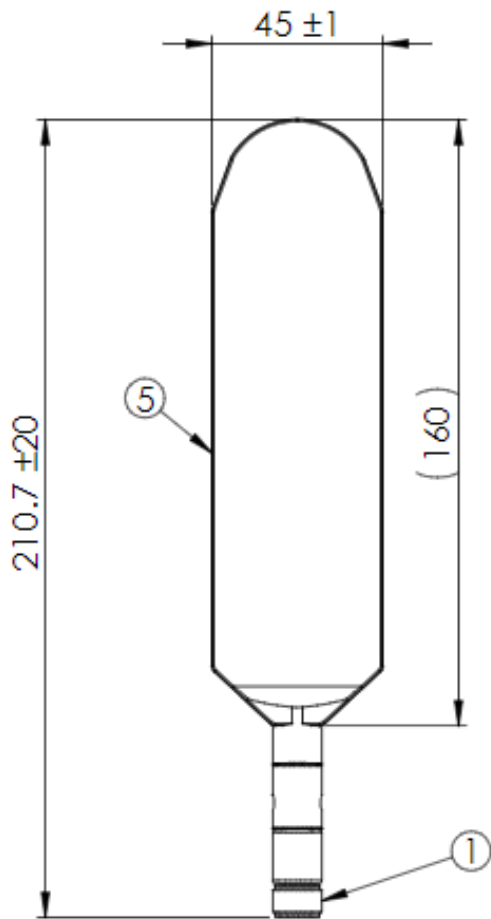

6. Packaging

1pc TG.31.8113 per Small PE Bag



50pcs per Large PE Bag

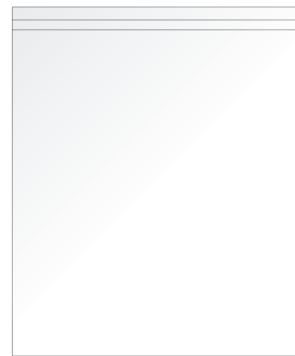

250pcs TG.31.8113 per Carton
Carton Dimensions: 430*380*280mm

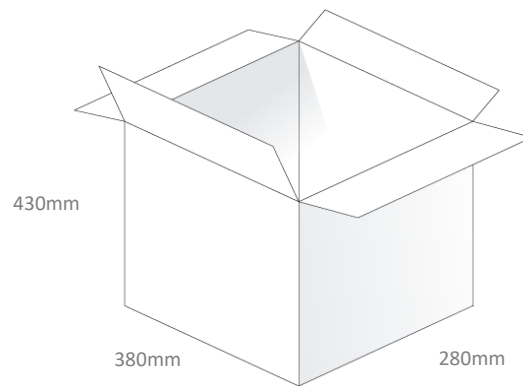

Changelog for the datasheet

SPE-21-8-124 – TG.31.8113

Revision: B (Current Version)

Date:	2022-07-25
Notes:	Updated Packaging info
Author:	Jack Conroy

Previous Revisions

Revision: A (Original First Release)

Date:	2021-12-17
Notes:	
Author:	Gary West



TAOGLAS®

www.taoglas.com

