



TAOGLAS®



Datasheet

Accura UWB UWC.01

Part No:
UWC.01

Description:

6~8GHz Ultra-Wide Band (UWB) SMD Chip Antenna

Features:

SMD Chip UWB Antenna

For European and USA UWB Applications

In Channels 5-7

Uses

- Automotive sensors
- Smart airbags
- Precision surveying
- Smart home and entertainment systems
- Centimeter Level Positioning

Frequency: 6.0-8GHz

Dimensions: 5.5*5.5*2mm

RoHS and REACH Compliant

1. Introduction	3
2. Specifications	5
3. Antenna Characteristics	6
4. Radiation Patterns	10
5. Mechanical Drawing	12
6. Antenna Integration Guide	13
7. Packaging	21
8. Solder Reflow Profile	23
<hr/>	
Changelog	24

Taoglas makes no warranties based on the accuracy or completeness of the contents of this document and reserves the right to make changes to specifications and product descriptions at any time without notice. Taoglas reserves all rights to this document and the information contained herein. Reproduction, use or disclosure to third parties without express permission is strictly prohibited.



1. Introduction



The UWC.01 chip antenna, at 5.5*5.5*2 mm, is a small form factor Ultra-Wideband (UWB) antenna with high efficiencies across the pulsed UWB communications operational bands. It is mounted to a PCB via standard SMT reflow process. It enables designers to use only one antenna that covers all common UWB commercial bands, namely bands, 5, 6 and 7 simultaneously.

The UWC.01 antenna is a durable ceramic antenna that has a peak gain of 4dBi, an efficiency of more than 50% across the bands and is designed to be mounted directly onto a PCB. It is an ideal choice for any device maker that needs to keep manufacturing costs down over the lifetime of a product. Like all such antennas, care should be taken to mount the antenna at least 3mm from metal components or surfaces, and ideally 5mm for best Radiation efficiency. Minimum recommended ground plane size is 25 mm x 13 mm, and antenna to ground clearance is fixed to 0.3 mm and should not be changed (please see section 7. Application Note).

Ultra-Wideband (also known as UWB) is a low power digital wireless technology for transmitting large amounts of digital data over a wide spectrum of frequency bands typically spanning more than 500MHz with very low power for short distances.

The low power requirements of UWB mean increased battery life of sensors and tags leading to reduction in overall operational costs. Taoglas has developed various innovative and new-to-market flexible embedded UWB antennas designed for seamless integration on plastics and using highly flexible micro-coaxial cable mounting while achieving high performance where space is limited. Taoglas UWB antennas have been designed for use with the recently launched Decawave ScenSor DW1000 module and are also compatible with any other UWB sensor modules on the market.

1.1 Applications of Pulsed UWB antenna Technology

Radar - These short-pulsed antennas provide very fine range resolution and precision distance and positioning measurement capabilities. UWB signals enable inexpensive high definition radar antennas which find use in automotive sensors, smart airbags, and precision surveying applications amongst many others.

Home Network Connectivity - Smart home and entertainment systems can take advantage of high data rates for streaming high quality audio and video contents in real time for consumer electronics and computing within a home environment.

Position location & Tracking- UWB antennas also find use in Position Location and Tracking applications such as locating patients in case of critical condition, hikers injured in remote areas, tracking cars, and managing a variety of goods in a big shopping mall. UWB offers better noise immunity and better accuracy to within a few cm compared to current localization technologies such as Assisted GPS for Indoors, Wi-Fi and cellular which are at best able to offer meter level precision. Tethered Indoor Positioning UWB systems that measure the angles of arrival of ultra-wideband (UWB) radio signals perform triangulation by using multiple sensors to communicate with a tag device.

2. Specifications

Electrical			
Standard	UWB		
	USA UWB Channel 5	USA UWB Channel 6	USA UWB Channel 7
Operation Frequency (GHz)	6.24-6.74	6.76-7.24	5.95-7.03
Return Loss (dB)	-10	-8	-9
Peak Gain (dBi)	4.5	3.5	4.5
Max VSWR	2:1	2.7:1	2.2:1
Impedance	50Ω		
Polarization	Linear		
Radiation Pattern	Omnidirectional		
Max Input Power	10W		
Mechanical			
Dimensions	5.5mm x 5.5mm x 2mm		
Material	Ceramic		
Environmental			
Operation Temperature	-40°C to 105°C		
Storage Temperature	-40°C to 105°C		
Moisture Sensitivity Level (MSL)	3 (168 Hours)		
Humidity	40°C to 90°C		

* Results obtained for antenna on Standard Evaluation Board size 25mm x 20mm, with 25mm x 13mm ground plane.

3. Antenna Characteristics

3.1 Return Loss

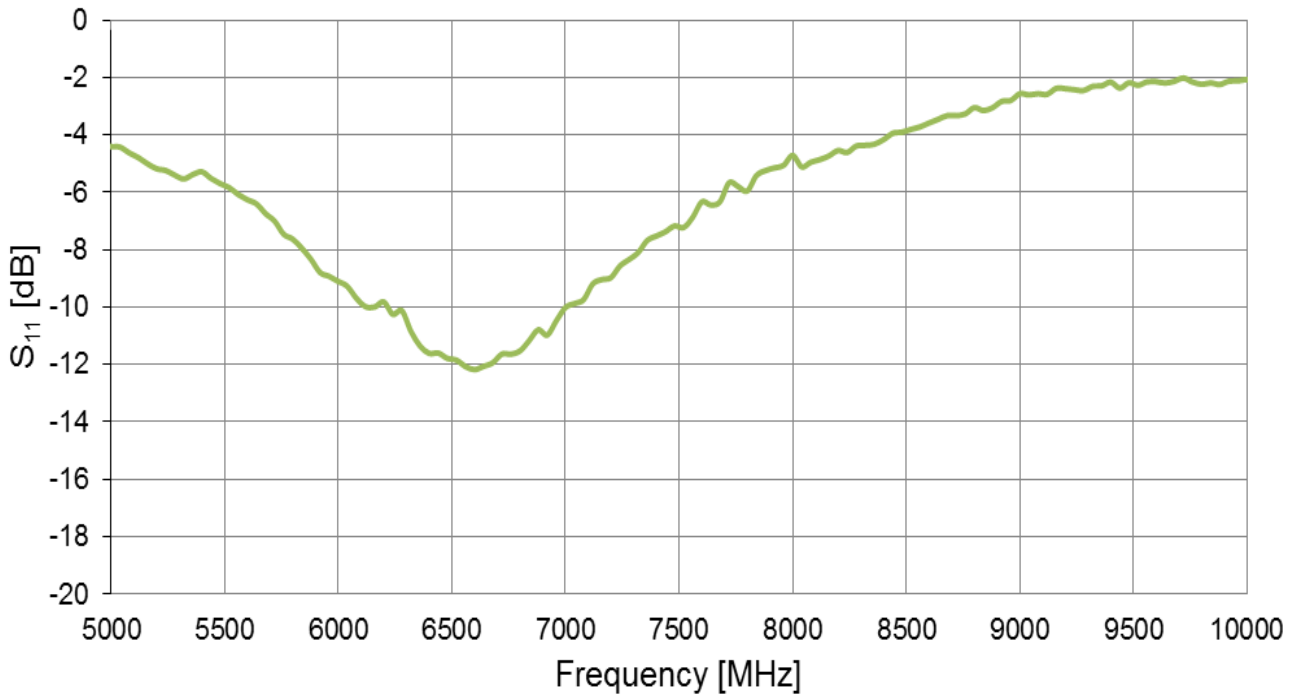

3.2 VSWR

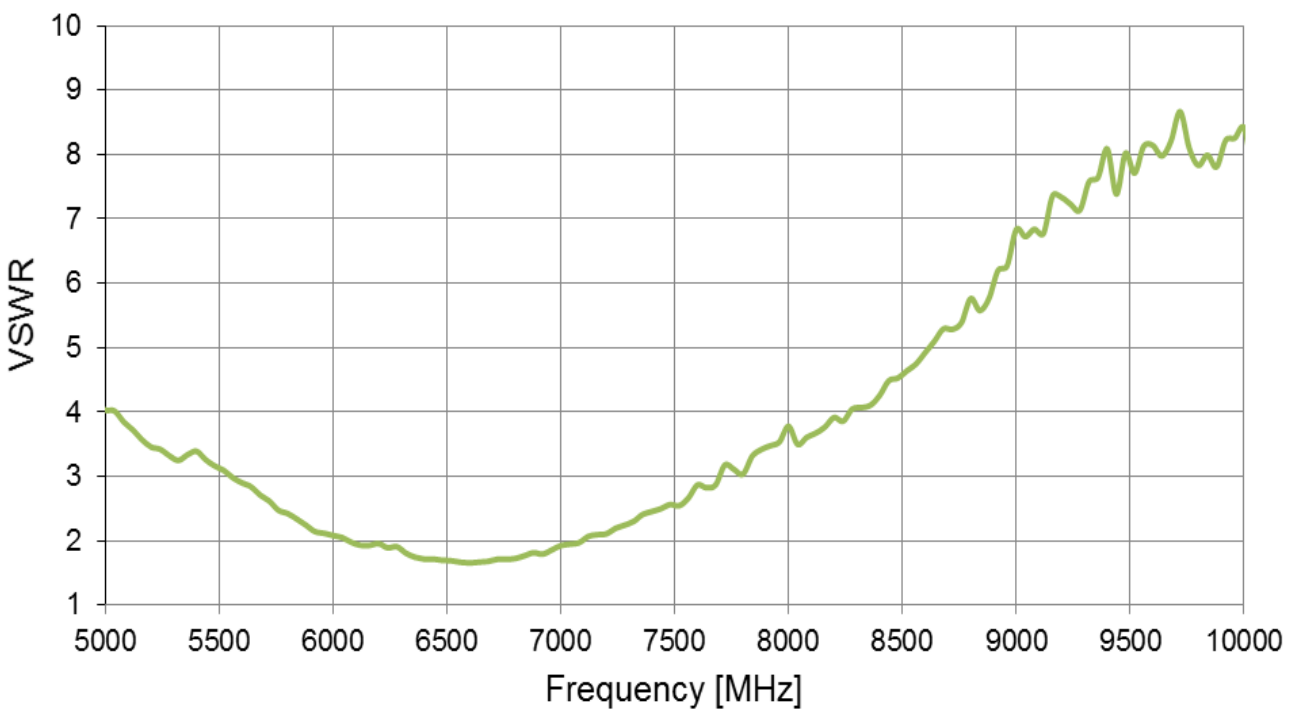

3.3 Efficiency

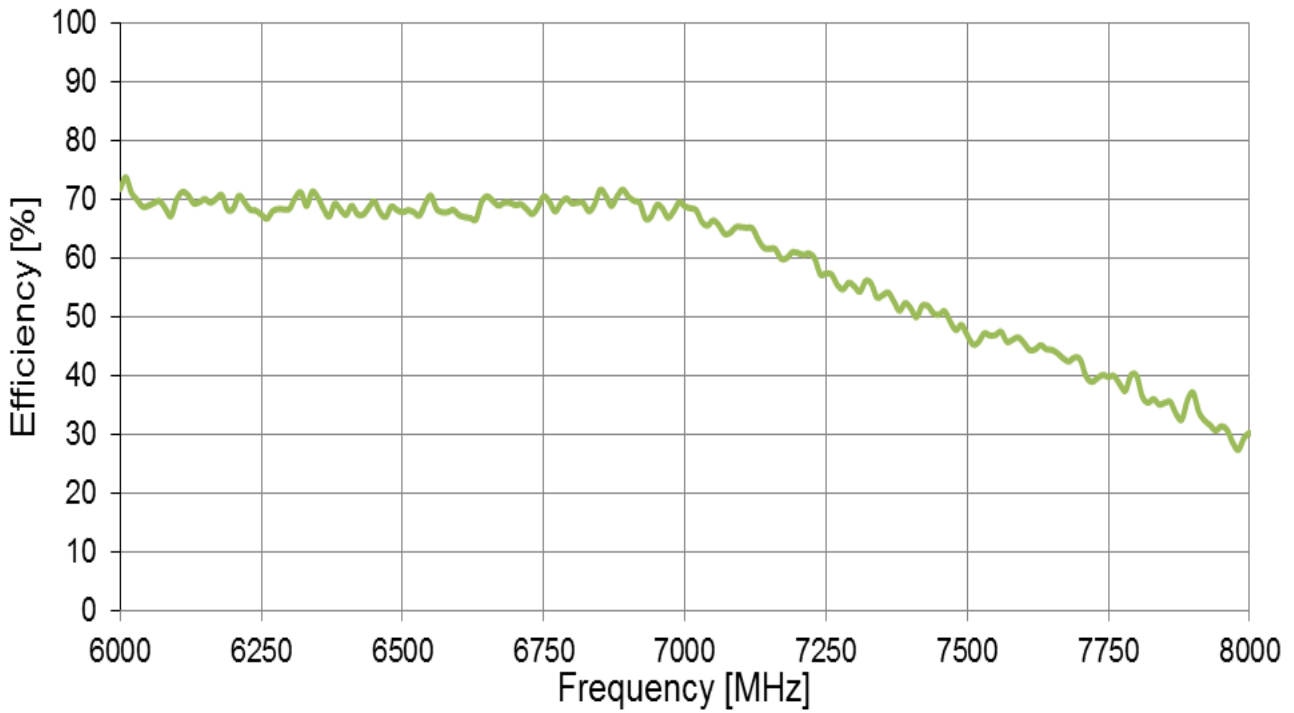

3.4 Peak Gain

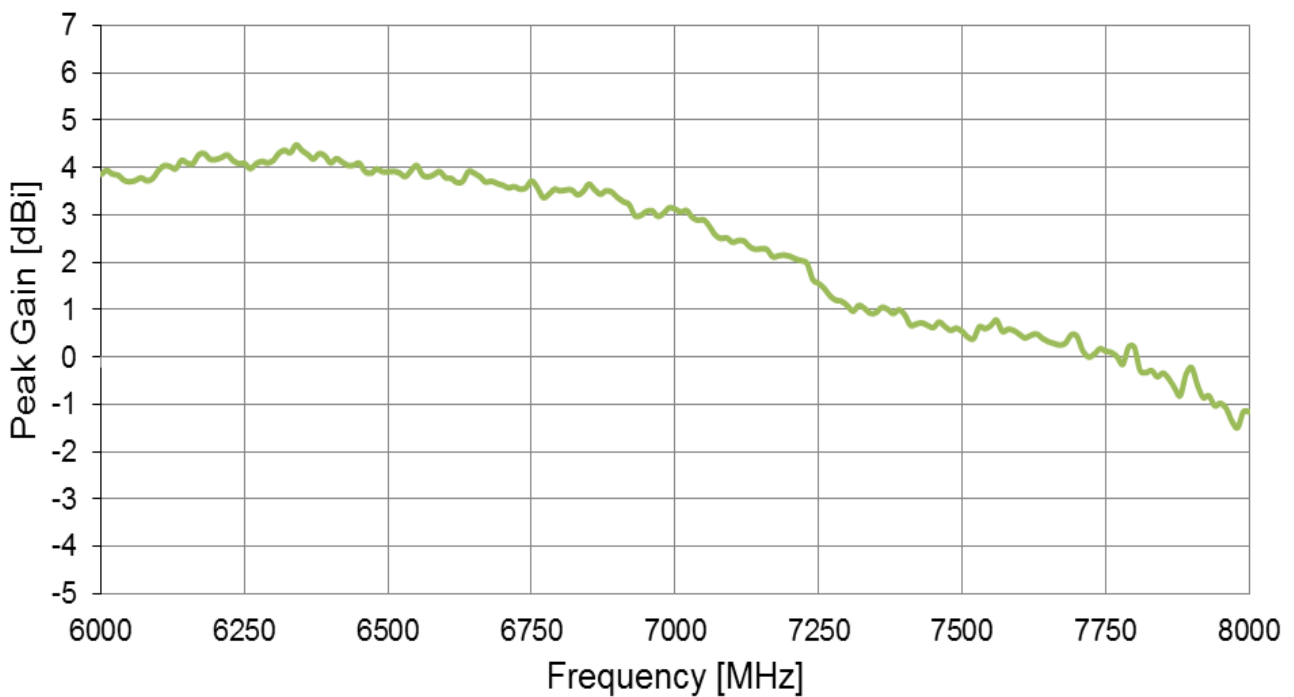

3.5 Average Gain

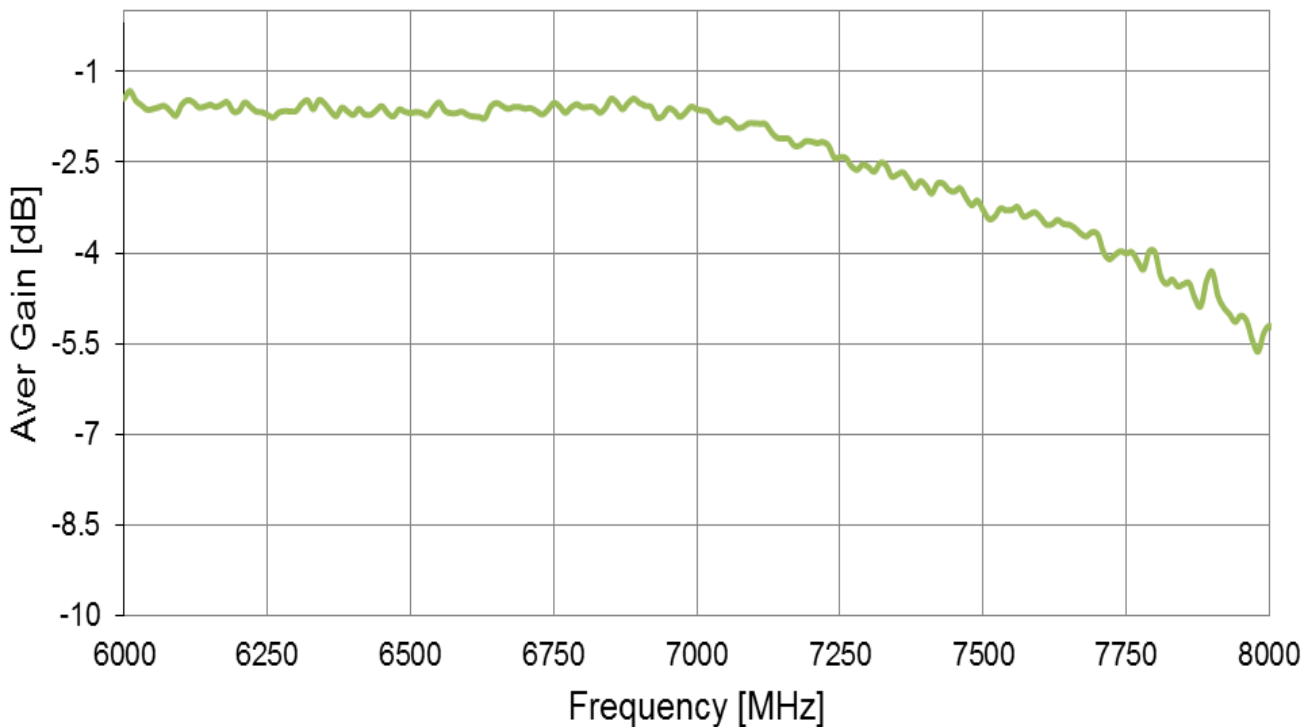

3.6 Group Delay (XY Plane) at 6.5GHz

The Total System Group Delay (in seconds) is the total time delay or transmit time of the amplitude envelopes of the various sinusoidal components of UWB signals through a device or link budget system. Effectively it is the propagation delay in transmitting antenna (Tx), propagation channel (Ch), and in receiving antenna (Rx) summed together.

An even more important parameter is the Group Delay Variation over Theta Angle from an average constant group delay. The group delay ripple is used to quantify this deviation. Ultimately, deviations from a maximally flat or constant group delay represent distortions in the output signal which is undesirable. A group delay variation of 100-150ps or less is considered acceptable for UWB system implementation.

3.7 Group Delay Vs Frequency

The group delay was simulated for two UWC.01 antennas placed at a far-field distance of 1m distance. One of the antennas was kept stationary, while the other was rotated in 45° intervals.

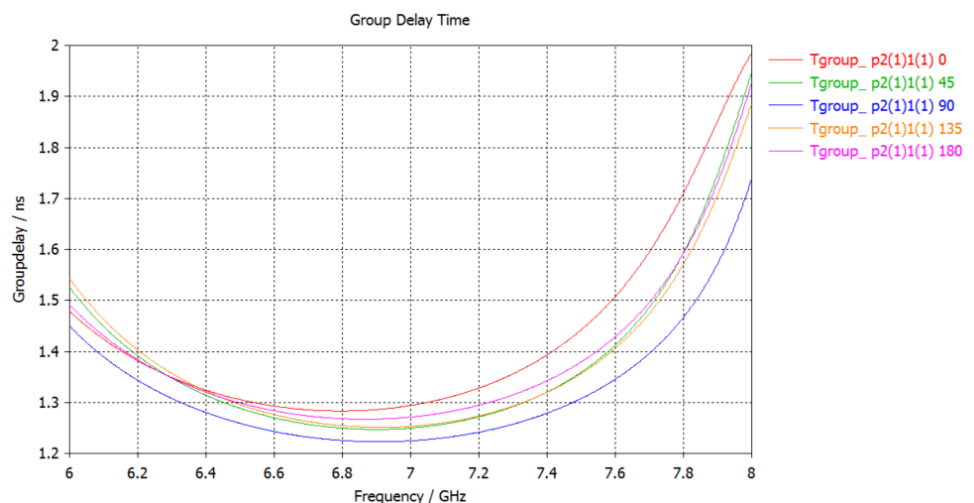

3.8 Group Delay Vs Theta at 6.5GHz

The calculated Maximum difference between the highest value and the lowest Group Delay value is presented below. The UWC.01 antenna presents Group Delay variation smaller than 100 ps (benchmark) from 6GHz up to 7.3GHz spanning UWB channels 5-7.

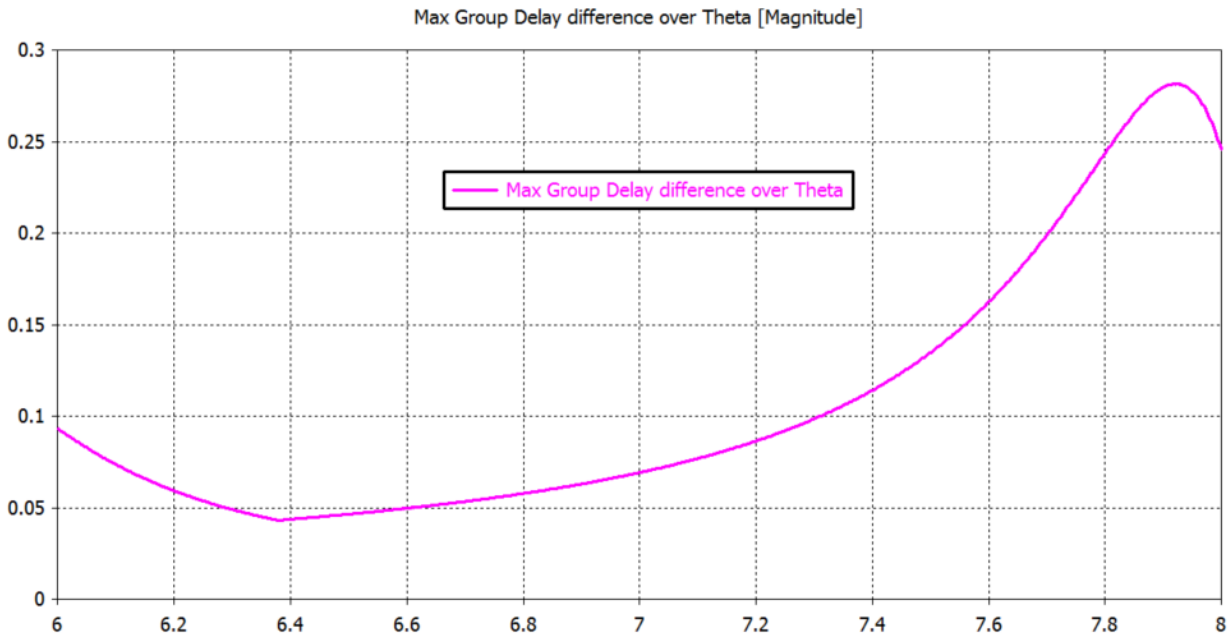

3.9 Fidelity Factor vs. Theta Angle

The fidelity is above 0.9 (benchmark value) for all Theta angles, therefore UWC.01 shows very good performance.

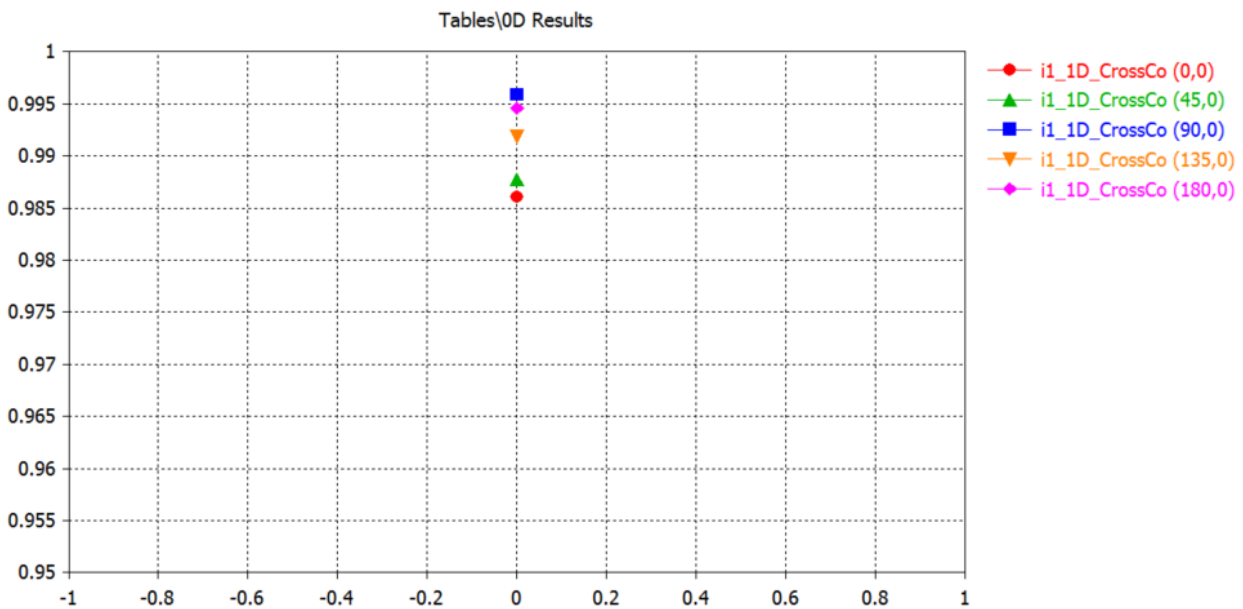

4. Radiation Patterns

4.1 Test Setup

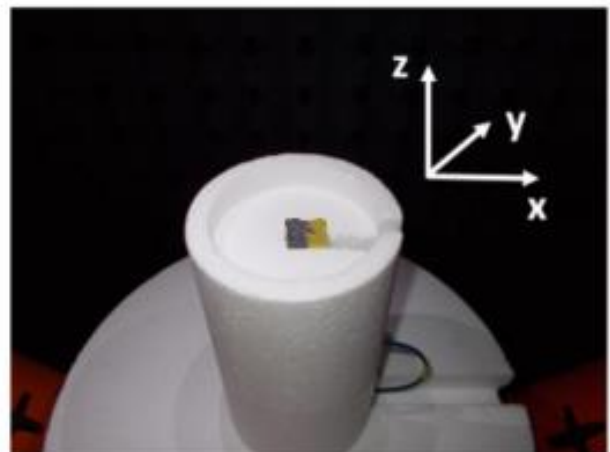
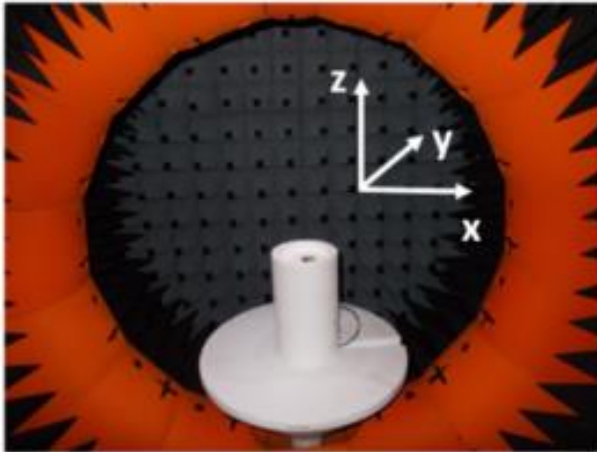

Chamber Set-up Free space

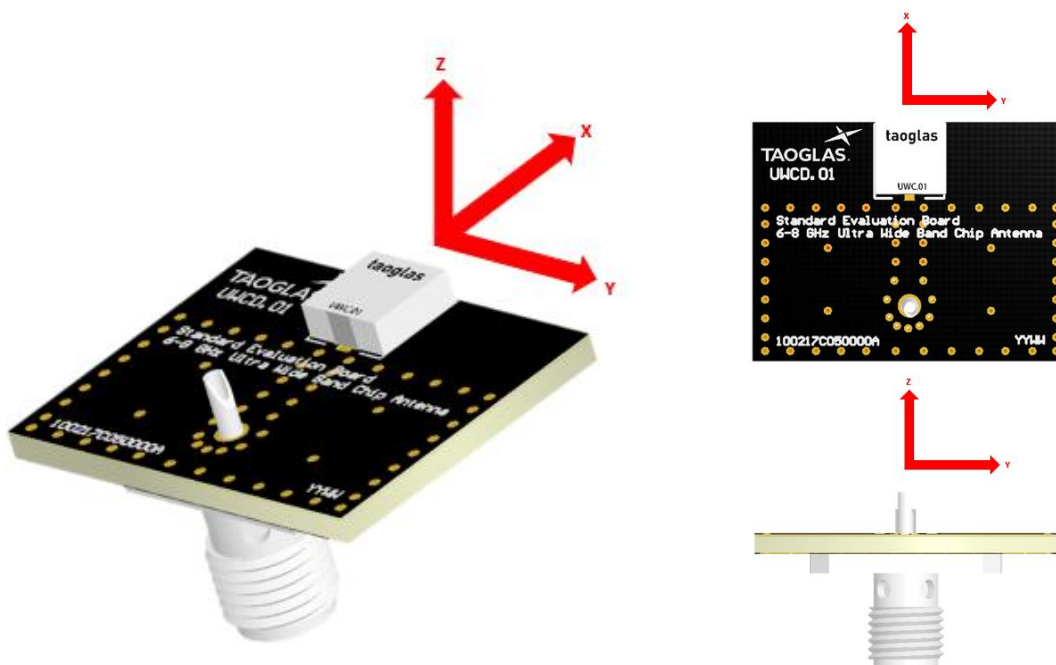

Illustration of UWC.01 in X,Y,Z

4.2 3D and 2D Radiation Patterns

6GHz

7GHz

8GHz

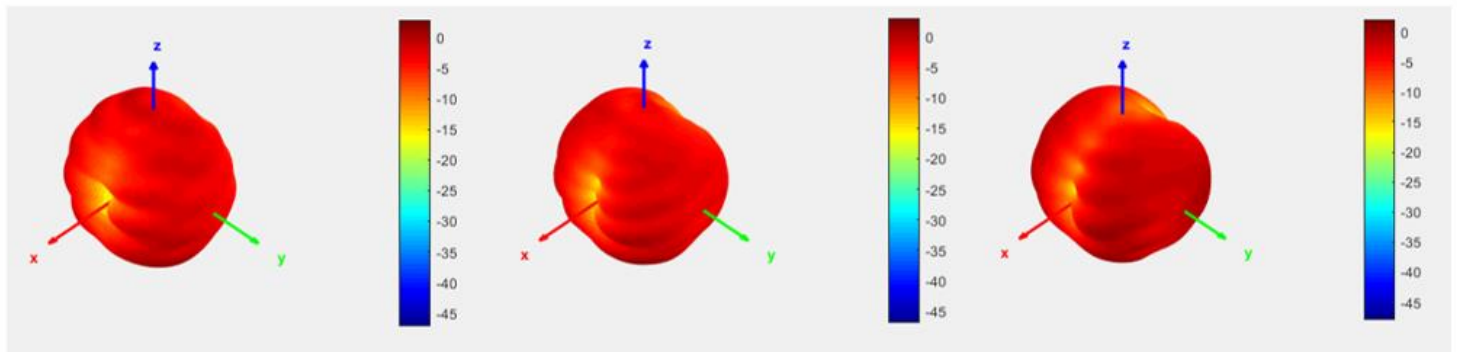

XY Plane

XZ Plane

YZ Plane

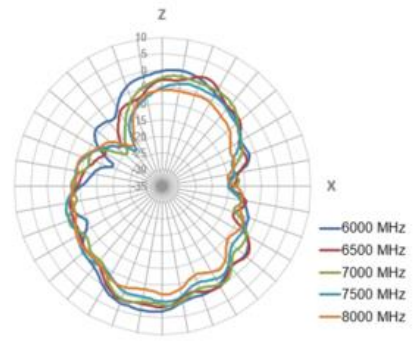
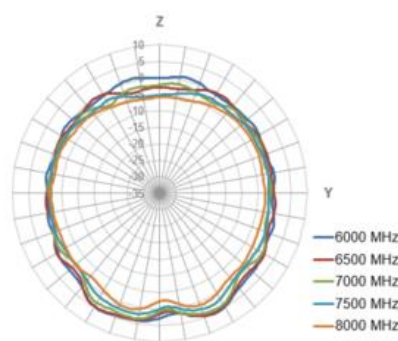
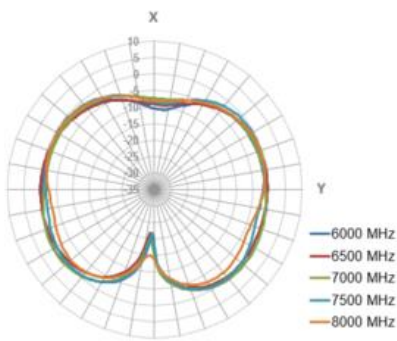

5. Mechanical Drawing (Units: mm)

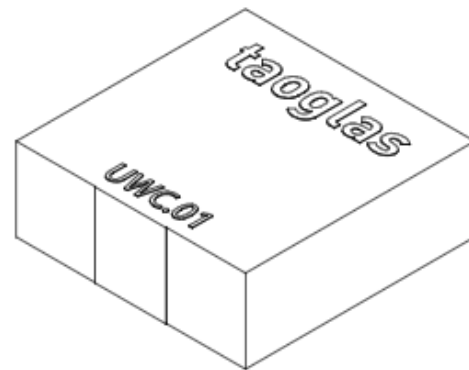

ISOMETRIC VIEW

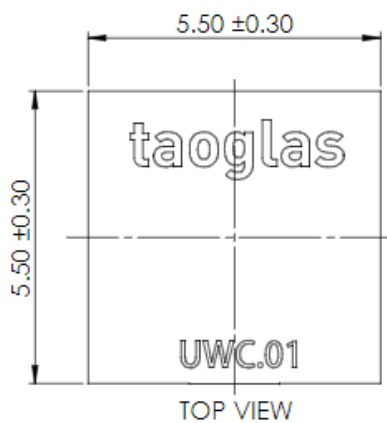

TOP VIEW

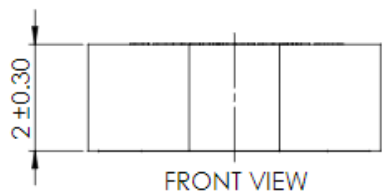

FRONT VIEW

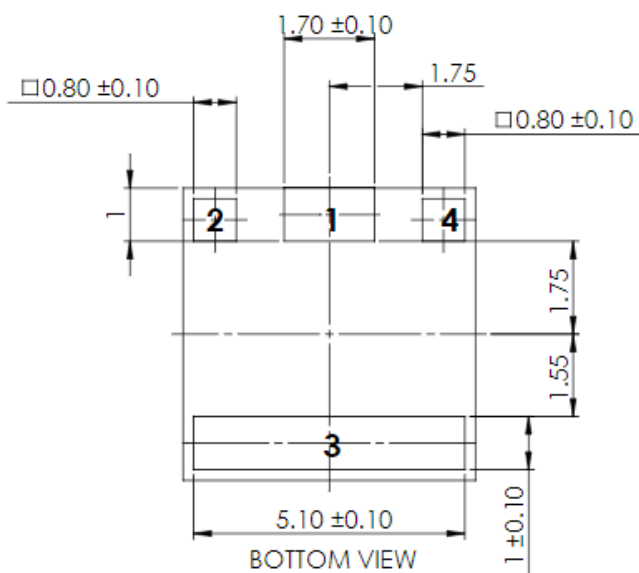

BOTTOM VIEW

<u>PIN:</u>	<u>DESCRIPTION:</u>
1	Feed (50 ohm)
2,3,4	NC

12/17/16

6. Antenna Intergration Guide

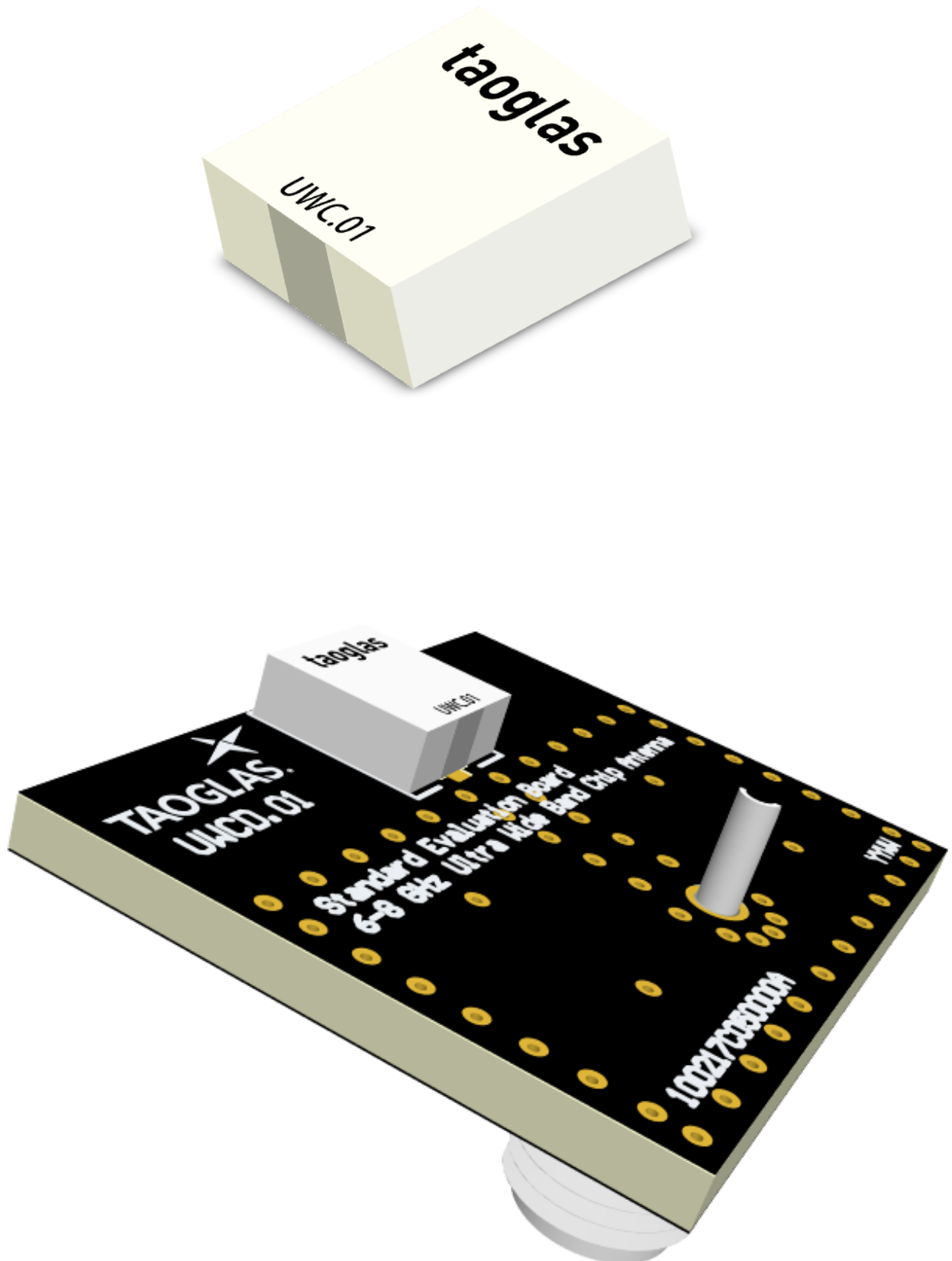

6.1 Schematic Symbol and Pin Definition

The circuit symbol for the antenna is shown below. The antenna has 4 pins with only one pin (Pin 1) as functional. Pins 2, 3 and 4 are for mechanical strength.

Pin	Description
1	RF Feed
2,3, 4	Mechanical, Not Connected

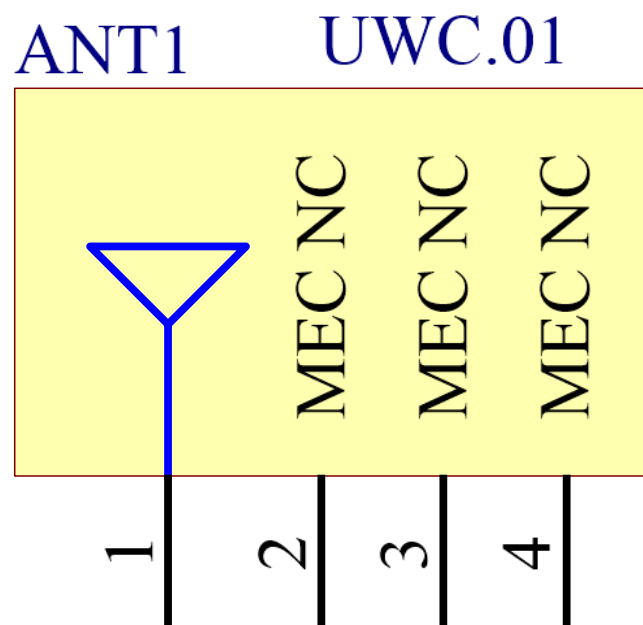

6.2 Antenna Integration

Whatever the size of the PCB, the antenna should ideally be placed on the PCB's longer side, to take advantage of the ground plane.

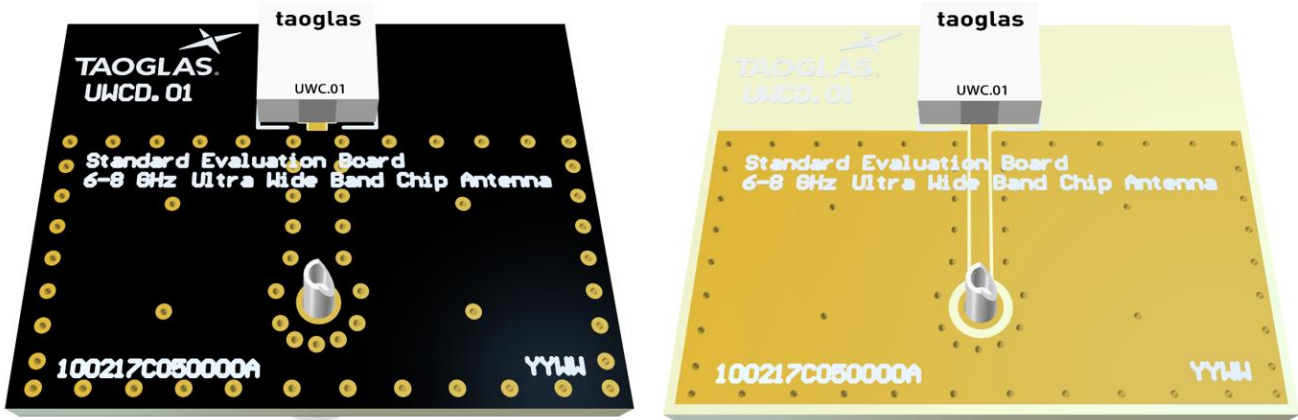

6.3 PCB Layout

The footprint and clearance on the PCB must meet the antenna specification. An example of the PCB layout shows the antenna footprint with clearance.

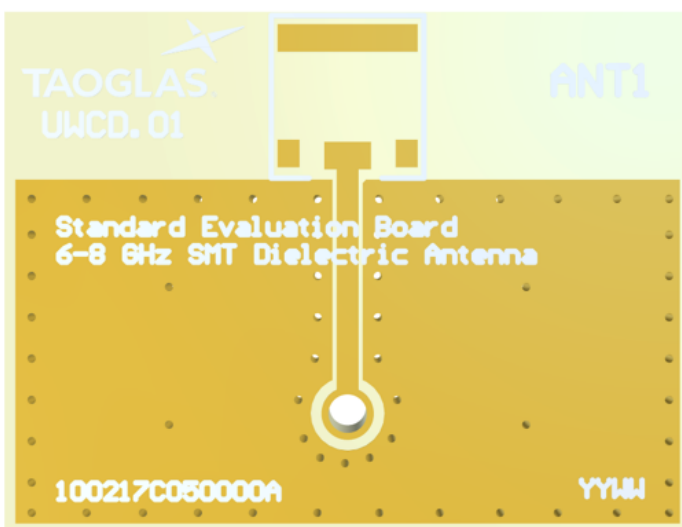

Topside

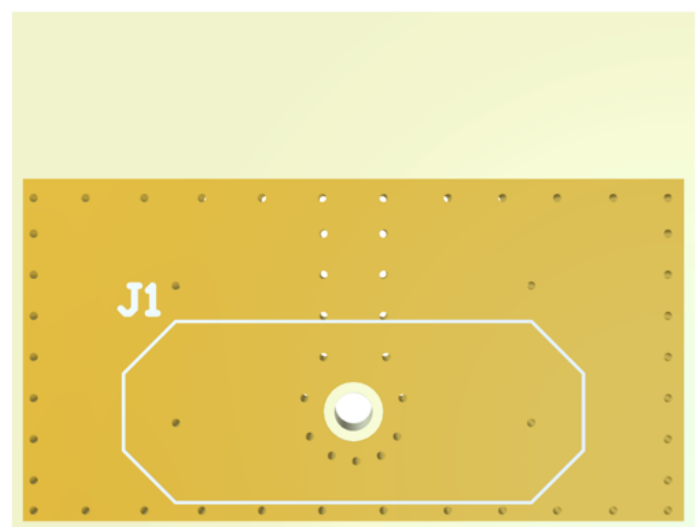

Bottom Side

6.4 PCB Keep Out

Below shows the antenna footprint and clearance through ALL layers on the PCB. Only the antenna pads and connection to feed are present within this clearance area (marked RED). The clearance area extends to 1.3mm from the top of the lower antenna mechanical pads to the ground area and 4.5mm from the top of the upper mechanical pad. This clearance area includes the bottom side and ALL internal layers on the PCB.

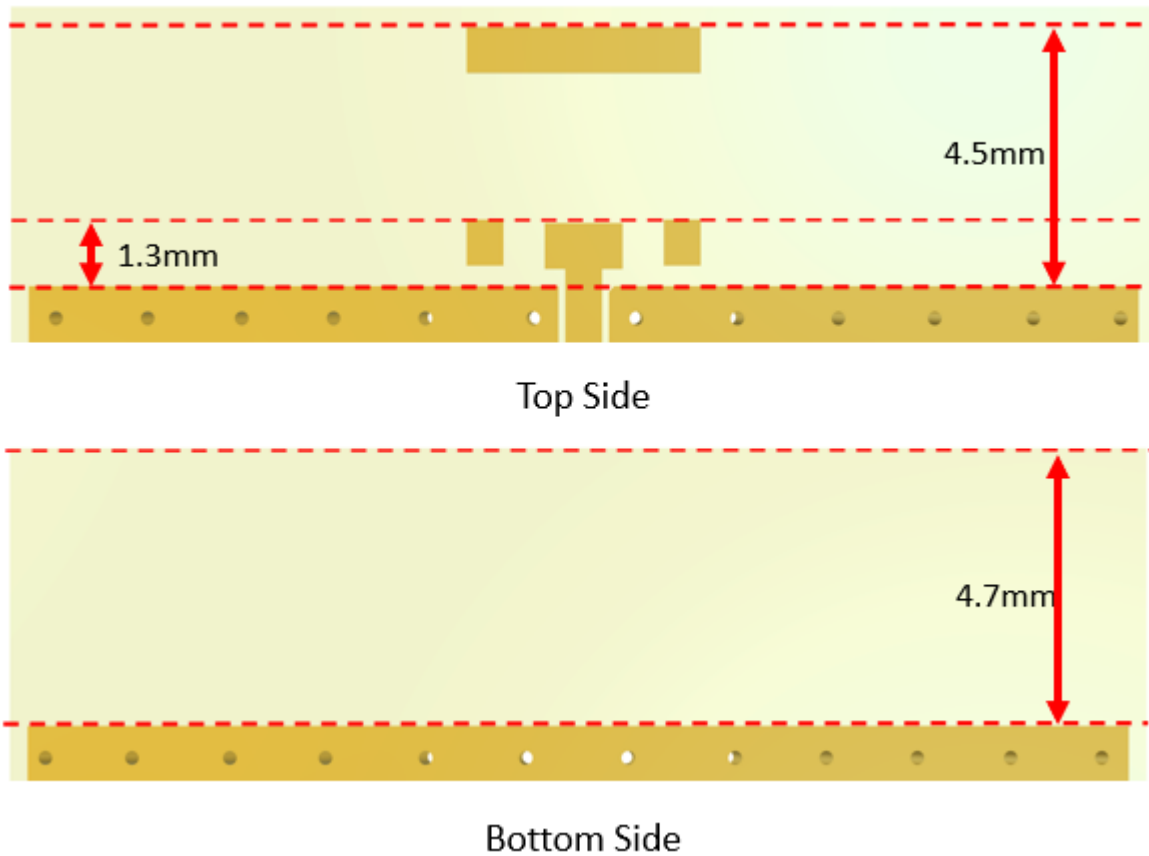

6.5 Evaluation Board

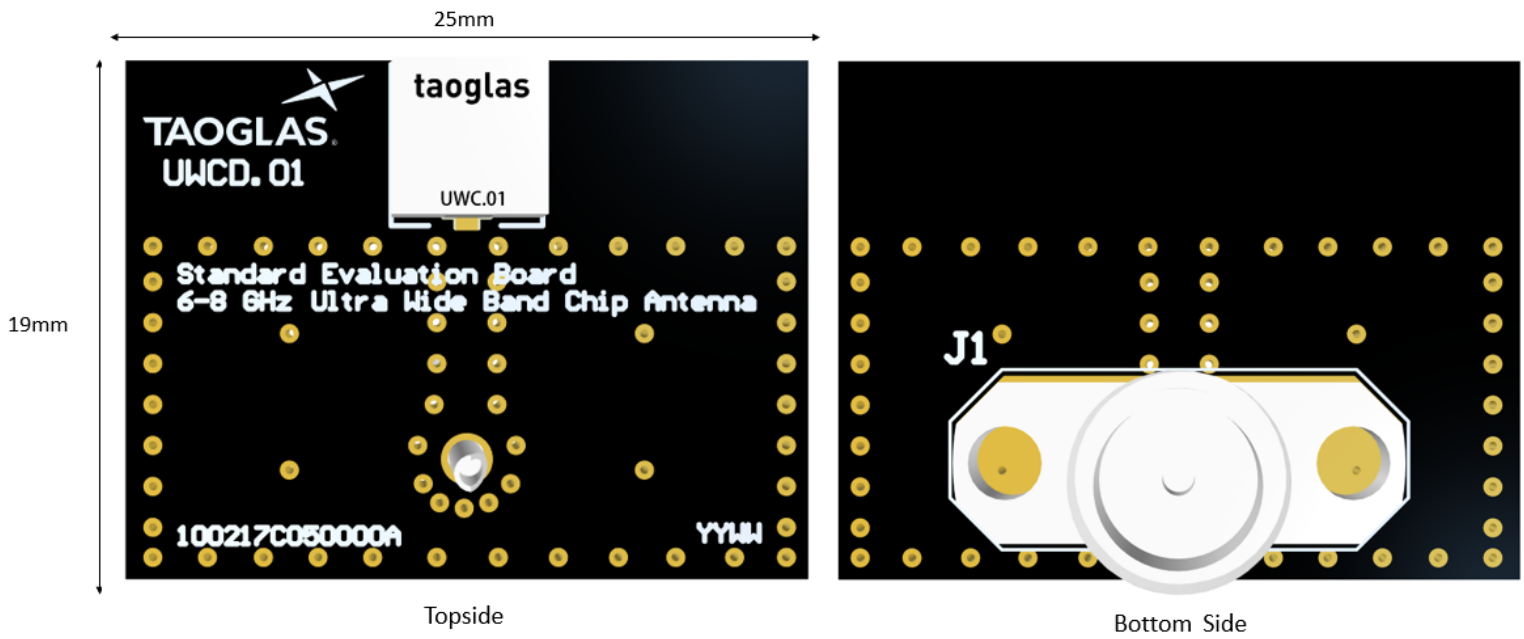

6.6 Evaluation Board Ground Plane Length

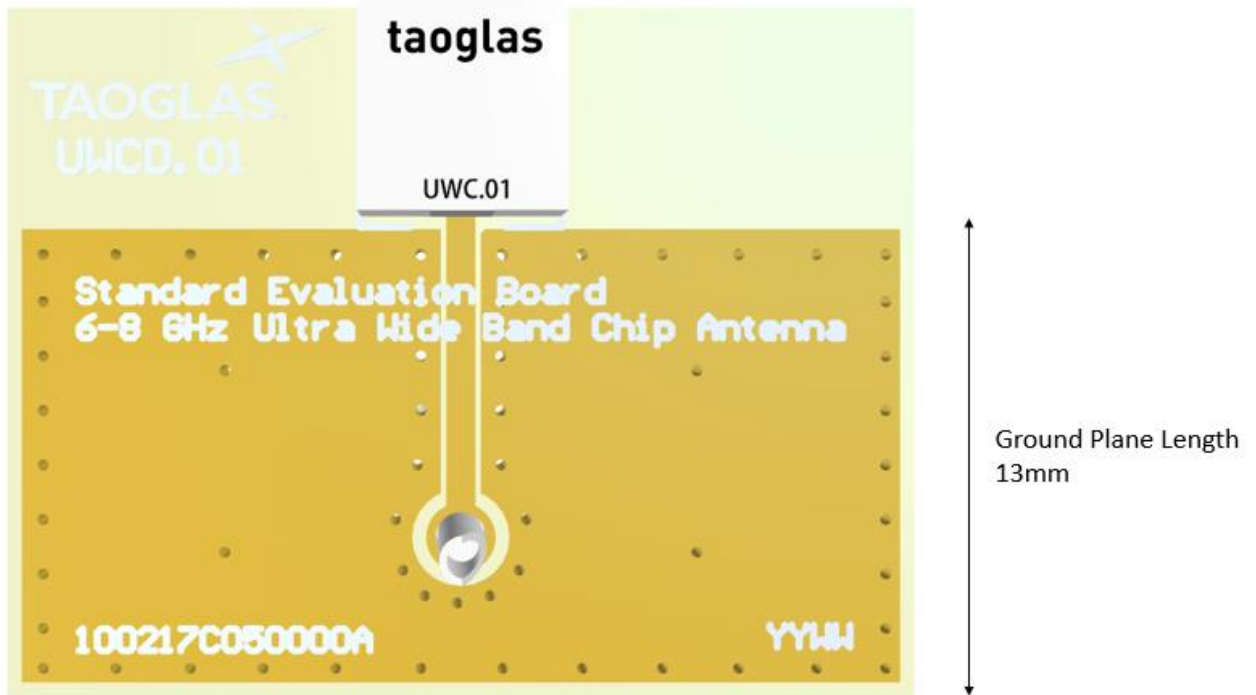

6.7 Tuning Stub for Impedance Matching Instead of Pi-Matching Circuit

The tuning stub is shown below. It is an extension of the ground plane (copper) into the clearance area around the UWC.01. The stub can be used instead of the matching circuit to achieve good impedance matching at 6.5-8GHz.

The results show it is possible to use a Tuning Stub instead of a Pi-matching-circuit, although it is possible to better match at 6.5GHz with the Pi-matching-circuit. The measurements also show that once the antenna is matched with a Pi-matching circuit the stub on left or right does not influence the result significantly. However adding stubs simultaneously to left and right will negatively influence antenna performance.

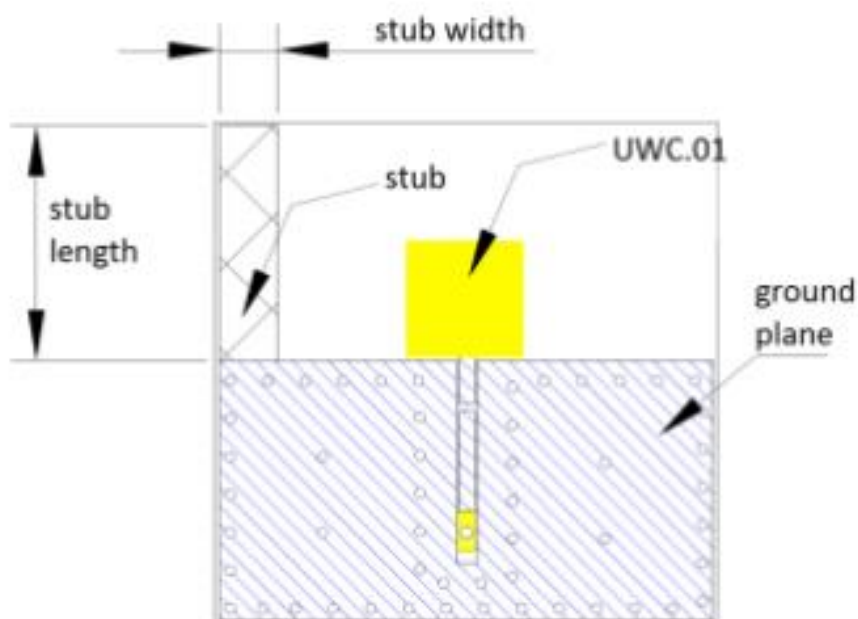

6.8 Footprint

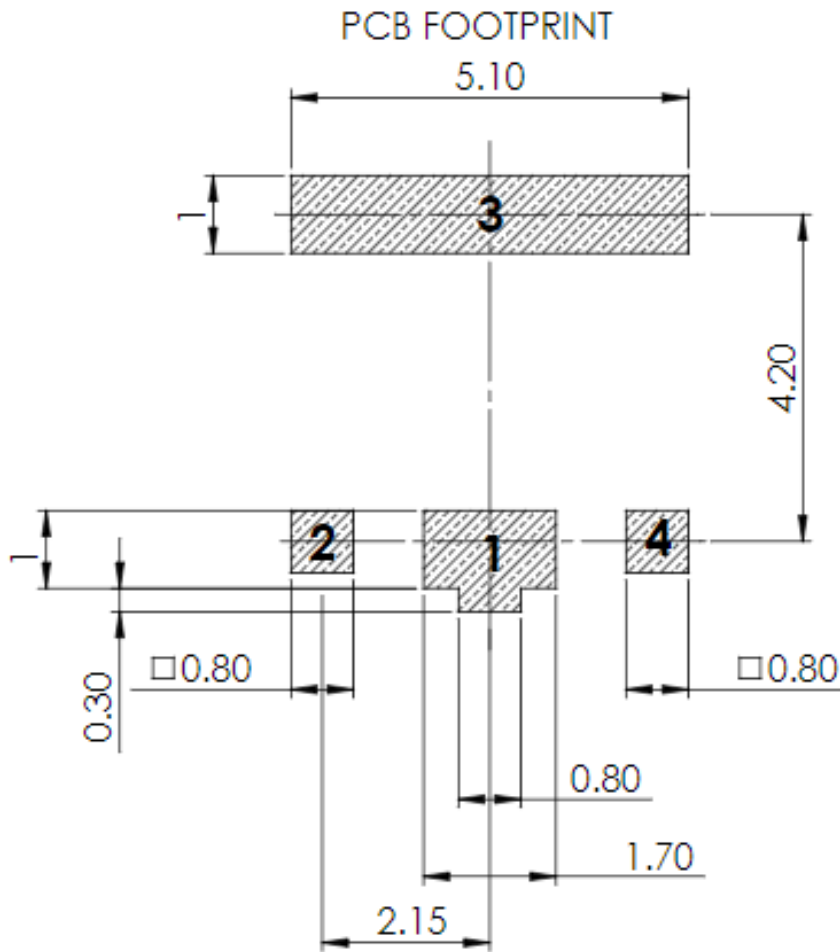

<u>PIN:</u>	<u>DESCRIPTION:</u>
1	Feed (50 ohm)
2,3,4	NC

7. Packaging

1200 pc UWC.01 per reel
 Dimensions - Ø330*20.4mm
 Weight - 583g

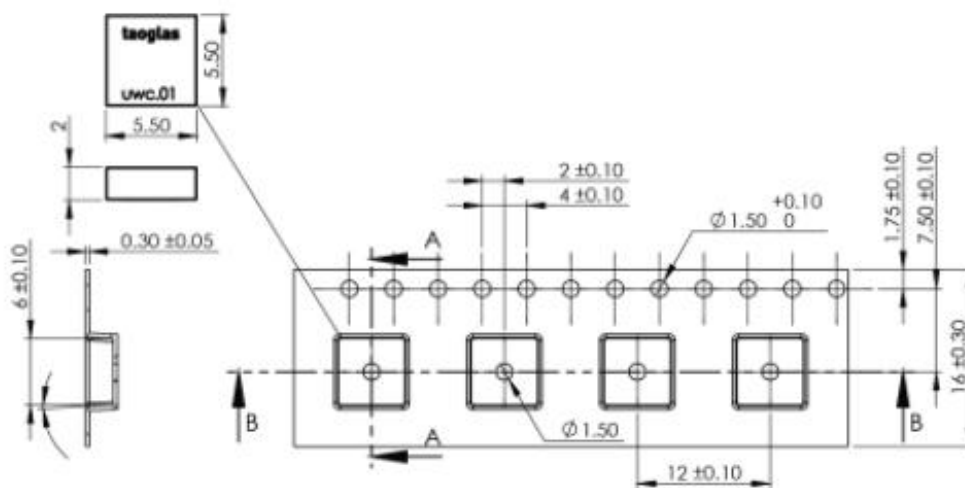

1200 pcs UWC.01 reel
 Dimensions - 330*330*20.4mm
 Weight - 583g

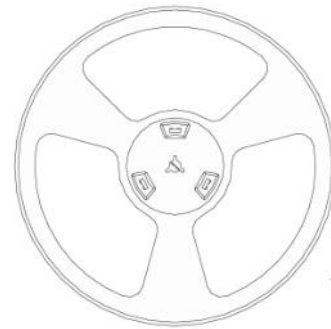

1200 pcs UWC.01 / 1 Reel in small box
 Dimensions - 350*340*47mm
 Weight - 0.86Kg

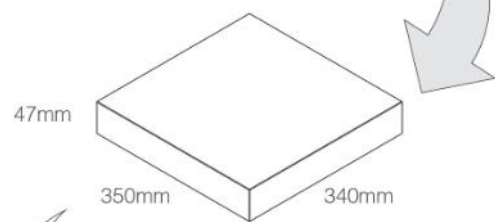

5 small boxes, 6000 pcs in one carton
 Carton Dimensions - 360*370*275mm
 Weight - 4.3Kg

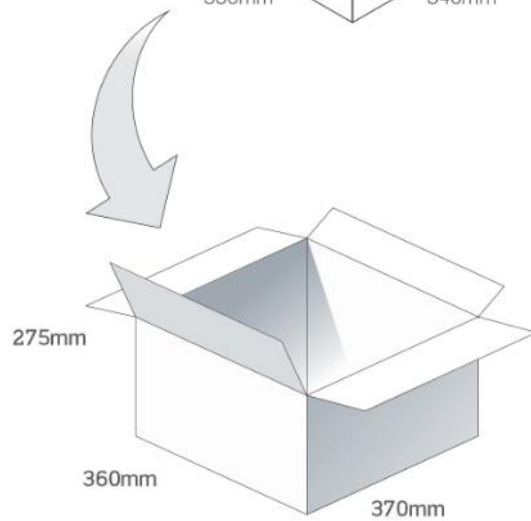

8. Solder Reflow Profile

UWC.01 can be assembled following Pb-free assembly. According to the Standard IPC/JEDEC J-STD-020C, the temperature profile suggested is as follows:

Phase	Profile Features	Pb-Free Assembly (SnAgCu)
PREHEAT	Temperature Min(T_{smin}) Temperature Max(T_{smax}) Time(t_s) from (T_{smin} to T_{smax})	150°C 200°C 60-120 seconds
RAMP-UP	Avg. Ramp-up Rate (T_{smax} to TP)	3°C/second(max)
REFLOW	Temperature(T_L) Total Time above T_L (t_L)	217°C 30-100 seconds
PEAK	Temperature(T_P) Time(t_p)	260°C 2-5 seconds
RAMP-DOWN	Rate	3°C/second(max)
Time from 25°C to Peak Temperature		8 minutes max.
Composition of solder paste		96.5Sn/3Ag/0.5Cu
Solder Paste Model		SHENMAO PF606-P26

The graphic shows temperature profile for component assembly process in reflow ovens

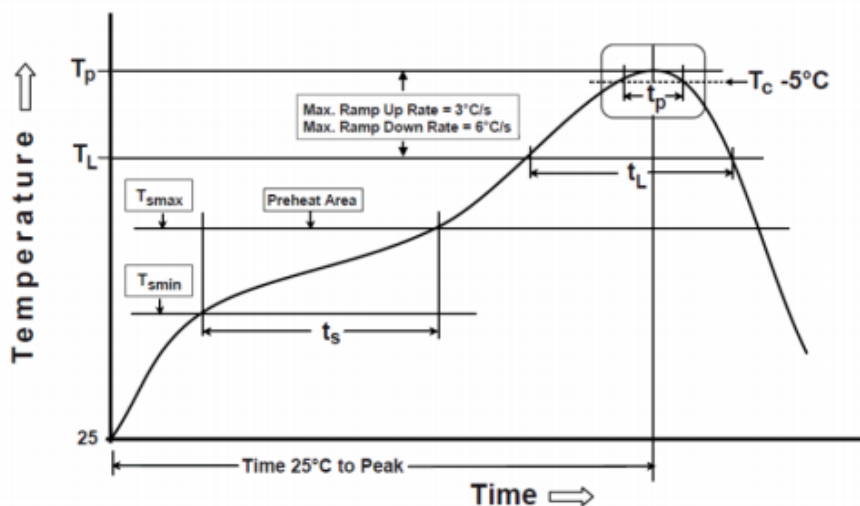

Soldering Iron condition: Soldering iron temperature $270^{\circ}\text{C} \pm 10^{\circ}\text{C}$.

Apply preheating at 120°C for 2-3 minutes. Finish soldering for each terminal within 3 seconds, if soldering iron temperature over $270^{\circ}\text{C} \pm 10^{\circ}\text{C}$ or 3 seconds, it will make cause component surface peeling or damage.

Changelog for the datasheet

SPE-17-8-055 – UWC.01

Revision: E (Current Version)

Date:	2022-06-08
Changes:	Antenna temperature range updated. (ISO16750-4 - 5.1.2.2)
Changes Made by:	Gary West

Previous Revisions

Revision: D

Date:	2022-04-28
Changes:	Added Solder Reflow profile
Changes Made by:	Jack Conroy

Revision: C

Date:	2021-09-27
Changes:	MSL information added and fixed formatting.
Changes Made by:	Erik Landi

Revision: B

Date:	2021-06-16
Changes:	New template update & Added integration guide.
Changes Made by:	Gary West

Revision: A (Original First Release)

Date:	2017-09-12
Notes:	
Author:	Andela Zaric



TAOGLAS®

www.taoglas.com

