



TAOGLAS®



Datasheet

Apex TG.66

Part No:
TG.66.A113

Description:

5G/4G Wideband Terminal Mount Monopole Antenna
With Rotatable Hinge SMA(M) Connector

Features:

600-6000MHz Wideband 5G/4G Cellular Antenna
Fantastic Efficiency Across all Bands
Super Small Form Factor with Rotatable Hinged Design for Flexible Positioning
Monopole Antenna Design Suitable for Small Ground Plane
Omnidirectional Gain Patterns for Optimum Coverage
Connector: SMA Male Straight
Dimensions: 70.3 * Ø10 mm
RoHS and REACH Compliant

1. Introduction	3
2. Specifications	4
3. Antenna Characteristics	6
4. Radiation Patterns	9
5. Mechanical Drawing	20
6. Packaging	21
<hr/>	
Changelog	22

Taoglas makes no warranties based on the accuracy or completeness of the contents of this document and reserves the right to make changes to specifications and product descriptions at any time without notice. Taoglas reserves all rights to this document and the information contained herein. Reproduction, use or disclosure to third parties without express permission is strictly prohibited.



1. Introduction



The Taoglas TG.66 is a hinged monopole antenna designed to cover all global 5G/4G frequencies between 600MHz and 6GHz. Despite its miniature size, just 70.3 x Ø10mm, the TG.66 has omnidirectional radiation patterns and provides stable gain across the hemisphere. The TG.66 is supplied with a rotatable 90° hinged SMA connector meaning can be covertly installed on all types of gateways and routers at straight or bent angles. The TG.66 performs excellently at 5G bands with efficiencies above 45% across the entire 5G/4G spectrum when positioned on the edge of a small ground plane of just 120 x 45mm in size.

The TG.66 utilizes a sleek, robust PC enclosure, and its' small size allows is to be mounted where space is at a premium. The SMA (M) connector's hinge mechanism allows the antenna to be rotated into the preferred orientation which helps to avoid other antennas or objects. This also helps with isolation by pointing the antennas in different directions when used in MIMO systems or when other antennas are present on the same device. The TG.66 has been evolved from the highly successful TG.09 and is part of the ever-growing portfolio of 5G antennas offered by Taoglas.

Typical Applications include:

- Gateways and Routers
- IoT Sensors
- Public Safety and Security
- Point of Sales Terminals
- Smart Home Automation
- Robotics / Autonomous

The TG.66 comes with an SMA(M) connector as standard and this can be customized subject to MOQ and NRE, contact your regional Taoglas customer support team for more information.

2. Specifications

Electrical

Band	Frequency (MHz)		Efficiency (%)	Average Gain (dB)	Peak Gain (dBi)	Impedance	Max Input Power	Polarization	Radiation Pattern
5G NR/4G Band 71	617~698	Straight	73.5	-1.3	1.9	50 Ω	10W	Linear	Omni-Directional
		Bent	61.5	-2.1	1.4				
4G/3G Band 12,13,14,17,28,29	698~824	Straight	79.5	-1	2.6				
		Bent	79	-1	2.6				
4G/3G/NB-IoT/Cat M Band 5,8,18,19,20,26,27	824~960	Straight	61.8	-2.1	2.4				
		Bent	64.2	-1.9	2				
5G NR/4G Band 21,32,74,75,76	1427~1518	Straight	53.8	-2.7	2.8				
		Bent	49.4	-3.1	2.7				
4G/3G Band 1,2,3,4,9,23,25,35,39,66	1710~2200	Straight	56.6	-2.5	2.4				
		Bent	60.8	-2.2	4.2				
4G/3G Band 7,30,38,40,41	2300~2690	Straight	45.1	-3.5	1.3				
		Bent	49.9	-3	4.4				
5G NR/4G Band 22,42,48,77,78,79	3300~5000	Straight	54.9	-2.6	4.8				
		Bent	53.5	-2.7	4.3				
LTE5200/ Wi-Fi 5800	5150~5925	Straight	45.1	-3.5	1.1				
		Bent	56.4	-2.5	2.7				

*Tested on 120 x 45mm Ground Plane

Mechanical

Dimensions	71 * 10mm
Weight	9g
Plastic Material	PC345
Connector	SMA (M) Hinged

Environmental

Temperature Range	-40°C to 85°C
-------------------	---------------

5G/4G Bands			
Band Number	5G NR / FR1 / LTE / LTE-Advanced / WCDMA / HSPA / HSPA+ / TD-SCDMA		
	Uplink	Downlink	Covered
1	UL: 1920 to 1980	DL: 2110 to 2170	✓
2	UL: 1850 to 1910	DL: 1930 to 1990	✓
3	UL: 1710 to 1785	DL: 1805 to 1880	✓
4	UL: 1710 to 1755	DL: 2110 to 2155	✓
5	UL: 824 to 849	DL: 869 to 894	✓
7	UL: 2500 to 2570	DL: 2620 to 2690	✓
8	UL: 880 to 915	DL: 925 to 960	✓
9	UL: 1749.9 to 1784.9	DL: 1844.9 to 1879.9	✓
11	UL: 1427.9 to 1447.9	DL: 1475.9 to 1495.9	✓
12	UL: 699 to 716	DL: 729 to 746	✓
13	UL: 777 to 787	DL: 746 to 756	✓
14	UL: 788 to 798	DL: 758 to 768	✓
17	UL: 704 to 716	DL: 734 to 746	✓
18	UL: 815 to 830	DL: 860 to 875	✓
19	UL: 830 to 845	DL: 875 to 890	✓
20	UL: 832 to 862	DL: 791 to 821	✓
21	UL: 1447.9 to 1462.9	DL: 1495.9 to 1510.9	✓
22	UL: 3410 to 3490	DL: 3510 to 3590	✓
23	UL: 2000 to 2020	DL: 2180 to 2200	✓
24	UL: 1625.5 to 1660.5	DL: 1525 to 1559	✓
25	UL: 1850 to 1915	DL: 1930 to 1995	✓
26	UL: 814 to 849	DL: 859 to 894	✓
27	UL: 807 to 824	DL: 852 to 869	✓
28	UL: 703 to 748	DL: 758 to 803	✓
29	UL: -	DL: 717 to 728	✓
30	UL: 2305 to 2315	DL: 2350 to 2360	✓
31	UL: 452.5 to 457.5	DL: 462.5 to 467.5	✗
32	UL: -	DL: 1452 - 1496	✓
35		1850 to 1910	✓
38		2570 to 2620	✓
39		1880 to 1920	✓
40		2300 to 2400	✓
41		2496 to 2690	✓
42		3400 to 3600	✓
43		3600 to 3800	✓
48		3550 to 3700	✓
66	UL: 1710-1780	DL: 2110-2200	✓
71		617 to 698	✓
74/75/76		1427 to 1518	✓
77		3300 to 4200	✓
78		3300 to 3800	✓
79		4400 to 5000	✓

3. Antenna Characteristics

3.1 Return Loss

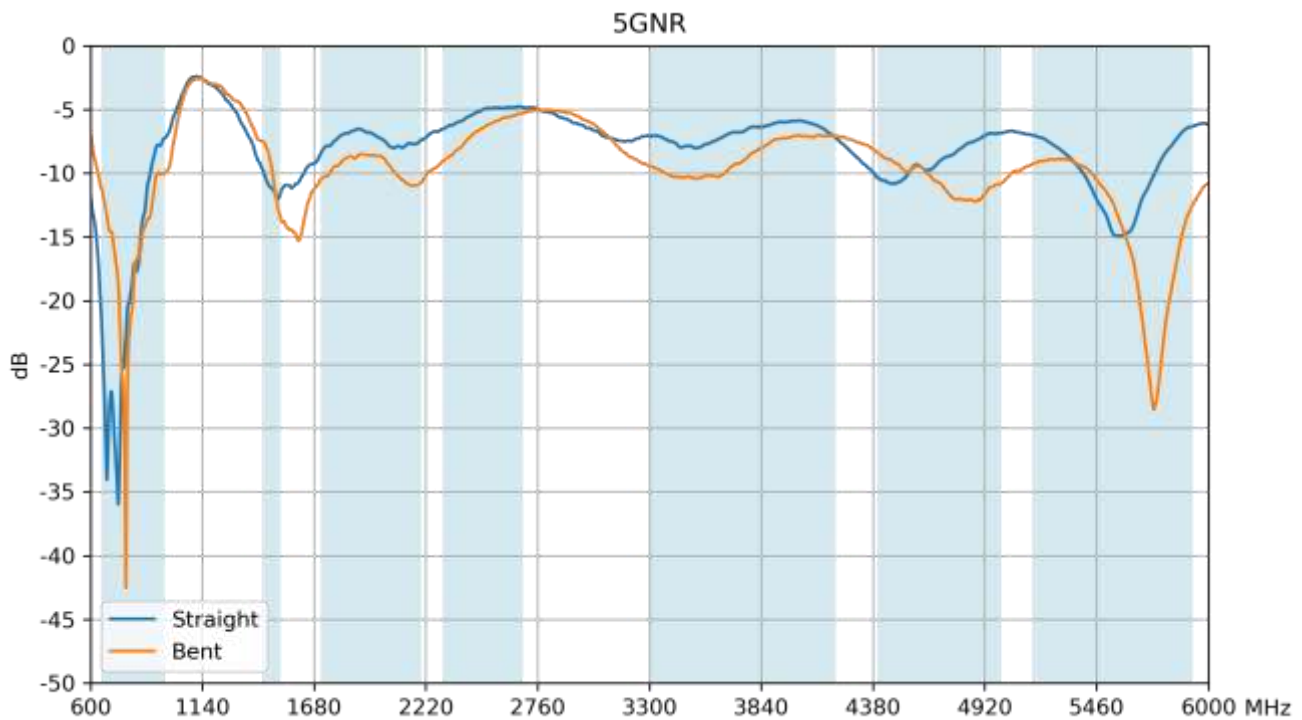

3.2 VSWR

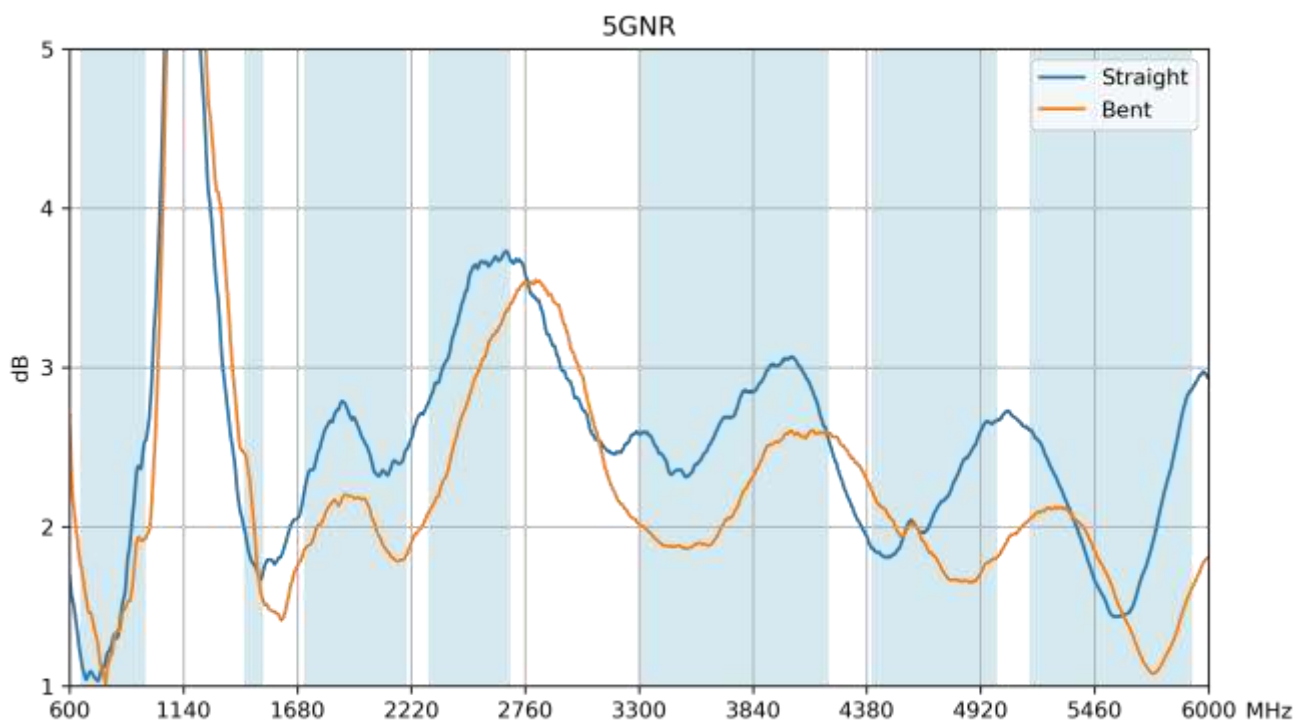

3.3 Efficiency

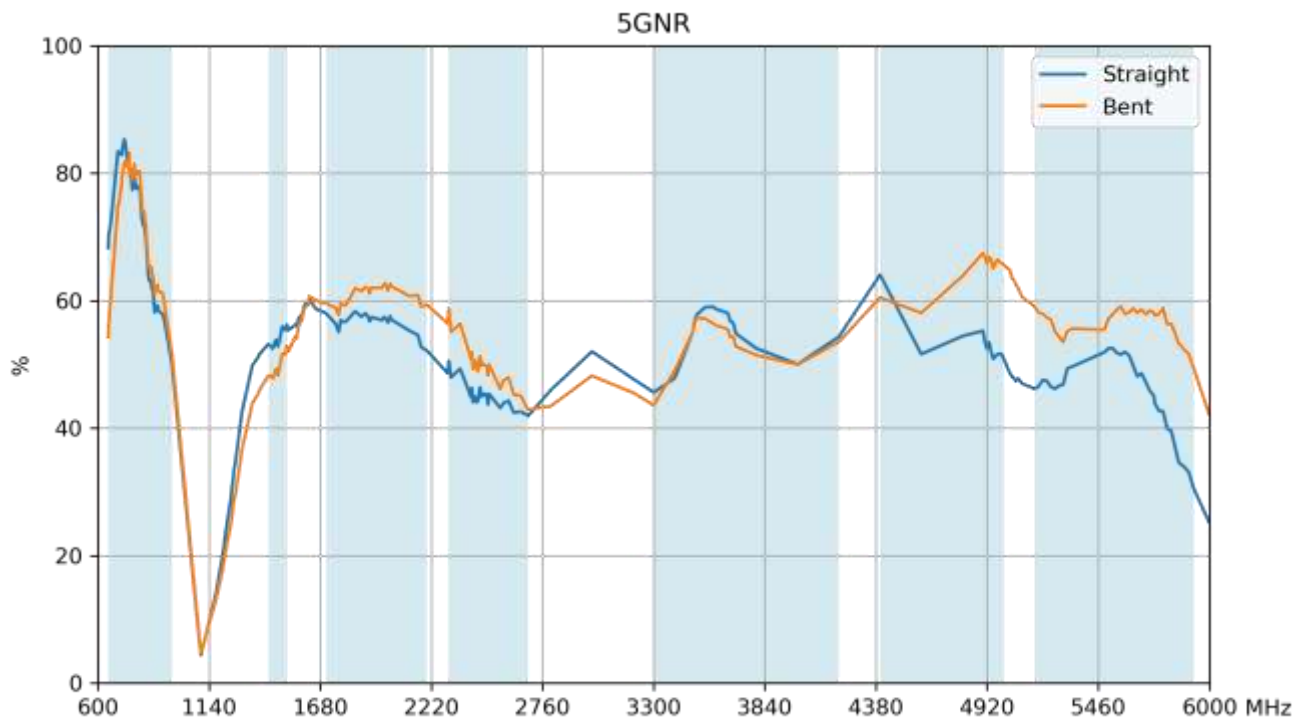

3.4 Peak Gain

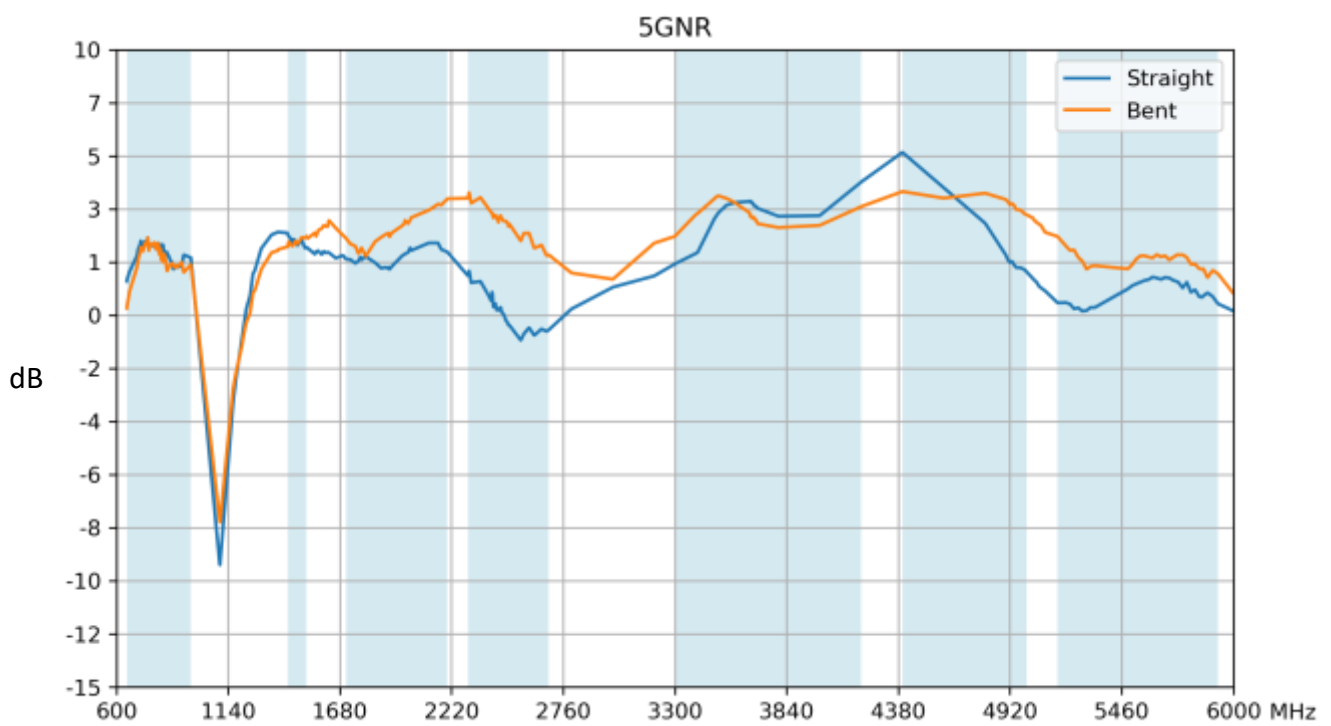

3.5 Average Gain

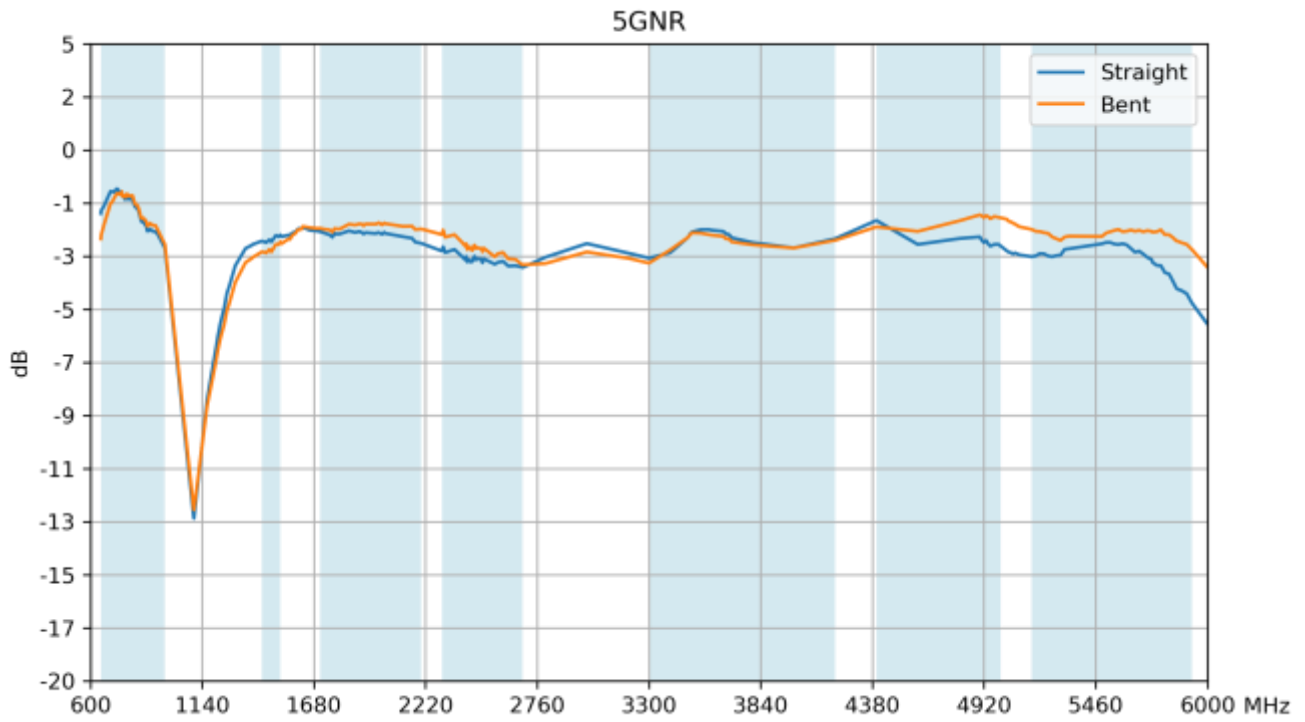

4. Radiation Patterns

4.1 Test Setup

Straight

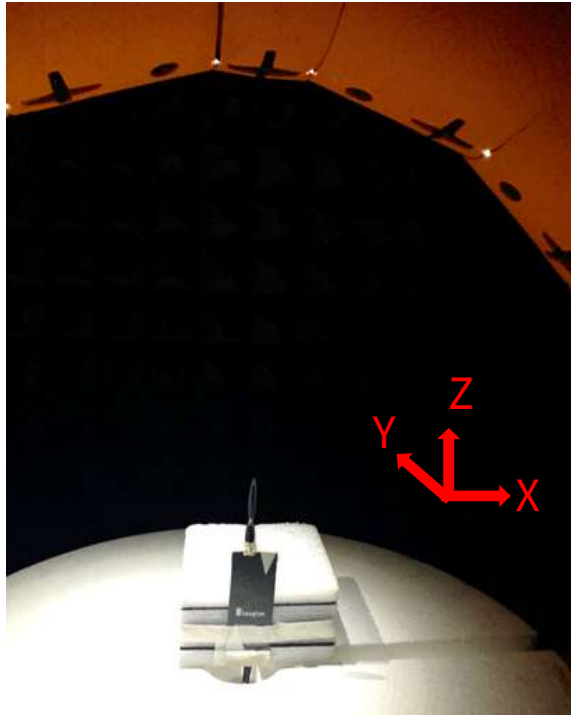

Bent

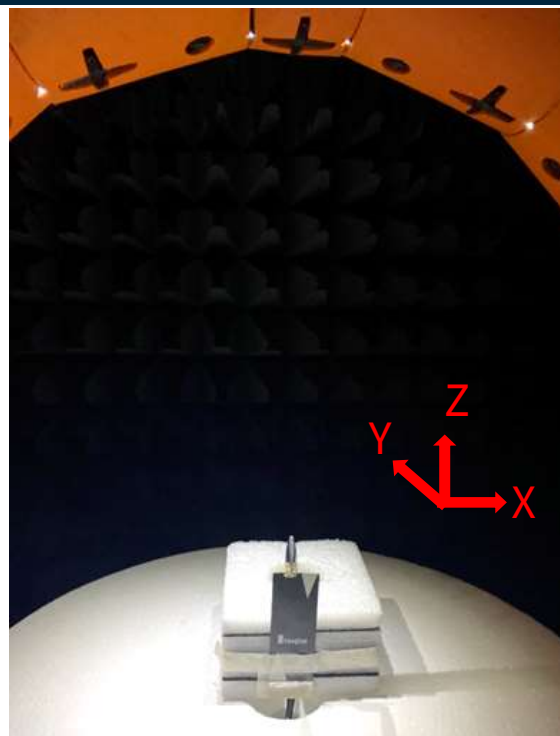

4.2 3D and 2D Radiation Patterns – Straight

663MHz

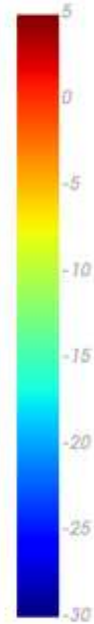
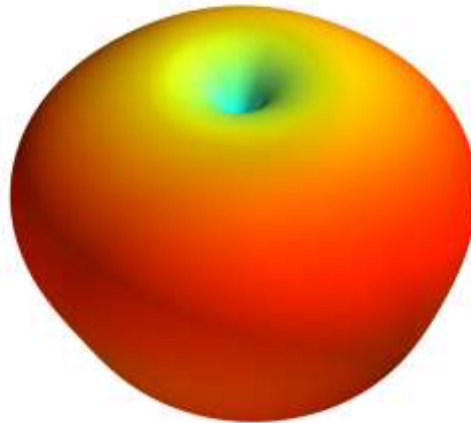

XY Plane

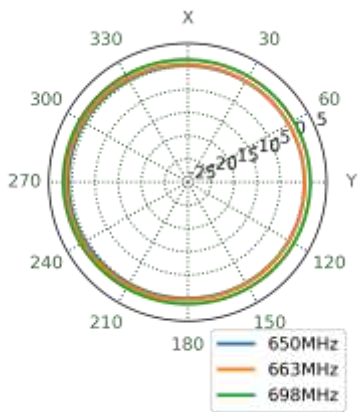

XZ Plane

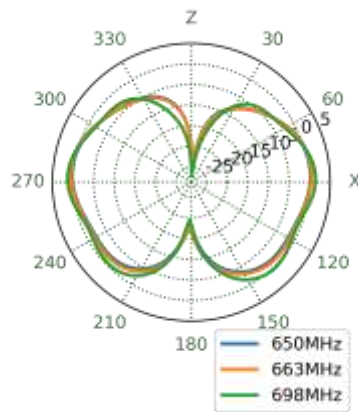

YZ Plane

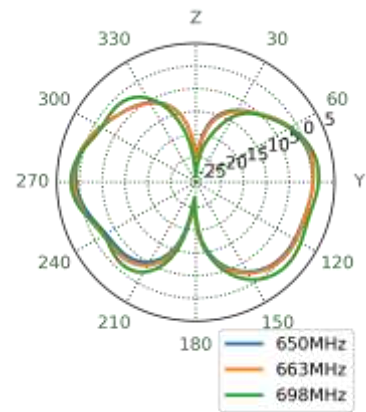

751MHz

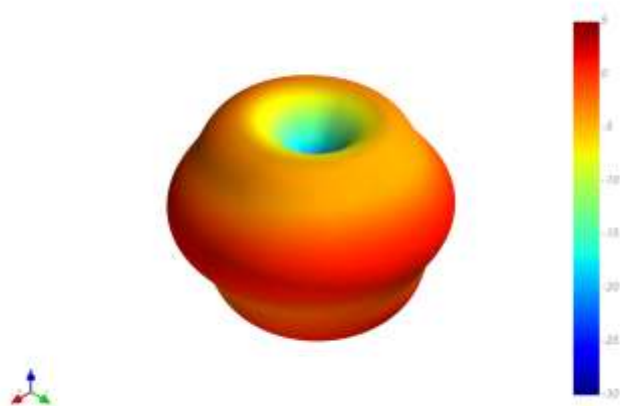

XY Plane

XZ Plane

YZ Plane

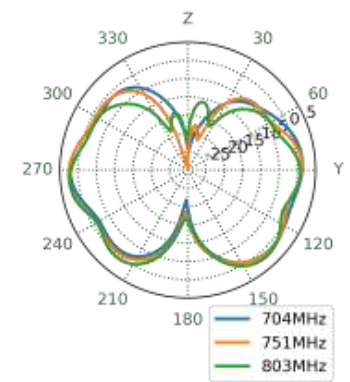
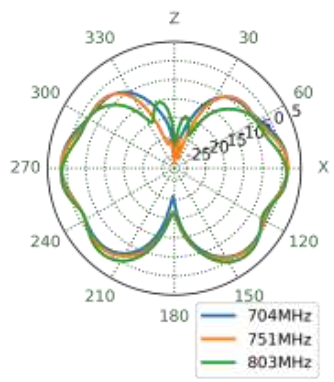
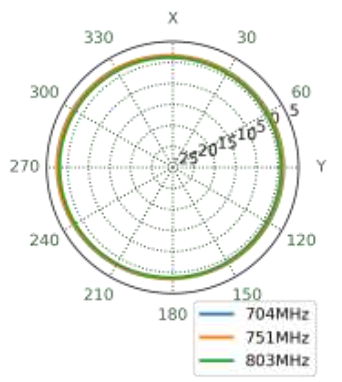

894MHz

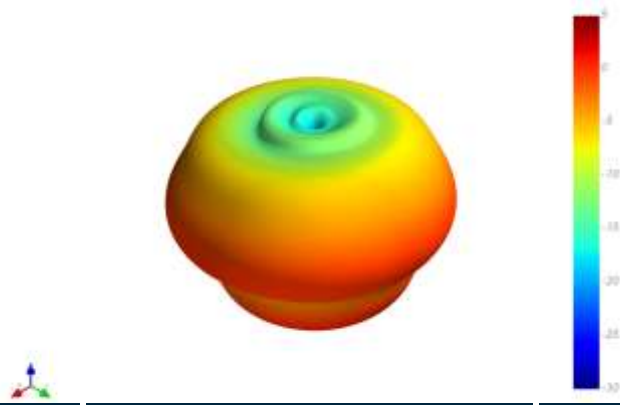

XY Plane

XZ Plane

YZ Plane

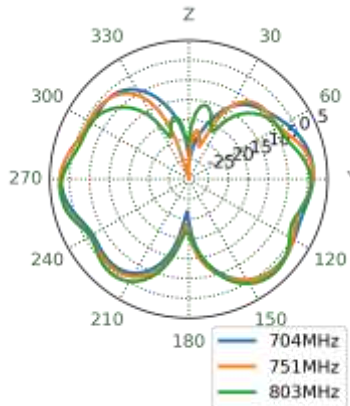
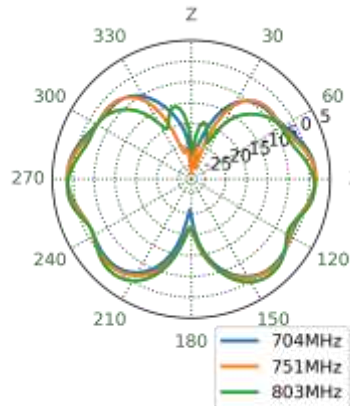
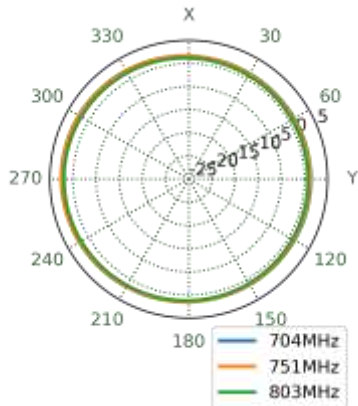

1470MHz

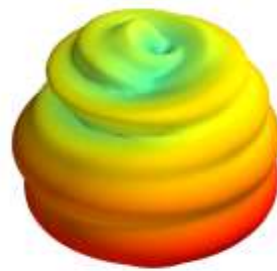

XY Plane

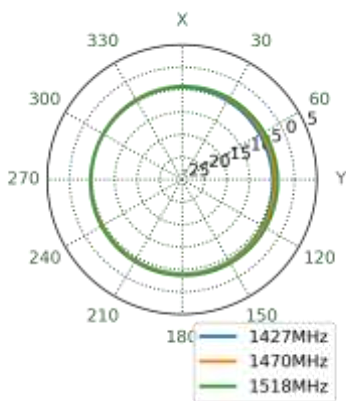

XZ Plane

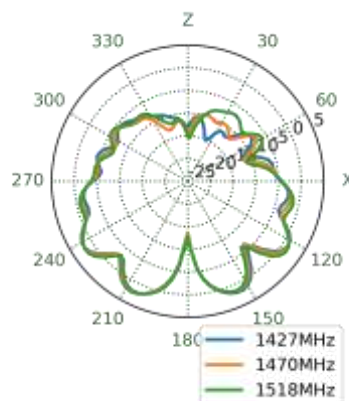

YZ Plane

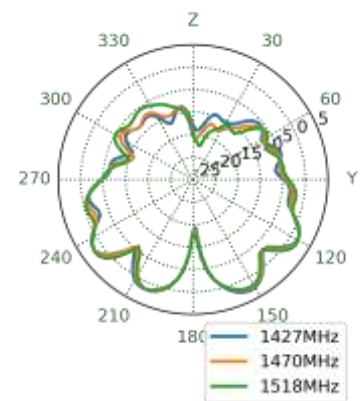

1850MHz

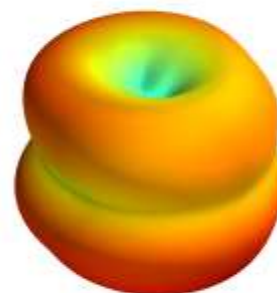

XY Plane

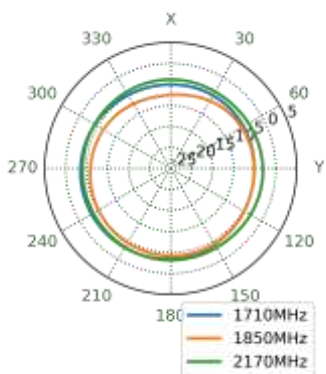

XZ Plane

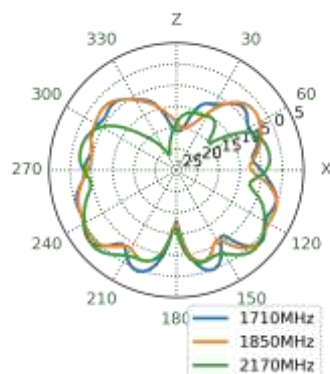

YZ Plane

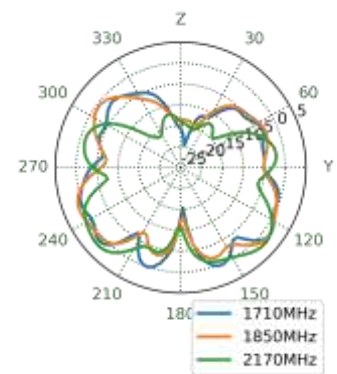

2496MHz

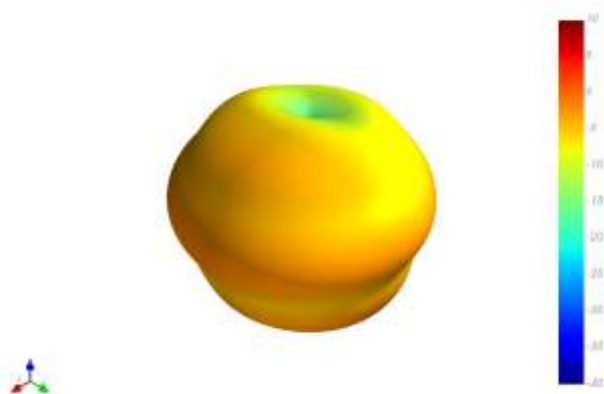

XY Plane

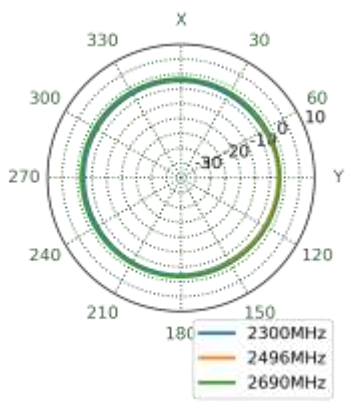

XZ Plane

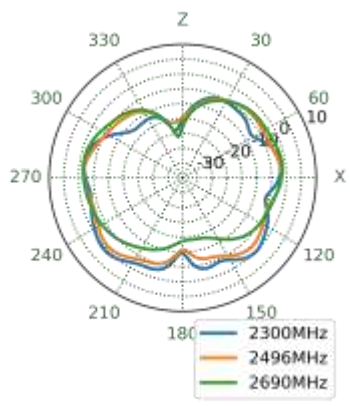

YZ Plane

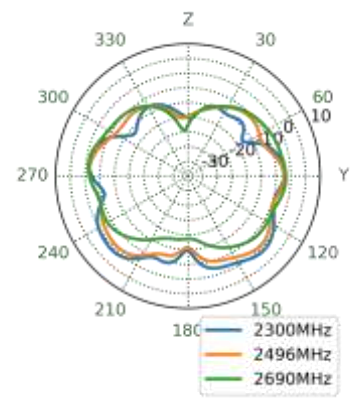

3550MHz

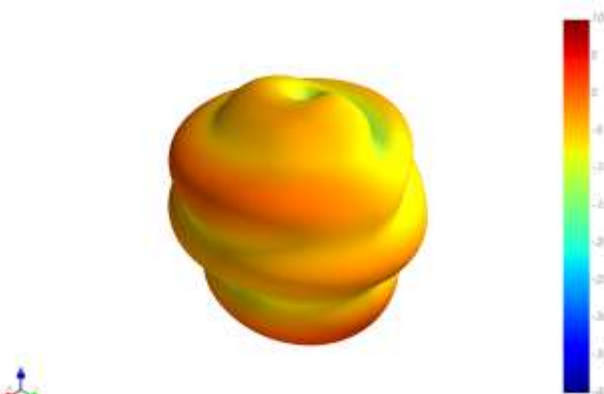

XY Plane

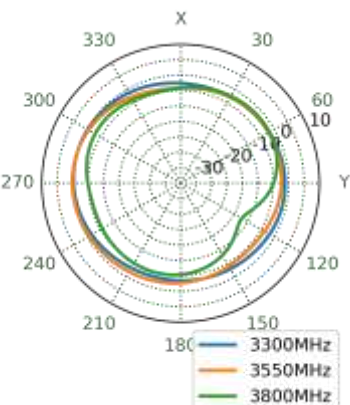

XZ Plane

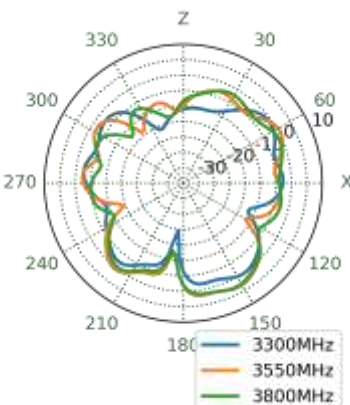

YZ Plane

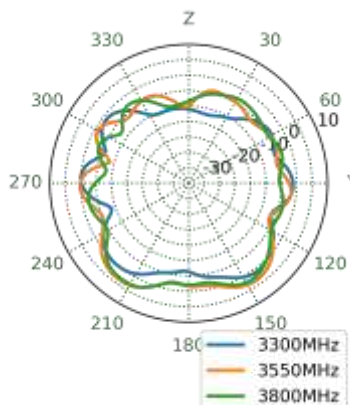

3700MHz

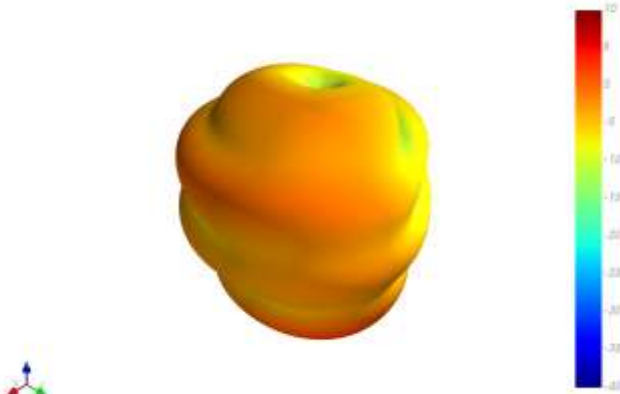

XY Plane

XZ Plane

YZ Plane

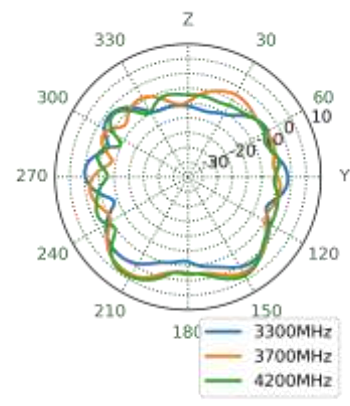
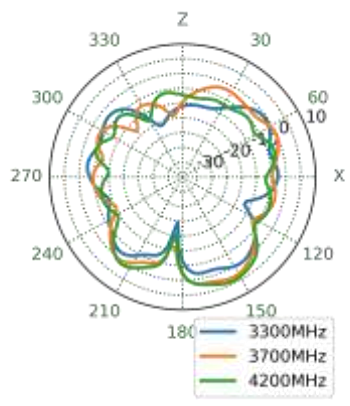
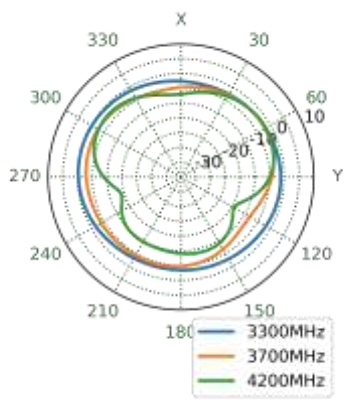

4800MHz

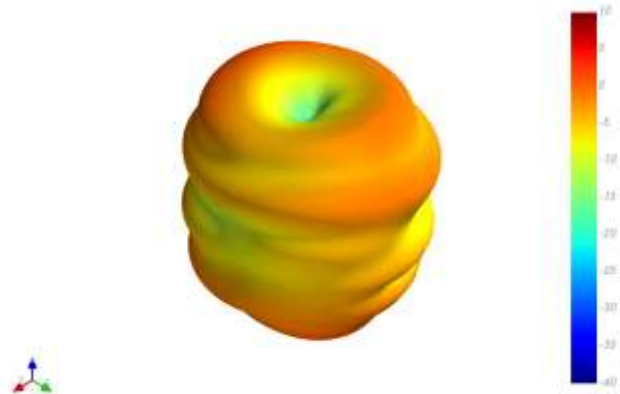

XY Plane

XZ Plane

YZ Plane

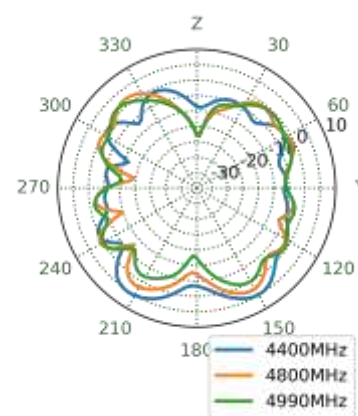
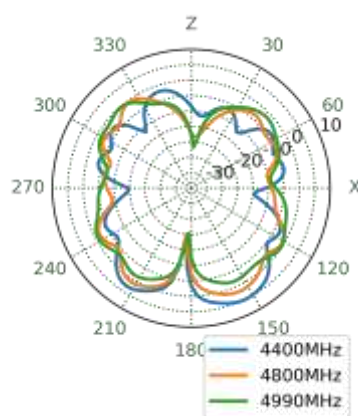
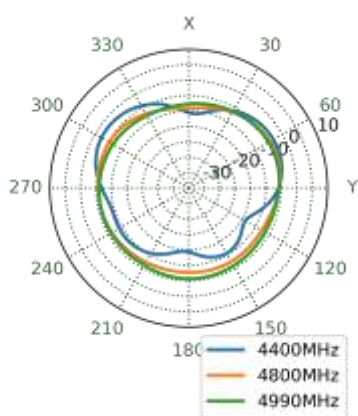

4.3 3D and 2D Radiation Patterns – Straight

663MHz

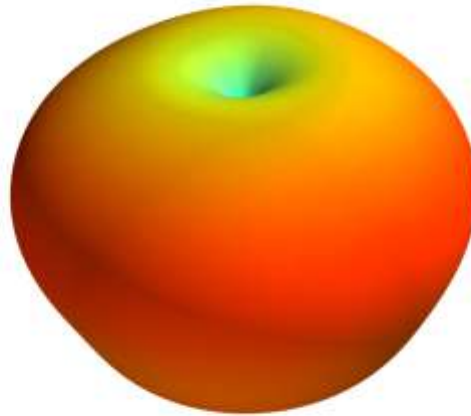

XY Plane

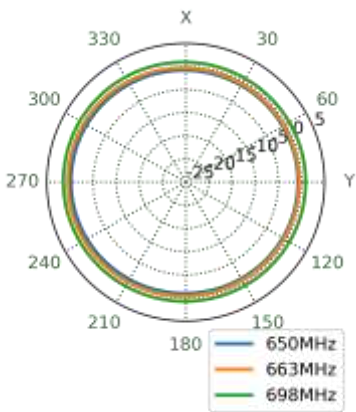

XZ Plane

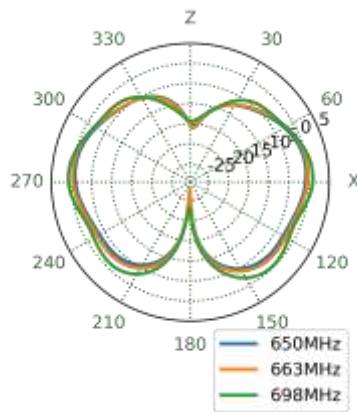

YZ Plane

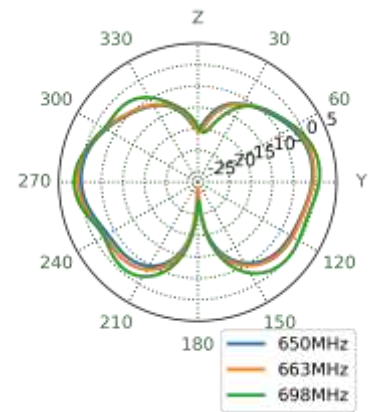

751MHz

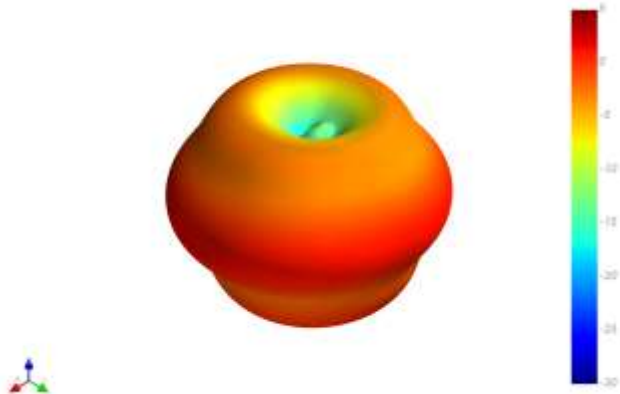

XY Plane

XZ Plane

YZ Plane

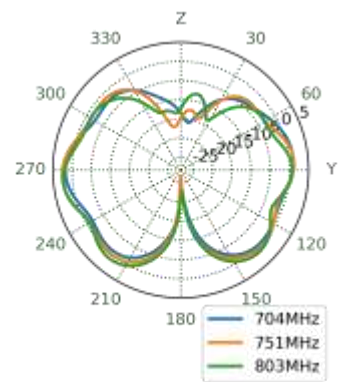
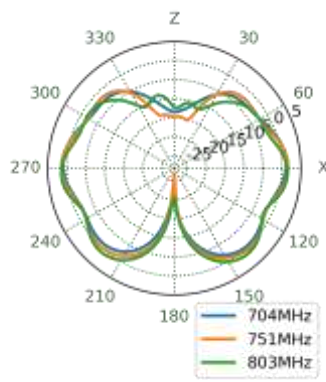
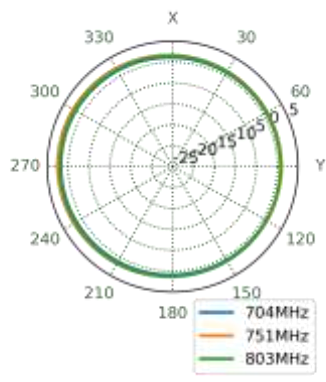

894MHz

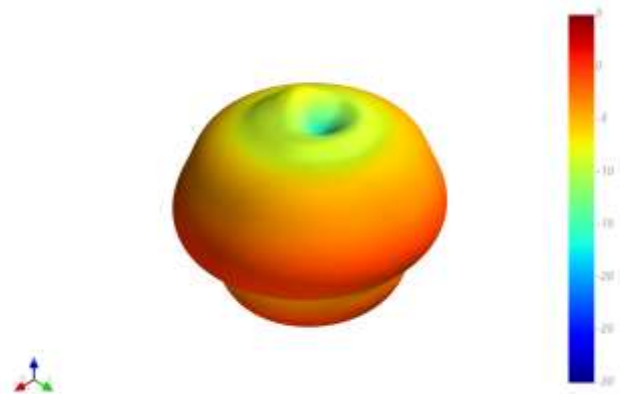

XY Plane

XZ Plane

YZ Plane

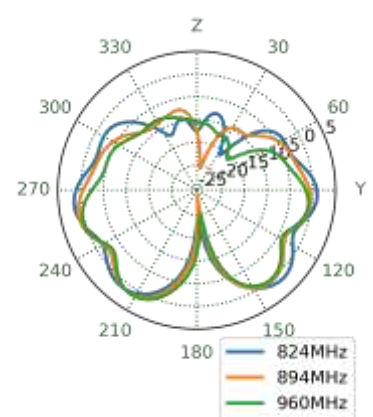
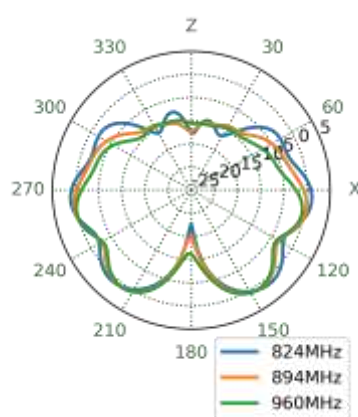
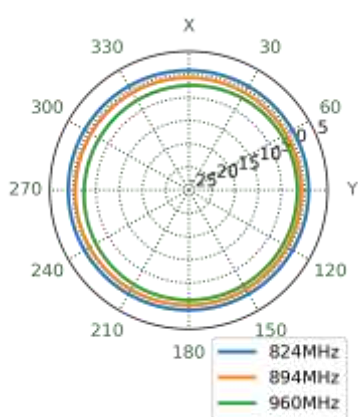

1470MHz

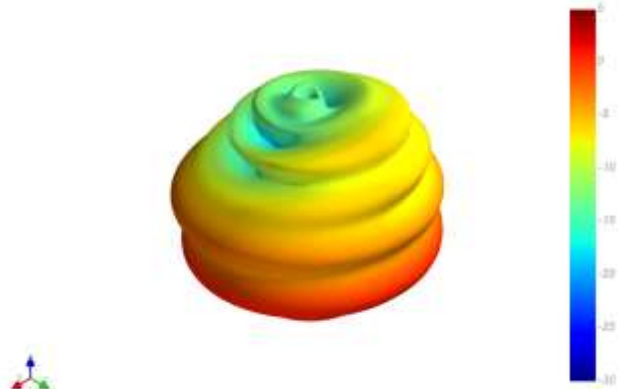

XY Plane

XZ Plane

YZ Plane

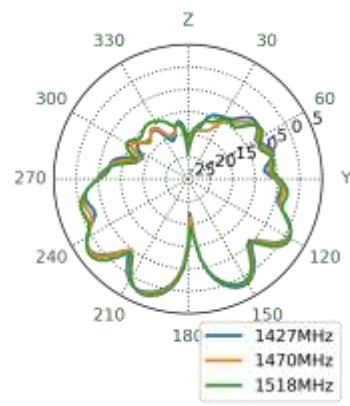
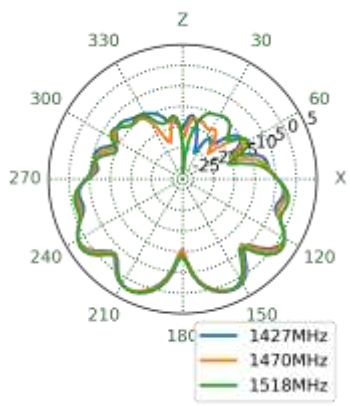
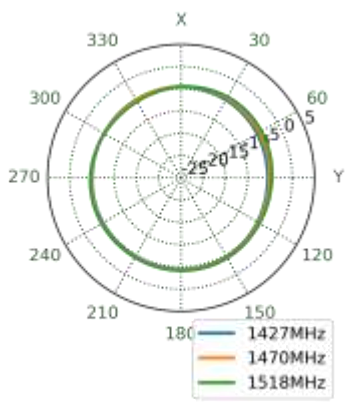

1850MHz

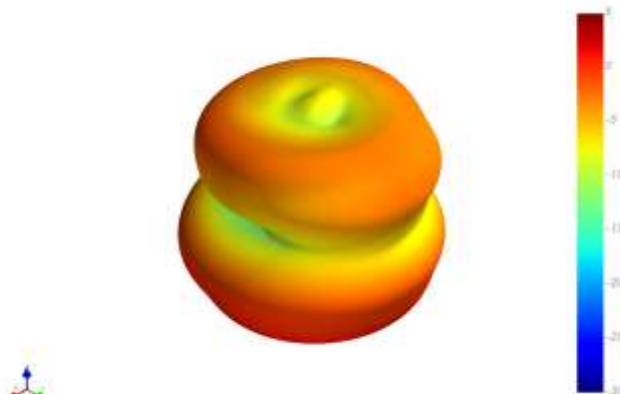

XY Plane

XZ Plane

YZ Plane

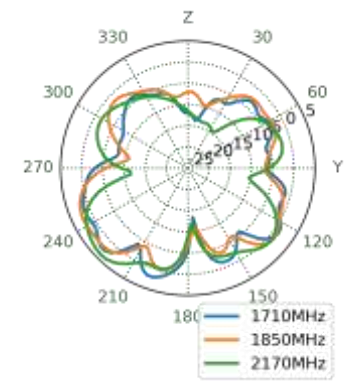
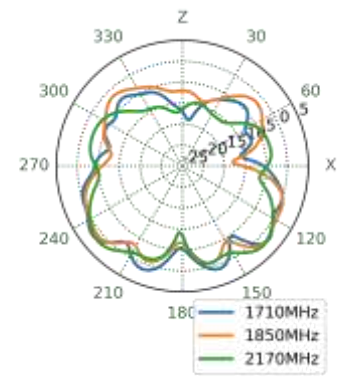
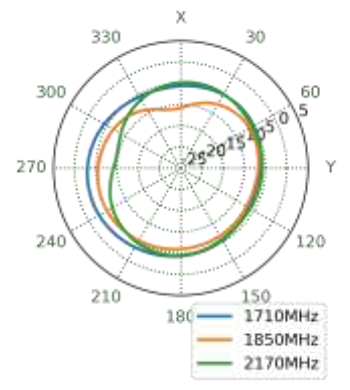

2496MHz

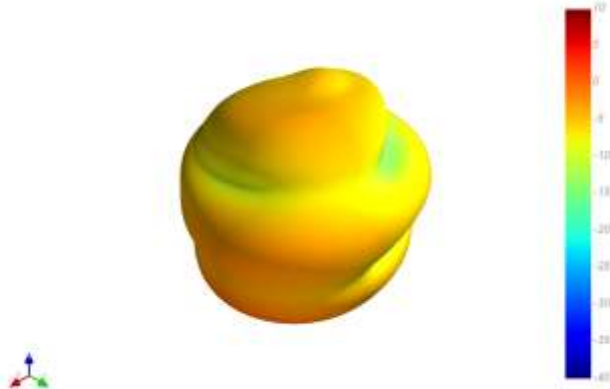

XY Plane

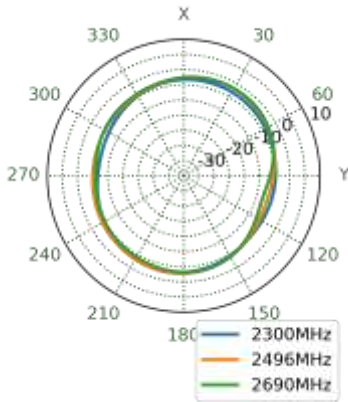

XZ Plane

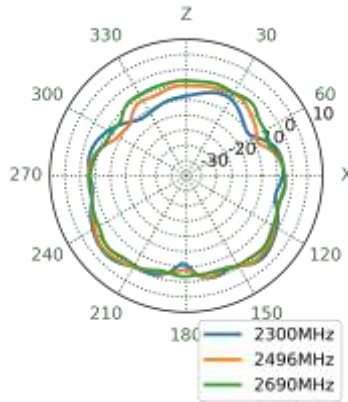

YZ Plane

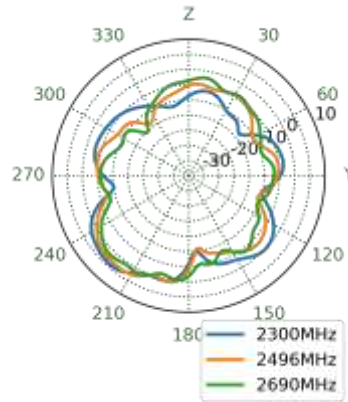

3550MHz

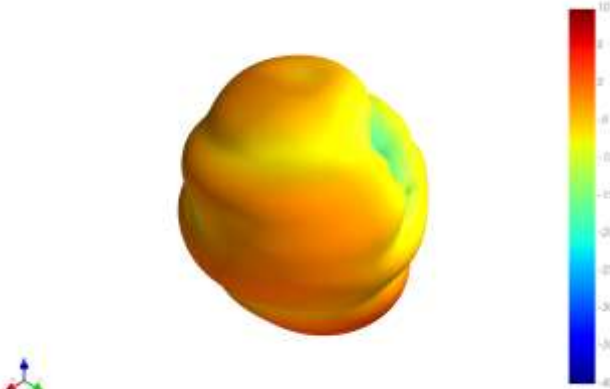

XY Plane

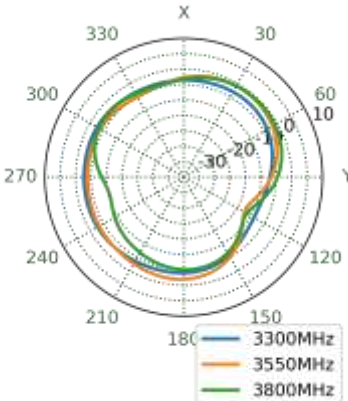

XZ Plane

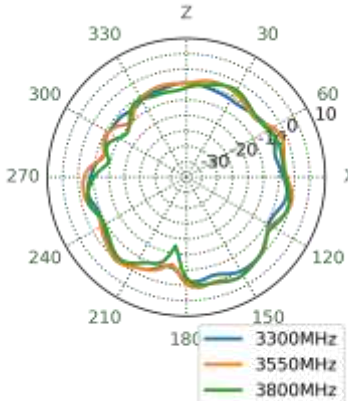

YZ Plane

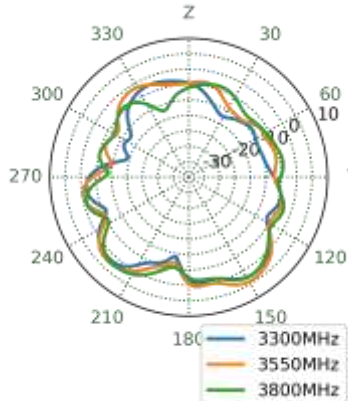

3700MHz

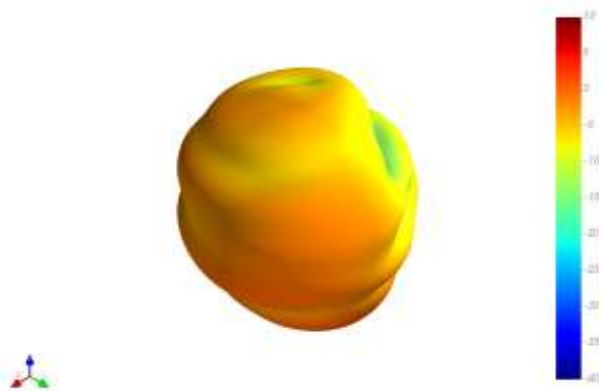

XY Plane

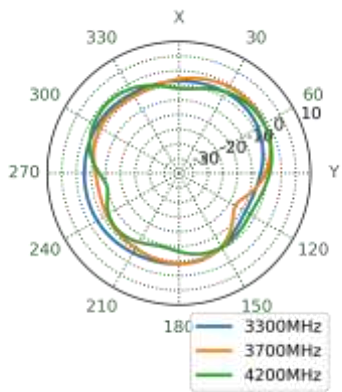

XZ Plane

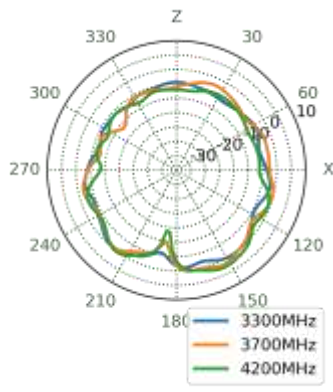

YZ Plane

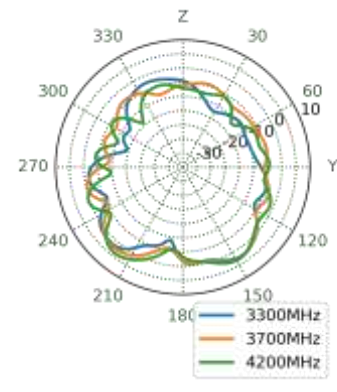

4800MHz

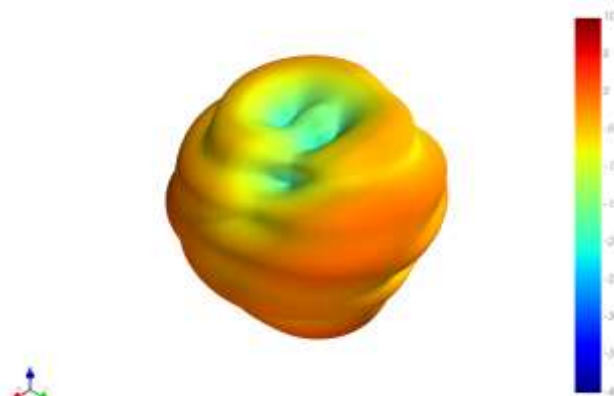

XY Plane

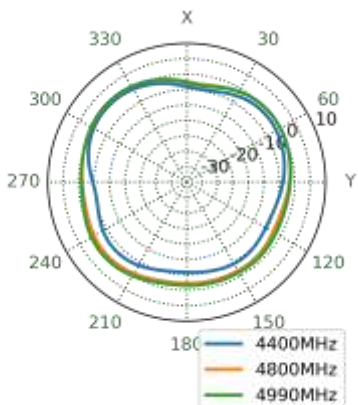

XZ Plane

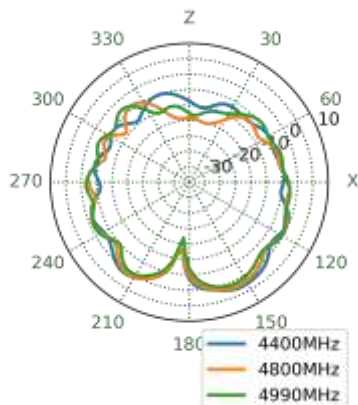

YZ Plane

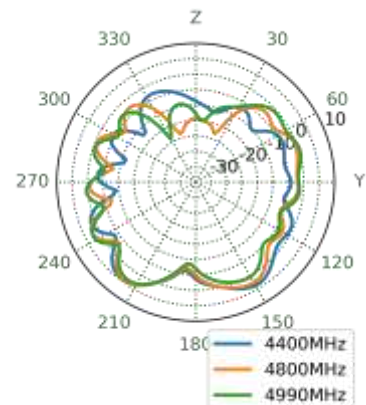

5. Mechanical Drawing (Units: mm)

ISO NO.: DW-21-8-0316

STATE: Release

NOTES: 1. All material must be RoHS compliant.
2. * Critical Dimensions.

REV	CDR	DESCRIPTION	ENG	APPROVED	DATE
D01	A1	Initial design	Aron Yan	Aaron	2021/3/5

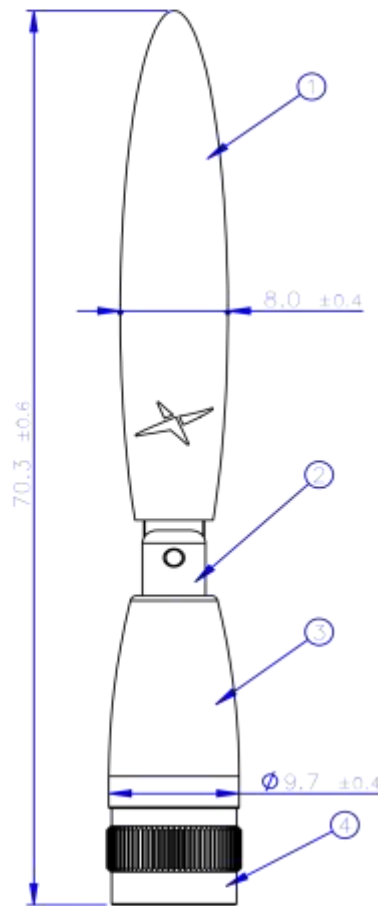
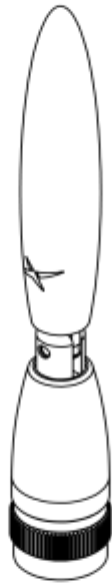

	Name	Material	Finish	QTY
1	TG.66 Top Housing	PC340(PC+ABS)	Black	1
2	TG.66 Hinge	NA	NA	1
3	TG.66 Bottom Housing	PC340(PC+ABS)	Black	1
4	TG.66 Copper joint housing	Brass	Ni Plated	1

APPROVED BY: Aaron	<p>TAOGLAS. TM Design Centre This drawing and its inherent design concepts are property of Taoglas. Not to be copied or given to third parties without the written consent of Taoglas.</p>			
CHECK BY: Aaron				
DRAWN BY: Aron Yan				
DATE: 2021/3/5				
UNLESS OTHERWISE SPECIFIED TOLERANCES ON:	TITLE: Wideband 600-6000MHz 5G/4G Connector Mount Monopole Antenna - Hinged SMA Male PART NO.: TG.66.A113			
THIRD ANGLE PROJECTION	UNIT: mm	SCALE: 2:1	PAGES: 1/1	REV: D01

6. Packaging

TG.66.A113

Packaging Specifications

1 pcs TG.66
per PE Bag
Weight - 9g

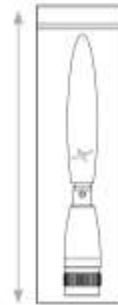

100 pcs TG.66
per Large PE Bag
Weight - 900g

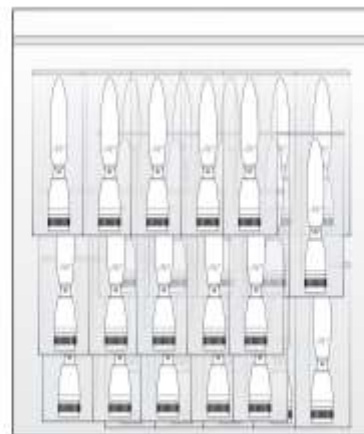

1500 pcs TG.66
per Carton
Dimensions - 360 x 310 x 160mm
Weight - 13.5Kg

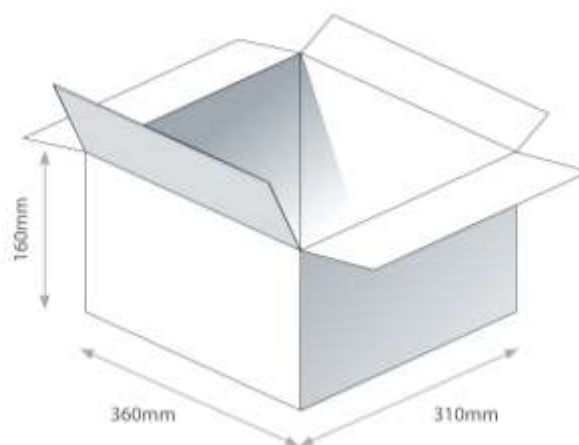

Changelog for the datasheet

SPE-21-8-047 – TG.66.A113

Revision: A (Original First Release)	
Date:	2021-07-07
Notes:	
Author:	Jack Conroy

Previous Revisions



www.taoglas.com

