

Click to
ORDER
samples

AMEOF350-HAMJZ

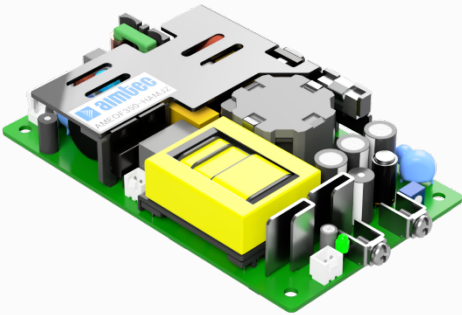

Open Frame/ Enclosed

AMEOF350-HAMJZ series is one of Aimtec's compact size (3"x5"x1") 350W AC/DC converter with active PFC and suitable for medical system equipment. It features universal AC input and at the same time accepts DC input voltage, cost-effective, high efficiency, high reliability and double or reinforced isolation. These converters offer excellent EMC and safety performance, which with UL62368-1, ES60601-1, EN62368-1 approval and meet IEC62368-1, GB4943.1, EN60335-1, IEC/EN61558-1, IEC/EN60601-1 standards and they are widely used in areas of industrial, LED, street light control, electricity, security, telecommunications, smart home, medical, etc.

Features

- Universal Input: 85 - 264VAC/120 - 370VDC
- Operating Temp: -40 °C to +70 °C
- High isolation voltage: 4000VAC
- Active PFC
- Output short circuit, over-current, over-voltage, over temperature protection
- Low no-load power consumption of 0.5W
- Suitable for Type BF application
- Certified : UL62368-1, ES60601-1
- Designed to meet IEC/EN62368-1, EN60335-1, EN61558-1, IEC/EN60601-1, GB4943.1



Summary

AMEOF350-HAMJZ

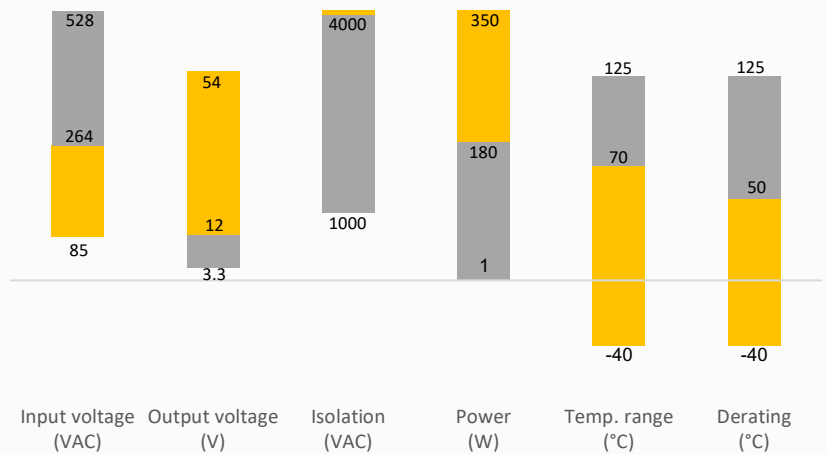

Training



Product Training Video
(click to open)

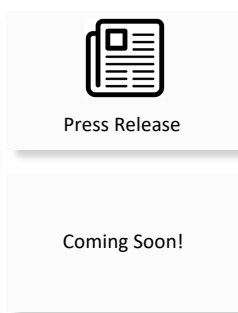

Application Notes

Applications



Power Grid



Industrial



Telecom



Medical

Models & Specifications

Single Output

Model	Input Voltage (VAC/Hz)	Input Voltage (VDC)	Cooling method	Max Output wattage (W)	Output Voltage (V)	Output Voltage Adjustable Range (V)	Output Current (A)	Maximum capacitive load (μF)	Efficiency @230VAC Typ. (%)
AMEOF350-12SHAMJZ	90-264/47-63	127-373	Free air	180	12	11.4-12.6	15	6000	92
			20.5CFM	300			25		
AMEOF350-15SHAMJZ	90-264/47-63	127-373	Free air	180	15	14.25-15.75	12	5000	92
			20.5CFM	325			21.67		
AMEOF350-24SHAMJZ	90-264/47-63	127-373	Free air	199.9	24	22.8-25.2	8.33	3200	93
			20.5CFM	350.4			14.6		
AMEOF350-27SHAMJZ	90-264/47-63	127-373	Free air	199.8	27	26.65-28.35	7.4	2600	93
			20.5CFM	351			13		
AMEOF350-36SHAMJZ	90-264/47-63	127-373	Free air	200.16	36	34.2-37.8	5.56	2000	93
			20.5CFM	350.28			9.73		
AMEOF350-48SHAMJZ	90-264/47-63	127-373	Free air	200.1	48	45.6-50.4	4.17	2000	94
			20.5CFM	350.4			7.3		
AMEOF350-54SHAMJZ #0	90-264/47-63	127-373	Free air	199.8	54	51.3-56.7	3.7	2000	94
			20.5CFM	351			6.5		

Add suffix -F for enclosed package. (ex. AMEOF350-12SHAMJZ-F is enclosed package version)

Input Specifications

Parameters	Conditions	Typical	Maximum	Units
Input current	115VAC		4	A
	230VAC		2	A
Inrush current	115VAC, cold start	50		A
	230VAC, cold start	75		A
Leakage	240VAC, normal condition		0.1	mA
	240VAC, single fault condition		0.5	mA
Power factor	115VAC, 100% load	≥0.98		
	230VAC, 100% load	≥0.95		

Output Specifications

Parameters	Conditions	Typical	Maximum	Units
Voltage accuracy	12, 15V	±3		%
	24, 27, 36, 48, 54V	±2		%
Line regulation	Full load	±0.5		%
Load regulation	0-100% load	±1		%
Ripple & Noise*	12, 15V, 10-100% load		120	mV p-p
	24V, 10-100% load		150	mV p-p
	27, 36V, 10-100% load		200	mV p-p
	48, 54V, 10-100% load		250	mV p-p
	12, 15V, 0-10% load		180	mV p-p
	24V, 0-10% load		225	mV p-p
	27, 36V, 0-10% load		300	mV p-p
48, 54V, 0-10% load		375	mV p-p	

Hold up time	230VAC, Free air convection	14		ms
	230VAC, 20.5CFM	8		ms

* Ripple and Noise are measured at 20MHz bandwidth with a 10 μ F electrolytic capacitor and a 0.1 μ F ceramic capacitor. Please refer to the application note for specific details.

Isolation Specification				
Parameters	Conditions	Typical	Maximum	Units
Tested I/O voltage	60 sec, leakage \leq 10mA	\geq 4000		VAC
Tested I/PE voltage	60 sec, leakage \leq 10mA	\geq 2000		VAC
Tested O/PE voltage	60 sec, leakage \leq 10mA	\geq 1500		VAC
Resistance I/O*	500VDC	$>$ 100		M Ω
Resistance I/PE*	500VDC	$>$ 100		M Ω
Resistance O/PE*	500VDC	$>$ 100		M Ω
MOP I/O			2xMOPP	
MOP I/PE			1xMOPP	
MOP O/PE			1xMOPP	

* Tested under 25 \pm 5 $^{\circ}$ C ambient temperature with relative humidity $<$ 95% and no condensation.

General Specifications				
Parameters	Conditions	Typical	Maximum	Units
Protection class	Class II without protective earth connection, Class I with protective earth connection			
Over current protection	Auto recovery, hiccup	\geq 110		% of Iout
Over voltage protection	12Vout, shut down, manual recovery		15	VDC
	15Vout, shut down, manual recovery		18.5	VDC
	24Vout, shut down, manual recovery		30	VDC
	27Vout, shut down, manual recovery		33.5	VDC
	36Vout, shut down, manual recovery		45	VDC
	48Vout, shut down, manual recovery		59.5	VDC
	54Vout, shut down, manual recovery		63	VDC
Short circuit protection	Hiccup, Continuous, Auto recovery time $<$ 3S			
Over temperature protection	Shut down, manual recovery			
Fan power	27V	12V/0.5A, Voltage accuracy \pm 15/-25%		
No-load power consumption	12, 15, 24, 36, 48, 54V	12V/0.5A, Voltage accuracy \pm 15%		
Operating temperature	See derating graph	-40 to +70		$^{\circ}$ C
Storage temperature		-40 to +85		$^{\circ}$ C
Power Derating	+50 $^{\circ}$ C to +70 $^{\circ}$ C	2.5		%/ $^{\circ}$ C
Ambient temperature derating	90VAC to 100VAC	1		%/VAC
Temperature coefficient	Operating altitude $>$ 2000m	5		$^{\circ}$ C/1000m
Cooling		\pm 0.03		%/ $^{\circ}$ C
Humidity	Free air convection, forced air convection 20.5CFM			
	Non-condensing, storage	$>$ 10	95	% RH
	Non-condensing, operating	$>$ 20	90	% RH
Case material	Enclosed package	Metal (1100 Aluminum, SUS304)		
Weight	Open frame	295		g
	Enclosed	430		g
Dimensions (L x W x H)	Open frame	5.00 x 3.00 x 1.00 inches (127.0 x 76.2 x 25.4 mm)		
	Enclosed	5.12 x 3.39 x 1.38 inches (130.0 x 86.0 x 35.0 mm)		
MTBF	$>$ 300 000 hrs (MIL-HDBK -217F, t= \pm 25 $^{\circ}$ C)			

NOTE: All specifications in this datasheet are measured at an ambient temperature of 25 $^{\circ}$ C, humidity $<$ 75%, nominal input voltage and at rated output load unless otherwise specified.

Safety Specifications

Parameters

Agency approvals: cULus: UL 62368-1(# With exception of 54Vout model); ANSI/AAMI ES60601-1 V3.1(Ø With exception of 54Vout model); CAN/CSA-C22.2 No.60601-1:14 Ed3(Ø With exception of 54Vout model)
CE: EN62368-1

Design to meet IEC/EN62368-1, EN60335-1, IEC/EN61558-1, IEC/EN60601-1, EN60601-1-2 Ed4, GB4943.1

Standards

EMC - Conducted and radiated emission*	CISPR32 / EN55032, conducted class B CISPR32 / EN55032, radiated class B with protective earth connection CISPR32 / EN55032, radiated class A without protective earth connection
EMC - Harmonic current emissions*	IEC 61000-3-2 class A and class D
EMC - Voltage fluctuations and flicker *	IEC 61000-3-3
Electrostatic Discharge Immunity *	IEC 61000-4-2 Contact ±8KV, Air ±15KV, Criteria A
RF, Electromagnetic Field Immunity *	IEC 61000-4-3 10V/m, Criteria A
Electrical Fast Transient/Burst Immunity *	IEC 61000-4-4 ±4KV, Criteria A
Surge Immunity *	IEC 61000-4-5 L-L ±2KV L-G ±4KV, Criteria A
RF, Conducted Disturbance Immunity *	IEC 61000-4-6 10Vr.m.s, Criteria A
Voltage dips, Short Interruptions Immunity *	IEC 61000-4-11 0%, 70%, Criteria B

* The power supply is considered as a component and will be installed in an end-product. All the EMC tests are performed with the power supply mounted on a 1mm thick 360mm x 360mm metal plate. The EMC compliance of the end-product must be reconfirmed.

Derating

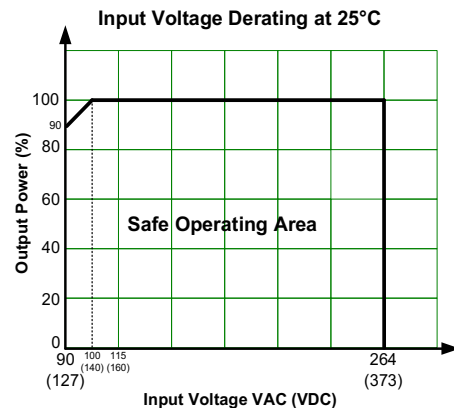
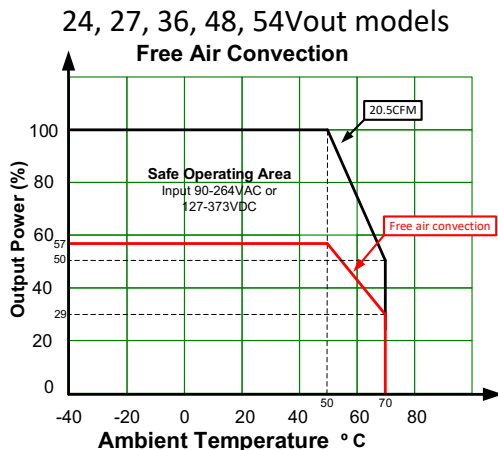
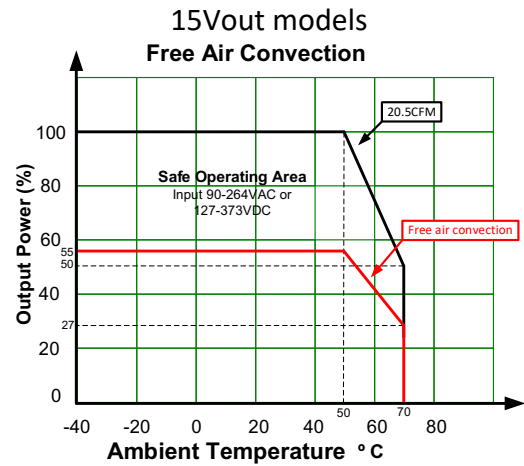
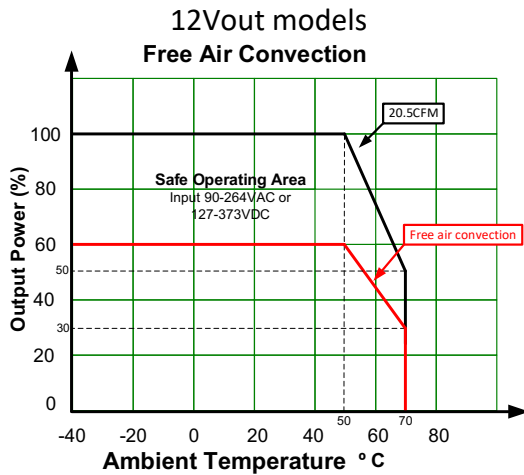

Dimensions

Open frame model

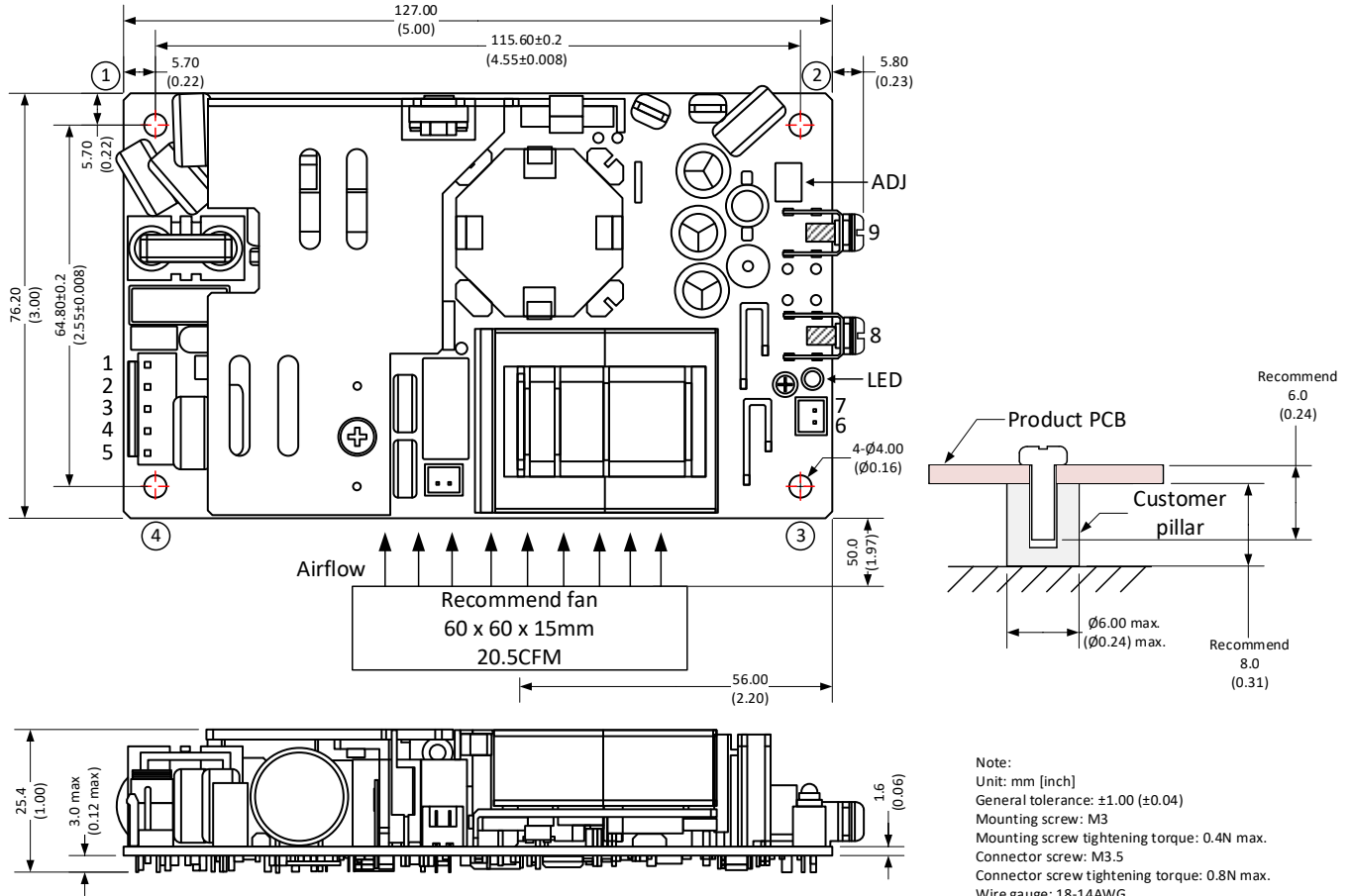

Note:

1. It is needed to have $\geq 10\text{mm}$ distance between the product and external components for safety.
2. Connect mounting point 1, 2 and 4 to protective earth for Class I system.
3. Connect mounting point 1, 2 and 4 together for Class II system.

Pin Output Specifications

Pin	Function	Connector	Recommended connector
1	AC Input (N)	JST B5P-VH or equivalent	JST VHR, JST SVH-21PT-P1.1 or equivalent
2	NC		
3	AC Input (L)		
4	NC		
5	Earth \perp		
6	- Fan Output	2.5 XHS-2A or equivalent	2.5 XHS-2Y or equivalent
7	+ Fan Output		
8	-V Output		
9	+V Output		

Enclosed model

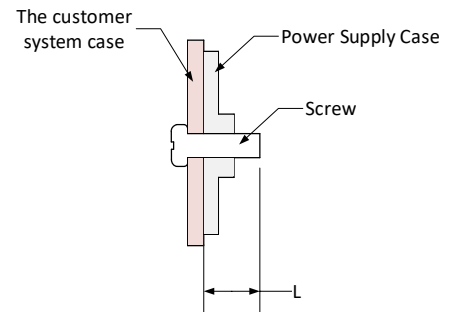
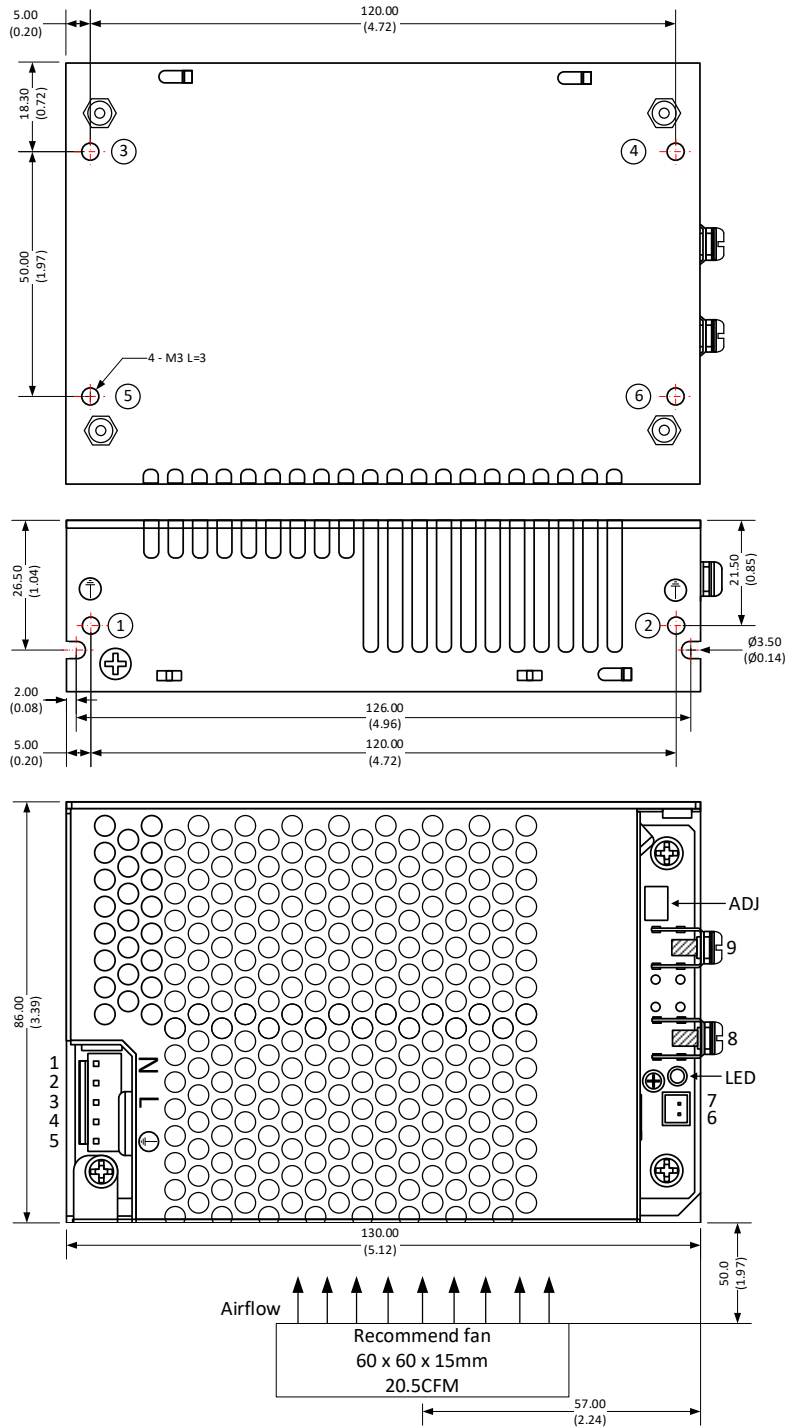

Note:
Unit: mm [inch]
General tolerance: ± 1.00 (± 0.04)
Mounting screw: M3
Mounting screw tightening torque: 0.4N max.
Connector screw: M3.5
Connector screw tightening torque: 0.8N max.
Wire gauge: 18-14AWG
Case must be connected to PE

NOTE: 1. Datasheets are updated as needed and as such, specifications are subject to change without notice. Once printed or downloaded, datasheets are no longer controlled by Aimtec; refer to www.aimtec.com for the most current product specifications. 2. Product labels shown, including safety agency certifications on labels, may vary based on the date manufactured. 3. Mechanical drawings and specifications are for reference only. 4. All specifications are measured at an ambient temperature of 25°C, humidity < 75%, nominal input voltage and at rated output load unless otherwise specified. 5. Aimtec may not have conducted destructive testing or chemical analysis on all internal components and chemicals at the time of publishing this document. CAS numbers and other limited information are considered proprietary and may not be available for release. 6. This product is not designed for use in critical life support systems, equipment used in hazardous environments, nuclear control systems or other such applications which necessitate specific safety and regulatory standards other than the ones listed in this datasheet. 7. Warranty is in accordance with Aimtec's standard Terms of Sale available at www.aimtec.com.