

## Dimensions: [mm]

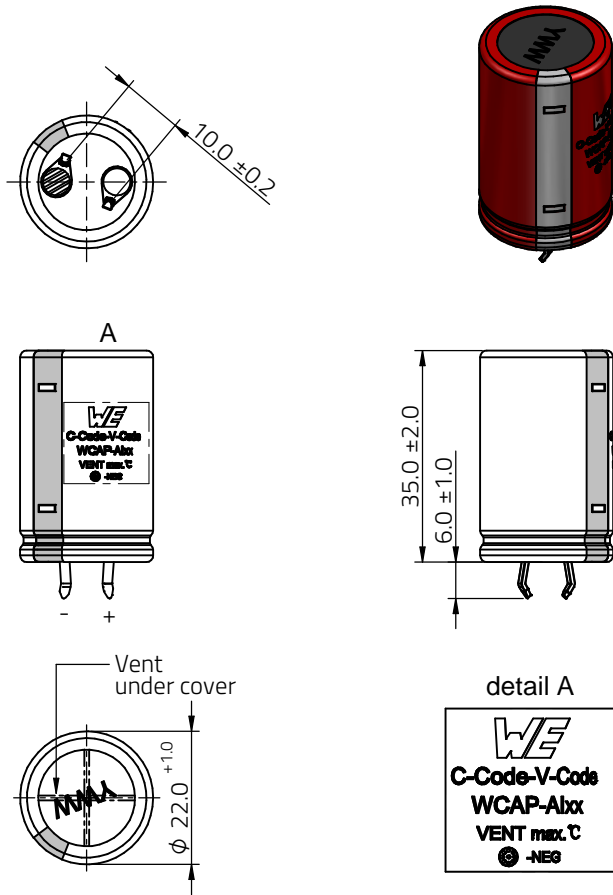

## Recommended Hole Pattern: [mm]

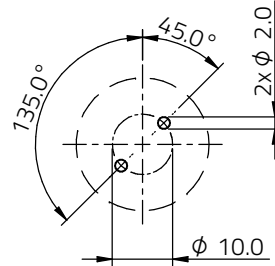

## Schematic:

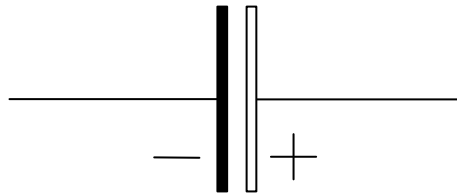

## Electrical Properties:

| Properties         |              | Test conditions                         | Value | Unit          | Tol.       |
|--------------------|--------------|---|-------|---------------|------------|
| Capacitance        | C            | 0.25 V/ 120 Hz/ +20 °C                  | 2200  | $\mu\text{F}$ | $\pm 20\%$ |
| Rated Voltage      | $V_R$        |   | 63    | V (DC)        | max.       |
| Surge Voltage      | $V_S$        | 1000 cycles @ 105 °C                    | 72.4  | V (DC)        | max.       |
| Leakage Current    | $I_{Leak}$   | $V_r / 5 \text{ min.} / +20 \text{ °C}$ | 1117  | $\mu\text{A}$ | max.       |
| Dissipation Factor | DF           | 0.25 V/ 120 Hz/ +20 °C                  | 20    | %             | max.       |
| Ripple Current     | $I_{RIPPLE}$ | 120 Hz @ 105 °C                         | 1830  | mA            | max.       |
| ESR                | $R_{ESR}$    | 0.25 V/ 120 Hz/ +20 °C                  | 120   | m $\Omega$    | max.       |

## General Information:

| Aluminum Electrolytic Capacitors   |   |
|--|---|
| Operating Temperature  | -40 °C up to +105 °C                      |
| Storage Conditions (in original packaging)   | 5 °C up to + 35 °C; 10 % rH up to 75 % rH |
| Endurance  | 3000 h                                    |
| Moisture Sensitivity Level (MSL)   | 1   |
| Test conditions of electrical properties: +20 °C, 35 % rH if not specified differently |   |
| FIT according to separate documentation  |   |
| Surge Voltage: charging time 30 s, discharging time 330 s for a cycle                  |   |



Würth Elektronik eiSos GmbH & Co. KG  
EMC & Inductive Solutions  
Max-Eyth-Str. 1  
74638 Waldenburg  
Germany  
Tel. +49 (0) 79 42 945 - 0  
www.we-online.com  
eiSos@we-online.com





| CHECKED   | REVISION | DATE (YYYY-MM-DD) | GENERAL TOLERANCE       | PROJECTION METHOD |
|---|----------|-------------------|-------------------------|-------------------|
| FPu   | 002.000  | 2026-04-27        | DIN ISO 2768-1m         |                   |
| DESCRIPTION                                       |          |                   | TECHNICAL REFERENCE     |                   |
| <b>WCAP-AI3H Aluminum Electrolytic Capacitors</b> |          |                   | ANDN350222M063DSIC3C000 |                   |
|   |          |                   | ORDER CODE              |                   |
|   |          |                   | <b>861140783006</b>     |                   |
| SIZE/TYPE   |          | BUSINESS UNIT     | STATUS                  | PAGE              |
| 22.0 x 35.0                                       |          | eiCap             | Valid                   | 1/10              |

## Instruction for optional fixation:

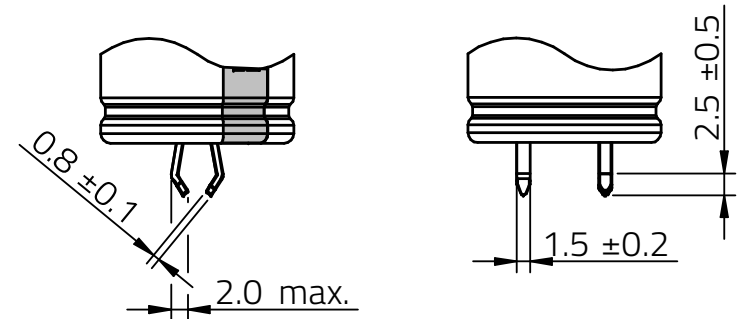

## Detail View:

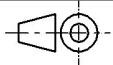

|  |   |                        |                                 |                                      |  |
|--|---|------------------------|---------------------------------|--------------------------------------|--|
|    | CHECKED<br>FPu  | REVISION<br>002.000    | DATE (YYYY-MM-DD)<br>2026-04-27 | GENERAL TOLERANCE<br>DIN ISO 2768-1m | PROJECTION METHOD<br> |
|  | DESCRIPTION<br><b>WCAP-AI3H Aluminum Electrolytic Capacitors</b>  |                        |                                 |                                      | TECHNICAL REFERENCE<br>ANDN350222M063DSIC3C000   |
|  <b>WURTH ELEKTRONIK</b><br>MORE THAN YOU EXPECT  | Würth Elektronik eiSos GmbH & Co. KG<br>EMC & Inductive Solutions<br>Max-Eyth-Str. 1<br>74638 Waldenburg<br>Germany<br>Tel. +49 (0) 79 42 945 - 0<br>www.we-online.com<br>eiSos@we-online.com |                        |                                 | ORDER CODE<br><b>861140783006</b>    |  |
|  | SIZE/TYPE<br>22.0 x 35.0  | BUSINESS UNIT<br>eiCap | STATUS<br>Valid                 | PAGE<br>2/10                         |  |

## Component Marking:

|                      |   |
|----------------------|---|
| 1 <sup>st</sup> Line | Capacitance Value: 2200 µF & Rated Voltage: 63 V (DC) |
| 2 <sup>nd</sup> Line | WCAP-AI3H   |
| 3 <sup>rd</sup> Line | VENT + max. Operating Temperature + 105 °C            |
| 4 <sup>th</sup> Line | Negative pin marking                                  |

## Multiplier for Ripple Current vs. Frequency

| Voltage [V <sub>R</sub> ]/ Frequency [Hz] | 50 (60) | 120  | 300  | 1K   | 10K  | 50K-100K |
|---|---------|------|------|------|------|----------|
| 10 ≤ V <sub>R</sub> ≤ 100                 | 0.88    | 1.00 | 1.07 | 1.15 | 1.15 | 1.15     |
| 160 ≤ V <sub>R</sub> ≤ 250                | 0.81    | 1.00 | 1.17 | 1.32 | 1.45 | 1.5      |
| 315 ≤ V <sub>R</sub> ≤ 600                | 0.77    | 1.00 | 1.16 | 1.30 | 1.41 | 1.43     |

## Lifetime Performance:

| Test Conditions | Useful life                            | Endurance                              | Shelf Life   |
|-----------------|--|--|--|
| Lifetime        | 5000 h @ 105 °C                        | 3000 h @ 105 °C                        | 1000 h @ 105 °C  |
| Voltage         | V <sub>R</sub> applied                 | V <sub>R</sub> applied                 | None   |
| Current         | I <sub>R</sub>                         | I <sub>R</sub>                         | None   |
| Δ C             | ≤ ±30 % of initial measured value      | ≤ ±20 % of initial measured value      | ≤ ±20 % of initial measured value  |
| DF              | ≤ 300 % of the initial specified value | ≤ 200 % of the initial specified value | ≤ 200 % of the initial specified value   |
| Leakage Current | ≤ the initial specified value          | ≤ the initial specified value          | ≤ the initial specified value  |
| Failure Rate    | ≤0.01 %/ 1000 h                        |  |  |
| Comment         |  |  | Before measurement: Restore capacitor to 20 °C, apply for V <sub>R</sub> applied for 30 min. |



## Multiplier for Ripple Current vs. Temperature:

| Temperature [°C] | 45  | 65   | 85   | 105 |
|------------------|-----|------|------|-----|
| Multiplier       | 2.1 | 1.78 | 1.40 | 1   |

This is only for calculation. Changes of other conditions will influence the lifetime. The lifetime calculation has to consider the application specific parameters which are applied to the capacitor. (e.g. ambient temperature, ripple current)

## Certification:

|                |                                     |
|----------------|-------------------------------------|
| RoHS Approval  | Compliant [2011/65/EU&2015/863]     |
| REACH Approval | Conform or declared [(EC)1907/2006] |
| Halogen Free   | Conform [JEDEC JS709B]              |
| Halogen Free   | Conform [IEC 61249-2-21]            |

|   |  |                |                     |  |   |  |
|---|--|----------------|---------------------|--|---|--|
|   |  | CHECKED<br>FPu | REVISION<br>002.000 | DATE (YYYY-MM-DD)<br>2026-04-27                | GENERAL TOLERANCE<br>DIN ISO 2768-1m  | PROJECTION METHOD<br> |
|  <b>WÜRTH ELEKTRONIK</b><br>MORE THAN YOU EXPECT |  |                |                     |  | Würth Elektronik eiSos GmbH & Co. KG<br>EMC & Inductive Solutions<br>Max-Eyth-Str. 1<br>74638 Waldenburg<br>Germany<br>Tel. +49 (0) 79 42 945 - 0<br>www.we-online.com<br>eiSos@we-online.com |  |
| DESCRIPTION<br><b>WCAP-AI3H Aluminum Electrolytic Capacitors</b>  |  |                |                     | TECHNICAL REFERENCE<br>ANDN350222M063DSIC3C000 |   |  |
| ORDER CODE<br><b>861140783006</b>   |  |                |                     | SIZE/TYPE<br>22.0 x 35.0                       | BUSINESS UNIT<br>eiCap  | STATUS<br>Valid  |
|   |  |                |                     | PAGE<br>3/10                                   |   |  |

## Packaging Specification - Tray: [mm]

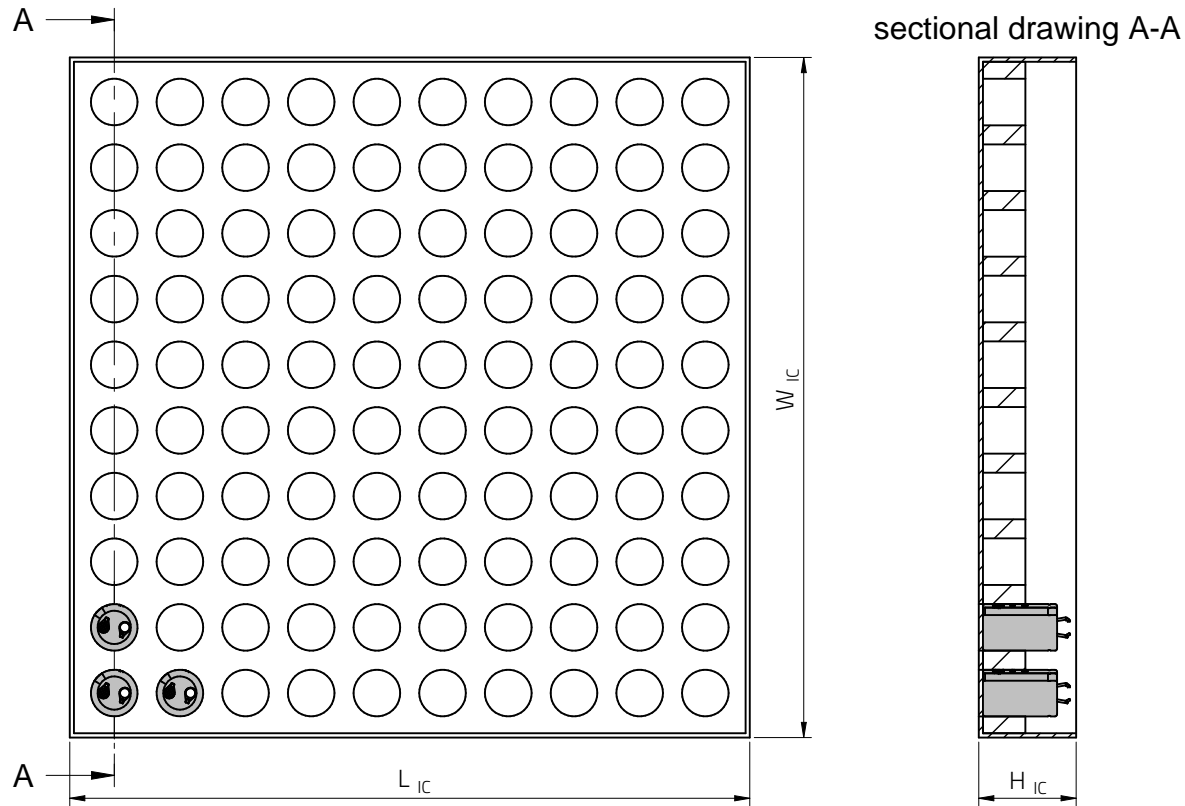

|                  | L <sub>IC</sub> (mm) | W <sub>IC</sub> (mm) | H <sub>IC</sub> (mm) | Packaging Unit | Material |
|------------------|----------------------|----------------------|----------------------|----------------|----------|
| <b>Tolerance</b> | typ.                 | typ.                 | typ.                 | pcs.           |          |
| <b>Value</b>     | 325,00               | 325,00               | 64,00                | 100            | Paper    |

## Packaging Specification - Outer Carton: [mm]

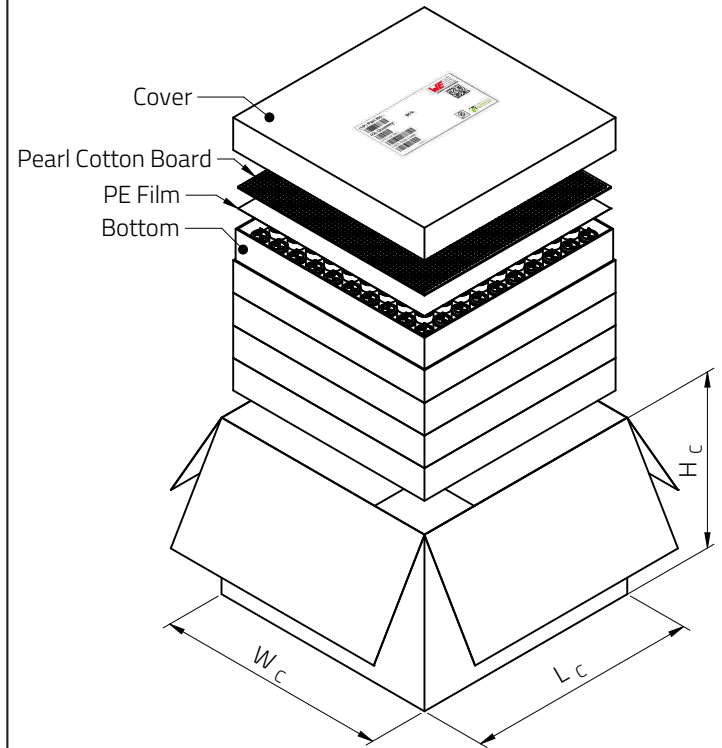

|                  | L <sub>C</sub> (mm) | W <sub>C</sub> (mm) | H <sub>C</sub> (mm) | No. of inner carton | Packaging Unit | Material |
|------------------|---------------------|---------------------|---------------------|---------------------|----------------|----------|
| <b>Tolerance</b> | typ.                | typ.                | typ.                | pcs.                | pcs.           |          |
| <b>Value</b>     | 345,00              | 345,00              | 340,00              | 5                   | 500            | Paper    |



Würth Elektronik eiSos GmbH & Co. KG  
 EMC & Inductive Solutions  
 Max-Eyth-Str. 1  
 74638 Waldenburg  
 Germany  
 Tel. +49 (0) 79 42 945 - 0  
 www.we-online.com  
 eiSos@we-online.com

| CHECKED   | REVISION      | DATE (YYYY-MM-DD) | GENERAL TOLERANCE       | PROJECTION METHOD |
|---|---------------|-------------------|-------------------------|-------------------|
| FPu   | 002.000       | 2026-04-27        | DIN ISO 2768-1m         |                   |
| DESCRIPTION                                       |               |                   | TECHNICAL REFERENCE     |                   |
| <b>WCAP-AI3H Aluminum Electrolytic Capacitors</b> |               |                   | ANDN350222M063DSIC3C000 |                   |
| ORDER CODE  |               |                   | <b>861140783006</b>     |                   |
| SIZE/TYPE   | BUSINESS UNIT | STATUS            | PAGE                    |                   |
| 22.0 x 35.0                                       | eiCap         | Valid             | 4/10                    |                   |

## Classification Wave Soldering Profile:



## Classification Wave Soldering Profile:

| Profile Feature   |                         | Pb-Free Assembly                            | Sn-Pb Assembly                              |
|---|-------------------------|---|---|
| Preheat Temperature Min   | $T_{s \min}$            | 100 °C                                      | 100 °C                                      |
| Preheat Temperature Typical   | $T_{s \text{ typical}}$ | 120 °C                                      | 120 °C                                      |
| Preheat Temperature Max   | $T_{s \max}$            | 130 °C                                      | 130 °C                                      |
| Preheat Time $t_s$ from $T_{s \min}$ to $T_{s \max}$                    | $t_s$                   | 70 seconds                                  | 70 seconds                                  |
| Ramp-up Rate $\Delta$ Temperature from $T_{s \text{ typical}}$ to $T_p$ | $\Delta T$              | 150 °C max.                                 | 150 °C max.                                 |
| Peak Temperature  | $T_p$                   | 250 °C - 260 °C                             | 235 °C - 260 °C                             |
| Time of actual peak temperature   | $t_p$                   | max. 10 seconds<br>max. 5 seconds each wave | max. 10 seconds<br>max. 5 seconds each wave |
| Ramp-down Rate, Min   |                         | ~ 2 K/ second                               | ~ 2 K/ second                               |
| Ramp-down Rate, Typical   |                         | ~ 3.5 K/ second                             | ~ 3.5 K/ second                             |
| Ramp-down Rate, Max   |                         | ~ 5 K/ second                               | ~ 5 K/ second                               |
| Time 25 °C to 25 °C   |                         | 4 minutes                                   | 4 minutes                                   |

refer to EN61760-1:2006



Würth Elektronik eiSos GmbH & Co. KG  
 EMC & Inductive Solutions  
 Max-Eyth-Str. 1  
 74638 Waldenburg  
 Germany  
 Tel. +49 (0) 79 42 945 - 0  
 www.we-online.com  
 eiSos@we-online.com

| CHECKED   | REVISION      | DATE (YYYY-MM-DD) | GENERAL TOLERANCE       | PROJECTION METHOD |
|---|---------------|-------------------|-------------------------|-------------------|
| FPu   | 002.000       | 2026-04-27        | DIN ISO 2768-1m         |                   |
| DESCRIPTION                                       |               |                   | TECHNICAL REFERENCE     |                   |
| <b>WCAP-AI3H Aluminum Electrolytic Capacitors</b> |               |                   | ANDN350222M063DSIC3C000 |                   |
|   |               |                   | ORDER CODE              |                   |
|   |               |                   | <b>861140783006</b>     |                   |
| SIZE/TYPE   | BUSINESS UNIT | STATUS            | PAGE                    |                   |
| 22.0 x 35.0                                       | eiCap         | Valid             | 5/10                    |                   |

## Further information

### Component Libraries:

|             |   |
|-------------|---|
| Altium      | <a href="#">Altium_WCAP-AI3H (26a)</a>            |
| Cadence17-2 | <a href="#">Downloads_CADENCE_WCAP-AI3H (26a)</a> |
| Cadstar     | <a href="#">Cadstar_WCAP-AI3H (21a)</a>           |
| Eagle       | <a href="#">Eagle_WCAP-AI3H (26a)</a>             |
| IGS         | <a href="#">IGS_WCAP-AI3H_22x35</a>               |
| KiCad       | <a href="#">KiCad_WCAP-AI3H (26b)</a>             |
| PSPice      | <a href="#">PSPice_WCAP-AI3H (26a)</a>            |
| STP         | <a href="#">Download_STP_86114xx8300x</a>         |

### Free Sample Order:





[Order free samples of this article directly here!](#)

### Tutorials:

- [Capacitor Portfolio Flyer \(PDF\)](#)
- [Expected Lifetime Calculation of Aluminium Capacitors \(PDF\)](#)
- [All Capacitors are "Audio Capacitors" \(PDF\)](#)
- [More about Aluminum Electrolytic Capacitors](#)

### REDEXPERT:

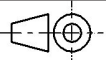
[Determine characteristics for 861140783006 with REDEXPERT](#)

|   |   |   |   |                        |  |                                      |   |
|---|---|---|---|------------------------|--|--------------------------------------|---|
| <br>ROHS<br>COMPLIANT  | <br>REACH<br>COMPLIANT | <br>HALOGEN<br>FREE | CHECKED<br>FPu  | REVISION<br>002.000    | DATE (YYYY-MM-DD)<br>2026-04-27                | GENERAL TOLERANCE<br>DIN ISO 2768-1m | PROJECTION<br>METHOD<br> |
|   |   |   | DESCRIPTION<br><b>WCAP-AI3H Aluminum Electrolytic<br/>Capacitors</b>  |                        | TECHNICAL REFERENCE<br>ANDN350222M063DSIC3C000 |                                      |   |
| <br><b>WÜRTH<br/>ELEKTRONIK<br/>MORE THAN<br/>YOU EXPECT</b> |   |   | Würth Elektronik eiSos GmbH & Co. KG<br>EMC & Inductive Solutions<br>Max-Eyth-Str. 1<br>74638 Waldenburg<br>Germany<br>Tel. +49 (0) 79 42 945 - 0<br>www.we-online.com<br>eiSos@we-online.com |                        |  | ORDER CODE<br><b>861140783006</b>    |   |
|   |   |   | SIZE/TYPE<br>22.0 x 35.0  | BUSINESS UNIT<br>eiCap | STATUS<br>Valid                                | PAGE<br>6/10                         |   |

## Cautions and Warnings:

### The following conditions apply to all goods within the product series of Aluminum Electrolytic Snap-In Capacitors of Würth Elektronik eiSos GmbH & Co. KG:

#### General:

- This electronic component is designed and manufactured for use in general electronic equipment.
- Würth Elektronik must be asked for a written approval (following the certain PPAP level procedure) before incorporating the components into any equipment in the field such as military, aerospace, aviation, nuclear control, submarine, transportation (automotive control, train control, ship control), transportation signal, disaster prevention, medical, public information network etc. where higher safety and reliability are especially required and/or if there is the possibility of direct damage or human injury.
- Electronic components that will be used in safety-critical or high-reliability applications should be pre-evaluated by the customer.
- Direct mechanical impact to the product shall be prevented as material of the body, pins or termination could flake or in the worst case it could break.
- Avoid any water or heavy dust on capacitors surface, which may cause electrical leakage, damage, overheating or corrosion.
- Würth Elektronik products are qualified according to international standards, which are listed in each product reliability report. Würth Elektronik does not warrant any customer qualified product characteristic, beyond Würth Elektronik specifications, for its validity and sustainability over time.
- The customer is responsible for the functionality of his or her own products. All technical specifications for standard products also apply to customer specific products.
- The component is designed and manufactured to be used within the datasheet specified values. If the usage and operation conditions specified in the datasheet are not met, the body, pins or termination may be damaged or dissolved.
- Do not apply any kind of flexural or compressive force onto soldered or unsoldered component.
- The capacitance tolerance as specified within the datasheet is only valid on the date of delivery and according specified measurement criteria.

#### Product specific:

#### Storage conditions:

- A storage of Würth Elektronik products for longer than 12 months is not recommended. Within other effects, the terminals may suffer degradation, resulting in bad solderability. Therefore, all products shall be used within the period of 12 months based on the day of shipment.
- Do not expose the components into direct sunlight.
- The storage conditions in the original packaging are defined according to DIN EN 61760-2.
- The environment in which the capacitors are operated and stored has to have atmospheric characteristics and must be free of dew condensation and toxic gases (e.g. chlorine, ammonia, sulfur, hydrogen sulphide and hydrogen sulfate).
- Do not expose the capacitor to environments with hazardous gas, ozone, ultraviolet rays or any kind of radiation. Avoid any contact of the capacitor with direct sunshine, saltwater, spray of water or types of oil during storage.

- If a capacitor is stored for a long time without applying voltage or storage conditions of 35 °C or above and more than 75 % relative humidity, the leakage current may increase.
- The leakage current will return to normal level when applying the rated voltage to the capacitor before use. If the capacitor was stored for a long period of time, it is recommended to apply DC working voltage to the capacitor for 30 minutes through a 1 kΩ protective series resistor.
- The storage conditions stated in the original packaging apply to the storage time and not to the transportation time of the components.

#### Packaging:

- The packaging specifications apply only to purchase orders comprising whole packaging units. If the ordered quantity exceeds or is lower than the specified packaging unit, packaging in accordance with the packaging specifications cannot be ensured.

#### Polarity:

- An aluminum electrolytic capacitor has a polarity. In operation, this polarity needs to be considered and adhered. Reverse voltage can damage or destroy an aluminum electrolytic capacitor. This can finally lead to a malfunction of the product or even the end of the application.
- If the polarity in a circuit will be switched or can possibly be reversed, the usage of a non-polar capacitor shall be applied. The polarity of an aluminum electrolytic capacitor is for Snap-In types marked as follows: a minus sign on one of the claw fasteners indicates the negative terminal. On the sleeve, the negative terminal is marked with a color band and thereon are minus signs given.

#### Overvoltage:



- Avoid any overvoltage and do not apply a continuous overvoltage. If an overvoltage is applied to the capacitor, the leakage current can increase drastically. This can shorten the lifetime. In a worst case, this could lead to a short circuit failure mode.
- The applied working voltage is not allowed to exceed the rated voltage of the specific capacitor.

#### Operating temperature:

- The capacitor shall not be operated outside the operating temperature range, which is stated in the datasheet of the specific capacitor.
- The achievable lifetime of the capacitor is correlating to the applied temperature. In order to achieve the maximum lifetime, the capacitor should be operated at the lowest possible temperature conditions within the application.

#### Ripple current:

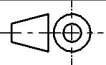
- The applied ripple current shall not exceed the specified maximum ripple current of the capacitor.
- If a higher ripple current as permitted is applied, it can cause excessive heat generation and higher temperature inside the capacitor. This happens due to pole change effects. This can result in damage or lifetime shortage of the capacitor and may cause deterioration.
- Please see electrical specification within this datasheet for maximum allowed ripple current.

|   |  |  |                |                        |                                 |  |  |  |
|---|--|--|----------------|------------------------|---------------------------------|--|--|--|
|   |  |  | CHECKED<br>FPU | REVISION<br>002.000    | DATE (YYYY-MM-DD)<br>2026-04-27 | GENERAL TOLERANCE<br>DIN ISO 2768-1m                             | PROJECTION METHOD<br> |  |
|  <b>WÜRTH ELEKTRONIK</b><br><b>MORE THAN YOU EXPECT</b>  |  |  |                |                        |                                 | DESCRIPTION<br><b>WCAP-AI3H Aluminum Electrolytic Capacitors</b> |  | TECHNICAL REFERENCE<br>ANDN350222M063DSIC3C000 |
|   |  |  |                |                        |                                 | ORDER CODE<br><b>861140783006</b>                                |  |  |
| SIZE/TYPE<br>22.0 x 35.0  |  |  |                | BUSINESS UNIT<br>eiCap |                                 | STATUS<br>Valid  | PAGE<br>7/10   |  |
| Würth Elektronik eiSos GmbH & Co. KG<br>EMC & Inductive Solutions<br>Max-Eyth-Str. 1<br>74638 Waldenburg<br>Germany<br>Tel. +49 (0) 79 42 945 - 0<br>www.we-online.com<br>eiSos@we-online.com |  |  |                |                        |                                 |  |  |  |

## Charge and discharge:

- Frequent and quick charge / discharge cycles may generate heat inside the capacitor. In worst case, this can cause a decrease of capacitance, an increase of leakage current or breakdown.
- Applications with rapid charge and discharge cycles should be avoided. For assistance with your application, please consult our technical support.

## Vent:

- On most aluminum electrolytic capacitor types, a predetermined breaking point is given on the top of the component, which is the so-called vent. The vent is there to assure a possible pressure relief and to avoid that the capacitor can explode due to internal pressure, which can occur by applying reverse voltage or a too high ripple current.
- A space of at least 3 mm above the vent is recommended, in order to assure the full function of the vent. If less space is present, the vent may not operate correctly / completely.

## Sleeve:

- The sleeve material consists of PET (polyethylene terephthalate). If excessive heat is applied to the sleeve (e.g. soldering process, etc.), the sleeve may crack or deform. If the capacitor will be exposed to xylene, toluene or likewise and will be afterwards heated, the sleeve may crack or deform.
- The sleeve does not assure any electrical insulation. It is to avoid using / placing the product on a spot where electrical insulation is needed. To assure electrical insulation, especially to the case of capacitor, further actions need to be taken.

## Soldering:

- The solder profile must comply with the technical product specifications. All other profiles will void the warranty.
- All other soldering methods are at the customer's own risk.
- Strong forces which may affect the coplanarity of the component's electrical connection with the PCB (i.e. pins), can damage the part, resulting in void of the warranty.
- Customer needs to ensure that the applied solder paste, the paste thickness and solder conditions are enough to guarantee a sufficient solder result according to the relevant criteria of IPC-A-610.
- Excessive amount of solder may lead to higher tensile force and chip cracking. Insufficient amount of solder may detach the capacitor due to defective contacts.
- Do not use excessive nor insufficient flux.
- Provide enough washing when water-soluble flux is used.
- During wave soldering only the pins / terminals should have contact with hot solder bath / wave. No direct contact of capacitor body with hot solder bath / wave or with any other component must be assured. Soldering must be done from the opposite PCB side to where the capacitor body is placed.

## Cleaning and washing:

Do not wash the assembled capacitors with the following cleaning agents:

- Petroleum system solvents: may cause degeneration of the rubber seal material.
- Alkali system solvents: may cause corrosion and dissolve of the aluminum case.
- Halogenated solvents: may cause corrosion and failure of the capacitor.
- Acetone: component marking may be erased.
- Xylene: may cause deterioration of the rubber seal material.

Verify the following points when washing is applied to capacitors:

- Please monitor conductivity, pH-value, specific gravity and the water content of cleaning agents. Contamination adversely affects the performance of the capacitor.
- Be sure to not expose the capacitors under solvent rich conditions or keep capacitors inside a closed container. In addition, please dry the solvents on the PCB and the capacitor sufficiently with an air knife (temperature should be less than the maximum rated category temperature of the capacitor) for 10 minutes.
- Capacitors can be characteristically and catastrophically damaged by halogen ions, particularly by chlorine ions. The degree of the damage mainly depends upon the characteristics of the electrolyte and rubber seal material. When halogen ions come into contact with the inside of the capacitors, the foil may corrode, when a voltage is applied. This corrosion causes an extremely high leakage current, which results in venting and an open circuit defect.



All other cleaning processes and cleaning agents are not approved by Würth Elektronik. All cleaning methods need to be tested and validated by the customer.

## Adhesives and coating materials:

The usage of any adhesive or coating material, which contains halogenated solvents, is not allowed. In general, all adhesives as well as filling and coating materials need to be tested and validated by the customer.

Before applying adhesives or coating materials, make sure that the following points are fulfilled:

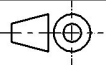
- Take care that the surface and capacitor is dry and clean before applying adhesive or coating, to avoid any contamination with flux residues or cleaning solvents.
- Assure that no flux residue or spot is left between the rubber seal material of the capacitor and the PCB.
- Do not fully cover the entire rubber seal surface with adhesive, coating or molding materials. Otherwise, the covering of the full rubber seal surface may restrain the natural diffusion of hydrogen gas. Block maximum 80% of the sealed section of a capacitor.
- If the used adhesive, coating or molding material contains halogen ions in a large amount, the halogen ions can diffuse and creep into the capacitor and can damage the capacitor. Both above explained circumstances can result in serious failures.
- Follow the specified heating and curing instructions given by supplier of the used adhesive or coating material. Avoid excessive pressure or heat on the capacitor by applying coating or adhesive.

|   |   |                        |                                 |                                      |  |
|---|---|------------------------|---------------------------------|--------------------------------------|--|
|   | CHECKED<br>FPu  | REVISION<br>002.000    | DATE (YYYY-MM-DD)<br>2026-04-27 | GENERAL TOLERANCE<br>DIN ISO 2768-1m | PROJECTION METHOD<br> |
|   | DESCRIPTION<br><b>WCAP-AI3H Aluminum Electrolytic Capacitors</b>  |                        |                                 |                                      | TECHNICAL REFERENCE<br>ANDN350222M063DSIC3C000   |
|  <b>WÜRTH ELEKTRONIK</b><br>MORE THAN YOU EXPECT | Würth Elektronik eiSos GmbH & Co. KG<br>EMC & Inductive Solutions<br>Max-Eyth-Str. 1<br>74638 Waldenburg<br>Germany<br>Tel. +49 (0) 79 42 945 - 0<br>www.we-online.com<br>eiSos@we-online.com |                        |                                 | ORDER CODE<br><b>861140783006</b>    |  |
|   | SIZE/TYPE<br>22.0 x 35.0  | BUSINESS UNIT<br>eiCap | STATUS<br>Valid                 | PAGE<br>8/10                         |  |

- The used materials of gluing, coating or filling can possibly react with the marking of the component. This can change the optical appearance.
- Take care that hardening of adhesive, coating material was correctly done, so that no solvents do remain.
- Be aware, that used solvents within adhesive and coating materials can damage the sleeve of the capacitor and can result in changes of the appearance of the sleeve (color, shine and marking).

### Operation and usage of the capacitor:

In operation and usage, take care about the following points. Do not use the capacitor within the following environmental conditions:

- Environment with high mechanical stress / shocks or vibration (please see this specific datasheet for permitted limits).
- Environment with high amount of damp condensation, water or types of oil.
- Direct sunlight, ozone, any kind of radiation or ultraviolet rays.
- Toxic gases (e.g. ammonium, chlorine and compounds, bromine and compounds, hydrogen sulfide, sulfuric acid).

User should never touch the terminals of the capacitor directly. Avoid short circuit between terminals with any kind of conductive material (e.g. metal, fluid, acid, alkaline solution).

### Maintenance:

For industrial applications, it is recommended to perform periodic inspections. Power supplies shall be turned off before inspection to discharge the capacitor. Check the following points in case of an inspection:

- Visual inspection of the capacitor to see, if the vent operated for pressure relief and if any leakage of electrolyte has taken place.
- Measurement of electrical characteristics of the capacitor (according to datasheet, especially leakage current, capacitance and dissipation factor).

In case of deviation or failure according to the specified characteristics, take care to start appropriate actions (e.g. replacement of capacitor).



### Emergency case:

- In case of excessive pressure within the capacitor, the vent may operate and release this pressure. In case of vent operation, gas becomes visible when the component is in operation. If so, directly turn off the application and disconnect it from the power source. If the application is not turned off, a possible short circuit of capacitor or a short circuit due to bridging of liquefied gas can possibly damage the circuit and, in worst case, the application may be dramatically damaged.
- Do not stay or position body or face above or in direction of the vent, because in the event of any vent operation, the releasing gas temperature may have over 100 °C.
- In case the electrolyte gets in contact with skin, wash the skin immediately with plenty of soap and water. If the released gas gets in contact with eyes, rinse immediately with plenty of water and seek medical advice. In case the gas was inhaled, gargle immediately with plenty of water and seek medical advice.

### Disposal:

- Please contact your local responsible or organization for proper disposal of capacitor. In addition, take care to be compliant with your local governmental law and restrictions.
- In case of incineration, it should be done with more than 800 °C. Lower temperatures of incineration can result in toxic gases (e.g. chlorine). To avoid any explosion of capacitor, punch holes into the can or crush the capacitor before incineration.

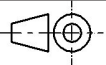
These cautions and warnings comply with the state of the scientific and technical knowledge and are believed to be accurate and reliable. However, no responsibility is assumed for inaccuracies or incompleteness. V2.0.

|   |   |                        |                                 |                                      |  |
|---|---|------------------------|---------------------------------|--------------------------------------|--|
|   | CHECKED<br>FPu  | REVISION<br>002.000    | DATE (YYYY-MM-DD)<br>2026-04-27 | GENERAL TOLERANCE<br>DIN ISO 2768-1m | PROJECTION METHOD<br> |
|   | DESCRIPTION<br><b>WCAP-AI3H Aluminum Electrolytic Capacitors</b>  |                        |                                 |                                      | TECHNICAL REFERENCE<br>ANDN350222M063DSIC3C000   |
|  <b>WÜRTH ELEKTRONIK</b><br>MORE THAN YOU EXPECT | Würth Elektronik eiSos GmbH & Co. KG<br>EMC & Inductive Solutions<br>Max-Eyth-Str. 1<br>74638 Waldenburg<br>Germany<br>Tel. +49 (0) 79 42 945 - 0<br>www.we-online.com<br>eiSos@we-online.com |                        |                                 | ORDER CODE<br><b>861140783006</b>    |  |
|   | SIZE/TYPE<br>22.0 x 35.0  | BUSINESS UNIT<br>eiCap | STATUS<br>Valid                 | PAGE<br>9/10                         |  |

## Important Notes

The following conditions apply to all goods within the product range of Würth Elektronik eiSos GmbH & Co. KG:

### 1. General Customer Responsibility

Some goods within the product range of Würth Elektronik eiSos GmbH & Co. KG contain statements regarding general suitability for certain application areas. These statements about suitability are based on our knowledge and experience of typical requirements concerning the areas, serve as general guidance and cannot be estimated as binding statements about the suitability for a customer application. The responsibility for the applicability and use in a particular customer design is always solely within the authority of the customer. Due to this fact it is up to the customer to evaluate, where appropriate to investigate and decide whether the device with the specific product characteristics described in the product specification is valid and suitable for the respective customer application or not.

### 2. Customer Responsibility related to Specific, in particular Safety-Relevant Applications

It has to be clearly pointed out that the possibility of a malfunction of electronic components or failure before the end of the usual lifetime cannot be completely eliminated in the current state of the art, even if the products are operated within the range of the specifications. In certain customer applications requiring a very high level of safety and especially in customer applications in which the malfunction or failure of an electronic component could endanger human life or health it must be ensured by most advanced technological aid of suitable design of the customer application that no injury or damage is caused to third parties in the event of malfunction or failure of an electronic component. Therefore, customer is cautioned to verify that data sheets are current before placing orders. The current data sheets can be downloaded at [www.we-online.com](http://www.we-online.com).

### 3. Best Care and Attention

Any product-specific notes, cautions and warnings must be strictly observed. Any disregard will result in the loss of warranty.

### 4. Customer Support for Product Specifications

Some products within the product range may contain substances which are subject to restrictions in certain jurisdictions in order to serve specific technical requirements. Necessary information is available on request. In this case the field sales engineer or the internal sales person in charge should be contacted who will be happy to support in this matter.

### 5. Product R&D

Due to constant product improvement product specifications may change from time to time. As a standard reporting procedure of the Product Change Notification (PCN) according to the JEDEC-Standard inform about minor and major changes. In case of further queries regarding the PCN, the field sales engineer or the internal sales person in charge should be contacted. The basic responsibility of the customer as per Section 1 and 2 remains unaffected.

### 6. Product Life Cycle



Due to technical progress and economical evaluation we also reserve the right to discontinue production and delivery of products. As a standard reporting procedure of the Product Termination Notification (PTN) according to the JEDEC-Standard we will inform at an early stage about inevitable product discontinuance. According to this we cannot guarantee that all products within our product range will always be available. Therefore it needs to be verified with the field sales engineer or the internal sales person in charge about the current product availability expectancy before or when the product for application design-in disposal is considered. The approach named above does not apply in the case of individual agreements deviating from the foregoing for customer-specific products.

### 7. Property Rights

All the rights for contractual products produced by Würth Elektronik eiSos GmbH & Co. KG on the basis of ideas, development contracts as well as models or templates that are subject to copyright, patent or commercial protection supplied to the customer will remain with Würth Elektronik eiSos GmbH & Co. KG. Würth Elektronik eiSos GmbH & Co. KG does not warrant or represent that any license, either expressed or implied, is granted under any patent right, copyright, mask work right, or other intellectual property right relating to any combination, application, or process in which Würth Elektronik eiSos GmbH & Co. KG components or services are used.

### 8. General Terms and Conditions

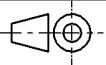
Unless otherwise agreed in individual contracts, all orders are subject to the current version of the "General Terms and Conditions of Würth Elektronik eiSos Group", last version available at [www.we-online.com](http://www.we-online.com).

|   |  |  |                |                        |                                 |  |  |  |
|---|--|--|----------------|------------------------|---------------------------------|--|--|--|
|   |  |  | CHECKED<br>FPu | REVISION<br>002.000    | DATE (YYYY-MM-DD)<br>2026-04-27 | GENERAL TOLERANCE<br>DIN ISO 2768-1m                             | PROJECTION METHOD<br> |  |
|  <b>WÜRTH ELEKTRONIK</b><br><b>MORE THAN YOU EXPECT</b>  |  |  |                |                        |                                 | DESCRIPTION<br><b>WCAP-AI3H Aluminum Electrolytic Capacitors</b> |  | TECHNICAL REFERENCE<br>ANDN350222M063DSIC3C000 |
|   |  |  |                |                        |                                 | ORDER CODE<br><b>861140783006</b>                                |  |  |
| SIZE/TYPE<br>22.0 x 35.0  |  |  |                | BUSINESS UNIT<br>eiCap |                                 | STATUS<br>Valid  | PAGE<br>10/10  |  |
| Würth Elektronik eiSos GmbH & Co. KG<br>EMC & Inductive Solutions<br>Max-Eyth-Str. 1<br>74638 Waldenburg<br>Germany<br>Tel. +49 (0) 79 42 945 - 0<br><a href="http://www.we-online.com">www.we-online.com</a><br><a href="mailto:eiSos@we-online.com">eiSos@we-online.com</a> |  |  |                |                        |                                 |  |  |  |