

RFELA-2/58X

863-870MHz – 5.8dBi Fiberglass Omnidirectional High Gain Outdoor Antenna for LoRa, LoRaWAN / LongFi and ISM applications

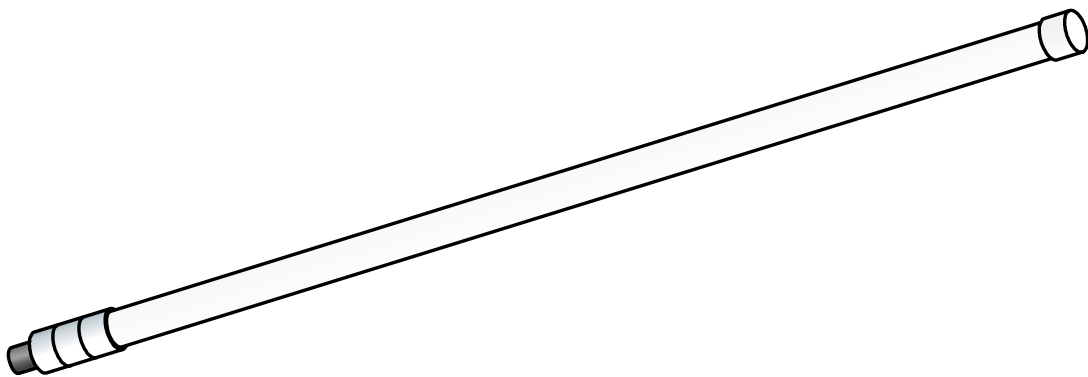

Fully compatible with technologies, products and services by



RF Explorer[®]

RFELA-2/58X 5.8dBi 863-870MHz
Fiberglass Antenna LoRa/LoRaWAN



Check latest details at lora.rf-explorer.com

Features

- ✓ High gain 5.8dBi for 868MHz band
- ✓ High efficiency vertical polarized monopole
- ✓ Robust hermetic fiberglass construction for outdoor usage
- ✓ Include easy to install mechanical support
- ✓ CE RoHS certified

Specification

Frequency Range	863-870MHz
impedance	50Ω
VSWR	1.2 typical < 2.0 maximum
Gain	5.8dBi
Efficiency Maximum	85%
Polarization	Linear Vertical
Radiation pattern	360° Omni directional
Connector	Type N Male/Jack
Radiator Material	Copper
Covering Material	Fiber Reinforced Polymer FRP White
Physical length	80 cm
Temperature operation	-30°C to +65°C / -22°F to +150°F
Waterproof	IP65

Antenna VSWR

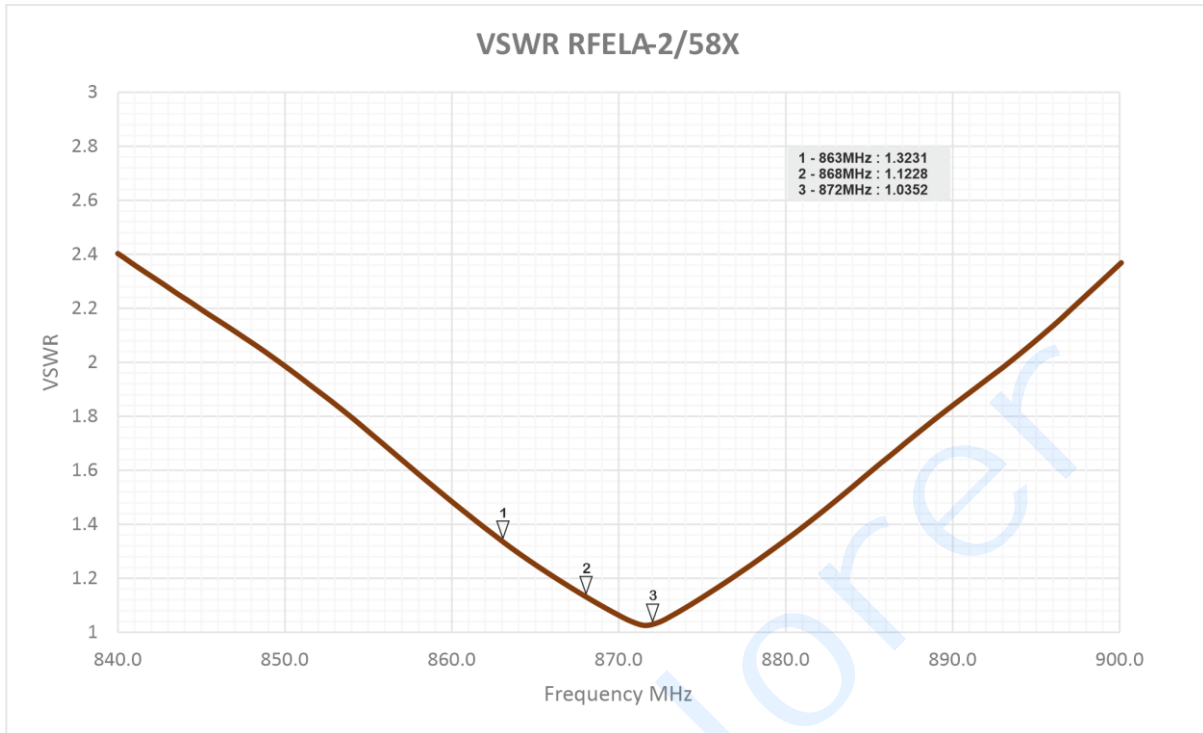

Antenna Gain

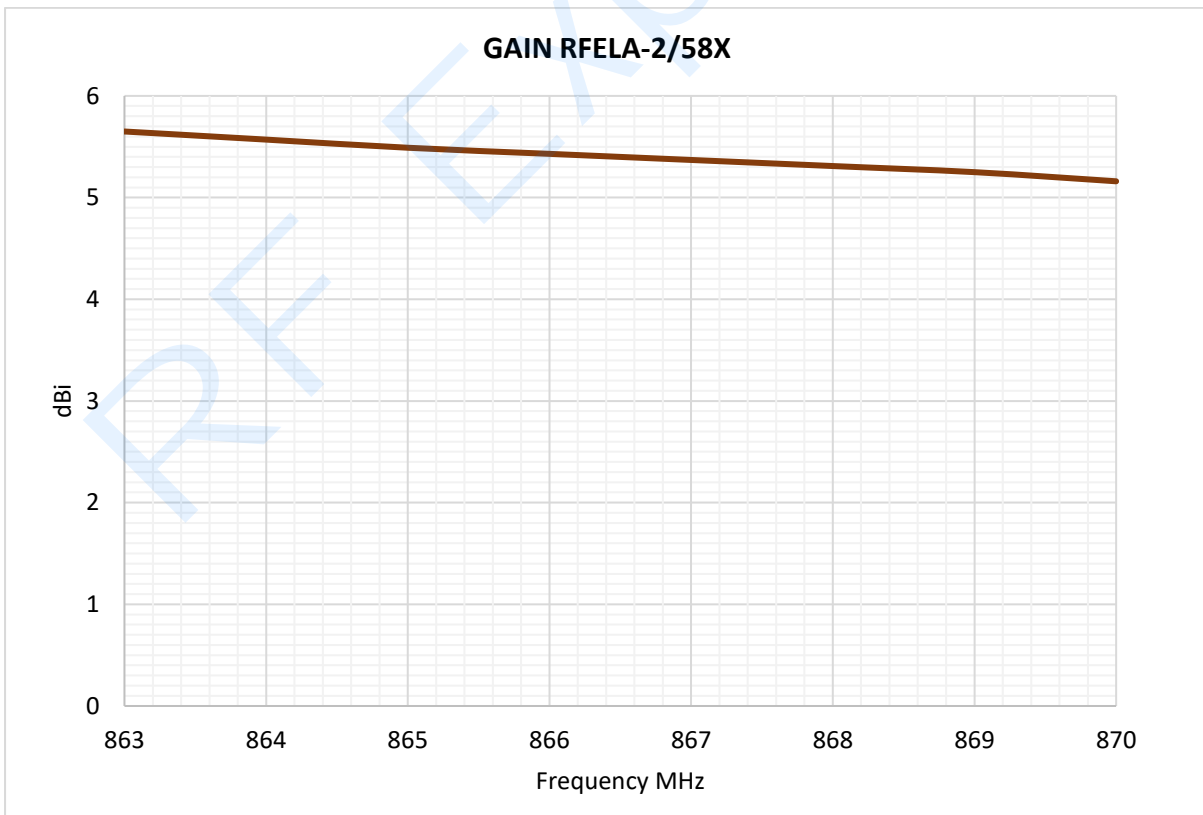

Antenna Efficiency

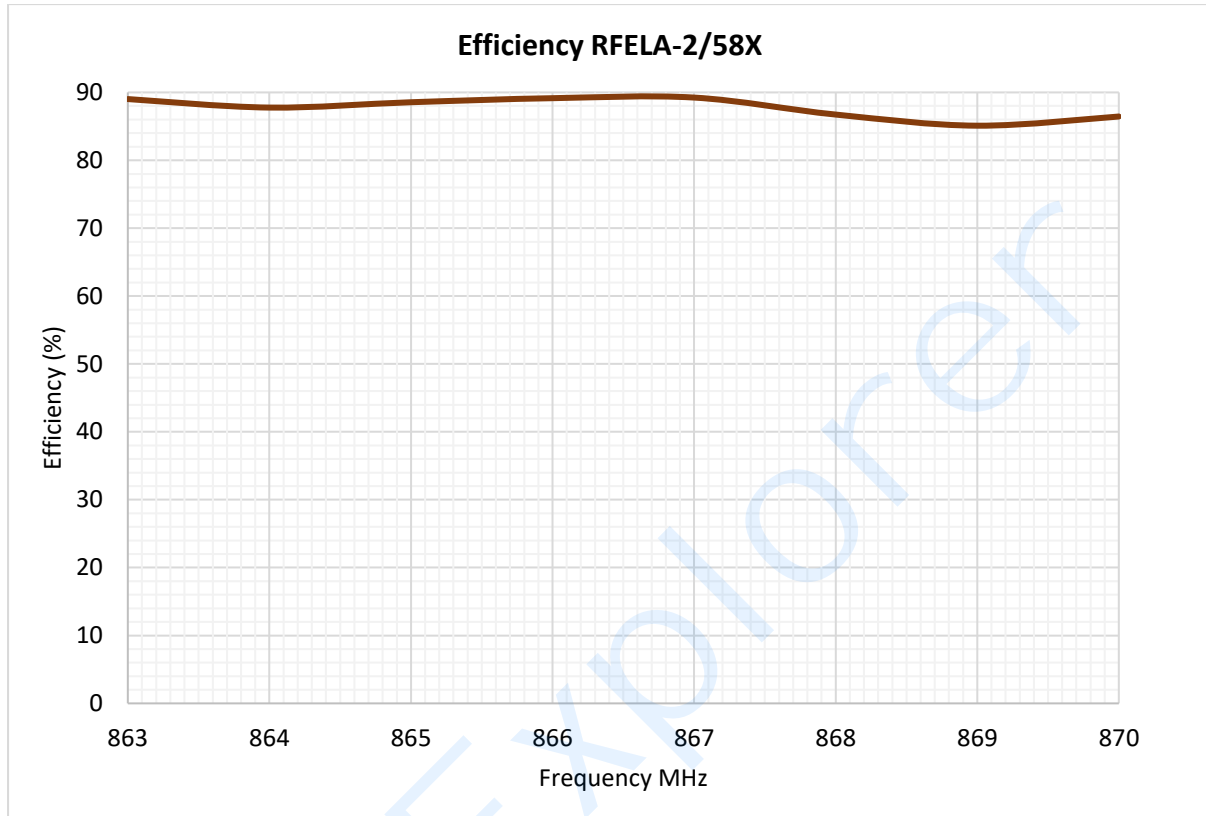

Antenna Radiation Pattern

Vertical and Horizontal radiation pattern 868MHz center frequency.

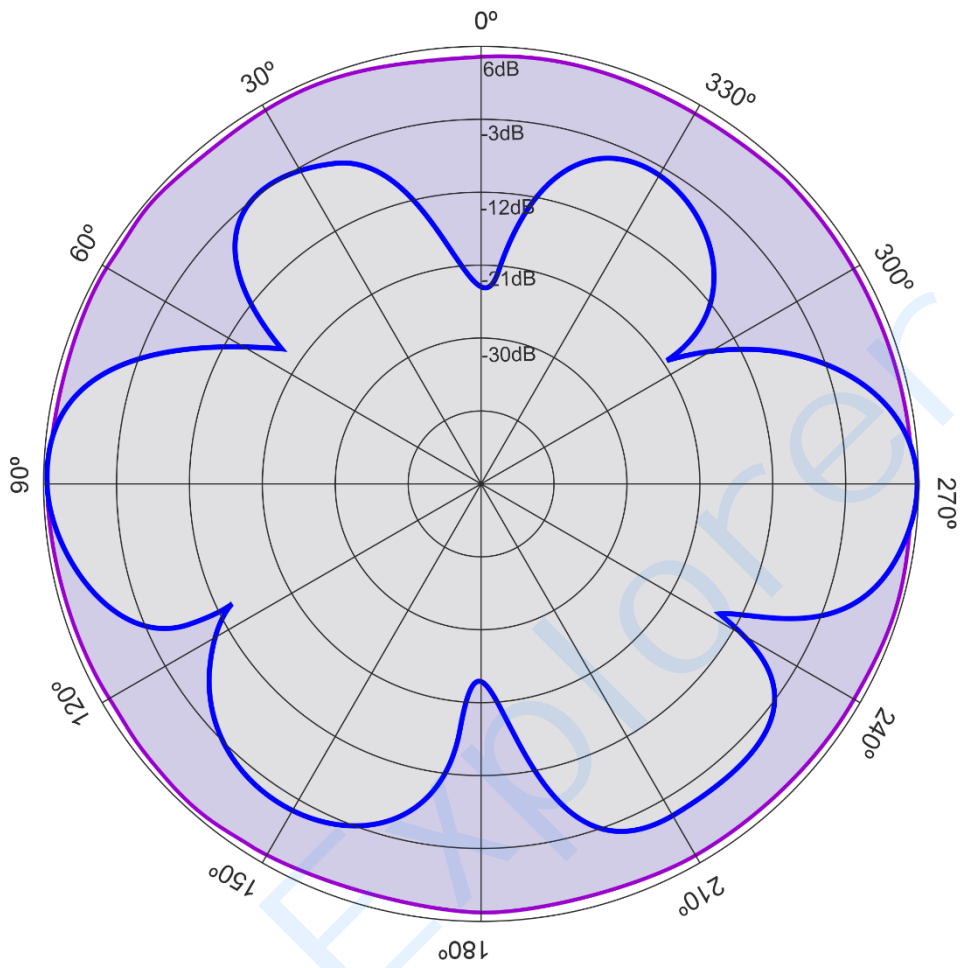

Antenna Mechanical Specifications

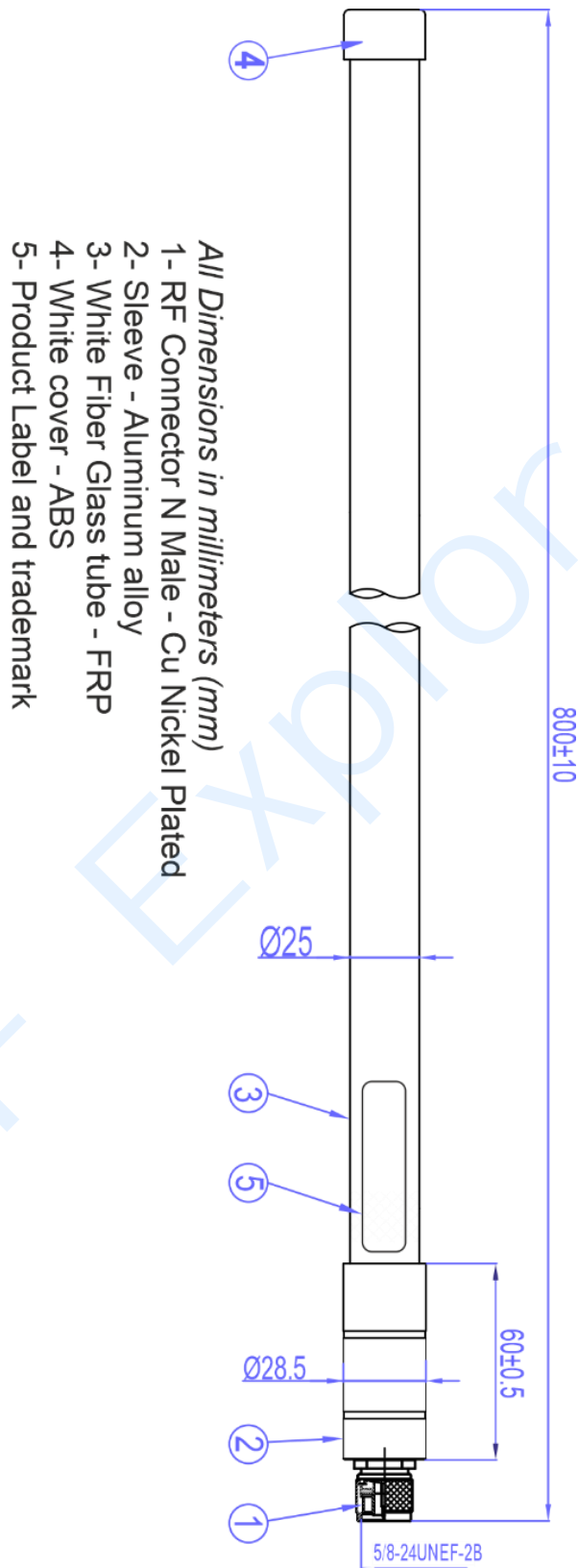

Antenna Support Mechanical Specifications

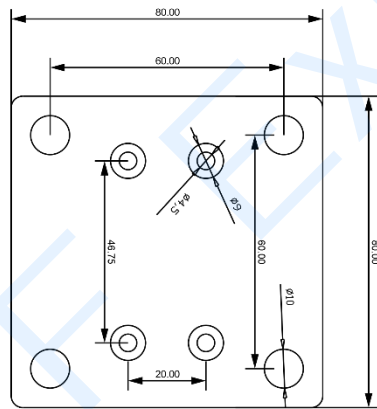
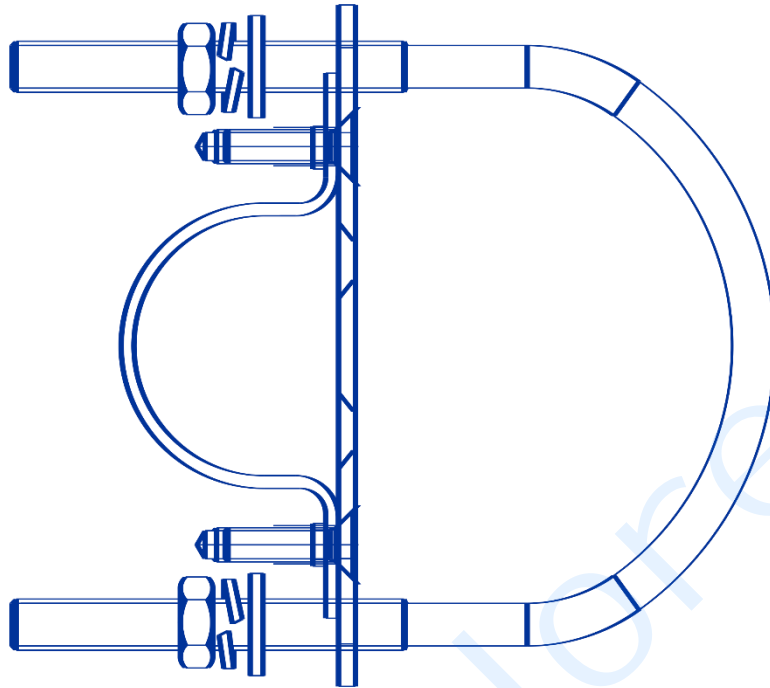

All Dimensions in millimeters (mm)
Material - Galvanized Iron
M4 size screws

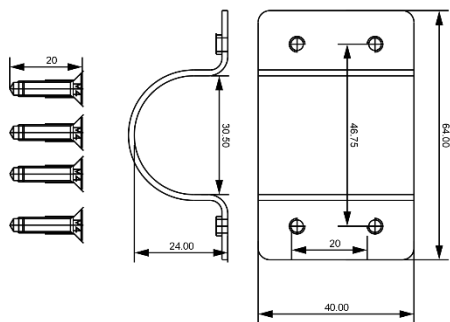
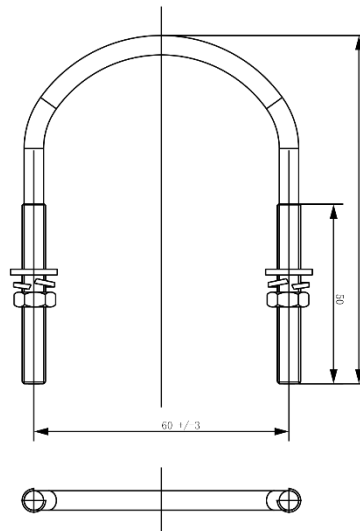

Included Cable

This antenna model includes a 1m low loss cable, matching the N antenna connector with a RP-SMA Male connector.

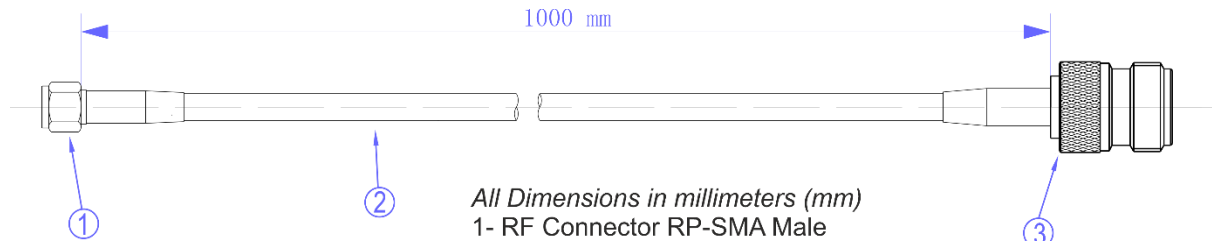

All Dimensions in millimeters (mm)

- 1- RF Connector RP-SMA Male
- 2- CFD200 cable
- 3- RF Connector N Female - Cu Nickel Plated

Structure Figure

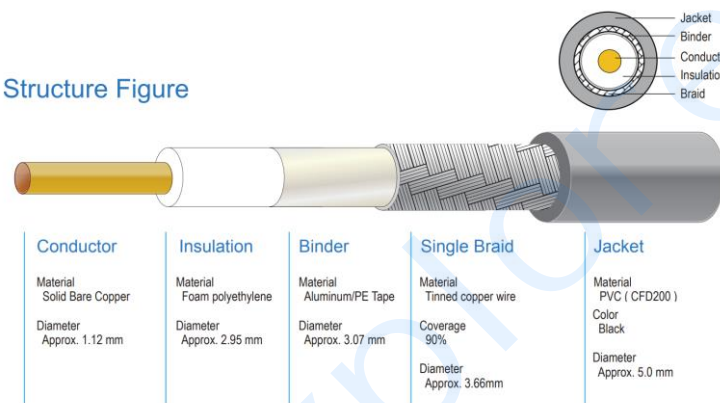

Frequency Range	0-6000MHz
Impedance	50Ω
VSWR	<2.0
Insertion Loss	< 0.5dB @ 900MHz
Insulation Resistance	> 15 MΩ
Voltage Breakdown	> 500V
External Cable Diameter	5mm
Connectors	Type N Female Type RP-SMA Male
Mating Cycles	> 500
Conductor Material	Copper
Binder Material	Aluminum/PE Tape
Braid Material	Tinned copper wire
Operation Temperature	-40°C to +65°C

Antenna Assembly

This antenna is designed to be assembled over a vertical support in 90° vertical position.

Follow below indications for optimal performance of your antenna setup.

- 1) Install on a clear location with 360 degrees open area, otherwise coverage is lower and signals may be significantly distorted, providing very poor coverage.

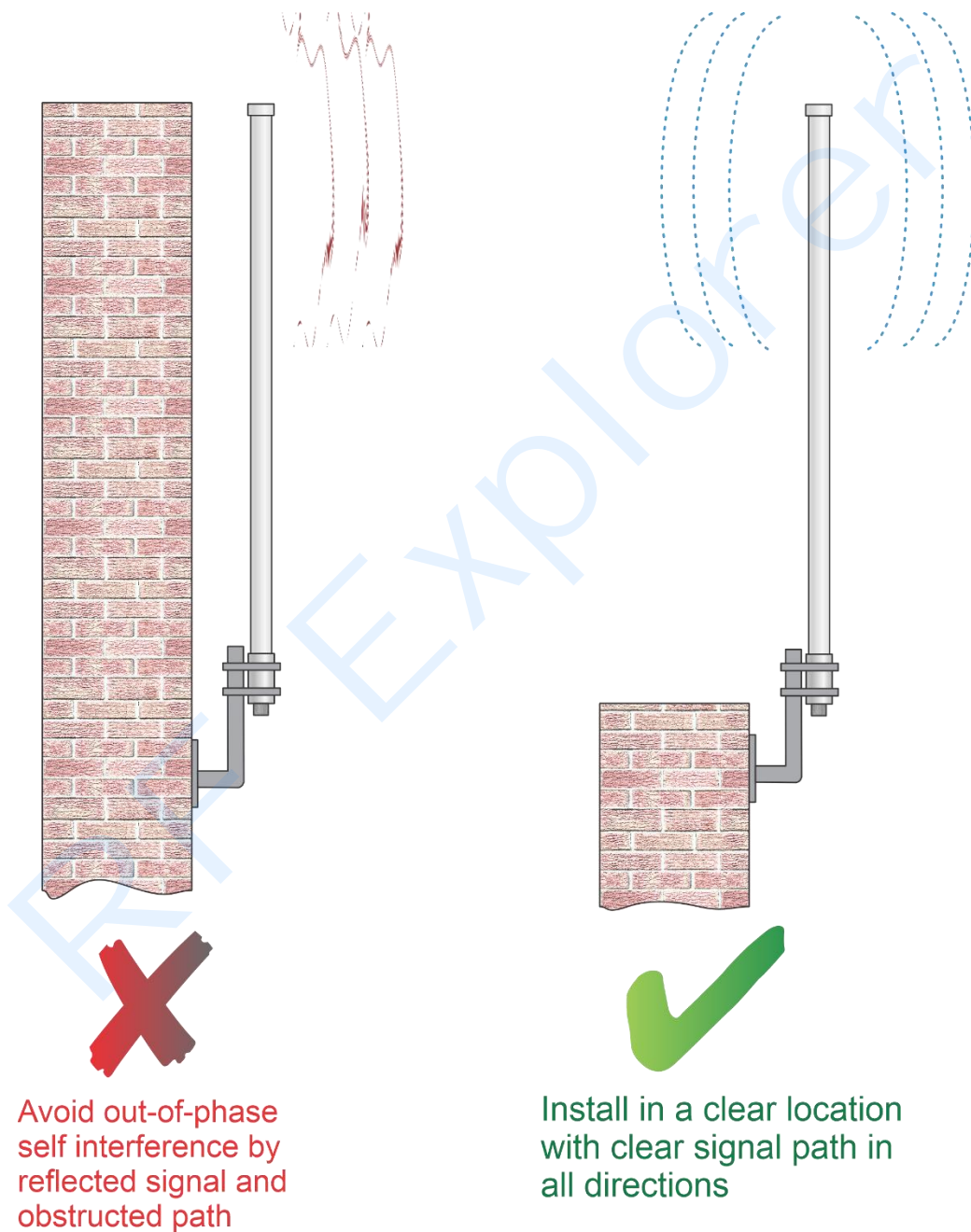

- 2) If the antenna is installed on a location with metallic objects nearby, make sure the antenna is always above such objects and as far as possible. Metallic objects and surfaces negatively impact in antenna VSWR and signal reflections.

3) Provide solid mast assembly using included antenna support



For correct mast/pole assembly, the metallic support must fully contact the metallic antenna support sleeve, not the fiber glass body.

Follow image examples for correct assembly.

4) Use LMR400 quality cables for reduced signal loss and unwanted reflections.

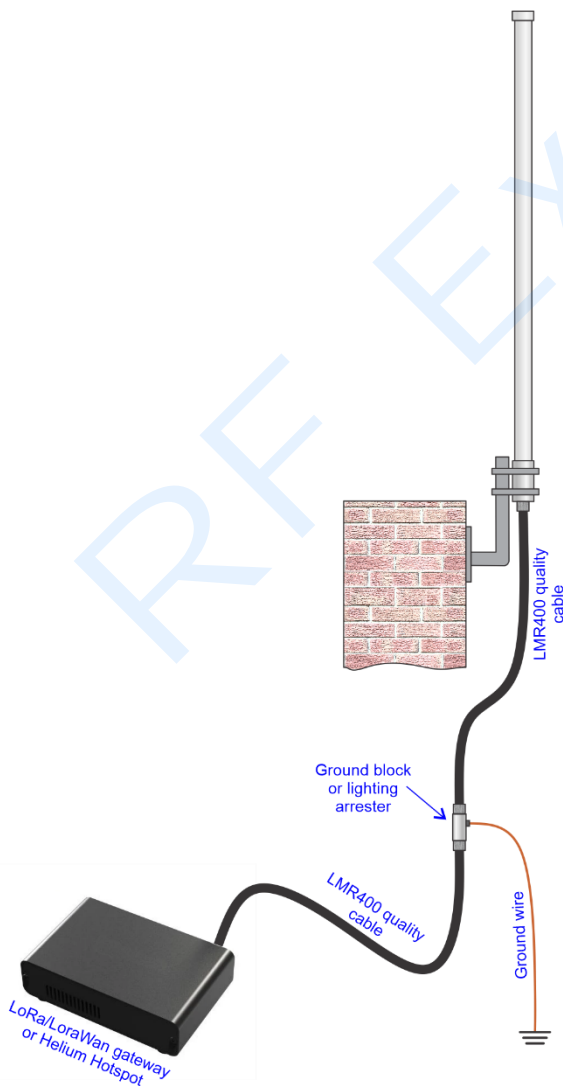

Poor quality RF cables not only reduce signal levels but also distort signals due to out of phase VSWR imbalance.

A ground block or alternatively a lightning arrester should be used to ground antenna in areas where it may be exposed to stormy weather.