

THIS DOCUMENT IS THE PROPERTY OF KEYSTONE ELECTRONICS CORP. AND SHALL NOT BE REPRODUCED, DISTRIBUTED OR USED AS A BASIS FOR MANUFACTURE WITHOUT PRIOR WRITTEN PERMISSION FROM KEYSTONE ELECTRONICS CORP.

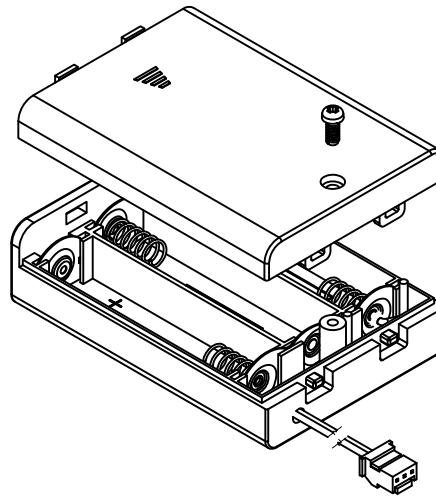

HOLDER

COVER

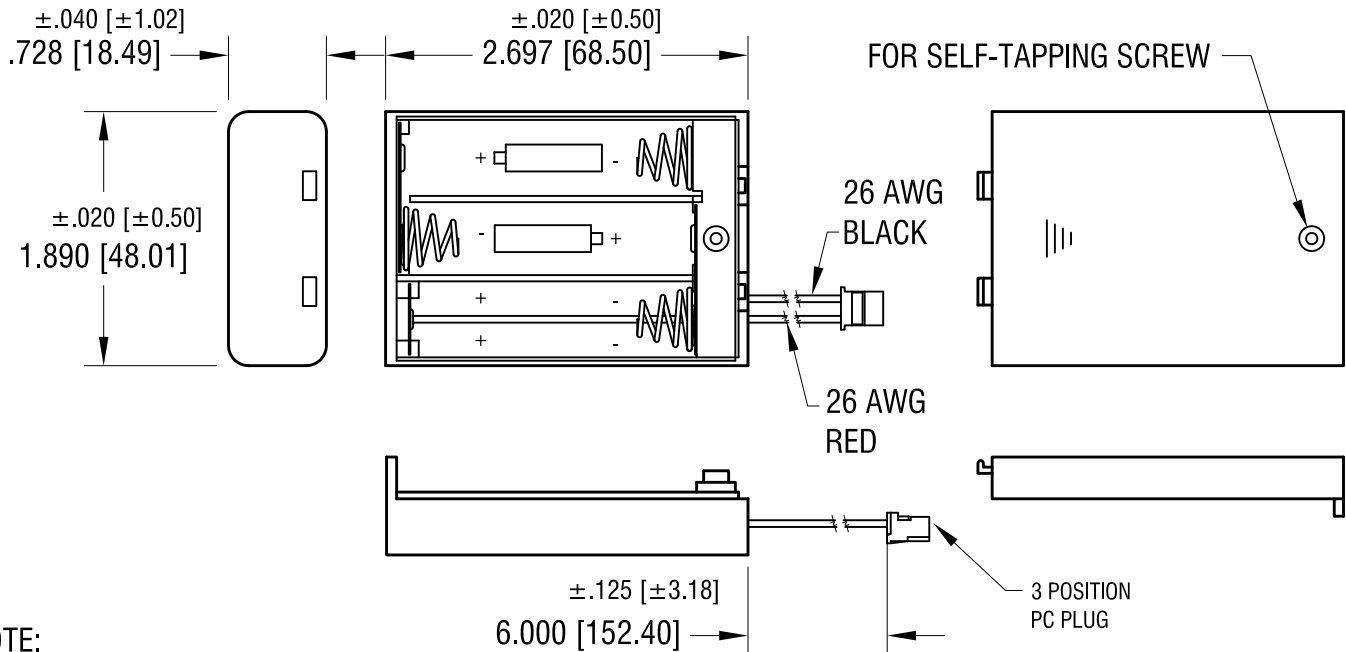

NOTE:

1. HOLDER: MAT'L: A.B.S., BLACK
2. WIRE: 26 AWG, 1007 UL/CSA APPROVED
3. SPRING: MAT'L: MUSIC WIRE, .020 [0.50] DIA.
FINISH: NICKEL PLATE
4. CONNECTOR: MAT'L - PA 66, UL94V-0
COLOR- NATURAL
5. POSITIVE (RED) CONNECTED TO PIN 1
NEGATIVE (BLACK) CONNECTED TO PIN 3

*USE : 974-977 FOR P.C. JACK

KEYSTONE ELECTRONICS CORP.			
www.keyelco.com • ASTORIA, N.Y. 11105-2017 • Tel (718) 956-8900			
PART NAME			
BATTERY HOLDER AND COVER (3) AA			
MATERIAL			
AS NOTED			
FINISH		DRN BY	DATE
AS NOTED		NT	7.20.16
		APP'D	SCALE
		LN	.7X
TOLERANCES	INCH [MM]	CODE	DWG NO.
DECIMAL	± .015 [± 0.35]	C	2487CN
ANGULAR	± 1°		
UNLESS OTHERWISE SPECIFIED			

DATE	DESCRIPTION	REV.