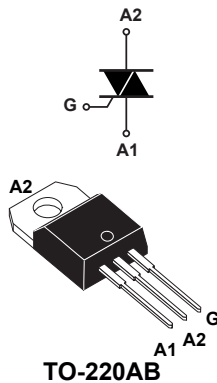

## 25 A - 800 V - T-series Triac in TO-220AB

**TO-220AB**

### Features

- 25 A medium current Triac
- 150 °C maximum junction temperature  $T_J$
- Surge capability  $V_{DSM}$ ,  $V_{RSM} = 900$  V
- Three triggering quadrants
- High noise immunity - static  $dV/dt$
- Robust dynamic turn-off commutation -  $(dI/dt)_c$
- **ECOPACK2** compliant component

### Applications

- General purpose AC line load control
- AC induction and universal motor control
- Heating: water heater, e-bidet
- Power tools
- Cooker, oven
- Lighting and automation I/O control
- Inrush current limiting circuits
- Overvoltage crowbar protection

### Description

The **T2535T-8T** Triac in TO-220AB can be used for the on/off or phase angle control function in general purpose AC switching.

Based on the ST Snubberless technology, it offers higher specified turn-off commutation and noise immunity levels up to 150 °C.

The **T2535T-8T** safely optimizes the control of the motors and heaters loads for the most constraining home appliances environments.

Product status link	
<a href="#">T2535T-8T</a>	
Product summary	
$I_{T(RMS)}$	25 A
$V_{DRM}$ , $V_{RRM}$	800 V
$V_{DSM}$ , $V_{RSM}$	900 V
$I_{GT}$	35 mA

# 1 Characteristics

**Table 1. Absolute maximum ratings (limiting values)**

Symbol	Parameter		Value	Unit
$I_{T(RMS)}$	RMS on-state current (full sine wave)		$T_c = 121\text{ °C}$ 25	A
$I_{TSM}$	Non repetitive surge peak on-state current (full cycle, $T_j$ initial = 25 °C)		$t = 16.7\text{ ms}$ 210	A
			$t = 20\text{ ms}$ 200	
$I^2t$	$I^2t$ value for fusing		$t_p = 10\text{ ms}$ 264	$A^2s$
$di/dt$	Critical rate of rise of on-state current, $I_G = 2 \times I_{GT}$ , $t_r \leq 100\text{ ns}$ , $f = 100\text{ Hz}$		$f = 120\text{ Hz}$ 100	$A/\mu s$
$V_{DRM}/V_{RRM}$	Repetitive peak off-state voltage		$T_j = 125\text{ °C}$ 800	V
			$T_j = 150\text{ °C}$ 600	
$V_{DSM}/V_{RSM}$	Non Repetitive peak off-state voltage	$t_p = 10\text{ ms}$ $T_j = 25\text{ °C}$	900	V
$I_{GM}$	Peak gate current	$t_p = 20\text{ }\mu s$ $T_j = 150\text{ °C}$	4	A
$P_{GM}$	Maximum gate power dissipation	$t_p = 20\text{ }\mu s$ $T_j = 150\text{ °C}$	5	W
$P_{G(AV)}$	Average gate power dissipation	$T_j = 150\text{ °C}$	1	W
$T_{stg}$	Storage temperature range		-40 to +150	°C
$T_j$	Operating junction temperature range		-40 to +150	°C
$T_L$	Maximum lead temperature for soldering during 10 s		260	°C

**Table 2. Electrical characteristics ( $T_j = 25\text{ °C}$ , unless otherwise specified)**

Symbol	Test conditions	Quadrants		Value	Unit
$I_{GT}$	$V_D = 12\text{ V}$ , $R_L = 30\text{ }\Omega$	I - II - III	Min.	5	mA
			Max.	35	
$V_{GT}$			Max.	1	V
$V_{GD}$	$V_D = V_{DRM}$ , $R_L = 3.3\text{ k}\Omega$ , $T_j = 150\text{ °C}$	I - II - III	Min.	0.15	V
$I_L$	$I_G = 1.2 \times I_{GT}$	I - III	Max.	50	mA
		II	Max.	80	
$I_H^{(1)}$	$I_T = 500\text{ mA}$ , gate open		Max.	35	mA
$dV/dt^{(1)}$	$V_D = 536\text{ V}$ , gate open	$T_j = 125\text{ °C}$	Min.	1500	$V/\mu s$
	$V_D = 402\text{ V}$ , gate open	$T_j = 150\text{ °C}$	Min.	1000	$V/\mu s$
$(di/dt)_c^{(1)}$	Without snubber network	$T_j = 125\text{ °C}$	Min.	28	$A/ms$
		$T_j = 150\text{ °C}$	Min.	18	$A/ms$

1. For both polarities of A2 referenced to A1.

**Table 3. Static characteristics**

Symbol	Test conditions			Value	Unit
$V_{TM}^{(1)}$	$I_T = 35\text{ A}$ , $t_p = 380\ \mu\text{s}$	$T_j = 25\text{ }^\circ\text{C}$	Max.	1.5	V
$V_{TO}^{(1)}$	Threshold voltage	$T_j = 150\text{ }^\circ\text{C}$	Max.	0.80	V
$R_D^{(1)}$	Dynamic resistance	$T_j = 150\text{ }^\circ\text{C}$	Max.	17	m $\Omega$
$I_{DRM}/I_{RRM}$	$V_D = V_R = 800\text{ V}$ , peak voltage	$T_j = 25\text{ }^\circ\text{C}$	Max.	5	$\mu\text{A}$
		$T_j = 125\text{ }^\circ\text{C}$		5	mA
	$V_D = V_R = 600\text{ V}$ , peak voltage	$T_j = 150\text{ }^\circ\text{C}$	Max.	6	mA
		$T_j = 150\text{ }^\circ\text{C}$	Max.	5	

1. For both polarities of A2 referenced to A1.

**Table 4. Thermal resistance**

Symbol	Parameter		Value	Unit
$R_{th(j-c)}$	Junction to case (AC)	Max.	1	$^\circ\text{C/W}$
$R_{th(j-a)}$	Junction to ambient	Typ.	60	

## 1.1 Characteristics (curves)

**Figure 1. Maximum power dissipation versus on-state RMS current (full cycle)**

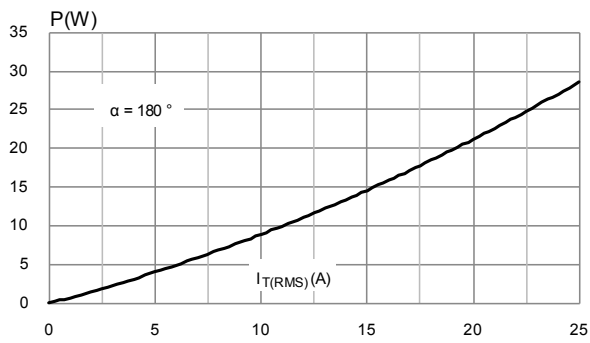

**Figure 2. On-state RMS current cycle versus case temperature (full cycle)**

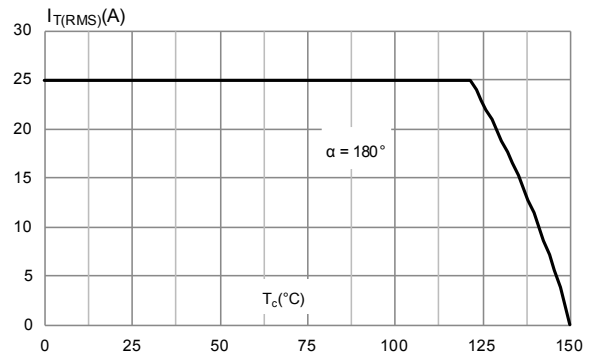

**Figure 3. On-state RMS current versus ambient temperature (free air convection)**

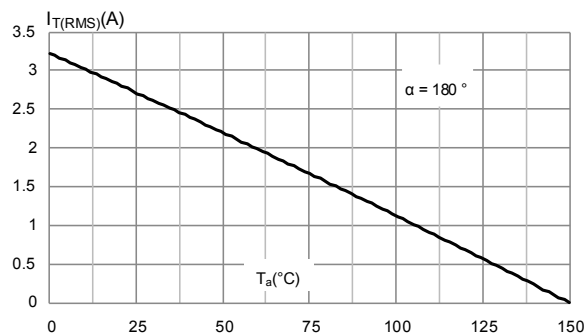

**Figure 4. On-state characteristics (maximum)**

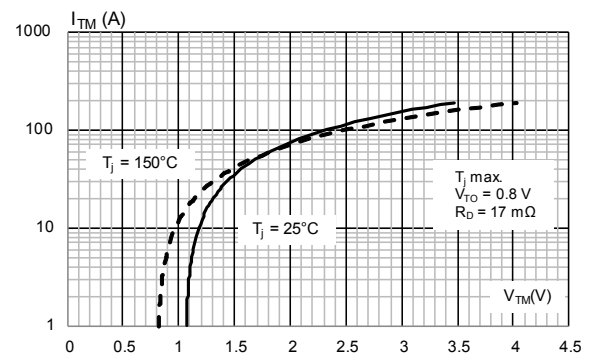

**Figure 5. Relative variation of  $I_{GT}, I_H, I_L$  vs junction temperature (typical values)**

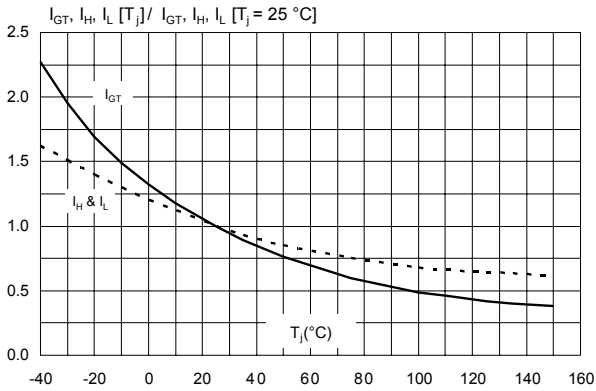

**Figure 6. Relative variation of critical rate of decrease of main current versus junction temperature**

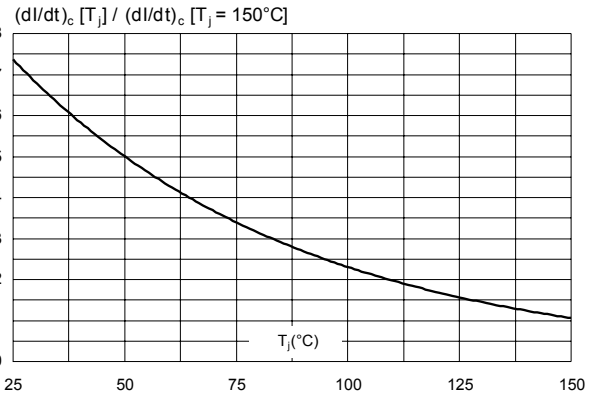

**Figure 7. Relative variation of critical rate of decrease of current  $(di/dt)_c$  versus reapplied  $(dV/dt)_c$**

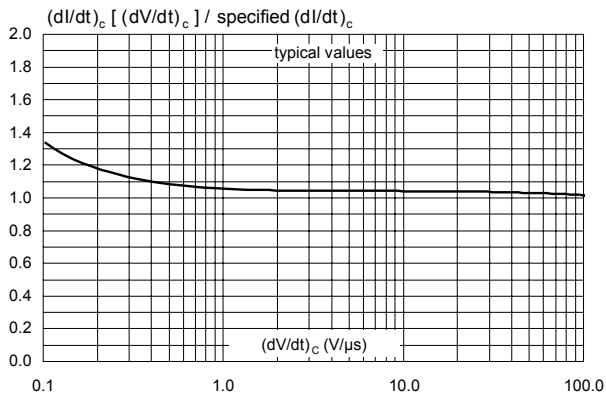

**Figure 8. Surge peak on-state current versus number of cycles**

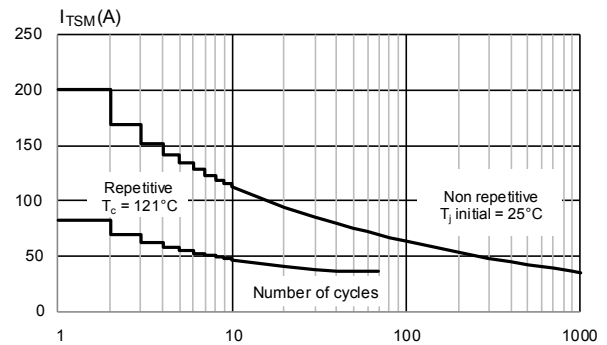

**Figure 9. Non repetitive surge peak on-state current for a sinusoidal pulse width  $t_p < 10$  ms**

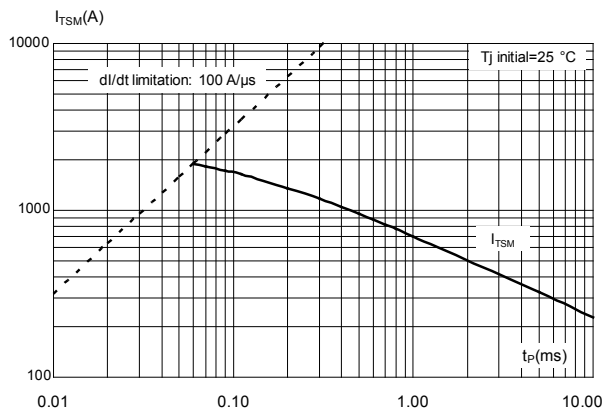

**Figure 10. Relative variation of thermal impedance versus pulse duration**

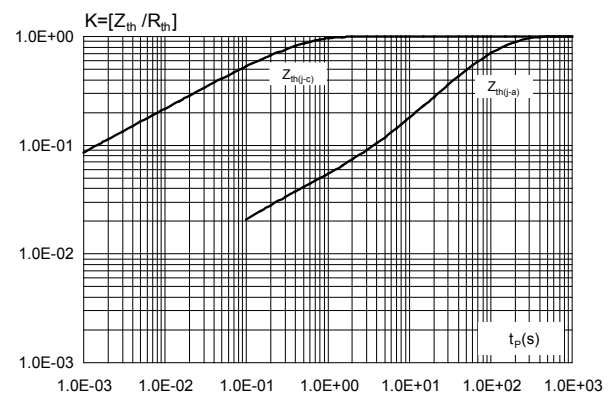
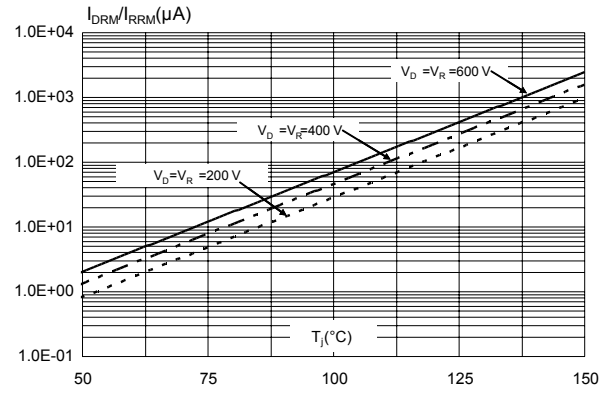

Figure 11. Leakage current versus junction temperature for different values of blocking voltage (typical values)



## 2 Package information

In order to meet environmental requirements, ST offers these devices in different grades of **ECOPACK** packages, depending on their level of environmental compliance. ECOPACK specifications, grade definitions and product status are available at: [www.st.com](http://www.st.com). ECOPACK is an ST trademark.

### 2.1 TO-220AB package information

- Molding compound resin is halogen free and meets UL94 flammability standard, level V0
- Lead-free plating package leads
- Recommended torque: 0.4 to 0.6 N·m

Figure 12. TO-220AB package outline

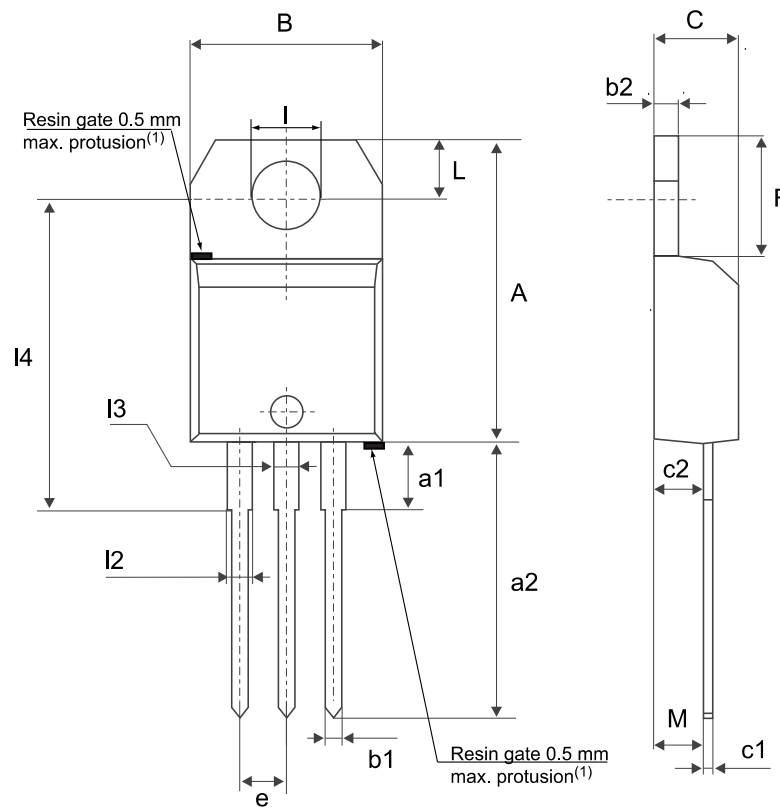

(1) Resin gate position accepted in one of the two positions or in the symmetrical opposites.

**Table 5. TO-220AB package mechanical data**

Ref.	Dimensions					
	Millimeters			Inches <sup>(1)</sup>		
	Min.	Typ.	Max.	Min.	Typ.	Max.
A	15.20		15.90	0.5984		0.6260
a1		3.75			0.1476	
a2	13.00		14.00	0.5118		0.5512
B	10.00		10.40	0.3937		0.4094
b1	0.61		0.88	0.0240		0.0346
b2	1.23		1.32	0.0484		0.0520
C	4.40		4.60	0.1732		0.1811
c1	0.49		0.70	0.0193		0.0276
c2	2.40		2.72	0.0945		0.1071
e	2.40		2.70	0.0945		0.1063
F	6.20		6.60	0.2441		0.2598
l	3.73		3.88	0.1469		0.1528
L	2.65		2.95	0.1043		0.1161
l2	1.14		1.70	0.0449		0.0669
l3	1.14		1.70	0.0449		0.0669
l4	15.80	16.40	16.80	0.6220	0.6457	0.6614
M		2.6			0.1024	

1. Inch dimensions are for reference only.

### 3 Ordering information

Figure 13. Ordering information scheme

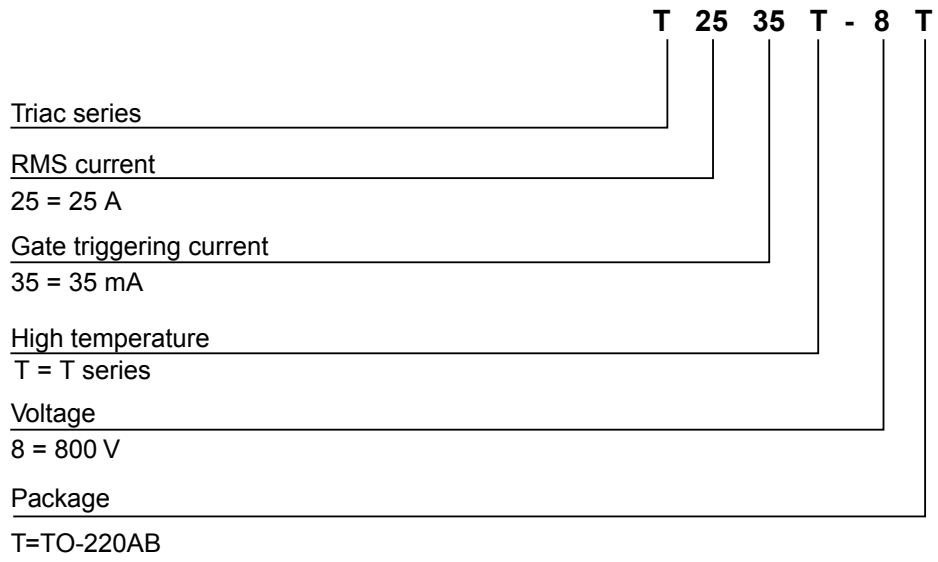

Table 6. Ordering information

Order code	Marking	Package	Weight	Base Qty.	Delivery mode
T2535T-8T	T2535T-8T	TO-220AB	2.1 g	50	Tube

## Revision history

**Table 7. Document revision history**

Date	Version	Changes
23-Sep-2020	1	Initial release.

**IMPORTANT NOTICE – PLEASE READ CAREFULLY**

STMicroelectronics NV and its subsidiaries (“ST”) reserve the right to make changes, corrections, enhancements, modifications, and improvements to ST products and/or to this document at any time without notice. Purchasers should obtain the latest relevant information on ST products before placing orders. ST products are sold pursuant to ST’s terms and conditions of sale in place at the time of order acknowledgement.

Purchasers are solely responsible for the choice, selection, and use of ST products and ST assumes no liability for application assistance or the design of Purchasers’ products.

No license, express or implied, to any intellectual property right is granted by ST herein.

Resale of ST products with provisions different from the information set forth herein shall void any warranty granted by ST for such product.

ST and the ST logo are trademarks of ST. For additional information about ST trademarks, please refer to [www.st.com/trademarks](http://www.st.com/trademarks). All other product or service names are the property of their respective owners.

Information in this document supersedes and replaces information previously supplied in any prior versions of this document.

© 2020 STMicroelectronics – All rights reserved