

3950X SERIES
3.50mm HEADERS

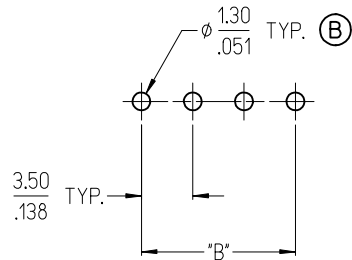

3952X & 3954X SERIES
5.00mm HEADERS
5.00mm FIXED

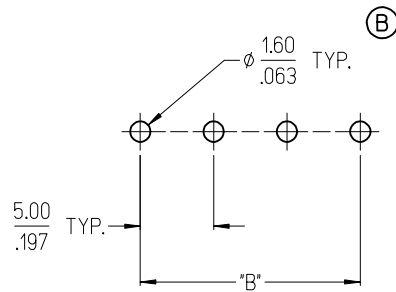

3953X SERIES
5.08mm HEADERS

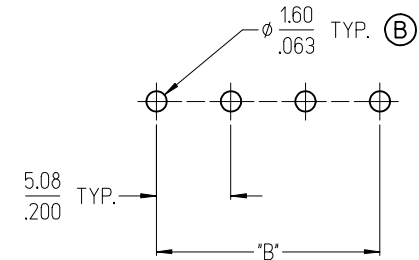

3951X SERIES
3.81mm HEADERS

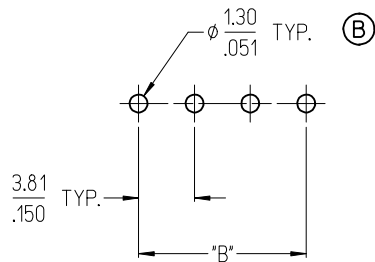

3954X SERIES
5.00mm FIXED

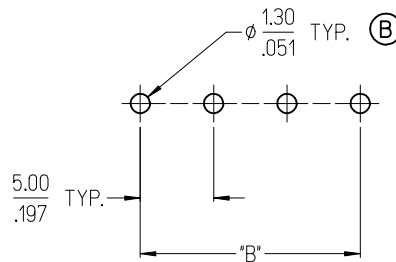

3954X SERIES
5.08mm FIXED

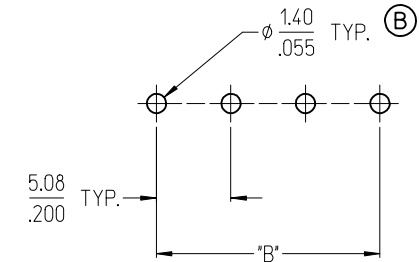

NOTES:

- REFER TO INDIVIDUAL PRODUCT SALES DRAWINGS FOR "B" DIMENSION.
- DOES NOT APPLY TO DUAL LEVEL HEADERS, SERIES 39528 AND 39538.
- TYP. = TYPICAL.

TOLERANCES			
MM	TOL	INCH	TOL
0-6	±0.25	0-.24	±.010
>6-30	±0.40	.24-1.18	±.016
>30-120	±0.50	1.18-4.76	±.020
>120	±0.80	>4.76	±.031

REVISED DOC TOL
EC NO: IPG2017-0881
DRAWN: VASUTHKARP 2017/03/23
CHKD:
APPR: BRUPERT 2017/04/18
REV DESCRIPTION

QUALITY SYMBOLS
▽=0
▽=0

GENERAL TOLERANCES (UNLESS SPECIFIED)

	mm	INCH
4 PLACES	±---	±---
3 PLACES	±---	±---
2 PLACES	±---	±---
1 PLACE	±---	±---
ANGULAR ±---°		

DRAFT WHERE APPLICABLE
MUST REMAIN
WITHIN DIMENSIONS

DIMENSION STYLE
MM/IN

DRAWN BY	DATE
C. YORK	2006/08/25
CHECKED BY	DATE
J. MACNEIL	2006/08/25
APPROVED BY	DATE
J. MACNEIL	2006/08/25

MATERIAL NO. --

SCALE DESIGN UNITS INCH

THIRD ANGLE PROJECTION

TITLE
RECOMMENDED PCB LAYOUT FOR ESE TERMINAL BLOCKS

molex MOLEX INCORPORATED

DOCUMENT NO. SD-39501-002

SHEET NO. 1 OF 1

THIS DRAWING CONTAINS INFORMATION THAT IS PROPRIETARY TO MOLEX INCORPORATED AND SHOULD NOT BE USED WITHOUT WRITTEN PERMISSION

3950X SERIES
3.50mm HEADERS

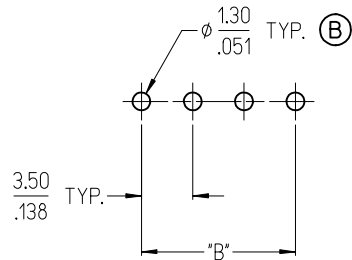

3952X & 3954X SERIES
5.00mm HEADERS
5.00mm FIXED

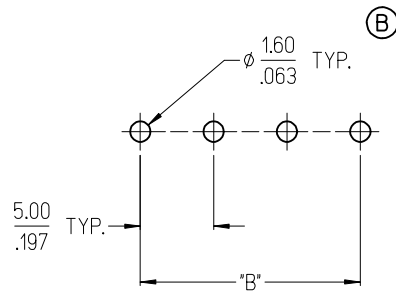

3953X SERIES
5.08mm HEADERS

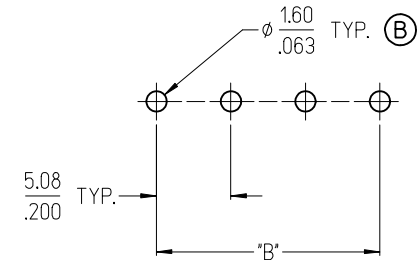

3951X SERIES
3.81mm HEADERS

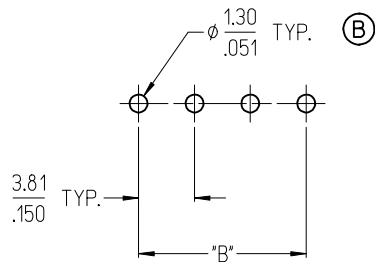

3954X SERIES
5.00mm FIXED

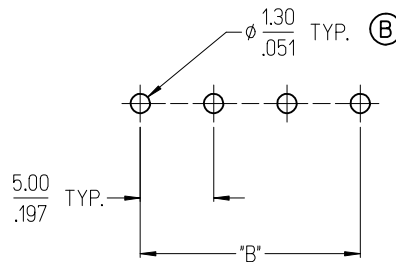

3954X SERIES
5.08mm FIXED

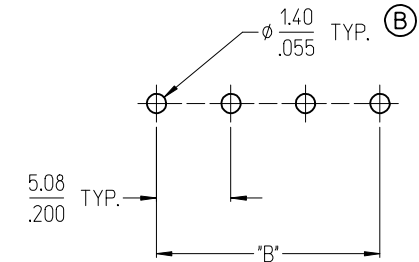

NOTES:

- REFER TO INDIVIDUAL PRODUCT SALES DRAWINGS FOR "B" DIMENSION.
- DOES NOT APPLY TO DUAL LEVEL HEADERS, SERIES 39528 AND 39538.
- TYP. = TYPICAL.

TOLERANCES			
MM	TOL	INCH	TOL
0-6	±0.25	0-.24	±.010
>6-30	±0.40	.24-1.18	±.016
>30-120	±0.50	1.18-4.76	±.020
>120	±0.80	>4.76	±.031

REVISED DOC TOL
EC NO: IPG2017-0881
DRAWN: VASUTHKARP 2017/03/23
CHKD:
APPR: BRUPERT 2017/04/18
REV DESCRIPTION

QUALITY SYMBOLS
▽=0
▽=0

GENERAL TOLERANCES (UNLESS SPECIFIED)

	mm	INCH
4 PLACES	±---	±---
3 PLACES	±---	±---
2 PLACES	±---	±---
1 PLACE	±---	±---
ANGULAR ±---°		

DRAFT WHERE APPLICABLE
MUST REMAIN
WITHIN DIMENSIONS

DIMENSION STYLE
MM/IN

DRAWN BY	DATE
C. YORK	2006/08/25
CHECKED BY	DATE
J. MACNEIL	2006/08/25
APPROVED BY	DATE
J. MACNEIL	2006/08/25

MATERIAL NO. --

SCALE DESIGN UNITS INCH

THIRD ANGLE PROJECTION

RECOMMENDED PCB LAYOUT FOR ESE TERMINAL BLOCKS

molex MOLEX INCORPORATED

DOCUMENT NO. SD-39501-002

SHEET NO. 1 OF 1

THIS DRAWING CONTAINS INFORMATION THAT IS PROPRIETARY TO MOLEX INCORPORATED AND SHOULD NOT BE USED WITHOUT WRITTEN PERMISSION

F

E

D

C

B

A

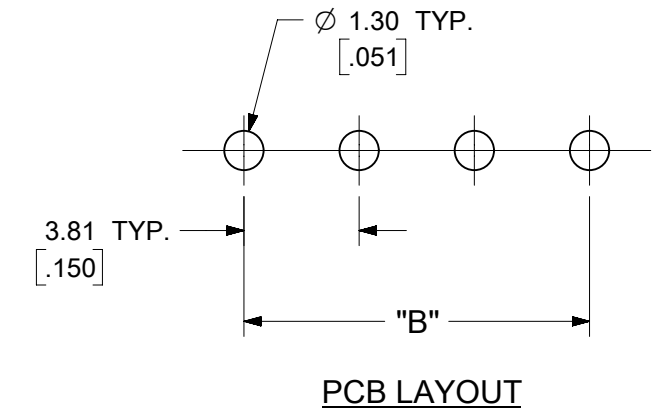
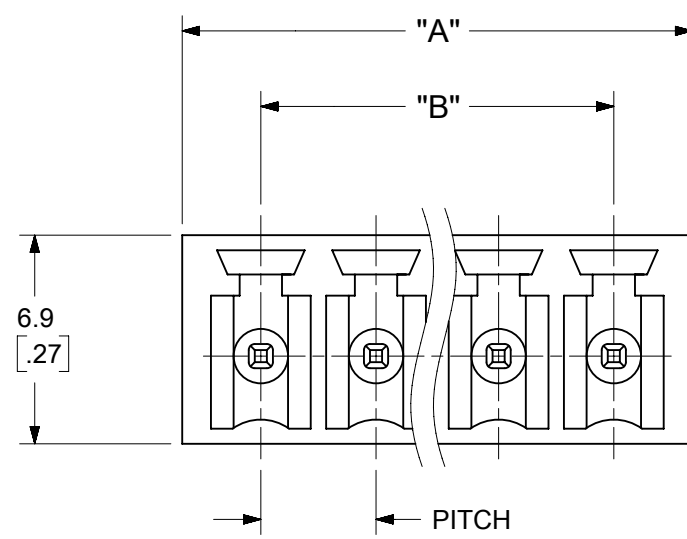
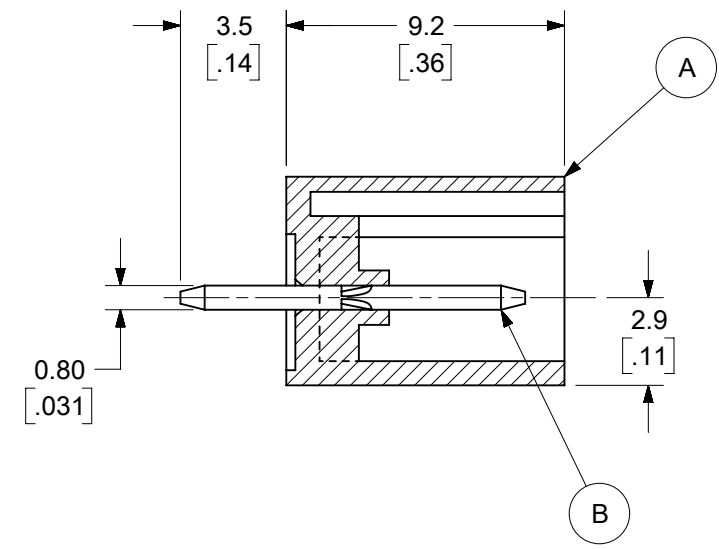
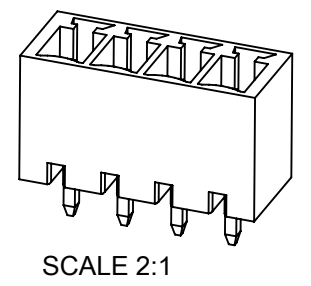
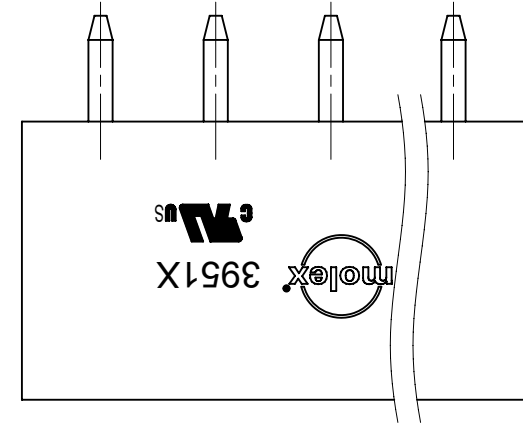

SPECIFICATIONS:

1. MATERIAL:
 - (A). BODY: PA66
 - (B). TERMINAL: BRASS
2. WIRE RANGE: N/A
3. ELECTRICAL RATING: 300V, 8A.
4. MAX TORQUE: N/A.
5. WIRE STRIP LENGTH: N/A.
6. OPERATING TEMPERATURE: -40°C to +105°C.
7. $A = (N \times P) + 1.39\text{MM}$
8. $B = (N - 1) \times P$
9. P (PITCH) = 3.81MM (.150").
10. N = NUMBER OF POSITIONS AVAILABLE 2 THROUGH 20.

TOLERANCES			
MM	TOL	INCH	TOL
0-6	±0.25	0-.24	±.010
>6-30	±0.40	.24-1.18	±.016
>30-120	±0.50	1.18-4.76	±.020
>120	±0.80	>4.76	±.031

SYMBOLS DIMENSION UNITS: MM/INCH SCALE: 4:1 GENERAL TOLERANCES (UNLESS SPECIFIED): 4 PLACES ± 3 PLACES ± 2 PLACES ± 1 PLACE ± 0 PLACES ± ANGULAR TOL ± ° DRAFT WHERE APPLICABLE MUST REMAIN WITHIN DIMENSIONS	THIS DRAWING CONTAINS INFORMATION THAT IS PROPRIETARY TO MOLEX ELECTRONIC TECHNOLOGIES, LLC AND SHOULD NOT BE USED WITHOUT WRITTEN PERMISSION		CURRENT REV DESC: MIGRATION TO ECTR/NX			
	EC NO: 619929 DRWN: ABENJAMINLW 2019/06/17 CHK'D: DACHAMMER 2019/07/01 APPR: JFMURPHY 2019/07/08		INITIAL REVISION: DRWN: LROTHAUS 2006/01/09 APPR: JPAWLICK 2006/01/10			3.81MM, EURO HEADER VERTICAL, CLOSED END
PRODUCT CUSTOMER DRAWING			DOCUMENT NUMBER: SD-39511-001	DOC TYPE: PSD	DOC PART: 001	REVISION: B2
MATERIAL NUMBER: SEE SHEET-2	CUSTOMER: GENERAL MARKET	SERIES: 39511	DRAFTING: B-SIZE	THIRD ANGLE PROJECTION	SHEET NUMBER: 1 OF 2	

DESCRIPTION	CIRCUIT SIZE	MATERIAL NUMBERS												DIMENSIONAL INFORMATION			
		BLACK						GREEN									
		100% TIN			30 u" GOLD			100% TIN			30 u" GOLD			DIM. "A"		DIM. "B"	
		PRINTING OPTIONS			PRINTING OPTIONS			PRINTING OPTIONS			PRINTING OPTIONS			mm	inch	mm	inch
		None	10AV	11AV	None	10AV	11AV	None	10AV	11AV	None	10AV	11AV				
3.81MM, EURO HEADER, VERTICAL	2	395111002	395111302	395111402	395111502	395111802	395111902	395116002	395116302	395116402	395116502	395116802	395116902	9.01	.355	3.81	.150
3.81MM, EURO HEADER, VERTICAL	3	395111003	395111303	395111403	395111503	395111803	395111903	395116003	395116303	395116403	395116503	395116803	395116903	12.82	.505	7.62	.300
3.81MM, EURO HEADER, VERTICAL	4	395111004	395111304	395111404	395111504	395111804	395111904	395116004	395116304	395116404	395116504	395116804	395116904	16.63	.655	11.43	.450
3.81MM, EURO HEADER, VERTICAL	5	395111005	395111305	395111405	395111505	395111805	395111905	395116005	395116305	395116405	395116505	395116805	395116905	20.44	.805	15.24	.600
3.81MM, EURO HEADER, VERTICAL	6	395111006	395111306	395111406	395111506	395111806	395111906	395116006	395116306	395116406	395116506	395116806	395116906	24.25	.955	19.05	.750
3.81MM, EURO HEADER, VERTICAL	7	395111007	395111307	395111407	395111507	395111807	395111907	395116007	395116307	395116407	395116507	395116807	395116907	28.06	1.105	22.86	.900
3.81MM, EURO HEADER, VERTICAL	8	395111008	395111308	395111408	395111508	395111808	395111908	395116008	395116308	395116408	395116508	395116808	395116908	31.87	1.255	26.67	1.050
3.81MM, EURO HEADER, VERTICAL	9	395111009	395111309	395111409	395111509	395111809	395111909	395116009	395116309	395116409	395116509	395116809	395116909	35.68	1.405	30.48	1.200
3.81MM, EURO HEADER, VERTICAL	10	395111010	395111310	395111410	395111510	395111810	395111910	395116010	395116310	395116410	395116510	395116810	395116910	39.49	1.555	34.29	1.350
3.81MM, EURO HEADER, VERTICAL	11	395111011	395111311	395111411	395111511	395111811	395111911	395116011	395116311	395116411	395116511	395116811	395116911	43.30	1.705	38.10	1.500
3.81MM, EURO HEADER, VERTICAL	12	395111012	395111312	395111412	395111512	395111812	395111912	395116012	395116312	395116412	395116512	395116812	395116912	47.11	1.855	41.91	1.650
3.81MM, EURO HEADER, VERTICAL	13	395111013	395111313	395111413	395111513	395111813	395111913	395116013	395116313	395116413	395116513	395116813	395116913	50.92	2.005	45.72	1.800
3.81MM, EURO HEADER, VERTICAL	14	395111014	395111314	395111414	395111514	395111814	395111914	395116014	395116314	395116414	395116514	395116814	395116914	54.73	2.155	49.53	1.950
3.81MM, EURO HEADER, VERTICAL	15	395111015	395111315	395111415	395111515	395111815	395111915	395116015	395116315	395116415	395116515	395116815	395116915	58.54	2.305	53.34	2.100
3.81MM, EURO HEADER, VERTICAL	16	395111016	395111316	395111416	395111516	395111816	395111916	395116016	395116316	395116416	395116516	395116816	395116916	62.35	2.455	57.15	2.250
3.81MM, EURO HEADER, VERTICAL	17	395111017	395111317	395111417	395111517	395111817	395111917	395116017	395116317	395116417	395116517	395116817	395116917	66.16	2.605	60.96	2.400
3.81MM, EURO HEADER, VERTICAL	18	395111018	395111318	395111418	395111518	395111818	395111918	395116018	395116318	395116418	395116518	395116818	395116918	69.97	2.755	64.77	2.550
3.81MM, EURO HEADER, VERTICAL	19	395111019	395111319	395111419	395111519	395111819	395111919	395116019	395116319	395116419	395116519	395116819	395116919	73.78	2.905	68.58	2.700
3.81MM, EURO HEADER, VERTICAL	20	395111020	395111320	395111420	395111520	395111820	395111920	395116020	395116320	395116420	395116520	395116820	395116920	77.59	3.055	72.39	2.850

TOLERANCES			
MM	TOL	INCH	TOL
0-6	±0.25	0-.24	±.010
>6-30	±0.40	.24-1.18	±.016
>30-120	±0.50	1.18-4.76	±.020
>120	±0.80	>4.76	±.031

SYMBOLS	THIS DRAWING CONTAINS INFORMATION THAT IS PROPRIETARY TO MOLEX ELECTRONIC TECHNOLOGIES, LLC AND SHOULD NOT BE USED WITHOUT WRITTEN PERMISSION		
	DIMENSION UNITS	SCALE	CURRENT REV DESC: MIGRATION TO ECTR/NX
▽ = 0	MM/INCH	2:1	EC NO: 619929 DRWN: ABENJAMINLW 2019/06/17 CHK'D: DACHAMMER 2019/07/01 APPR: JFMURPHY 2019/07/08
▽ = 0	GENERAL TOLERANCES (UNLESS SPECIFIED)		
▽ = 0	4 PLACES ±	±	INITIAL REVISION: DRWN: LROTHAUS 2006/01/09 APPR: JPAWLICK 2006/01/10
▽ = 0	3 PLACES ±	±	
▽ = 0	2 PLACES ±	±	DOCUMENT NUMBER: SD-39511-001 DOC TYPE: PSD DOC PART: 001 REVISION: B2
▽ = 0	1 PLACE ±	±	
▽ = 0	0 PLACES ±	±	MATERIAL NUMBER: SEE TABLE CUSTOMER: GENERAL MARKET SHEET NUMBER: 2 OF 2
▽ = 0	ANGULAR TOL ± °	± °	
▽ = 0	DRAFT WHERE APPLICABLE MUST REMAIN WITHIN DIMENSIONS		THIRD ANGLE PROJECTION DRAWING: B-SIZE SERIES: 39511