



TAOGLAS®



Datasheet

Part No:
TU.60.3H31

Description:

Terminal Mount 3.5-8GHz 3dBi Ultra-wideband Antenna with N-Type Connector
For European and USA UWB Applications In Channels 2-7

Features:

Frequency: 3.5-8GHz
Covering USA and European UWB Channels 2-7
Dipole Antenna – No Ground Plane Required
Rugged ABS, IP67 Rated Enclosure
N Type Male Connector
Dimensions: Length 123.5mm, \varnothing 22.8mm
CE Certified
RoHS & Reach Compliant



1. Introduction	3
2. Specifications	4
3. Antenna Characteristics	5
4. Radiation Patterns	7
5. Mechanical Drawing	11
6. Installation Guide	12
7. Packaging	13
8. Application Note	14
<hr/>	
Changelog	19

Taoglas makes no warranties based on the accuracy or completeness of the contents of this document and reserves the right to make changes to specifications and product descriptions at any time without notice. Taoglas reserves all rights to this document and the information contained herein. Reproduction, use or disclosure to third parties without express permission is strictly prohibited.



1. Introduction



The Taoglas TU.60.3H31 is a unique dipole terminal ultra-wideband (known as UWB) antenna designed to cover all worldwide UWB frequencies between 3.5 and 8 GHz. With excellent efficiency and an omnidirectional radiation pattern with 3 dBi gain, it provides strong, homogeneous coverage in all directions from the sensor. The TU.60 also shows excellent fidelity factor numbers and low group delay variation to preserve maximum signal integrity.

The potential of UWB is enabling a wave of applications that use highly accurate, ultra-reliable location and distance sensing to deliver new experiences and capabilities. It operates with low power for transmitting large amounts of digital data over a wide spectrum of frequency bands typically spanning more than 500MHz with very low power for short distances up to 250m with latency speeds as low as 1ms. The low power requirements of UWB results in increased battery life of sensors and tags which in turn reduces overall operational costs. The TU.60 exhibits exceptional efficiencies of up to 91% on specific bands.

Typical Applications Include:

- Indoor position location and tracking applications
- Smart home device control and entertainment systems
- Keyless entry systems
- Precision surveying

The TU.60 is a powerful antenna packaged in a small IP67 rated enclosure that is manufactured from ABS which makes it an ideal ruggedized solution for both indoor and outdoor environments. It comes with an N-Type connector as standard for robust and easy installation. The connector can be customized subject to NRE.

The TU.60 is one of several Taoglas-developed antennas designed for seamless integration and compatibility with any UWB sensor module on the market. Contact your regional Taoglas customer support team for further information.

2. Specifications

Electrical						
Standard	UWB Channel 2	UWB Channel 3	UWB Channel 4	UWB Channel 5	UWB Channel 6	UWB Channel 7
Frequency (GHz)	3.75~4.25	4.25 ~4.75	6.25~6.75	6.75~7.25	7.25~7.75	7.75~8.25
Efficiency (%)						
Free Space	87.3	87.28	91.41	75.53	78.60	79.84
Peak Gain (dBi)						
Free Space	2.11	3.13	5.34	5.06	5.18	5.46
Average Gain (dB)						
Free Space	-0.57	-0.65	-0.85	-1.13	-1.04	-0.97
VSWR						
Free Space	< 3:1	<2.3:1	< 2:1	< 2:1	< 2.3:1	< 2:1
Return Loss	< -10dB					
Impedance	50Ω					
Polarization	Linear					
Radiation Pattern	Omnidirectional					
Input Power	50W					
Mechanical						
Dimensions	Length 123.5mm, Ø22.8mm					
Ingress Protection Rating	IP67					
Casing	ABS					
Connector	N-Type (M)					
Weight	52g					
Recommended Mounting Torque	5 Nm					
Max Torque for Mounting	15 Nm					
Environmental						
Operational Temp Range	-40°C to 85°C					
Humidity	Non-condensing 65°C 95% RH					
RoHS Compliant	Yes					
REACH Compliant	Yes					

3. Antenna Characteristics

3.1 Return Loss

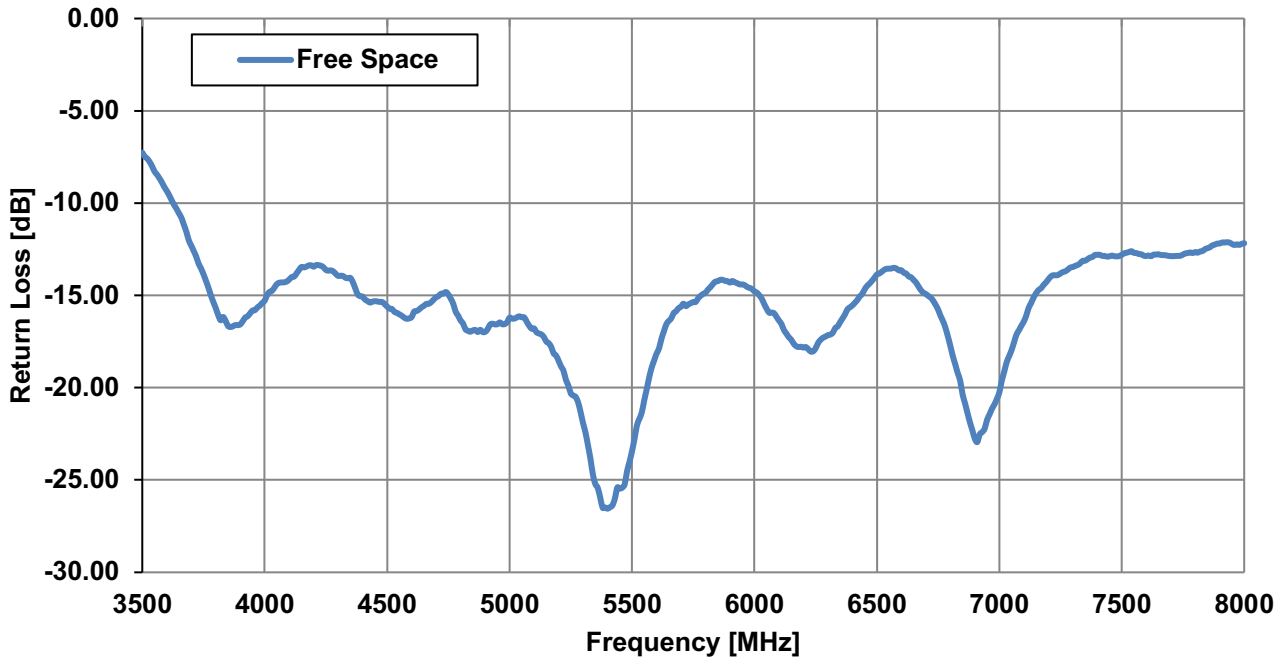

3.2 Efficiency

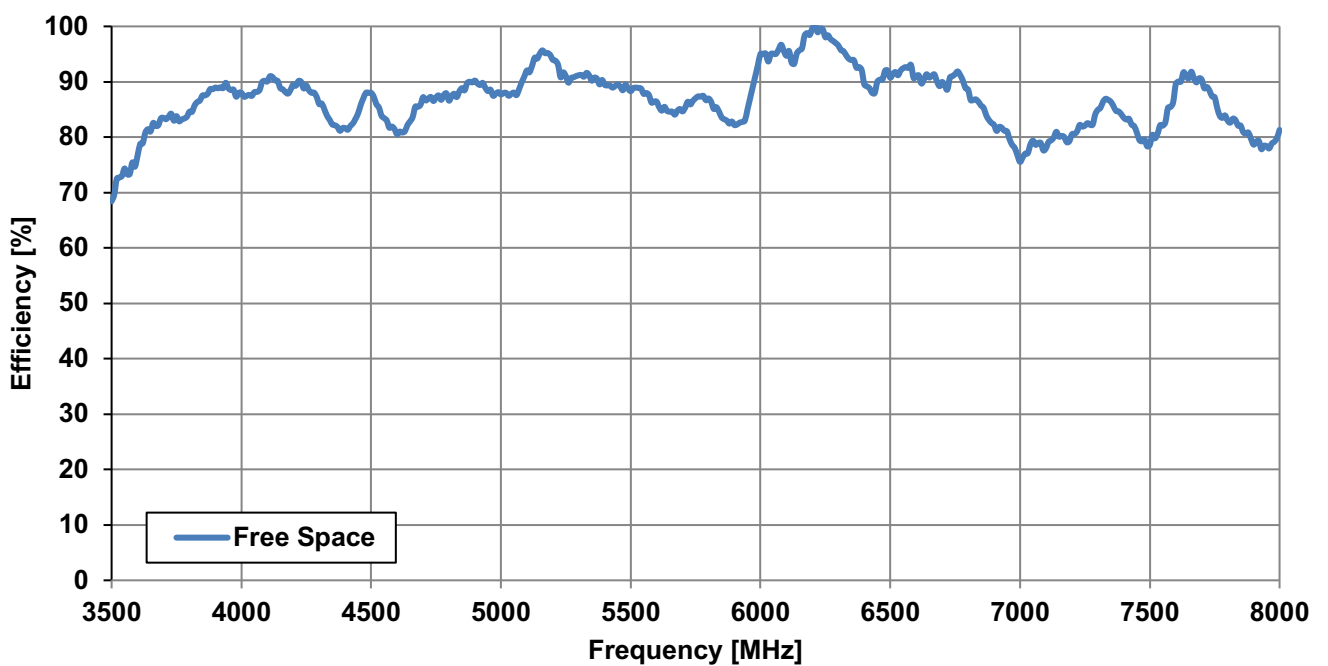

3.3 Average Gain

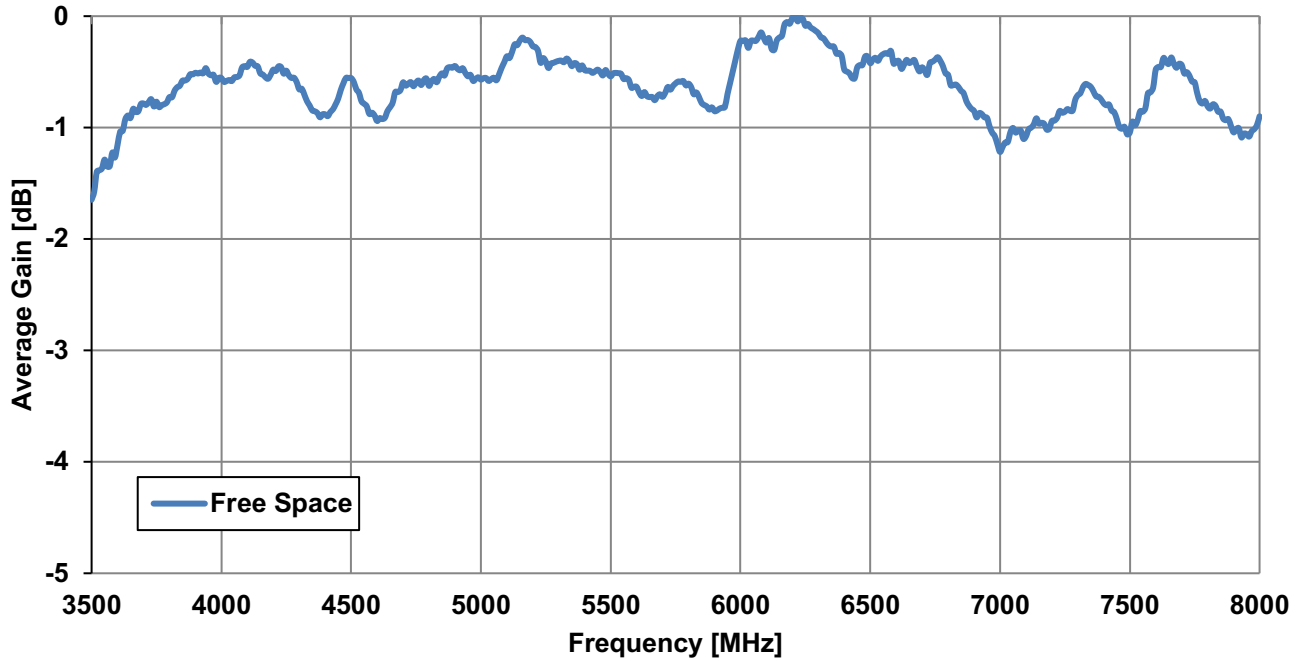

3.4 Peak Gain

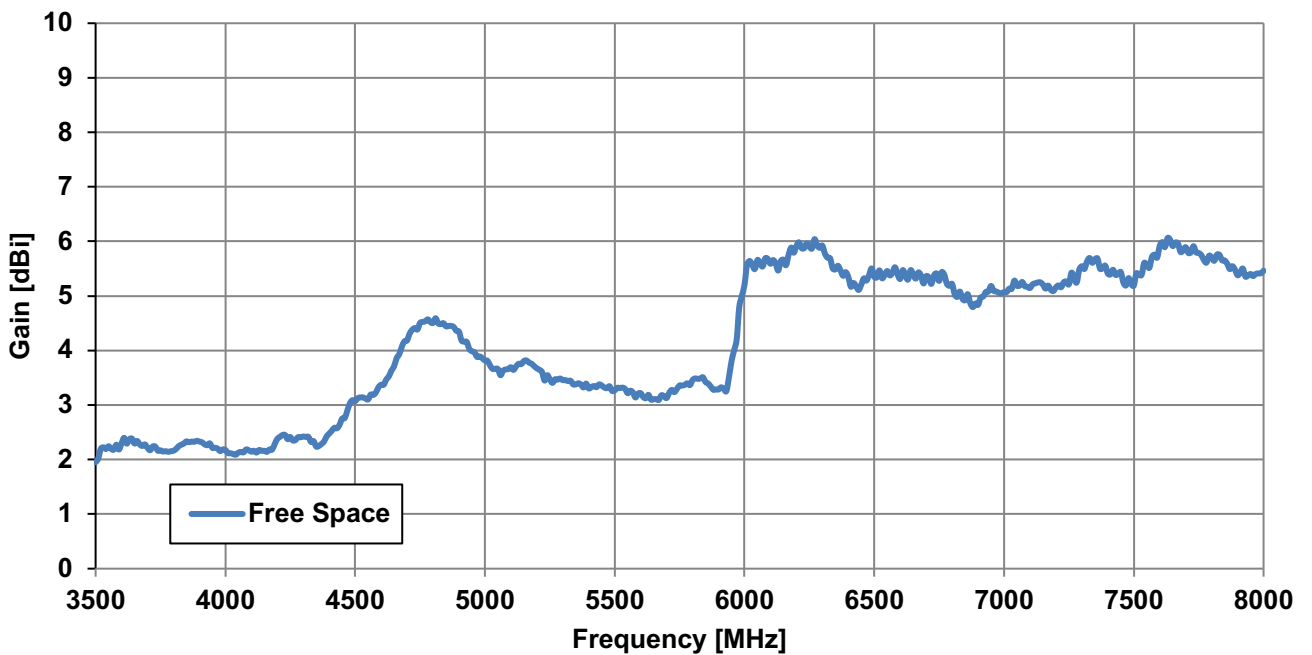

4. Radiation Patterns

4.1 Test Setup – Free Space



4.2 4000-6500MHz 3D and 2D Radiation Patterns

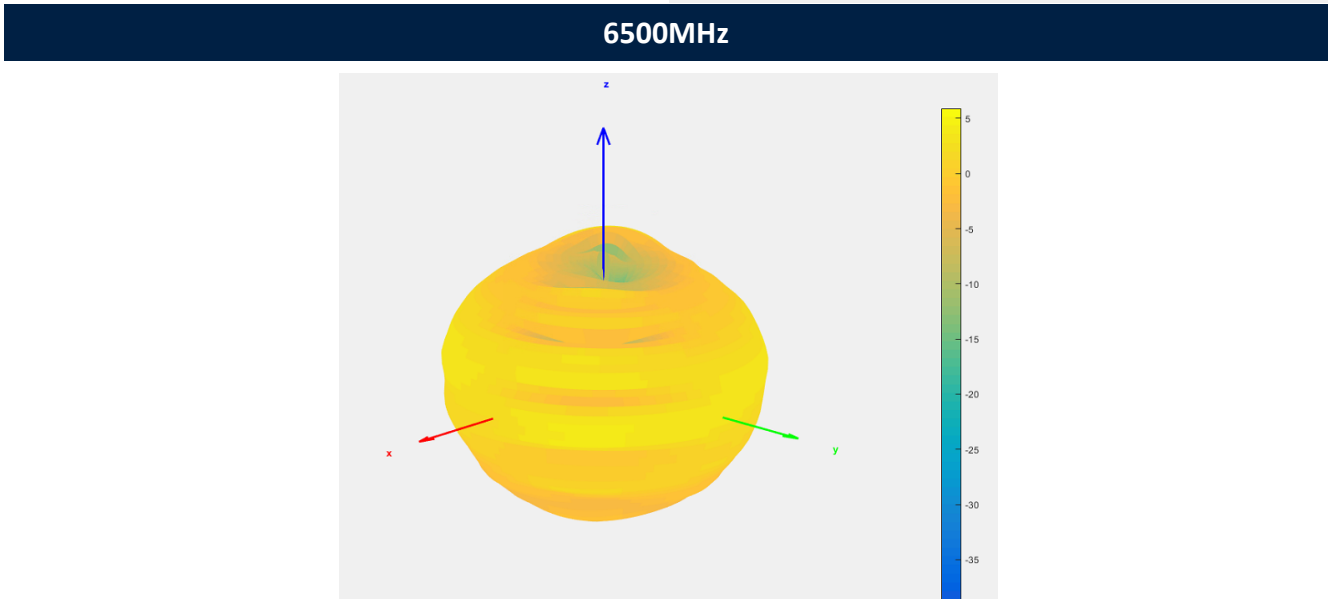
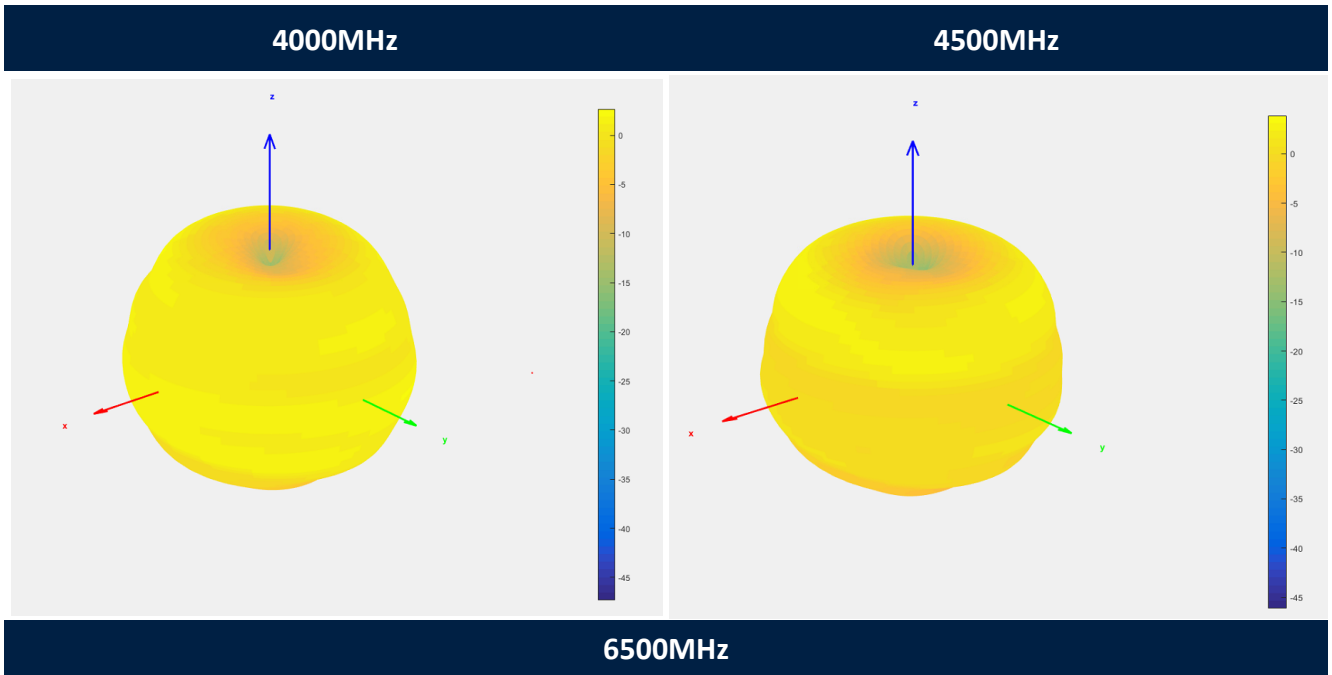

XY Plane XZ Plane YZ Plane

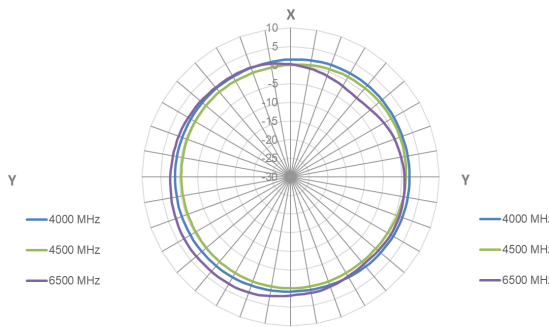
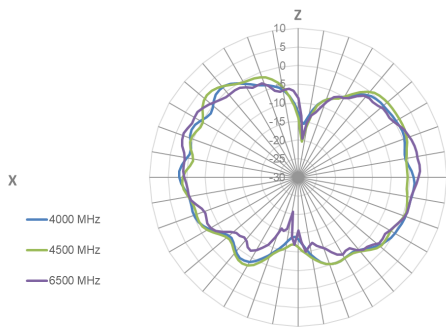
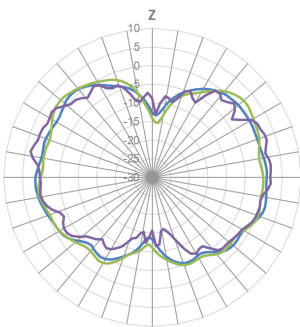

4.3 7000-8000MHz 3D and 2D Radiation Patterns

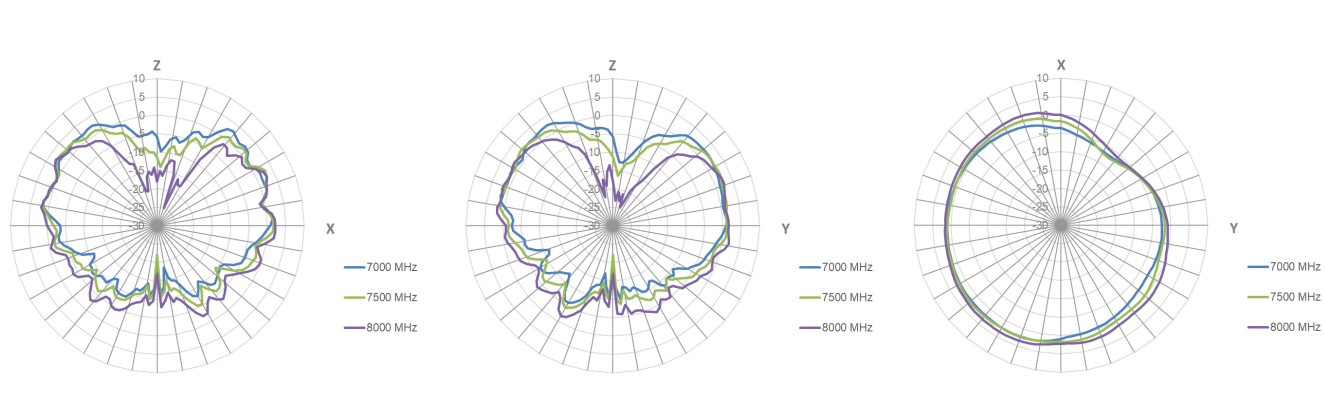
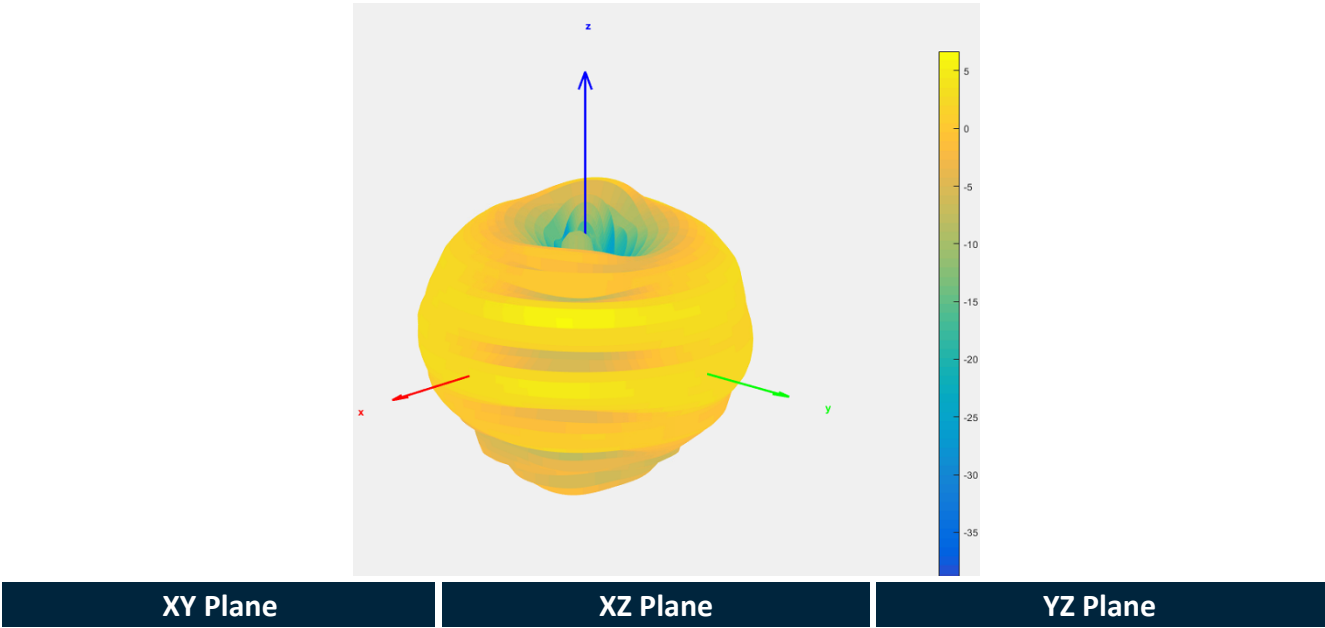
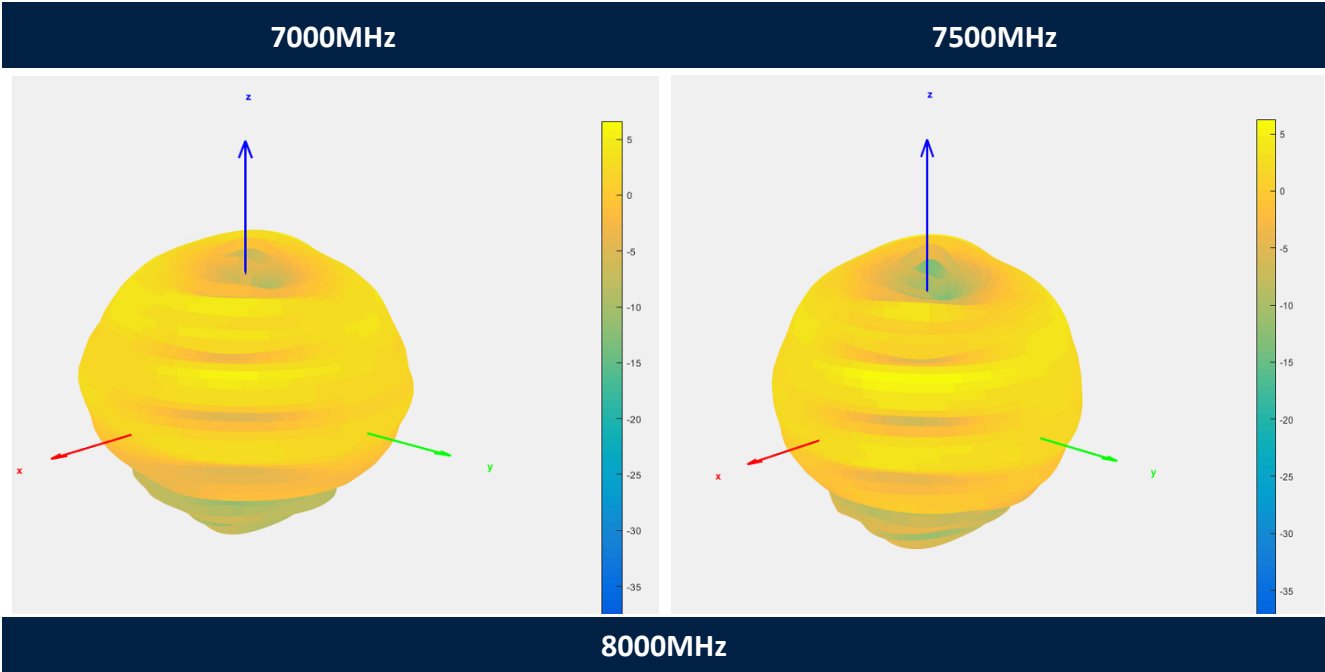

4.4 Group Delay – peak to peak variation over angle

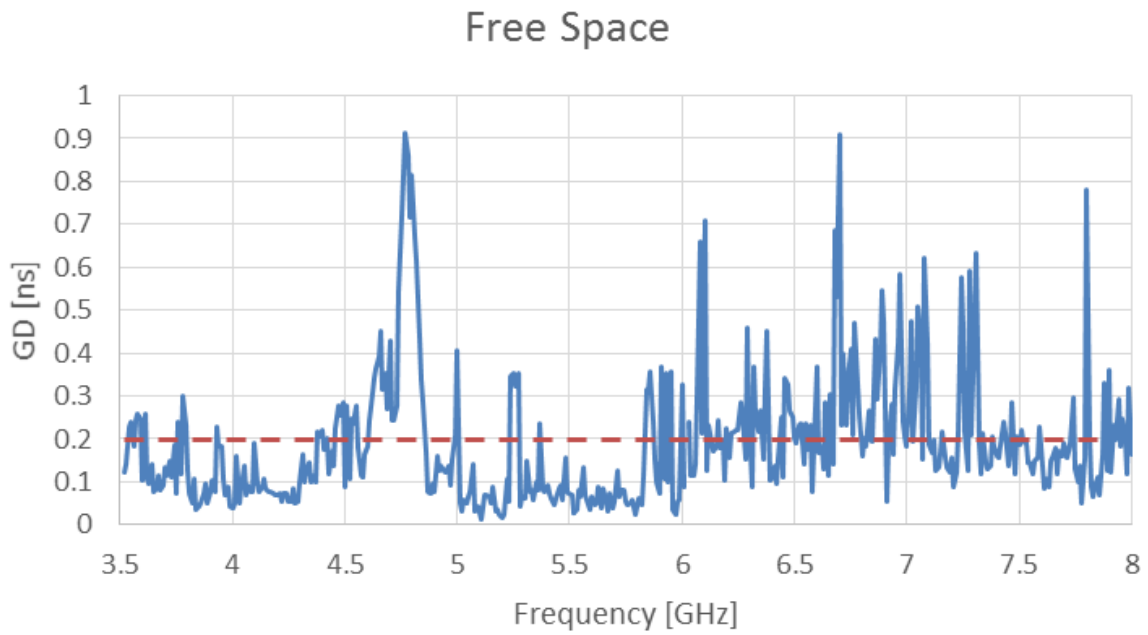

5. Mechanical Drawing

ISO NO.: EDW-20-8-0041

STATE: Release

NOTES:

1. Frequency Range: 3-8GHz
2. VSWR < 1.5
3. Tolerance: Unmarked tolerance refer to the standard tolerance please.

REV.	DESCRIPTION	ENG.	APPROVED	DATE
01	Initial Design	Joey	Clark	2020/01/16
02	Correct frequency range	Joey	Aaron	2020/02/27

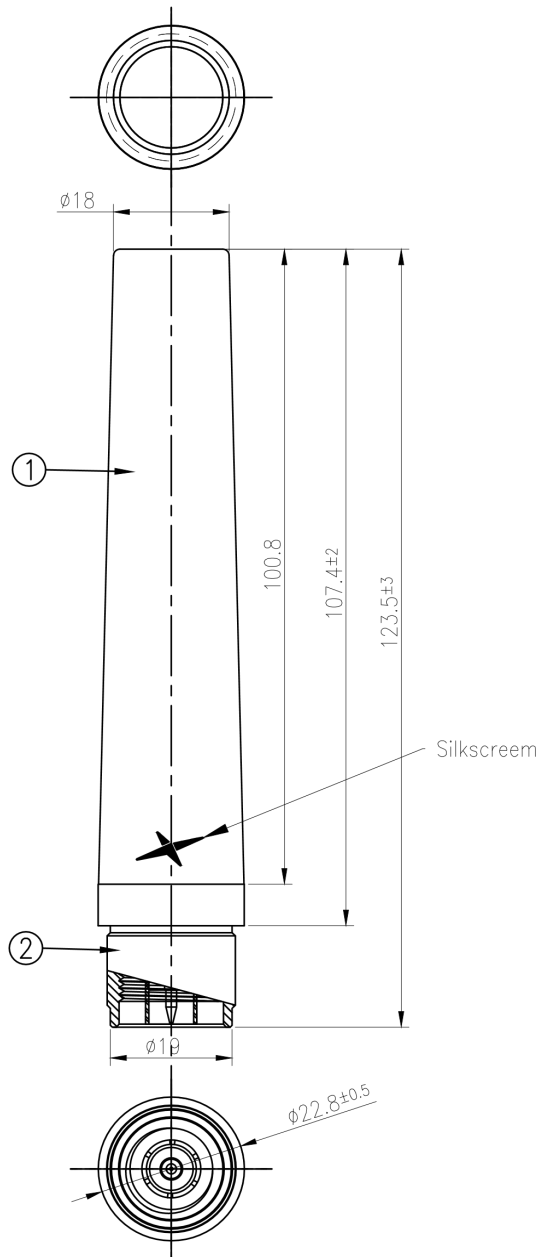

	Name	Material	Finish	QTY
1	N-Type(U)	Brass	NI plated	1
2	TU.60 Housing	ABS	Black	1

APPROVED BY: Clark	 TW Design Centre This drawing and its inherent design concepts are property of Taoglas. Not to be copied or given to third parties without the written consent of Taoglas.
CHECK BY: Aaron	
DRAWN BY: Joey	
DATE: 2020/01/16	
UNLESS OTHERWISE SPECIFIED TOLERANCES ON:	TITLE : Terminal Mount 3-8GHz 3dBi Ultra Wideband Antenna with N-Type Connector - Logo PART NO. : TU.60.3H31
THIRD ANGLE PROJECTION	UNIT: mm SCALE: 1:1 PAGES: 1/1 REV. D02

6. Installation Recommendations

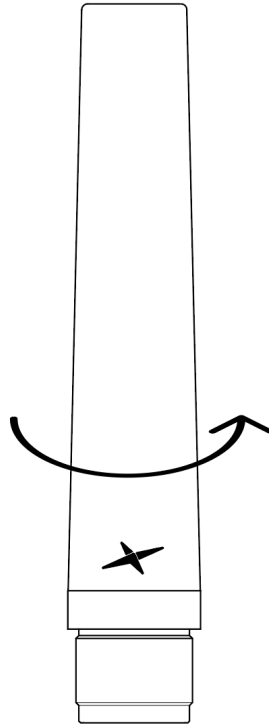

The recommended mounting torque for the TU.60 is 5 Nm

The maximum torque that can be applied is 15 Nm.
Anything in excess of this value may cause damage to the product.

7. Packaging

1pc TU.60.3H31 per PE Bag
Weight: 52g



10pcs TU.60.3H31 per Large PE Bag
Weight: 540g

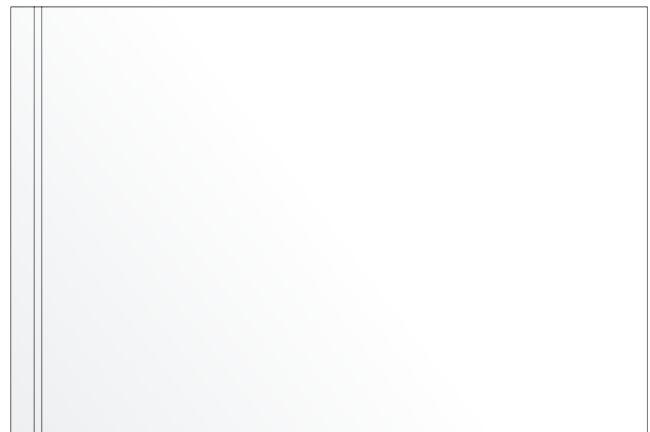

100pcs TU.60.3H31 per Carton
Dimensions: 260*160*155mm
Weight: 5.8Kg

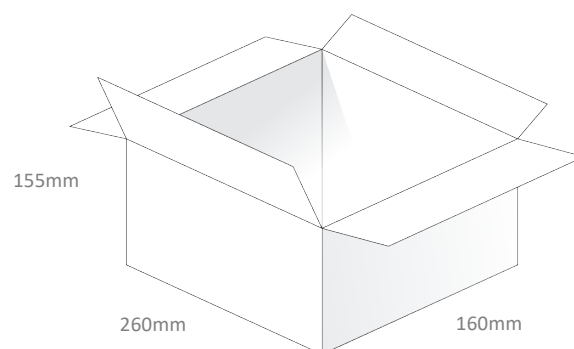

8. Application Note

8.1 Ground Plane Size and Orientation

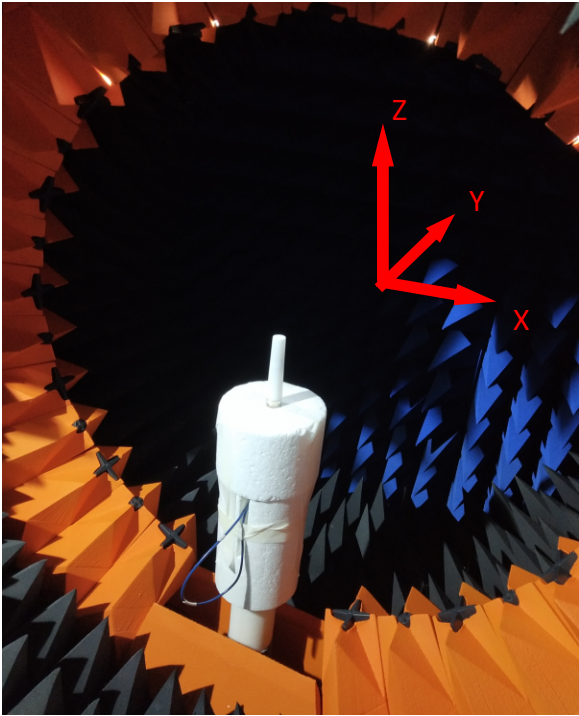

Free space - Antenna 90 degrees



30 x 30 cm GP – Antenna 90 degrees



150 x 90 mm GP – Antenna 90 degrees

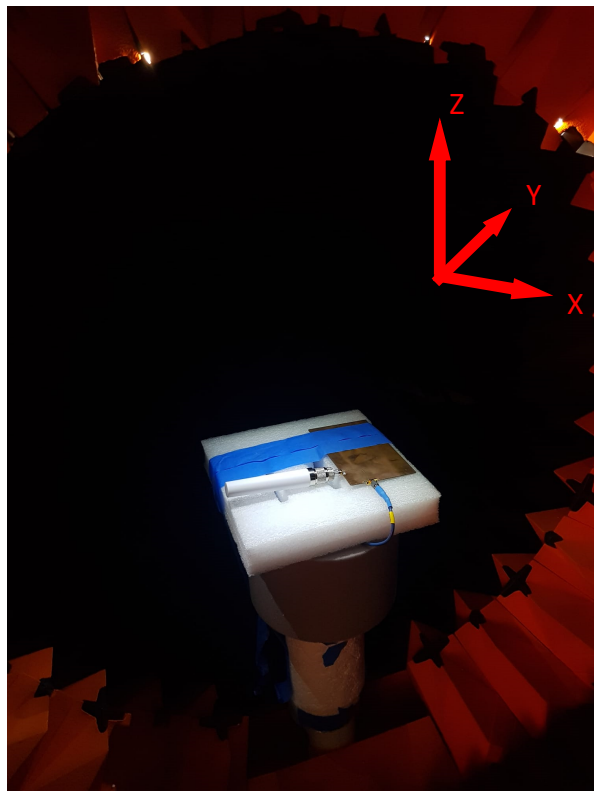

150 x 90 mm GP – Antenna Straight

8.2 Return Loss

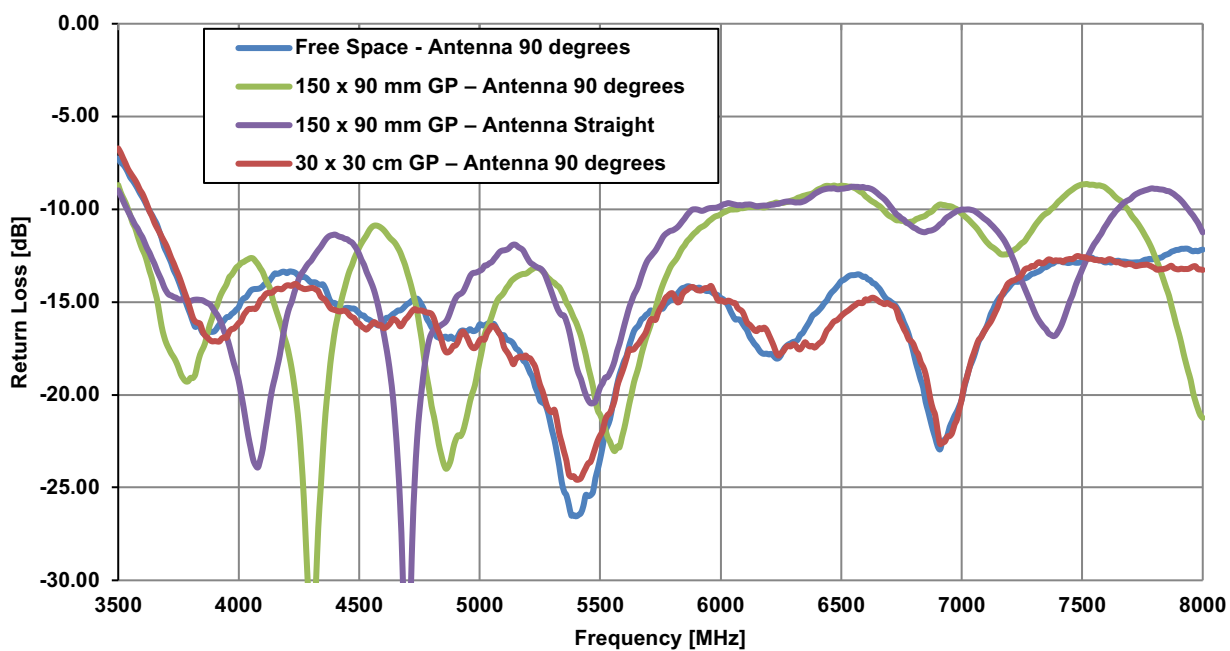

8.3 Efficiency

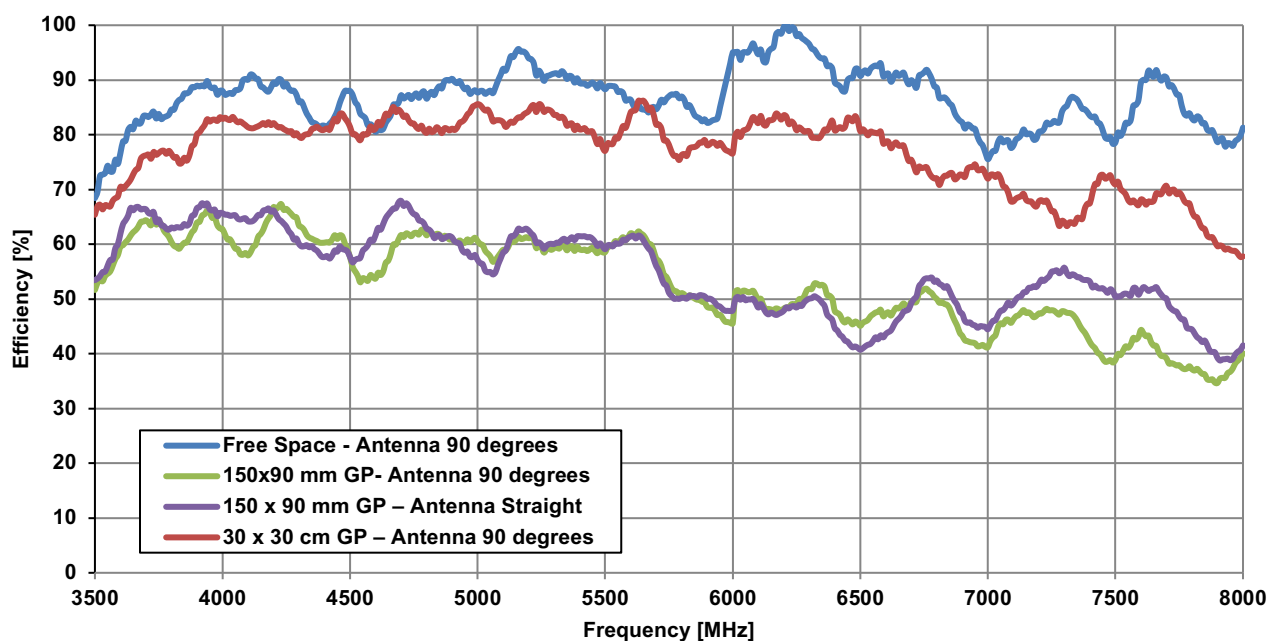

8.4 Average Gain

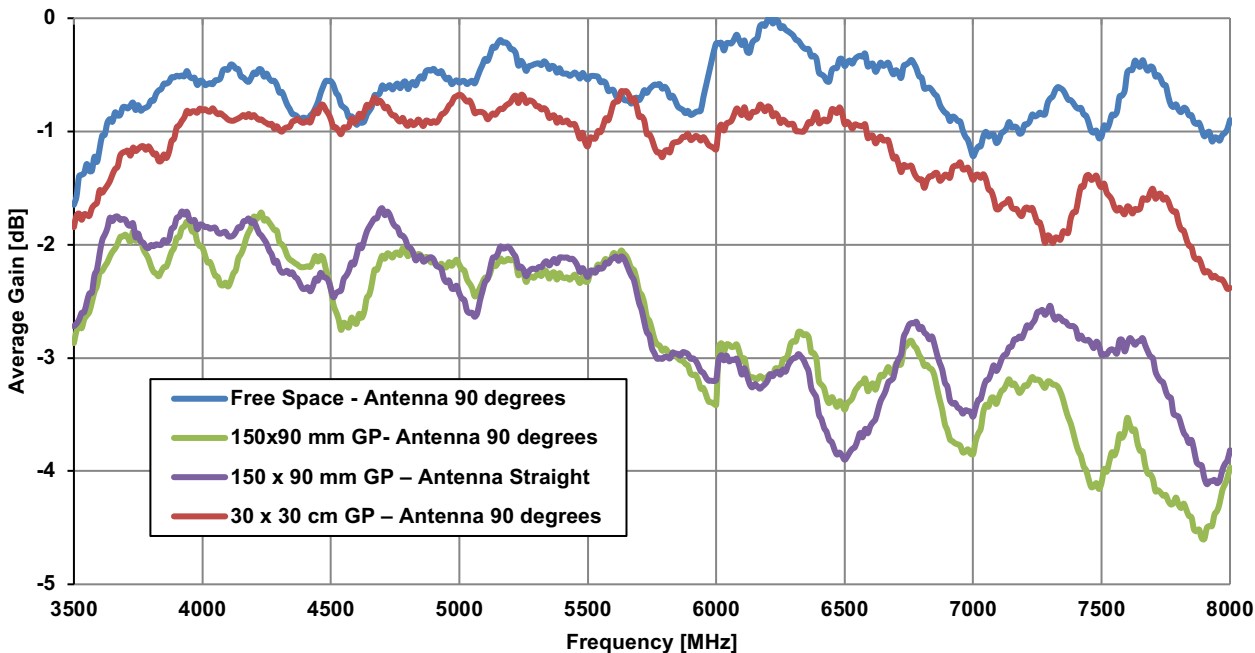

8.5 Peak Gain

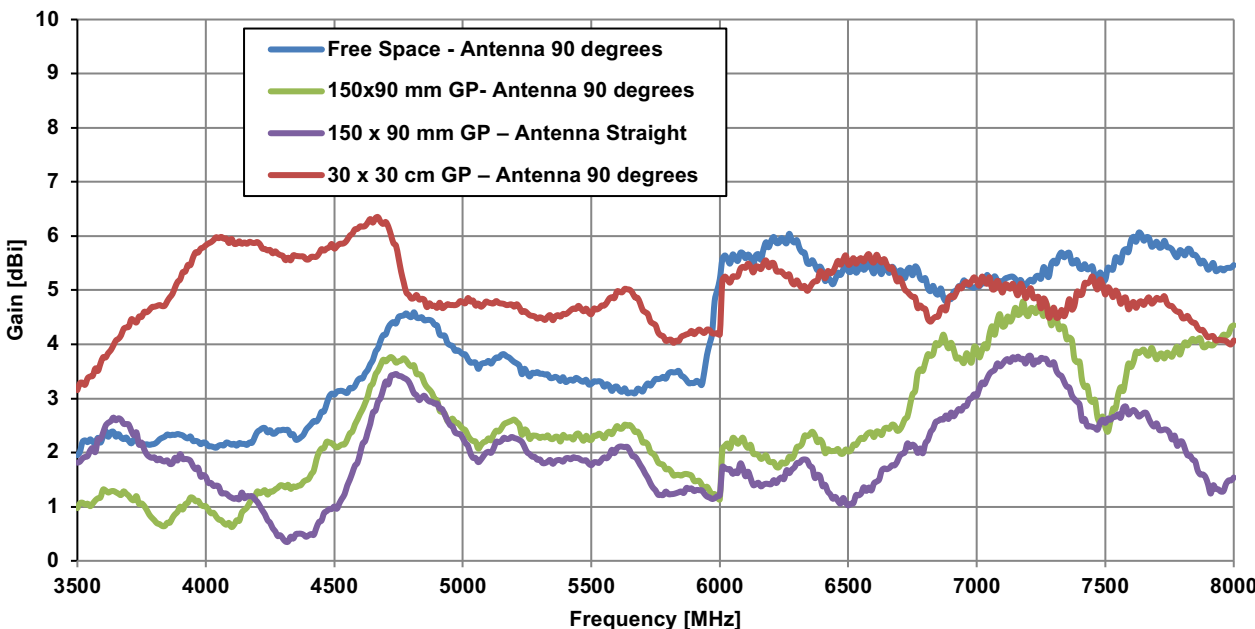

8.6 Group Delay – peak to peak variation over angle

30x30 cm GP - Antenna straight

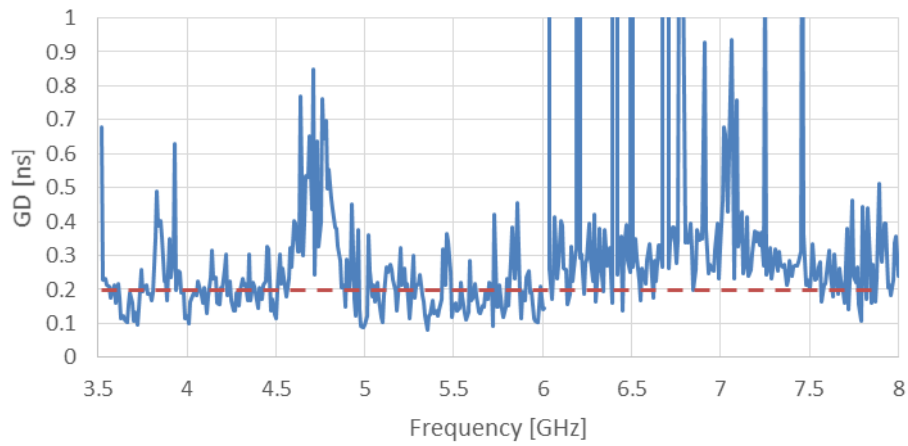

150 x 90 mm GP - antenna 90 degrees

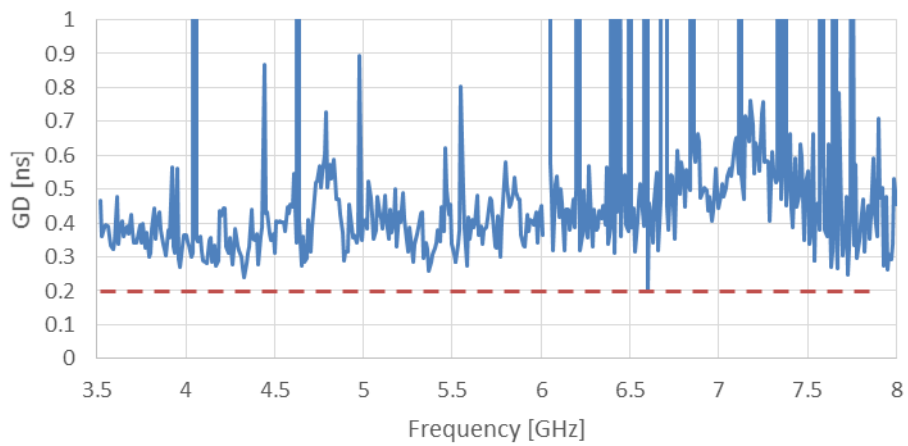

150 x 90 mm GP - antenna straight

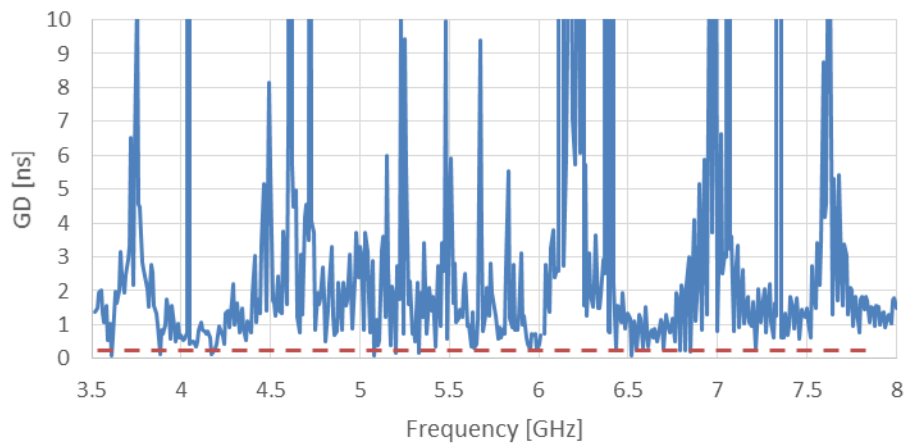

Changelog for the datasheet

SPE-20-8-032 – TU.60.3H31

Revision: A (Current Version)

Date:	2020-05-19
Notes:	Initial Datasheet Release
Author:	Jack Conroy

Previous Revisions



TAOGLAS®

www.taoglas.com

