



# TAOGLAS®



# Datasheet

## Magma X2

**Part No:**  
AA.175.301111

### Description:

MagmaX2 External Multi-Band GNSS Automotive Magnetic Mount Antenna

### Features:

Magnetic Mount

Covers:

- GPS/QZSS (L1/L2)
- Galileo (E1/E5b)
- GLONASS (G1/G2)
- BeiDou (B1/B2b)

Dimensions: 53\*50\*17mm

Excellent Out-Of-Band Rejection

Low Noise Figure & Low Axial Ratio

Cable: 3m of RG-174

Connector: SMA(M)

IP67 Waterproof Rating

RoHS & Reach Compliant

1. Introduction	3
2. Specifications	4
3. Antenna Characteristics	7
4. 2D Radiation Patterns	13
5. 3D Radiation Patterns	15
6. Field Test Results	16
7. Mechanical Drawing	17
8. Packaging	18
<hr/>	
Changelog	19

Taoglas makes no warranties based on the accuracy or completeness of the contents of this document and reserves the right to make changes to specifications and product descriptions at any time without notice. Taoglas reserves all rights to this document and the information contained herein.

Reproduction, use or disclosure to third parties without express permission is strictly prohibited.



# 1. Introduction



The Taoglas MagmaX2 AA.175, with Taoglas Sure Technology, is an embedded, active stacked patch, GPS antenna supporting both L1 and L2 bands. It is a high performance, economical solution for the highest accuracy centimeter-level tracking applications.

Typical applications include:

- UAVs and Robotics
- RTK
- Transportation
- Agriculture
- Autonomous Vehicles
- Navigation
- Marine

This compact antenna exhibits excellent radiation patterns on both L1 and L2 bands and with a low noise figure to preserve signal quality helps minimize time to first fix. It also features excellent out-of-band rejection to prevent out-of-band signals from overdriving or damaging its LNAs.

The AA.175 features very tight Phase Centre Offset (PSO) at just  $\pm 2\text{cm}$  at the L1 Band and  $\pm 5\text{cm}$  at the L2. The precision of antenna phase center directly affects the accuracy of GNSS positioning systems and can ensure that the accuracy of the receiver really is cm level.

This antenna has been tuned and tested on a 70 x 70 mm ground plane, working at GPS L1(1575.42MHz), GPS L2(1227.6MHz) and GLONASS L1(1602MHz) with a 2 stage LNA ensuring good signal strength. It can operate with an input voltage ranging from 1.8 to 5 volts.

Cables and connectors are customizable. Contact your regional Taoglas customer support team to request these services or additional support to integrate and test this antenna's performance in your device.

## 2. Specifications

GNSS Frequency Bands Covered						
GPS	L1	L2	L5			
	■	■	□			
GLONASS	G1	G2	G3			
	■	■	□			
Galileo	E1	E5a	E5b	E6		
	■	□	■	□		
BeiDou	B1	B2a	B2b	B3		
	■	□	■	□		
QZSS (Regional)	L1	L2C	L5	L6		
	■	■	□	□		
IRNSS (Regional)	L5					
	□					
SBAS	L1/E1/B1	L5/B2a/E5a	G1	G2	G3	
	■	□	■	□	□	

■ GNSS Frequency Bands Covered. □ GNSS Frequency Bands Not Covered.

\*SBAS systems: WASS(L1/L5), EGNOS(E1/E5a), SDCM(G1/G2/G3), SNAS(B1,B2a), GAGAN(L1/L5), QZSS(L1/L5), KAZZ(L1/L5).

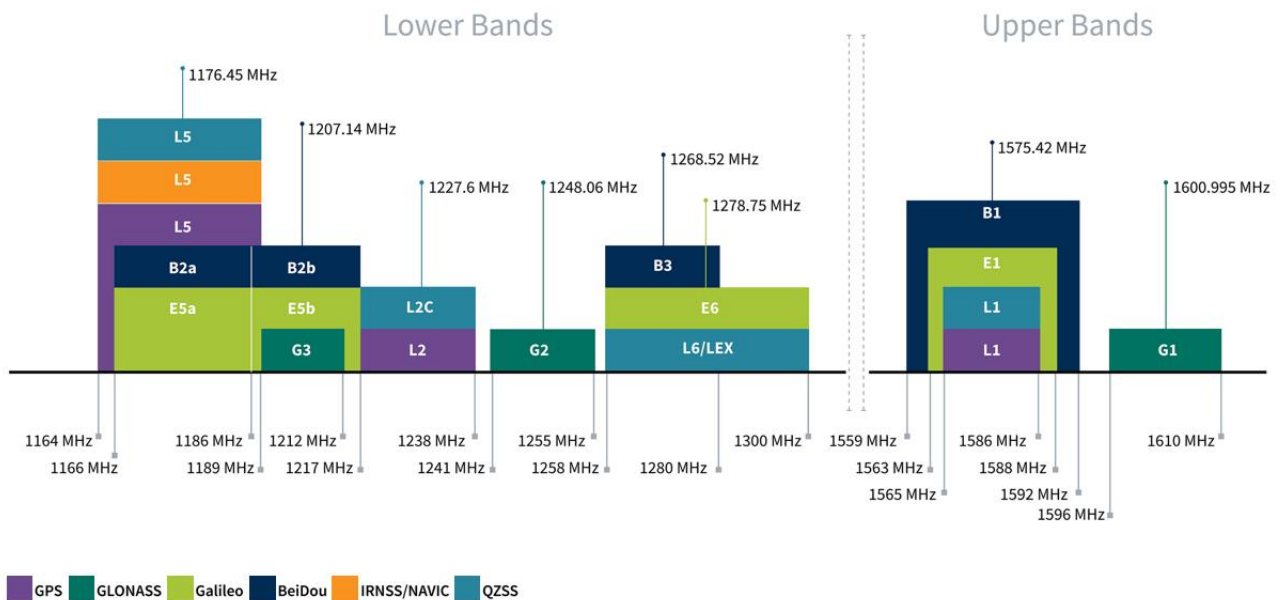

### GNSS Bands and Constellations

GNSS Antenna			
Band	GPS L2	GPS L1	GLONASS L1
Centre Frequency	1227.6MHz	1575.42MHz	1602MHz
VSWR	<2	<2	<2
Efficiency	85.5%	66%	67%
Peak Gain	3.78dBi	2.22dBi	2.05dBi
Group Delay	19	11	11
PCO (cm)	5	5	5
PCV (cm)	13.9	18	17
Axial Ratio at Zenith	3(typ)	n/a	n/a
Polarization	RHCP	Linear	
Impedance	50Ω		

LNA and Filter Electrical Properties			
Band	GPS L2	GPS L1	GLONASS L1
Centre Frequency	1227.6MHz±1.023MHz	1575.42MHz ±1.023MHz	1602MHz ±5MHz
Pin 1dB gain Compression Point	+2dBm Typ	+2dBm Typ	+2dBm Typ
Output Impedance	50 Ω		
Return Loss	<-10 dB		

LNA Gain, Power Consumption and Noise Figure			
	1.8V Min	3V Typ	5.5V
LNA Gain GPS L1	27dB	27dB	27dB
LNA Gain GLONASS L1	25dB	25dB	25dB
LNA Gain GPS L2	28dB	28dB	28dB
Noise Figure GPS L1	2.6dB	2.6dB	2.6dB
Noise Figure GLONASS L1	2.6dB	2.6dB	2.6dB
Noise Figure GPS L2	2.6dB	2.6dB	2.6dB
Current Consumption	16mA	16mA	16mA

Outer Band Attenuation		
100MHz~1180MHz	1280MHz~1520MHz	1700MHz~6000MHz
40dB	30dB	45dB

Mechanical	
Embedded Ceramic Patch Housing Dimensions	53*50*17mm
Housing Material	ABS
Cable	3M RG174 (fully customizable)
Connector	SMA(M) (fully customizable)
Waterproof	IP67
Weight	98g
Magnetic Pull Force	Pull horizontal max pull force(kgf): 0.52 Pull vertical max pull force(kgf): 0.48

Environmental	
Operation Temperature	-40°C ~ +85°C
Storage Temperature	-40°C ~ +90°C
Humidity	Non-condensing 40°C 95% RH

### 3. Antenna Characteristics

#### 3.1 Block Diagram (Active Antenna)

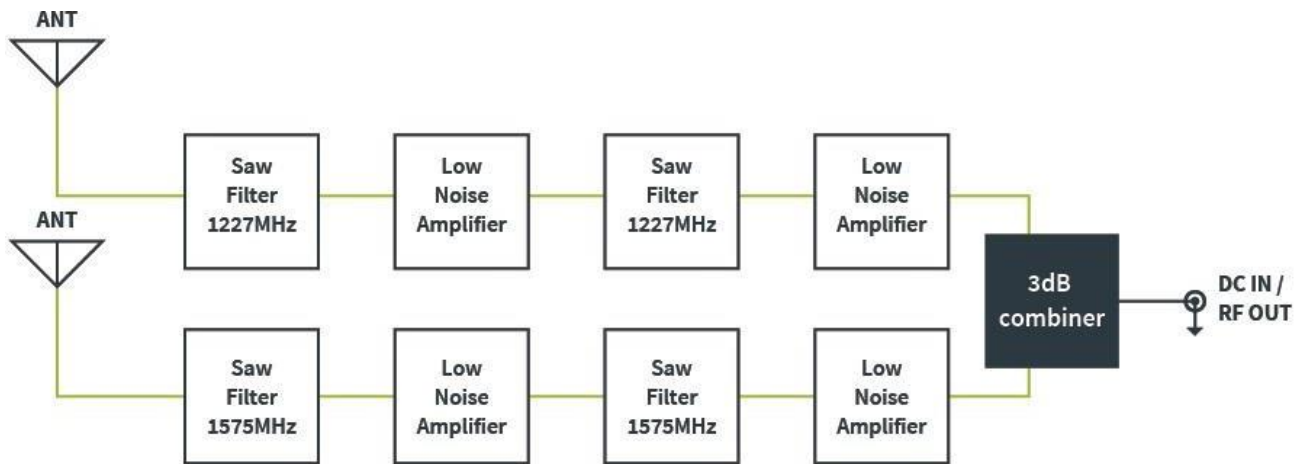

#### 3.2 VSWR (Passive antenna)

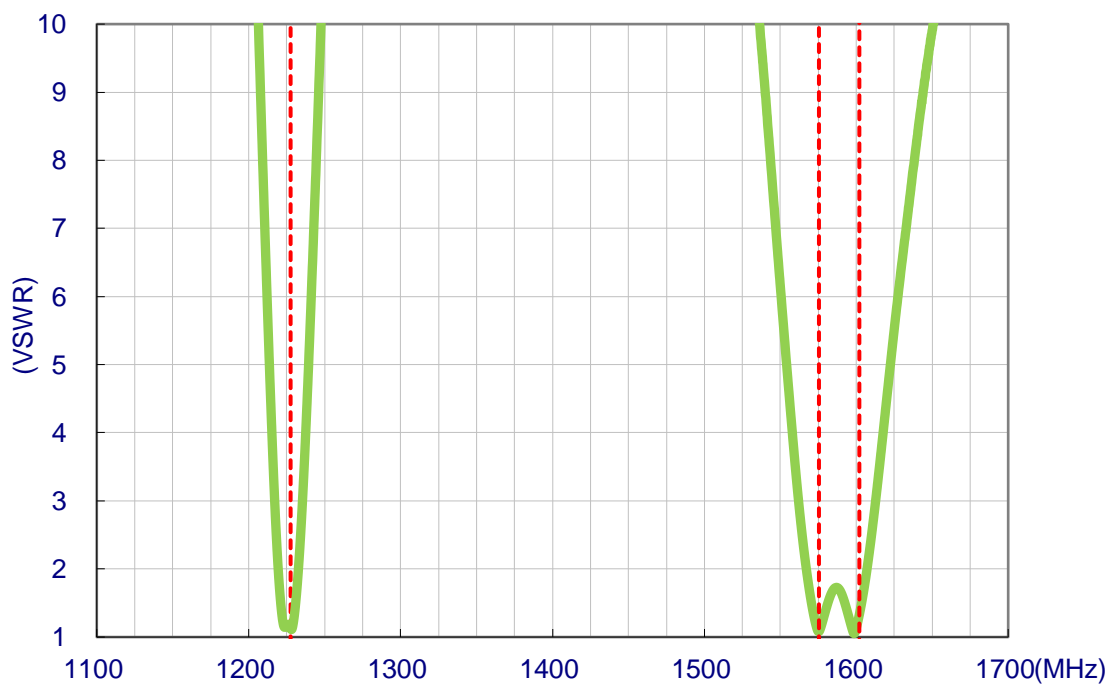

### 3.3 Efficiency (Passive Antenna)

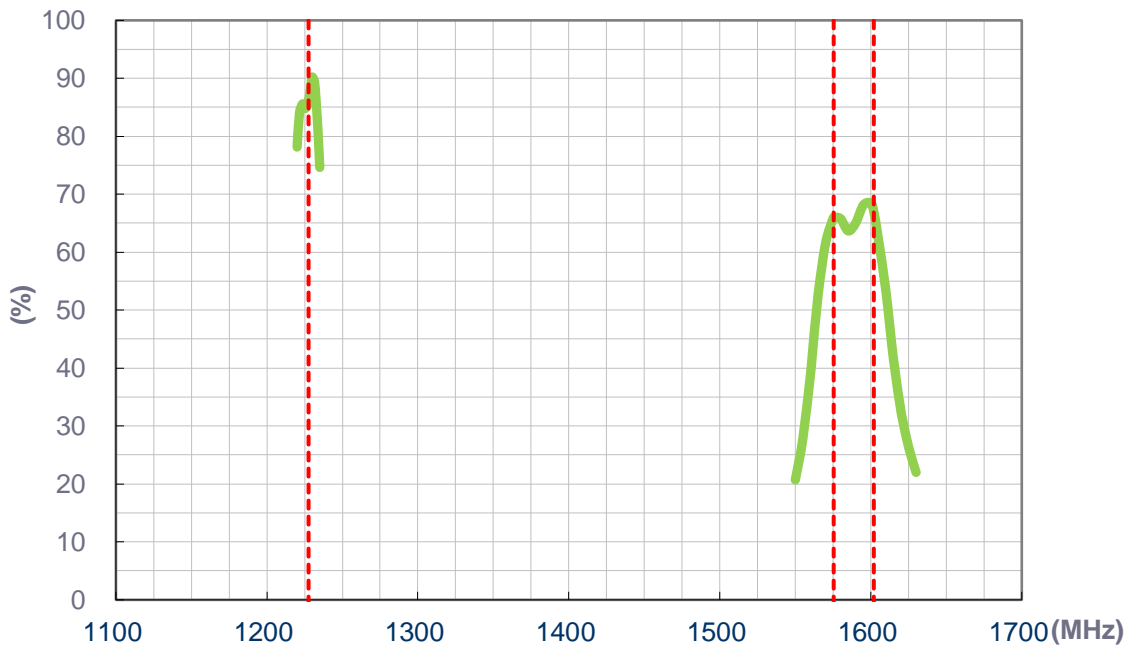

### 3.4 Average Gain (Passive Antenna)



### 3.5 Peak Gain (Passive Antenna)

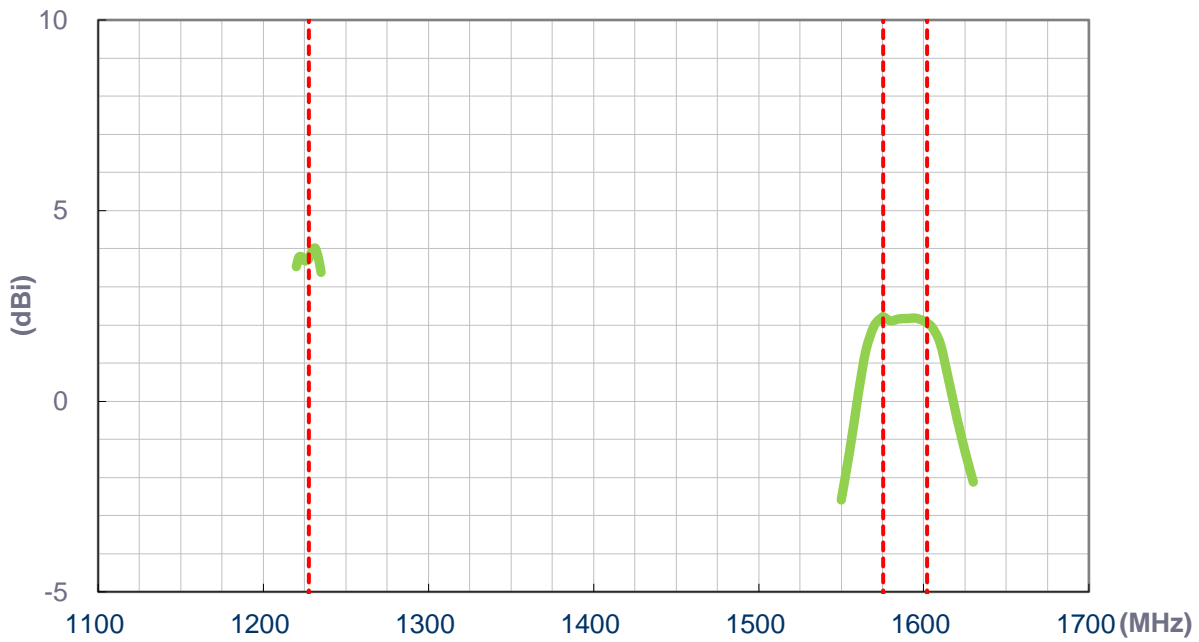

### 3.6 LNA Gain

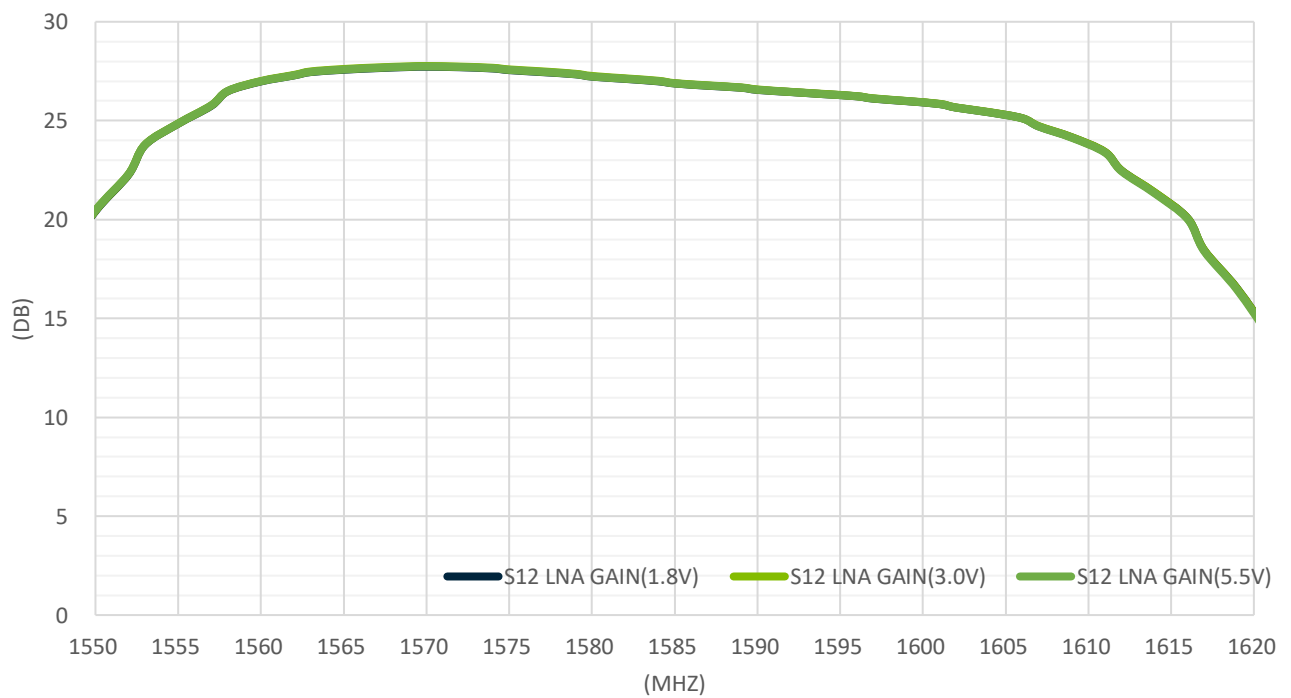

L1 1575MHz

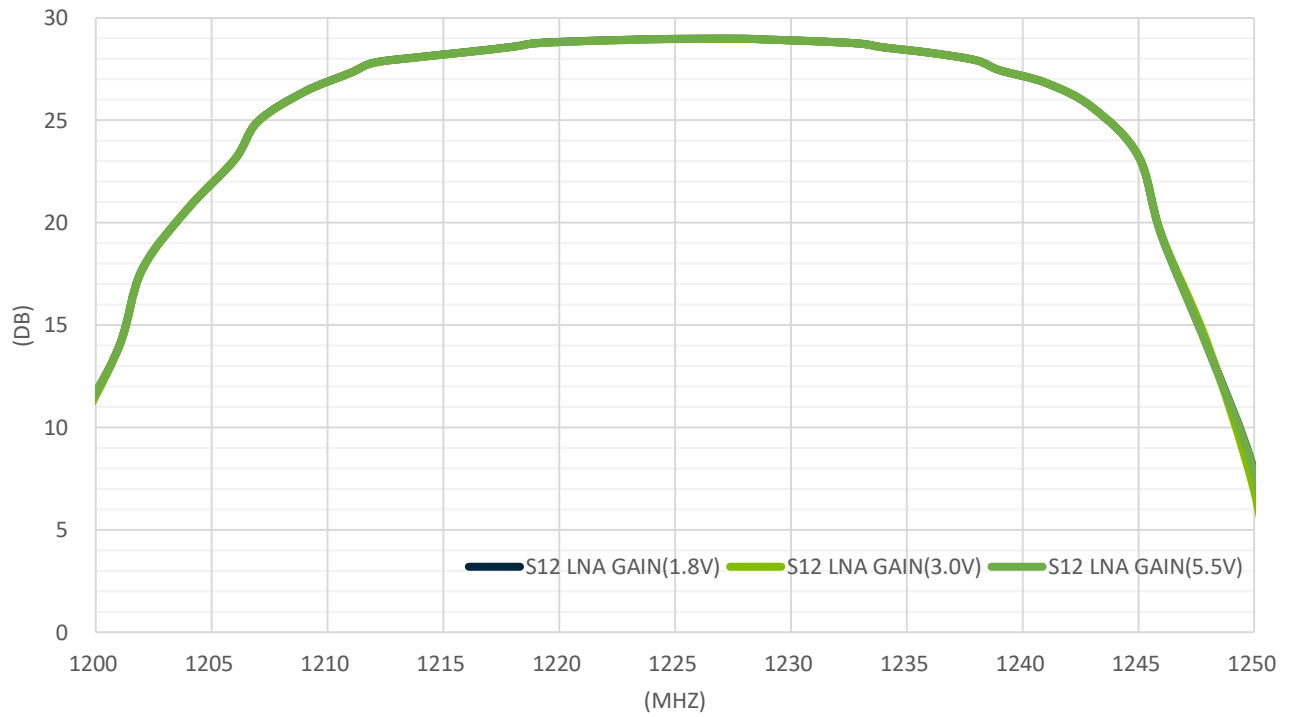

## L2 1227MHz

### 3.7 S12 Wide Band Plot

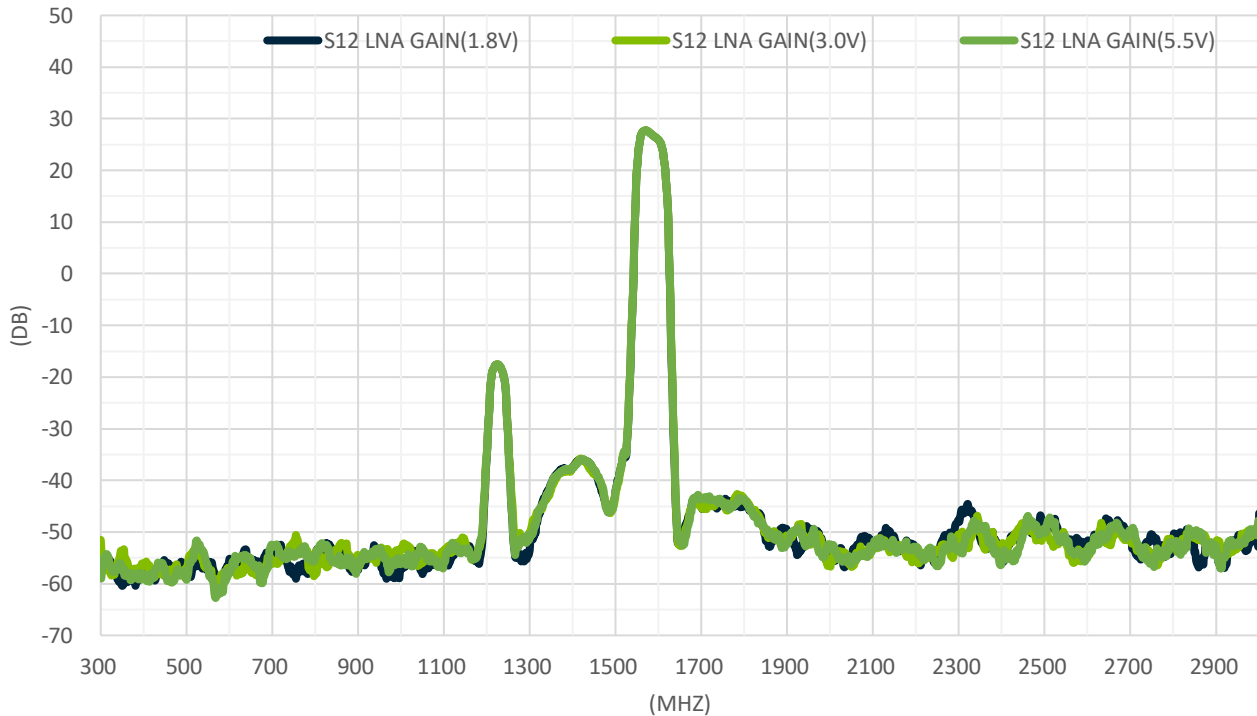

L1 1575MHz

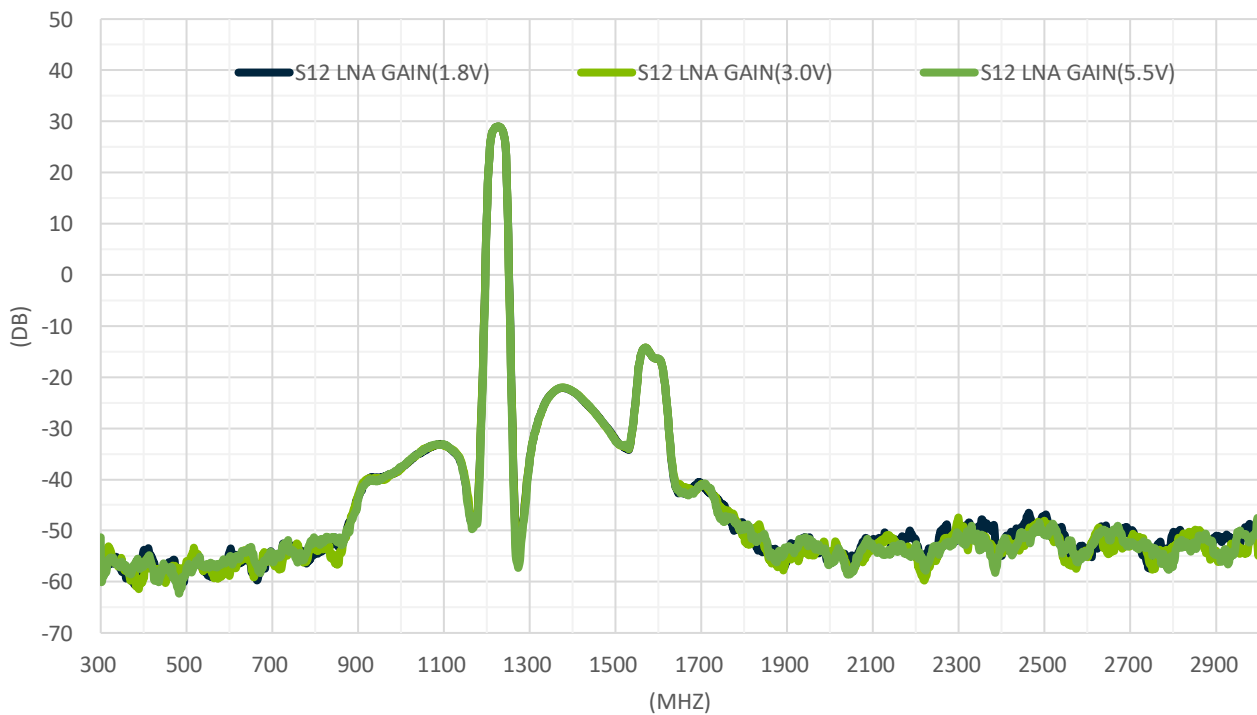

L2 1227MHz

3.8 Noise Figure

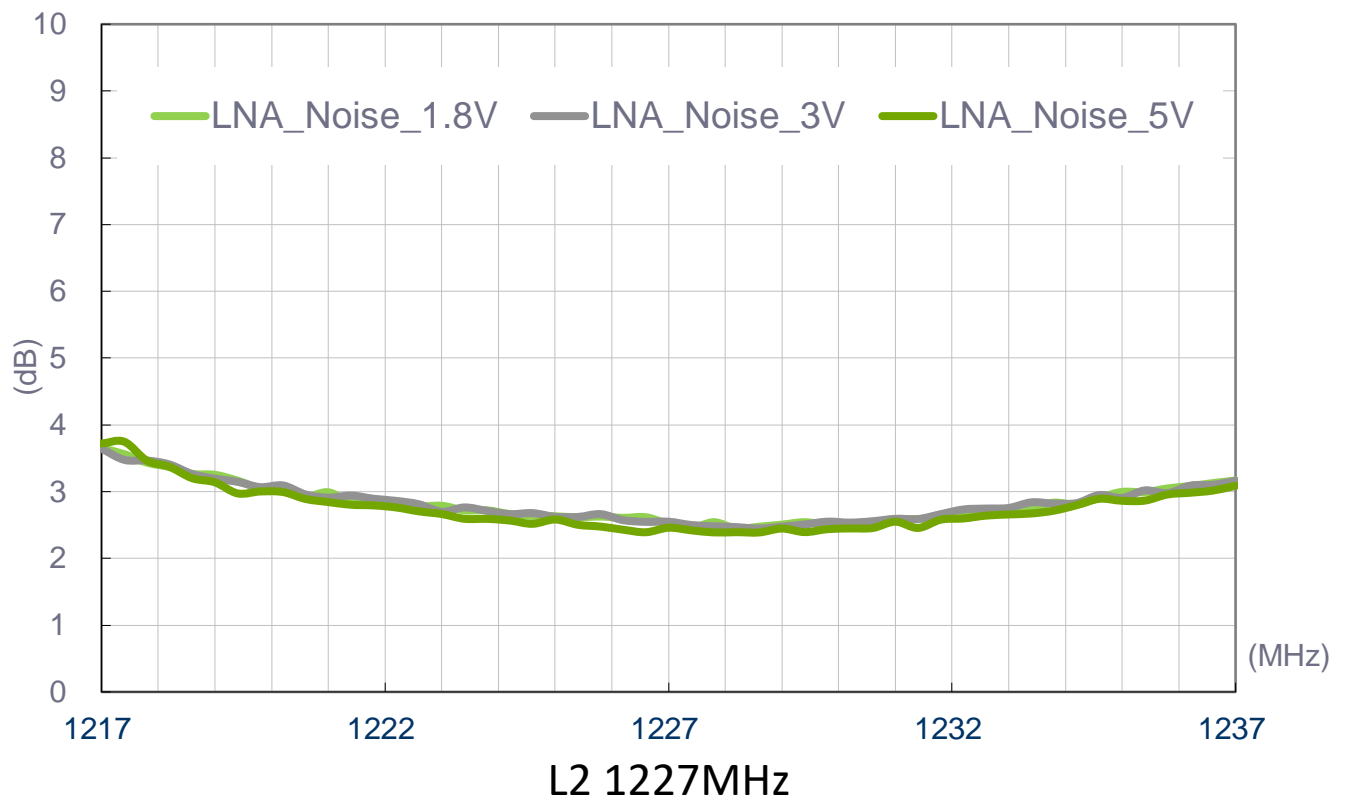
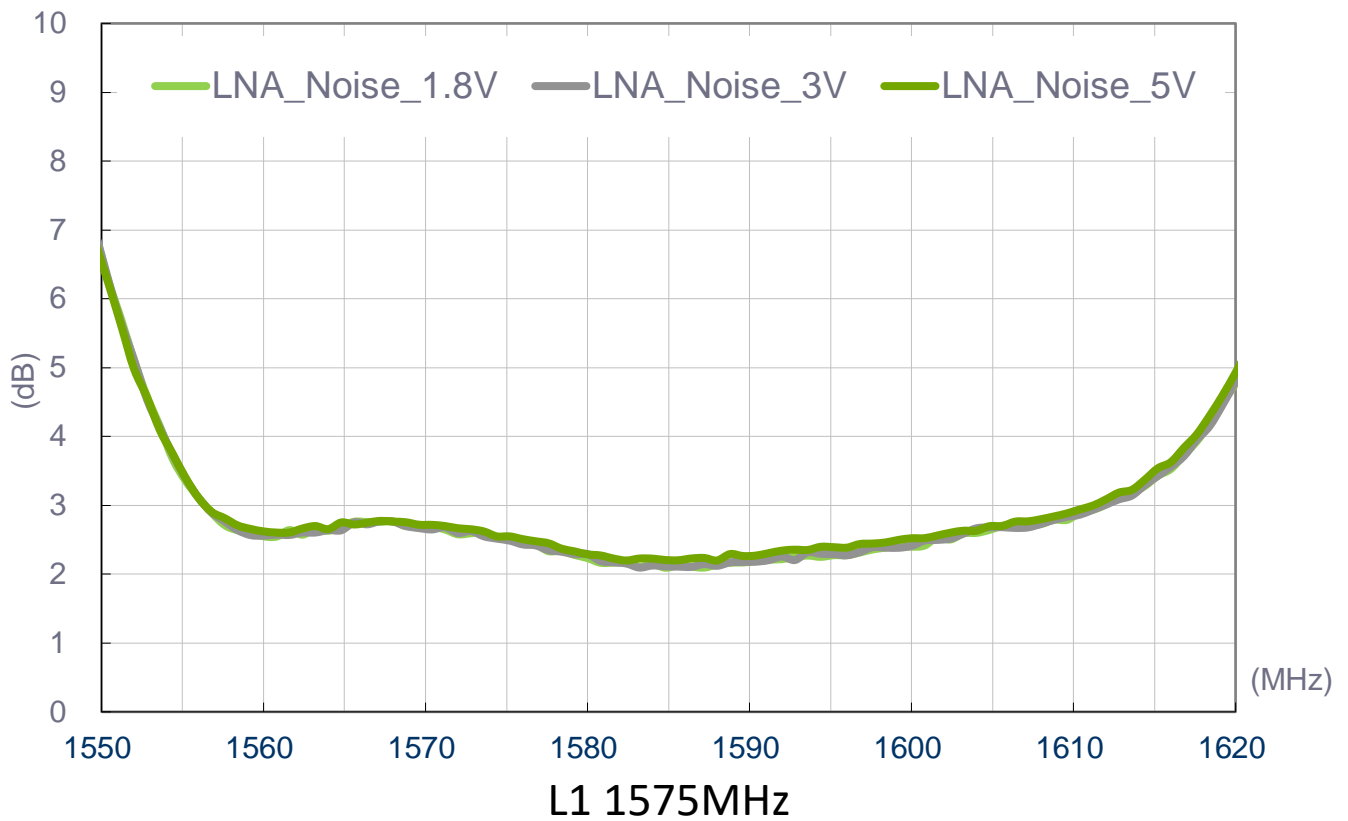

## 4. 2D Radiation Patterns

### 4.1 Test Setup

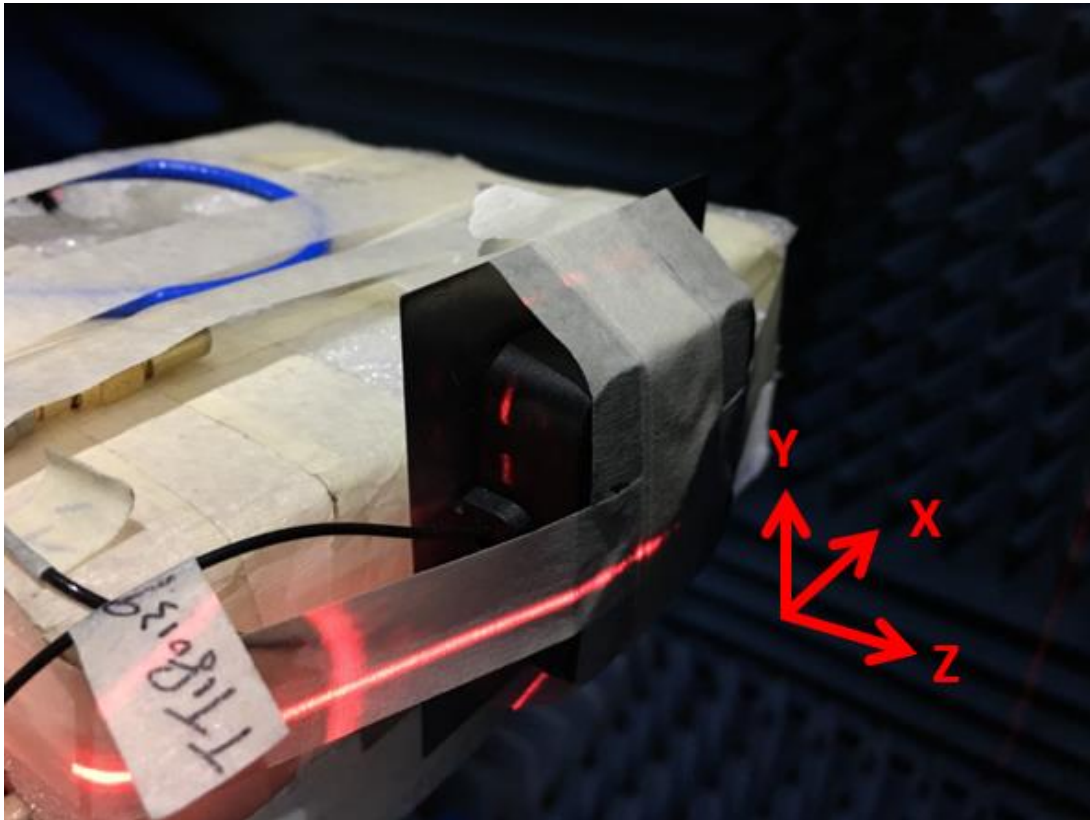

XY Plane

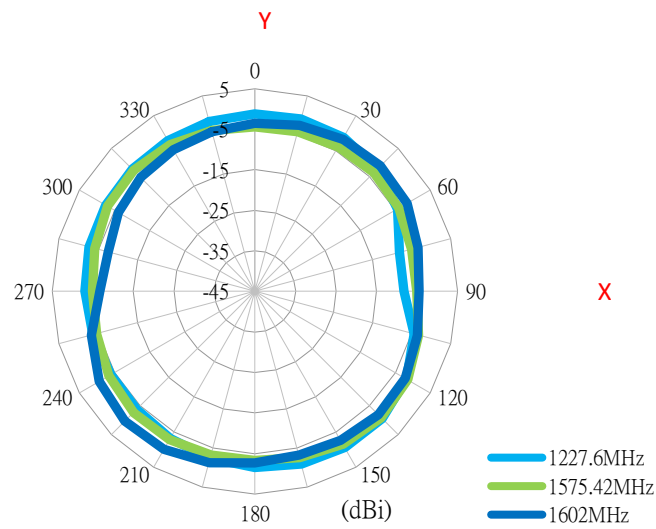

XZ Plane

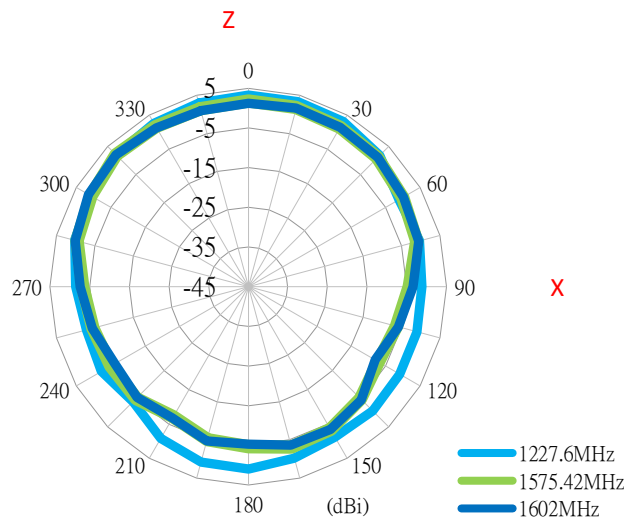

YZ Plane

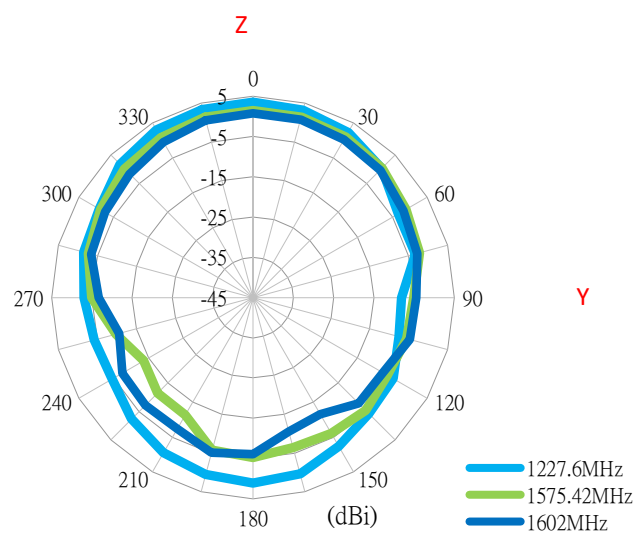

## 5. 3D Radiation Patterns

### 5.1 Free Space

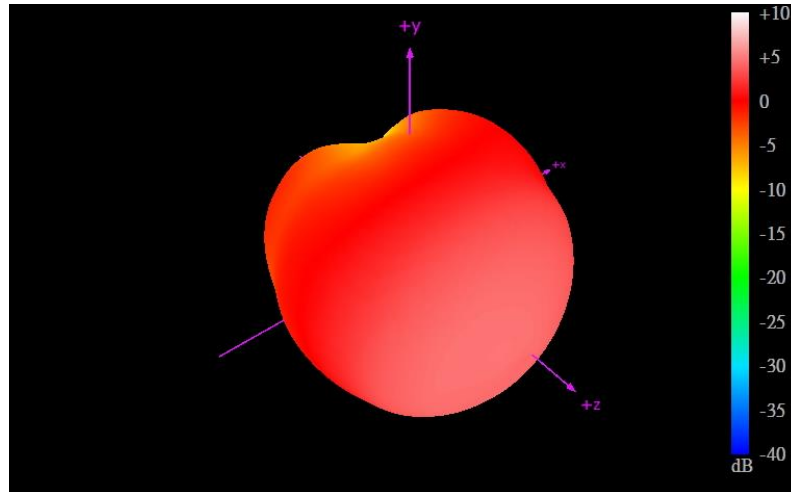

GPS L2\_1227.6MHz

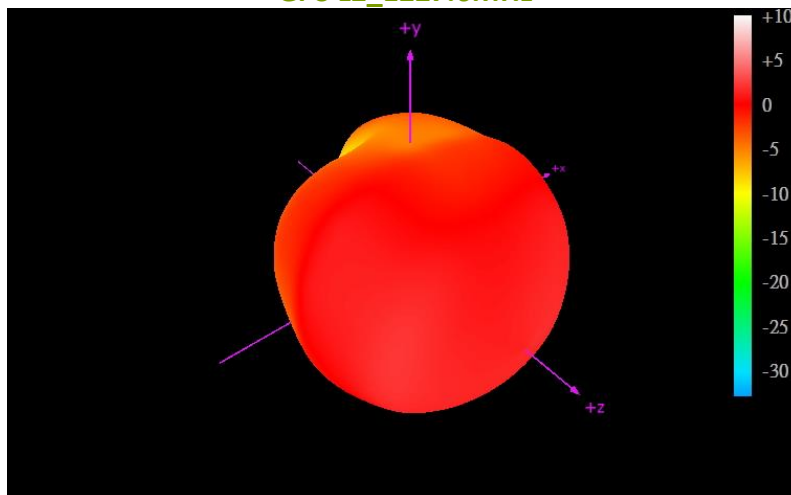

GPS L1\_1575.42MHz

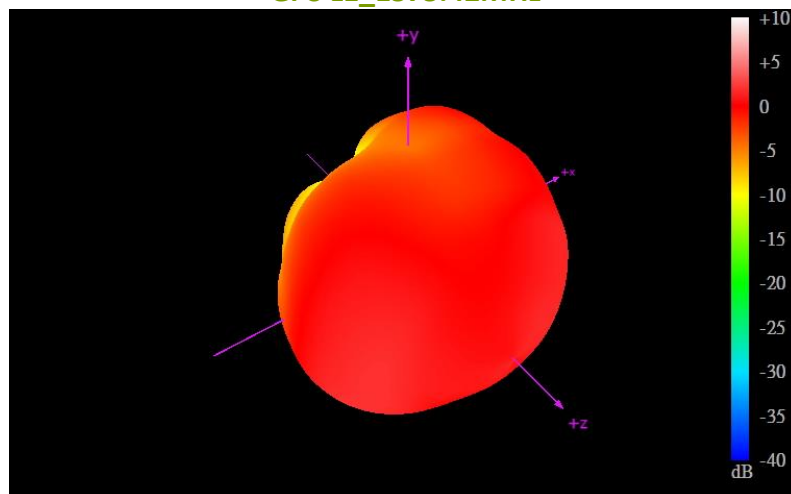

GLONASS L1\_1602MHz

## 6. Field Test Results

### 6.1 Rooftop test

In this section Taoglas will present the field test result for AA.175 antenna. The test was performed when the antenna was mounted on a static rooftop test set up in an open sky environment for at least **6 hours**.

Taoglas will show the field test results using the following receiver:

#### 1. U-blox ZED-F9P

##### Receiver features:

- Multi-band GNSS: 184-channel GPS L1C/A L2C, GLONASS: L1OF L2OF, Galileo: E1B/C E5b, BeiDou: B1I B2I, QZSS: L1C/A L2C
- Multi-band RTK with fast convergence times and reliable performance
- Nav. update rate RTK up to 20 Hz
- Position accuracy = RTK 0.01 m + 1 ppm CEP

Positioning Accuracy Table (2D Accuracy)					
Test Condition	Correction Service	CEP (50%)	DRMS (68%)	2DRMS (95-98.2%)	TTF (sec)
Free Space	RTK DISABLED	71.9 cm	86.35 cm	172.7 cm	22
	RTK ENABLED	0.86 cm	1.03 cm	2.07 cm	22
30x30 cm Ground Plane	RTK DISABLED	62.43 cm	78.25 cm	156.5 cm	21
	RTK ENABLED	0.74 cm	0.9 cm	1.79 cm	21

RTK Availability  
Free space

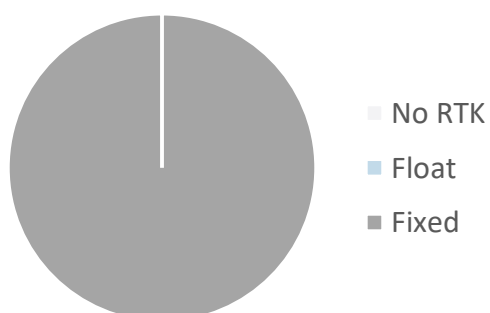

RTK Availability  
30x30 cm ground plane

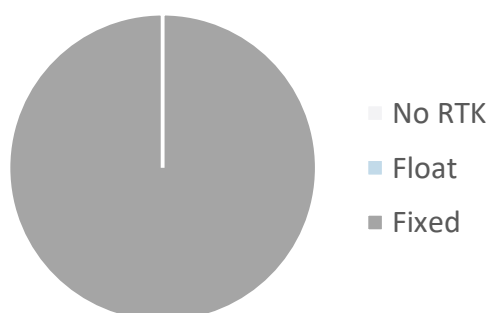

# 7. Mechanical Drawing (Units: mm)

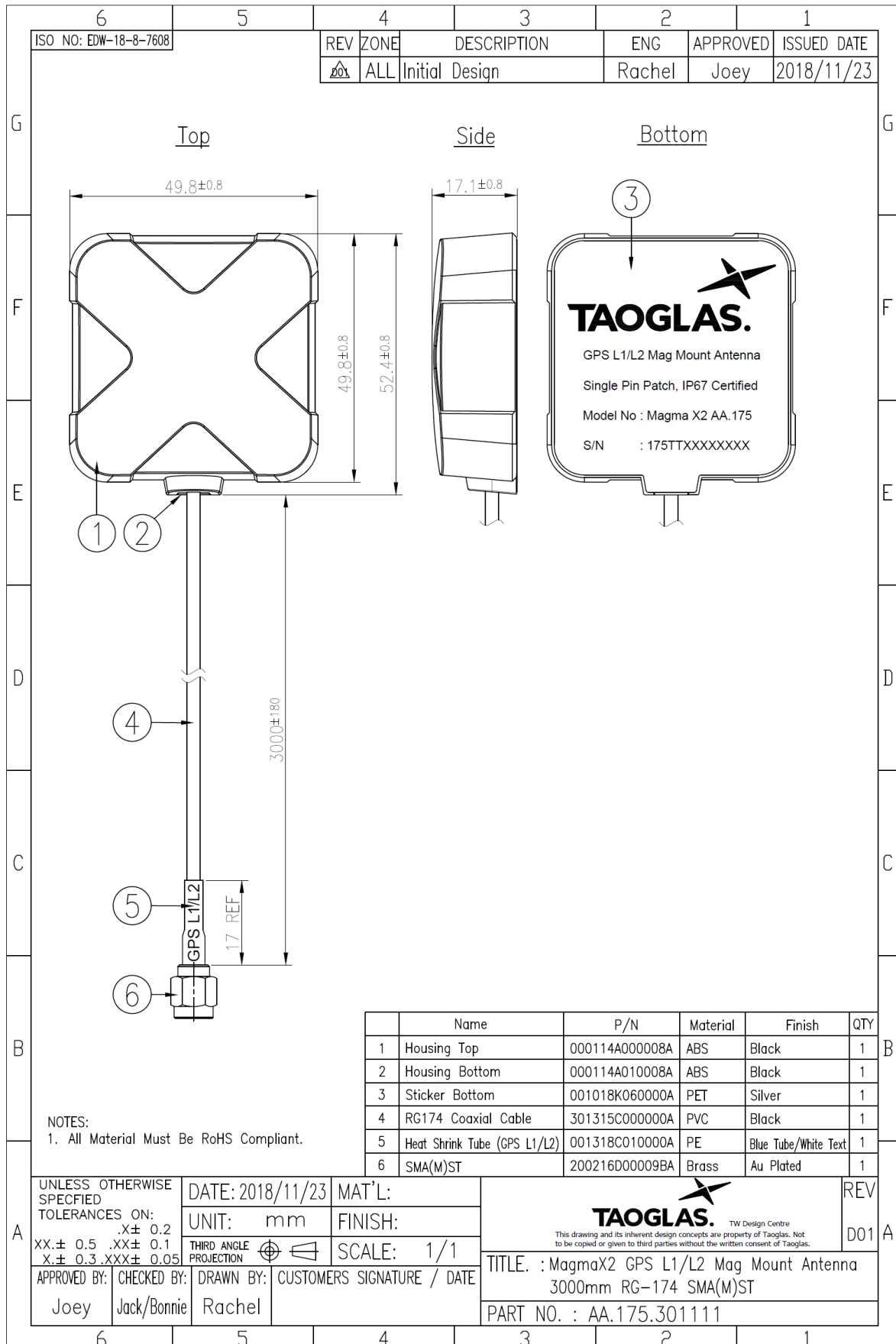

## 8. Packaging

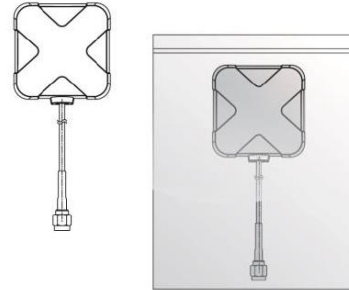

1 pcs AA.175.301111 per PE Bag  
 SPQ: 10pcs/PE Bag

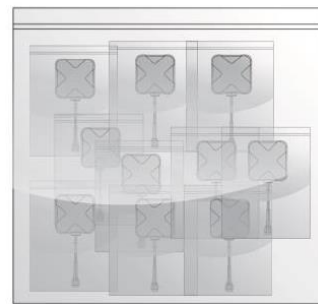

100pcs  
 10 Large PE Bags in one carton  
 Carton Dimensions-370\*370\*300mm

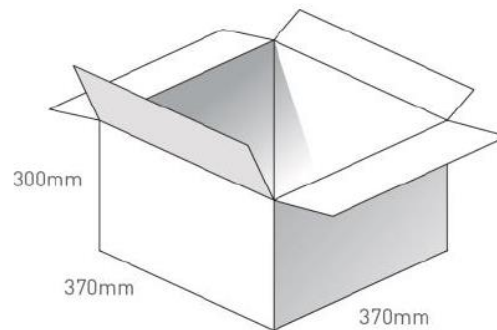

Changelog for the datasheet

**SPE-19-8-066 – AA.175.301111**

Revision: B (Original First Release)	
Date:	2020-06-02
Notes:	Field test added
Author:	Victor Pinazo

**Previous Revisions**

Revision: A (Original First Release)	
Date:	2019-05-23
Notes:	Initial Datasheet Release
Author:	Jack Conroy

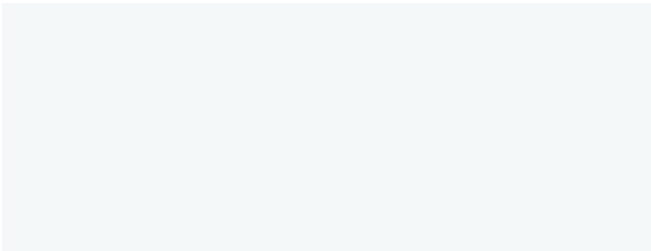
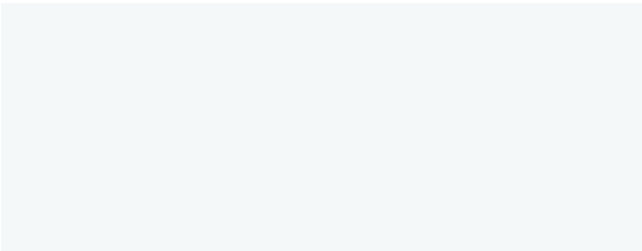
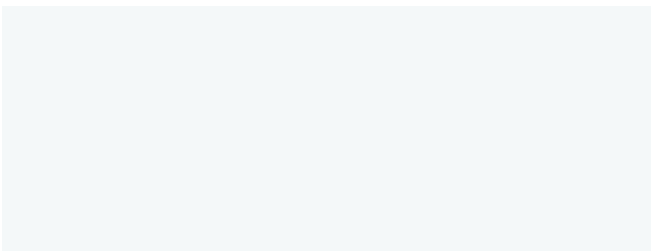
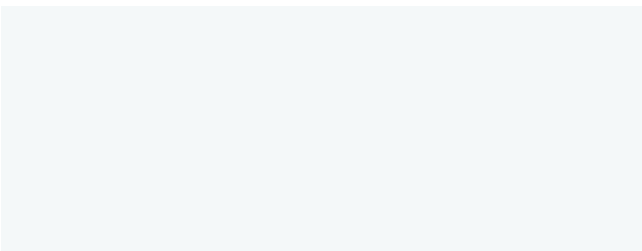
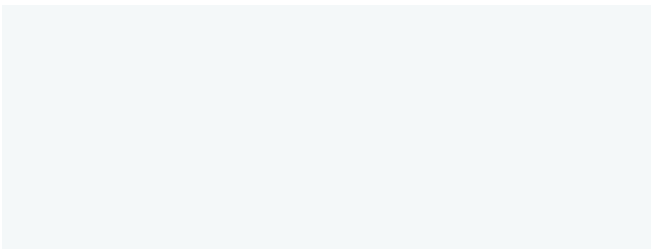
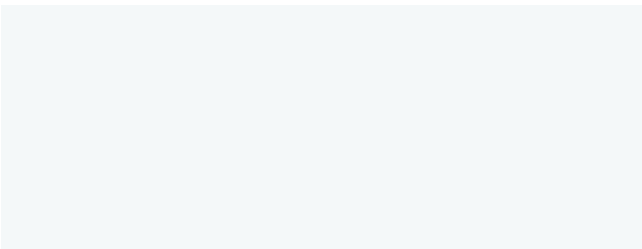
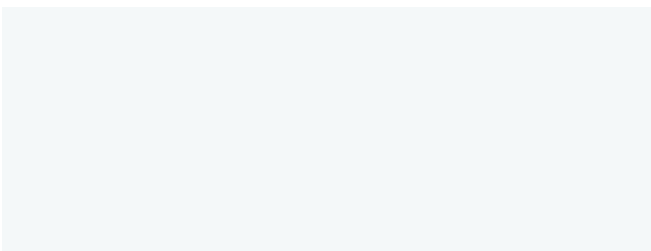
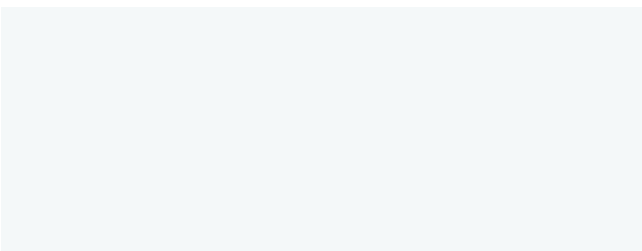
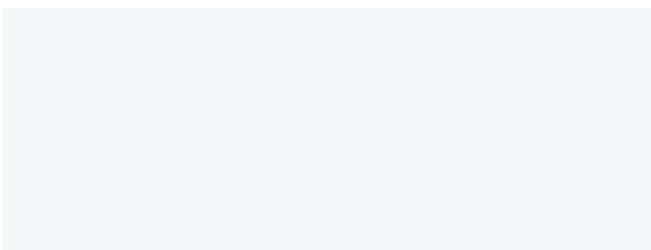



**TAOGLAS**®

[www.taoglas.com](http://www.taoglas.com)

