

## **Fieldbus Direct**

Extremely compact and space-saving

**FESTO**

The ideal fieldbus solution  
for confined fitting spaces.

Fieldbus  
Direct

**Info 201 →→**

## Fieldbus Direct and valve terminals from Festo – the flexible space-saving system

### **Convincingly direct: the overall concept**

A world class product with an impressive size to flow ratio. The Fieldbus Direct valve terminals CPV, CPV-SC and CPA-SC can be installed right where they're needed, for example on a robot arm. Direct proximity to the actuator ensures short switching times. The CDVI with Fieldbus Direct offers an impressive corrosion-resistant and easy-to-clean surface.

### **Convincingly direct: the electrical concept**

The first task involved in designing a system is the control concept. The fieldbus system is extremely well defined. Looking for the right pneumatic control concept? No problem with the CPV, CPV-SC, CPA-SC and the CDVI valve terminal from Festo. Direct actuation makes it compatible with all of the most commonly used fieldbus protocols: Profibus DP, Interbus, DeviceNet, CANopen, AS-interface®, Beckhoff, ABB – including Festo plug & work®.

### **Convincingly direct: the pneumatic concept**

Valve terminals designed by the inventor of the valve terminal merely have to convince through the sum of their parts. With valve functions up to eight 5/2-way valves and up to sixteen 3/2-way valves and flow rates from 150 to 1,600 l/min, the modular, versatile, compact and sturdy Compact Performance terminals have

it all. Need vacuum technology? The CPV vacuum valve slice gives you vacuum technology right where it's needed. An optional pneumatic multiple connector plate allows pneumatic and electrical work to be carried out on the valve terminal at any time. The CDVI really comes into its own in corrosive environments.

### **Fieldbus Direct: maximum performance in the minimum of space**

"Fieldbus Direct" valve terminals increase the productivity of decentralised system concepts. IP65 and direct fieldbus integration allows the Compact Performance valve terminal CPV, CPV-SC and CPA-SC to be installed closer to the actuator. They offer virtually unlimited flexibility thanks to versatile pneumatic connection options. Fieldbus Direct is the most compact way of connecting valves to a fieldbus.

### **Optional: the CP string extension**

The optional string extension allows additional valve terminals and I/O modules (161, 160) to be connected to the fieldbus nodes of the Fieldbus Direct valve terminals. A CP string of the CP installation system is integrated in the fieldbus node as an extension. The CP string extensions range from 0.5 to 10 metres in length, which means that the modules with selectable connection technology can be mounted directly on-site (IP65/IP67).

Fieldbus Direct – extremely compact and space-saving!



Decentralised installation ...

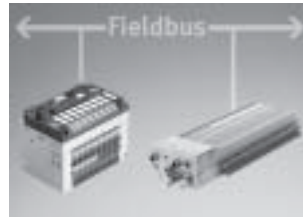

decentralised networking ...



for small I/O units

Drive-adjacent for short cycle times.

Valve terminals directly at the fieldbus and expandable by max. 2 modules.

Cost-effective solution for the connection of a small number of input/outputs at the fieldbus, incl. extension diagnostic options for each slave.

Fieldbus Direct: one system for a number of tasks with an even greater number of advantages.

	Advantages for designers	Advantages for purchasers	Advantages for commissioning and maintenance
<b>1. Direct connection for fieldbus protocols</b>	<ul style="list-style-type: none"> <li>■ Easy integration in existing control systems</li> <li>■ Direct fieldbus connection of a small number of pneumatic drives</li> <li>■ Easy to switch between a number of fieldbus protocols (CPV)</li> </ul>	<ul style="list-style-type: none"> <li>■ Reduced costs thanks to single sourcing</li> <li>■ Optimised product selection and warehousing</li> <li>■ Reliable ordering thanks to FACE software configurator with plausibility check</li> </ul>	<ul style="list-style-type: none"> <li>■ Easy to expand</li> <li>■ Fast and reliable switching of modules</li> <li>■ Extensive diagnostic options</li> <li>■ Condition monitoring</li> </ul>
<b>2. Proven basic pneumatic concept</b>	<ul style="list-style-type: none"> <li>■ Reduced installation space thanks to maximum performance in confined spaces</li> <li>■ Terminal installed directly where it's needed</li> <li>■ Flexible adaptation to the automation task</li> <li>■ Installation-saving solutions save time</li> </ul>	<ul style="list-style-type: none"> <li>■ Pneumatically innovative and proven technology reduces follow-up costs</li> <li>■ Reduced warehousing costs</li> <li>■ High reliability of supply</li> <li>■ Fully pre-assembled and tested units</li> <li>■ Low operating costs</li> </ul>	<ul style="list-style-type: none"> <li>■ Reduced costs thanks to fewer different parts</li> <li>■ Simple, step-by-step installation and commissioning</li> </ul>
<b>3. Access to a proven basic product</b>	<ul style="list-style-type: none"> <li>■ Comprehensive technical documentation for designers (parts list, dimensional drawings, etc.)</li> <li>■ Greater operational reliability and longer service life</li> </ul>	<ul style="list-style-type: none"> <li>■ High machine availability</li> <li>■ High productivity</li> <li>■ Simple logistics</li> </ul>	<ul style="list-style-type: none"> <li>■ Easy advance commissioning</li> <li>■ Competent support and comprehensive product documentation</li> <li>■ Integrated diagnostic concept reduces system downtimes</li> </ul>

# Fieldbus Direct

Key features

FESTO

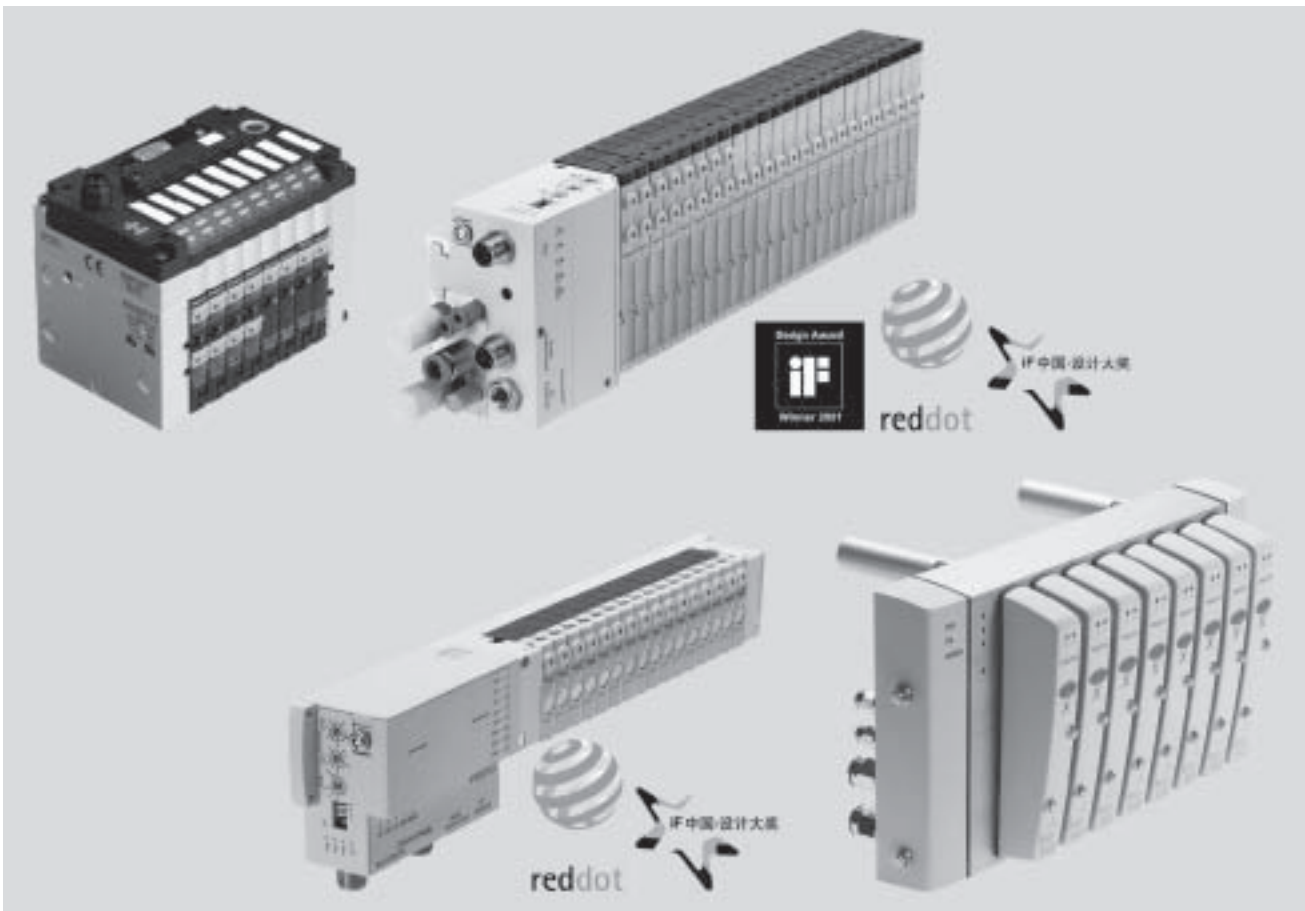

## The system

- Extremely compact and space-saving design
- Low-cost solution for the connection of a small number of valves to a fieldbus
- Extremely safe, degree of protection to IP69k depending on the series

The Fieldbus Direct system contains four valve terminal series.

- CPV (type 10)
- CPVSC1 (type 80)
- CPASC1 (type 82)
- CDVI (type 15)

The Fieldbus Direct product range is the most compact way of connecting valves to a fieldbus. The fieldbus node is directly integrated in the electrical interface of the valve terminal and therefore takes up only a minimal amount of space.

Fieldbus Direct is a system for the connection of one valve terminal to nine different fieldbus standards. The most important systems including Profibus, Interbus, DeviceNet and CANopen are supported.

The CP string extension option allows the functions and components of the CP installation system to be used.

The optional string extension allows an additional valve terminal and I/O modules to be connected to the Fieldbus Direct fieldbus node.

The I/O modules and cables for the CP string extension are ordered using the order code for the CP installation system.

The max. length of the CP string extension is 10 metres, which means that the extension modules can be mounted directly on-site. All of the required electrical signals are transmitted via the CP cable, which in turn means that no further installation is needed on the extension module.

# Fieldbus Direct

Key features

## Switch module for CPV Direct

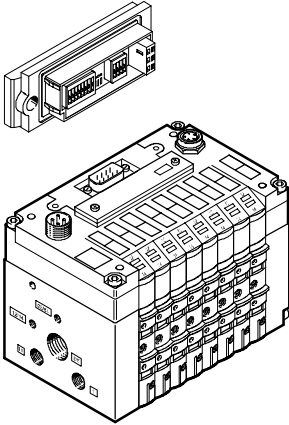

The bus parameters and the device configuration of CPV Direct are set using the removable switch module. The integrated DIL switches are also

easy to set and check, even if the mounting position is difficult to access.

## CP string extension

The optional string extension allows an additional valve terminal and I/O modules to be connected to the Fieldbus Direct fieldbus nodes. A CP string of the CP installation system is integrated in the fieldbus node as an extension. Different input and output modules as well as CPV and CPA valve terminals can be connected.

The max. length of the CP string extension is 10 metres, which means that the extension modules can be mounted directly on-site. All of the required electrical signals are transmitted via the CP cable, which in turn means that no further installation is needed on the extension module.

The CP string interface offers:

- 16 input signals
- 16 output signals for output modules 24 V DC or solenoid coils
- Logic and sensor supply for the output modules
- Load voltage supply for the valve terminals
- Logic supply for the output module

## CPV Direct with fieldbus node

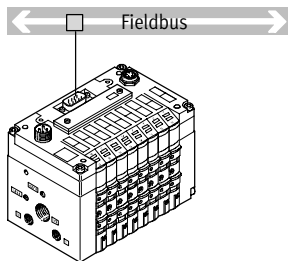

- 8 valve slices
- 16 solenoid coils
- 16 valves with 3/2-way valves

## CPV Direct with input module 24 V DC for detecting the cylinder end positions

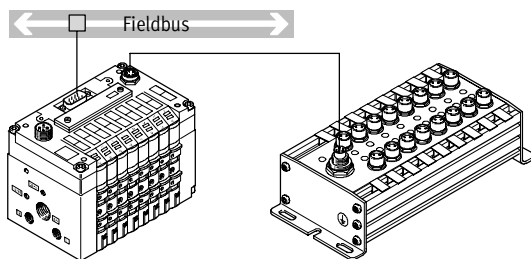

- 8 valve slices
- 16 inputs M8 or M12, each with sensor supply

# Fieldbus Direct

Overview of examples

## Connection options

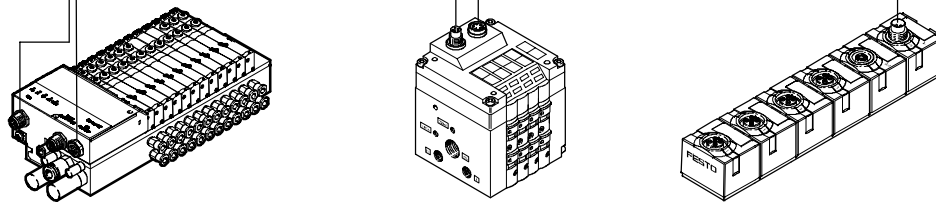

CPASC1 valve terminals with fieldbus interfaces can be equipped with 4 to 24 valve positions and 4 to 32 solenoid coils.

Variants

- DeviceNet connection
- 4 to 32 solenoid coils

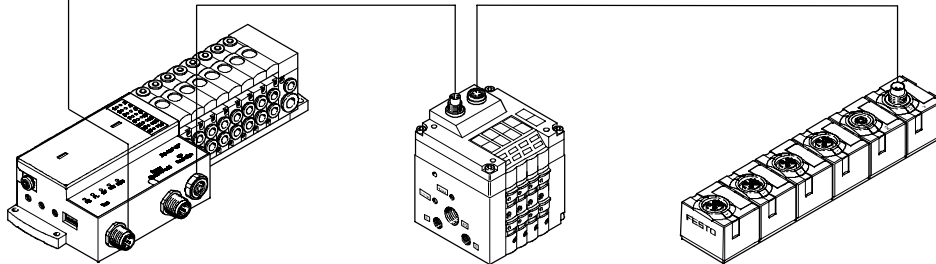
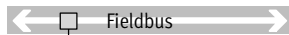

CPVSC1 valve terminals with fieldbus interfaces can be equipped with 4 to 16 valve positions and 4 to 16 solenoid coils.

Variants

- DeviceNet connection
- 4 to 16 solenoid coils

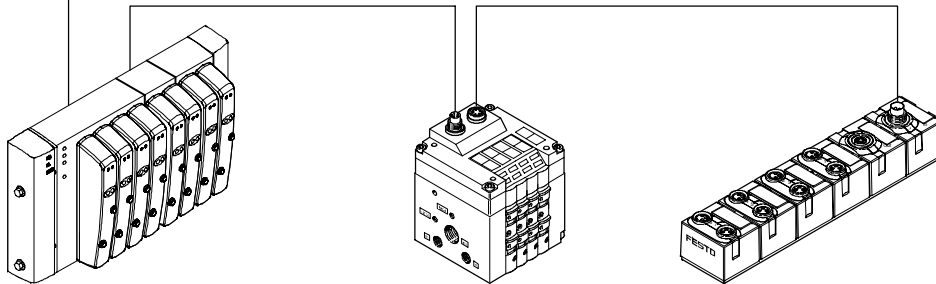
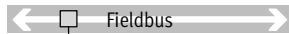

CDVI-DN valve terminals with fieldbus interfaces can be equipped with 4, 6, 8 or 12 valve positions and 4 to 24 solenoid coils.

Variants

- DeviceNet connection
- 4 to 24 solenoid coils

## Valve terminals for extension

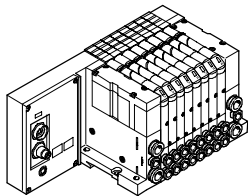

CPA valve terminal

- Max. 16 valves
- Size 10, 14

Further information

➔ Info 214 Valve terminal CPA

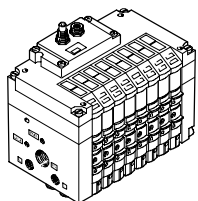

CPV valve terminal

- Max. 16 valves in 8 valve slices
- Size 10, 14, 18

Further information

➔ Info 213 Valve terminal CPV

## CP installation system input/output modules

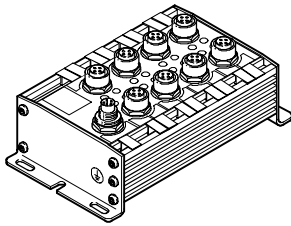

CP-E16-M12x2-5POL  
CP-E16N-M12x2-5POL

- 16 inputs 24 V DC
- Signal status display via 16 LEDs
- Operating status display
- M12 plug, double allocation
- 1x M9 CP connection
- PNP/NPN, IP65

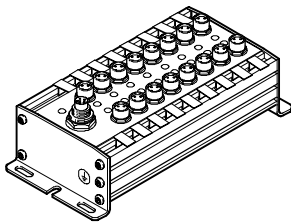

CP-E16-M8  
CP-E16N-M8

- 16 inputs 24 V DC
- Signal status display via 16 LEDs
- Operating status display
- M8 plug, single allocation
- 1x M9 CP connection
- PNP/NPN, IP65

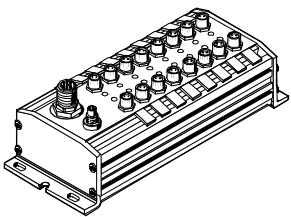

CP-E16-M8-Z

- 16 inputs 24 V DC
- Signal status display via 16 LEDs
- Operating status display
- Electrical isolation through additional power supply
- M8 plug, single allocation
- 1x M9 CP connection
- Separate sensor supply
- PNP/NPN, IP65

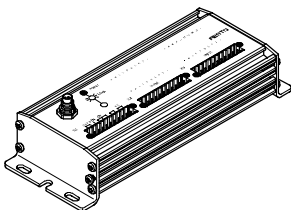

CP-E16-KL-IP20-Z

- 2x 8 inputs 24 V DC
- Signal status display via 16 LEDs
- Operating status display
- Screw terminal or tension-spring sockets
- 1x M9 CP connection
- Separate sensor supply
- PNP/NPN, IP20

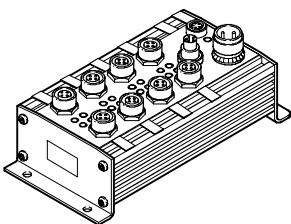

CP-A08-M12-5POL  
CP-A08N-M12

- 8 outputs 24 V DC
- Output signal display via 8 LEDs
- Operating status display
- M12 plug, single allocation
- 2x M9 CP connection
- Separate load voltage
- Outputs resistant to overloads and short circuits
- PNP/NPN, IP65

Detailed description of input and output modules

➔ Info 221 CP installation system

## CP Compact Line input/output modules

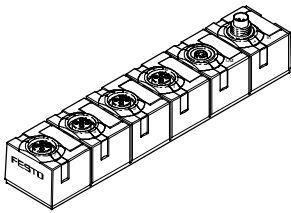

CP-E08-M12x2-CL

- 8 inputs 24 V DC
- Signal status display via 8 LEDs
- Operating status display
- 4x M12 plug, 5-pin, double allocation
- 2x M9 CP connection
- PNP, IP65/67

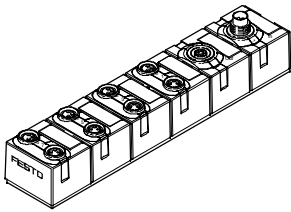

CP-E08-M8-CL

- 8 inputs 24 V DC
- Signal status display via 8 LEDs
- Operating status display
- 8x M8 plug, 3-pin, single allocation
- 2x M9 CP connection
- PNP, IP65/67

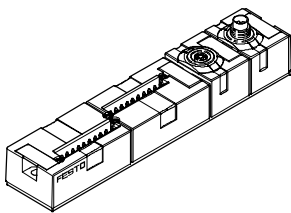

CP-E16-KL-CL

- 16 inputs 24 V DC
- Indirect signal status display via LEDs in the connection set of the tension-spring socket
- Operating status display
- Screw terminal or tension-spring sockets
- 2x M9 CP connection
- PNP, IP20

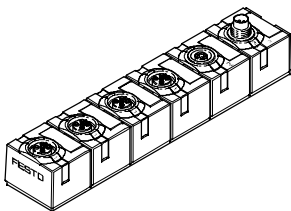

CP-A04-M12x2-CL

- 4 outputs 24 V DC
- Signal status display via 4 LEDs
- Operating status display
- 4x M12 plug, 5-pin, double allocation
- 2x M9 CP connection
- Outputs resistant to overloads and short circuits
- PNP, IP65/67

Detailed description of input and output modules

➔ Info 221 CP installation system

## CP connecting cable

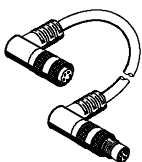

The CP string is connected using pre-assembled CP cables, which are supplied in lengths from 0.5 to 8 metres.

# Fieldbus Direct, CPV-DI01

Technical data – Fieldbus node CPV-DI01



CPV fieldbus node for communication between a CPV valve terminal and a fieldbus master. The fieldbus node is used for activation of a CPV valve terminal with 8 valve slices and 16 solenoid coils and for displaying the switching status via LED. The CPV-... valves are activated using automatic current reduction, which results in less power consumption and heat emission. 16 digital inputs and 8 digital outputs or 16 valves can be connected via a serial CP string extension.

DI01 supports 4 different fieldbus protocols, which are selected by means of DIL switches:

- Profibus DP
- Moeller SUCOnet K
- ABB CS31
- Festo fieldbus

The CPV fieldbus node is available in three sizes, with identical performance characteristics:

- CPV10
- CPV14
- CPV18



## Application

### Bus connection

#### Sub-D socket

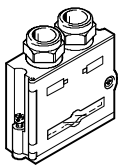

#### M12 adapter

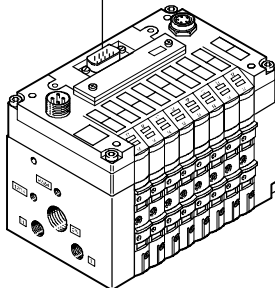
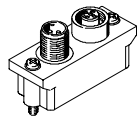
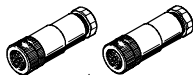

#### Sub-D socket

- 9-pin Sub-D socket
- Installation with IP65 protection

The bus connection is established via a 9-pin Sub-D socket with a typical Profibus allocation (to EN 50 170). The bus connector plug (with protection class IP65 from Festo or IP20 from other manufacturers) facilitates the connection of an incoming and an outgoing bus cable. An active bus terminal can be connected using the integrated DIL switch. The Sub-D interface is designed for the control of network components with a fibre optic cable connection.

#### M12 adapter

- Push-in connector 2xM12
- Installation with IP65 protection

Alternatively the bus connection can be established via a 2x M12 adapter plug (B-coded).

# Fieldbus Direct, CPV-DI01



Technical data – Fieldbus node CPV-DI01

General technical data				
Type		CPV10-GE-DI01-8	CPV14-GE-DI01-8	CPV18-GE-DI01-8
Part No.		165 809	165 811	165 813
CP string extension		Yes 16 inputs and 16 outputs		
Baud rates	[kBaud]	9.6 ... 12,000; automatic detection		
Addressing range	Profibus DP (12 MBaud) Festo fieldbus ABB CS31 Moeller SUCONET K	1 ... 125 Set using switch module		
Product family		4: Valves		
Ident. number		0xC9		
Type of communication		Cyclic communication		
Configuration support		GSD file and bitmaps		
Max. no. of solenoid coils		2x16		
Max. no. of outputs		8 (1x16 solenoid coils omitted)		
Max. no. of inputs		16		
LED diagnostic displays	POWER	Operating voltage for electronics and load supply		
	BUS	Communication and configuration errors		
Device-specific diagnosis via PROFIBUS DP		Short circuit/overload of outputs Undervoltage of valves Undervoltage of outputs Undervoltage of sensor supply Missing module on CP string extension		
Operating voltage	Nominal value	[V DC]	Reverse polarity protected Bus interface and logic, pin 1 Solenoid valve, pin 2	
	Permissible range	[V]	20.4 ... 26.4	
Current consumption		[mA]	Max. 100	
Protection class to EN 60 529			IP65	
Approval			CE	
Temperature range	Operating	[°C]	-5 ... +50	
	Storage	[°C]	-20 ... +70	
Materials	Housing		Die-cast aluminium	
	Plug cap		Polyamide, glass fibre (Ultramide)	
	Seal		Perbunan, Neoprene	
Dimensions			➔ Info 213 Valve terminal CPV	
Weight			➔ Info 213	
Technical data for valves			➔ Info 213	

# Fieldbus Direct, CPV-DI01

Technical data – Fieldbus node CPV-DI01



## Connection and display components

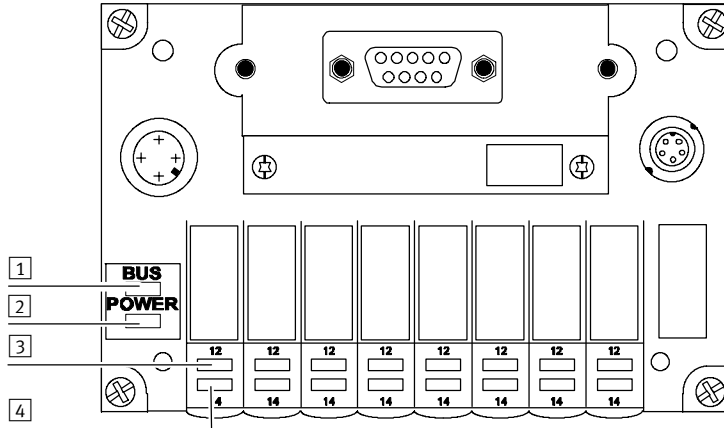

- 1 Red LED: Bus status/error (BUS)
- 2 Green LED: Power supply (POWER)
- 3 Yellow LED row: For pilot solenoid coils 12
- 4 Yellow LED row: For pilot solenoid coils 14

### Pin allocation for fieldbus interface (plug view)

	Pin	Festo Sub-D plug (IP65)	Manufacturer-specific signal designation				
			Festo fieldbus interface	ABB CS31	PROFIBUS DP	Moeller SUCONET K	
						Sub-D, 9-pin	DIN (round) 5-pin
	1				n.c.		
	2				n.c.		
	3	B	S+	Bus1	RxD/TxD-P	3 (T <sub>A</sub> /R <sub>A</sub> )	4 (T <sub>A</sub> /R <sub>A</sub> )
	4				CNTR-P		
	5				DGND		
	6				VP		
	7				n.c.		
	8	A	S-	Bus2	RxD/TxD-N	7 (T <sub>B</sub> /R <sub>B</sub> )	1 (T <sub>B</sub> /R <sub>B</sub> )
	9				n.c.		
Housing	Cable clip	Screen	Screen	Screen	4 (screen)	Housing	





### Pin allocation for M12 adapter

	Profibus DP (signal)	Bus In (pin)	Bus Out (socket)	Designation
	Screen	M12 and 5	M12 and 5	Screen or functional earthing
	RxD / TxD-P	4	4	Data B
	DGND	-	3	Reference potential to supply voltage plus (VP)
	VP (P5V)	-	1	Supply voltage – Plus
	RxD / TxD-N	2	2	Data A

# Fieldbus Direct, CPV-DI01

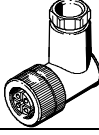
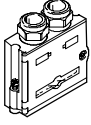
FESTO

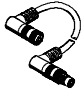
Accessories – Fieldbus node CPV-DI01

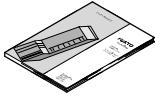
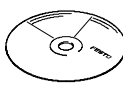
Ordering data				
Designation			Type	Part No.
<b>Power supply</b>				
	Power supply socket, straight		FBSD-GD-7	18 497
			FBSD-GD-9	18 495
	Power supply socket, angled		FBSD-WD-7	18 524
			FBSD-WD-9	18 525
<b>Fieldbus connection</b>				
	Fieldbus socket, Sub-D connection		FBS-Sub-9-GS-DP-B	532 216
	M12 adapter		FBA-2-M12-5POL-RK	533 118
<b>Valve terminal connection</b>				
	Connecting cable WS-WD	0.5 m	KVI-CP-1-WS-WD-0,5	178 564
		1 m	KVI-CP-1-WS-WD-1.0	191 892
		2 m	KVI-CP-1-WS-WD-2	163 139
		3 m	KVI-CP-1-WS-WD-3.0	191 893
		5 m	KVI-CP-1-WS-WD-5	163 138
	Connecting cable GS-WD	5 m	KVI-CP-1-GS-WD-5	163 137
		8 m	KVI-CP-1-GS-WD-8	163 136
	Connecting cable GS-GD	2 m, for chain link trunking	KVI-CP-2-GS-GD-2	170 234
		5 m, for chain link trunking	KVI-CP-2-GS-GD-5	170 235
		8 m, for chain link trunking	KVI-CP-2-GS-GD-8	165 616
<b>User documentation</b>				
	User documentation for CPV Direct, CPV fieldbus node DI01	German	P.BE-CP-DI01-DE	165 816
		English	P.BE-CP-DI01-EN	165 817
		Italian	P.BE-CP-DI01-IT	165 818
		French	P.BE-CP-DI01-FR	165 819
		Spanish	P.BE-CP-DI01-ES	165 820
		Swedish	P.BE-CP-DI01-SV	165 821
<b>Software</b>				
	CD-ROM	Valve terminal user documentation (PDF)	P.CD-VALVE-T	183 350
		Utilities	P.CD-VI-UTILITIES-2	533 500

# Fieldbus Direct, CPV-DN2

Technical data – Fieldbus node CPV-DN2



CPV fieldbus node for communication between a CPV valve terminal and a fieldbus master. The fieldbus node is used for activation of a CPV valve terminal with 8 valve slices and 16 solenoid coils and for displaying the switching status via LED.

The CPV-... valves are activated using automatic current reduction, which results in less power consumption and heat emission. 16 digital inputs and 8 digital outputs or 16 solenoid coils can be connected via a serial CP string extension.

The CPV fieldbus node supports the DeviceNet protocol and conforms to the equipment profile of the pneumatic valve.

The CPV fieldbus node is available in three sizes, with identical performance characteristics:

- CPV10
- CPV14
- CPV18



## Application

### Bus connection

#### Open Style

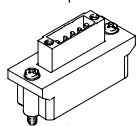
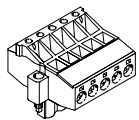

#### Micro Style

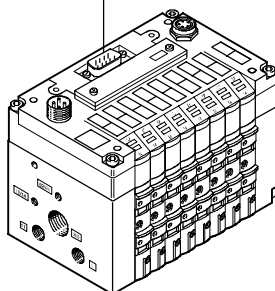
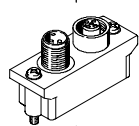
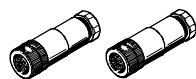

#### Open Style

- 5-pin terminal strip
- For installations in protected environments (IP20)

Open Style offers a 5-pin row with the DeviceNet pin allocation.

If the valve terminal is ordered with this bus connection, the 5-pin screw terminal strip will also be supplied. It is designed with double screw terminals for the incoming and the outgoing bus cable. This connection technology provides the function of a T-distributor.

#### Micro Style

- Push-in connector 2xM12
- Installation with IP65 protection

Micro Style is prepared for connecting through the bus cable with an M12 plug for the incoming cable and a socket for the outgoing bus cable.

The bus connection fulfils the requirement of a T-distributor, this means that the CPV valve terminal can be disconnected from the DeviceNet without interrupting the bus. This method of direct connection does away with the need for the branch line length in the DeviceNet configuration.

# Fieldbus Direct, CPV-DN2

Technical data – Fieldbus node CPV-DN2

## Condition monitoring

Condition monitoring supports the preventative maintenance of the function chain in automation systems. Each valve is assigned a switching cycle counter that automatically

registers movements of the system components. Once a maximum number of activations is reached, a message is

sent to the controller via DeviceNet and maintenance can be started. In the same way condition monitoring supports the determination of the

service intervals for the function chain. All movements immediately after installation are registered.

General technical data			
Type	CPV10-GE-DN2-8		CPV14-GE-DN2-8
Part No.	525 630		525 878
		CPV18-GE-DN2-8	
		525 880	
CP string extension	Yes 16 inputs and 8 outputs (or 16 valves)		
Baud rates	[kbps]	125, 250, 500	
Addressing range	0 ... 63 Set using switch module		
Product family	Pneumatic valve (27 dec.)		
Ident. number	8942 dec.		
Type of communication	Polling, change of state, strobed I/O		
Configuration support	EDS file and graphics symbol		
Max. no. of solenoid coils	2x16		
Max. no. of outputs	8 (1x16 solenoid coils omitted)		
Max. no. of inputs	16		
LED diagnostic displays	PS	Common message concerning supply voltage	
	MNS	DeviceNet status	
Device-specific diagnosis via DeviceNet	Short circuit/overload of outputs Short circuit/overload of inputs Undervoltage of valve terminal Undervoltage of valve terminal (extension) Undervoltage of output module Undervoltage of sensor supply Missing module on CP string Condition monitoring		
Operating voltage	Nominal value	[V]	24 DC, reverse polarity protected
	Permissible range	[V]	20.4 ... 26.4 DC
	Power failure buffering	[ms]	20
Current consumption	[mA]	Max. 200 + sensor supply	
Protection class to EN 60 529	IP65		
Approval	CE		
Temperature range	Operating	[°C]	-5 ... +50
	Storage	[°C]	-20 ... +60
Materials	Housing	Die-cast aluminium	
	Plug cap	Polyamide, glass fibre (Ultramide)	
	Seal	Nitrile rubber, Neoprene	
Dimensions	➔ Info 213 Valve terminal CPV		
Weight	➔ Info 213		
Technical data for valves	➔ Info 213		

# Fieldbus Direct, CPV-DN2

Technical data – Fieldbus node CPV-DN2

## Connection and display components

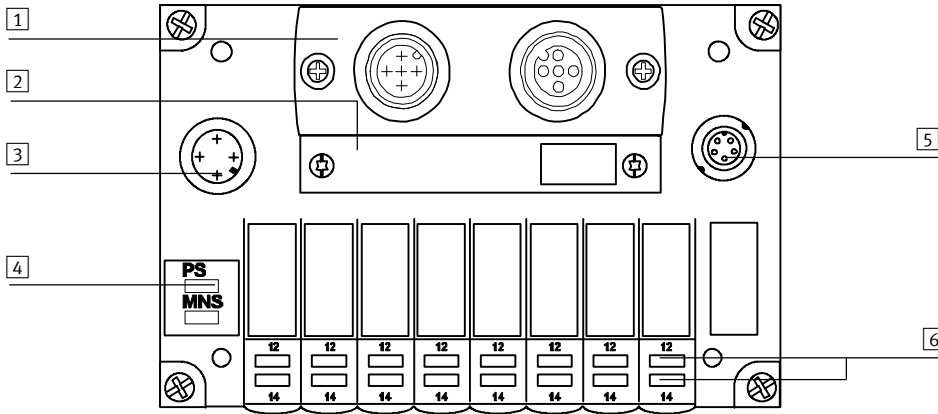

- 1 Interchangeable fieldbus connection:
  - Micro Style connection (2xM12)
  - Open Style connection (terminal strip)
  - 9-pin Sub-D plug
- 2 Switch module (removable)
- 3 Connection for voltage supply (4-pin M12 plug, operating voltage for electronics, load voltage for CP valves)
- 4 LEDs:
  - Power status (PS)
  - Module/network status (MNS)
- 5 CP extension connection
- 6 Switching status displays of CPV solenoid coils

### Pin allocation for M12 adapter

	Pin	Signal-specific core colour	Signal	Designation
	1	blank	Screen	Connection to housing
	2	red	24 V DC bus	24 V supply CAN interface
	3	black	0 V bus	0 V CAN interface
	4	white	CAN_H	Received/transmitted data high
	5	blue	CAN_L	Received/transmitted data low







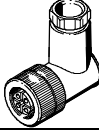

### Pin allocation for Open Style adapter

	Pin	Signal-specific core colour	Signal	Designation
	1	black	0 V bus	0 V CAN interface
	2	blue	CAN_L	Received/transmitted data low
	3	blank	Screen	Connection to housing
	4	white	CAN_H	Received/transmitted data high
	5	red	24 V DC bus	24 V DC supply CAN interface

# Fieldbus Direct, CPV-DN2

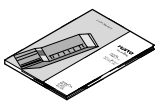
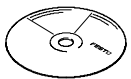

Accessories – Fieldbus node CPV-DN2

Ordering data				
Designation			Type	Part No.
<b>Power supply</b>				
	Power supply socket, straight		FBSD-GD-7	18 497
			FBSD-GD-9	18 495
	Power supply socket, angled		FBSD-WD-7	18 524
			FBSD-WD-9	18 525
<b>Bus connection Micro Style M12</b>				
	Bus connection Micro Style, 2xM12		FBA-2-M12-5POL	525 632
	Fieldbus socket for Micro Style connection, M12, 5-pin, straight		FBSD-GD-9-5POL	18 324
	Plug for Micro Style connection, M12, 5-pin, straight		FBS-M12-5GS-PG9	175 380
<b>Bus connection Open Style, 5-pin screw terminal strip</b>				
	Bus connection Open Style for 5-pin terminal strip		FBA-1-SL-5POL	525 634
	Bus connection, 5-pin terminal strip		FBSD-KL-2x5POL	525 635
<b>Valve terminal connection</b>				
	Connecting cable WS-WD	0.5 m	KVI-CP-1-WS-WD-0,5	178 564
		1 m	KVI-CP-1-WS-WD-1.0	191 892
		2 m	KVI-CP-1-WS-WD-2	163 139
		3 m	KVI-CP-1-WS-WD-3.0	191 893
		5 m	KVI-CP-1-WS-WD-5	163 138
	Connecting cable GS-WD	5 m	KVI-CP-1-GS-WD-5	163 137
		8 m	KVI-CP-1-GS-WD-8	163 136
	Connecting cable GS-GD	2 m, for chain link trunking	KVI-CP-2-GS-GD-2	170 234
		5 m, for chain link trunking	KVI-CP-2-GS-GD-5	170 235
		8 m, for chain link trunking	KVI-CP-2-GS-GD-8	165 616
<b>User documentation</b>				
	User documentation for CPV Direct, CPV fieldbus node DN2	German	P.BE-CP-DN2-DE	526 016
		English	P.BE-CP-DN2-EN	526 017
		Italian	P.BE-CP-DN2-IT	526 018
		French	P.BE-CP-DN2-FR	526 019
		Spanish	P.BE-CP-DN2-ES	526 020
		Swedish	P.BE-CP-DN2-SV	526 021
<b>Software</b>				
	CD-ROM	Valve terminal user documentation (PDF)	P.CD-VALVE-T	183 350
		Utilities	P.CD-VI-UTILITIES-2	533 500

## Fieldbus Direct, CPASC1-AE32-DN

Technical data – Fieldbus node CPASC1-AE32-DN

FESTO



CPASC1 fieldbus node for communication between a CPASC1 valve terminal and a fieldbus master. The fieldbus node is used for activation of a CPASC1 valve terminal with up to 32 solenoid coils on max. 24 valve positions and for displaying the switching status via LED.

The CPASC1... valves are activated using automatic current reduction, which results in less power consumption and heat emission. 16 digital inputs and 8 digital outputs or 16 solenoid coils can be connected via a serial CP string extension. The CPASC1 fieldbus node supports the DeviceNet protocol and conforms to the equipment profile of the pneumatic valve.



### Application

#### Bus connection

The DeviceNet connection is established via a 5-pin M12 plug with pins that corresponds to the specific mini connector. A DeviceNet installation with a higher degree of protection is typically configured using main and branch lines that are connected via T-pieces.

Various manufacturers such as Turck, Lumberg and Rockwell offer finished cables and terminating resistors. The terminating resistors are attached to the two outermost T-pieces. This installation technique keeps the bus closed while a bus station is being removed.

In order to prevent confusion when establishing a connection to the fieldbus, a Micro Style M12, 5-pin plug connector with a straight socket (A-coded) is used. A Micro Style M12, 5-pin plug connector with a straight socket (B-coded) is used for the power supply.

# Fieldbus Direct, CPASC1-AE32-DN

Technical data – Fieldbus node CPASC1-AE32-DN

## Condition monitoring

Condition monitoring supports the preventative maintenance of the function chain in automation systems. Each valve is assigned a switching cycle counter that automatically registers movements of the system components. Once a maximum number of activations is reached, a message is sent to the controller via DeviceNet and maintenance can be started. In the same way condition monitoring supports the determination of the service intervals for the function chain. All movements immediately after installation are registered.

General technical data			
Type	CPASC1-AE32-DN		
Part No.	538 652		
CP string extension	Yes 16 inputs and 8 outputs (or 16 valves)		
Baud rates	[kbps]	125, 250, 500	
Addressing range	0 ... 63 Set using switch module		
Product family	Pneumatic valve (27 dec.)		
Ident. number	5250 dec.		
Type of communication	Polling, change of state, strobed I/O		
Configuration support	EDS file and graphics symbol		
Max. no. of solenoid coils	32+16		
Max. no. of outputs	8 (1x16 solenoid coils omitted)		
Max. no. of inputs	16		
LED diagnostic displays	PS	Common message concerning supply voltage	
	PL	Power supply for valves	
	SF	CP system error	
	NET	DeviceNet network status	
	MOD	DeviceNet module status	
Device-specific diagnosis via DeviceNet	Short circuit/overload of outputs Short circuit/overload of inputs Undervoltage of valve terminal Undervoltage of valve terminal (extension) Undervoltage of output module Undervoltage of sensor supply Missing module on CP string Condition monitoring		
Operating voltage	Nominal value	[V]	24 DC, reverse polarity protected
	Permissible range	[V]	20.4 ... 26.4 DC
	Power failure buffering	[ms]	20
Current consumption		[mA]	Max. 200 + sensor supply
Residual ripple		[Vss]	4
Protection class to EN 60 529	IP40 (with fitted cover)		
Vibration resistance	To EN 60 068-2-6: Wall mounting class 2 H-rail mounting class 1		
Shock resistance	To EN 60 068-2-27: Wall mounting class 2 H-rail mounting class 1 To EN 60 068-2-29: Wall mounting class 1 H-rail mounting class 1		
Approval	CE		
Temperature range	Operating	[°C]	-5 ... +50
	Storage	[°C]	-20 ... +50
Materials	Polymer		
Dimensions	➔ Info 211		
Weight	➔ Info 211		
Technical data for valves	➔ Info 211		

# Fieldbus Direct, CPASC1-AE32-DN

Technical data – Fieldbus node CPASC1-AE32-DN

## Connection and display components

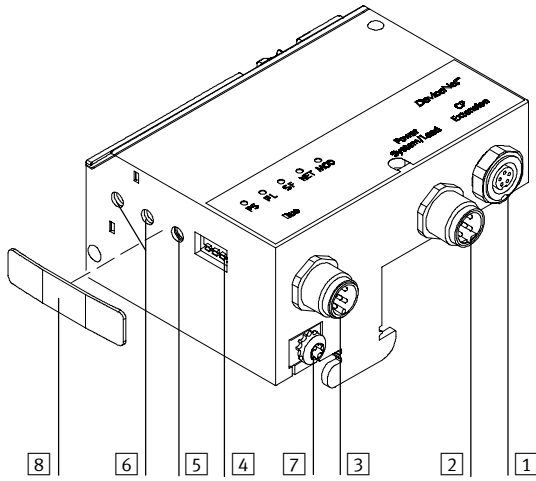

- 1 Connection for CP extension
- 2 Connection for power supply
- 3 Connection for fieldbus
- 4 DIL switch for CP extension
- 5 Rotary switch for baud rate
- 6 Rotary switch for station number
- 7 Earth terminal
- 8 Cover (for IP40 protection)







## Pin allocation for fieldbus interface

	Pin	Signal-specific core colour	Signal	Designation
	1	blank	Screen	Connection to housing
	2	red	24 V DC bus	24 V supply CAN interface
	3	black	0 V bus	0 V CAN interface
	4	white	CAN_H	Received/transmitted data high
	5	blue	CAN_L	Received/transmitted data low

# Fieldbus Direct, CPASC1-AE32-DN

FESTO

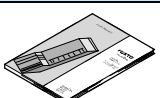
Accessories – Fieldbus node CPASC1-AE32-DN

Ordering data				
Designation		Type	Part No.	
Power supply Micro Style M12				
	Power supply socket, for Micro Style connection, M12, 5-pin, straight socket (B-coded)	NTSD-GD-9-M12-5POL-RK	538 999	
Bus connection Micro Style M12				
	Fieldbus socket for Micro Style connection, M12, 5-pin, straight socket (A-coded)	FBSD-GD-9-5POL	18 324	
Valve terminal connection				
	Connecting cable with angled plug and angled socket	0.5 m	KVI-CP-1-WS-WD-0,5	178 564
		1 m	KVI-CP-1-WS-WD-1.0	191 892
		2 m	KVI-CP-1-WS-WD-2	163 139
		3 m	KVI-CP-1-WS-WD-3.0	191 893
		5 m	KVI-CP-1-WS-WD-5	163 138
	Connecting cable with straight plug and angled socket	5 m	KVI-CP-1-GS-WD-5	163 137
		8 m	KVI-CP-1-GS-WD-8	163 136
	Connecting cable with straight plug and straight socket	2 m, for chain link trunking	KVI-CP-2-GS-GD-2	170 234
		5 m, for chain link trunking	KVI-CP-2-GS-GD-5	170 235
		8 m, for chain link trunking	KVI-CP-2-GS-GD-8	165 616
User documentation				
	User documentation for CPV Direct, CPV fieldbus node DN2	German	P.BE-CPASC-CPVSC-DE	539 008
		English	P.BE-CPASC-CPVSC-EN	539 009
		Italian	P.BE-CPASC-CPVSC-IT	539 010
		French	P.BE-CPASC-CPVSC-FR	539 011
		Spanish	P.BE-CPASC-CPVSC-ES	539 012
		Swedish	P.BE-CPASC-CPVSC-SV	539 013
Software				
	CD-ROM	Valve terminal user documentation (PDF)	P.CD-VALVE-T	183 350
		Utilities	P.CD-VI-UTILITIES-2	533 500

## Fieldbus Direct, CPVSC1-AE16-DN

Technical data – Fieldbus node CPVSC1-AE16-DN

FESTO



CPVSC1 fieldbus node for communication between a CPVSC1 valve terminal and a fieldbus master. The fieldbus node is used for activation of a CPVSC1 valve terminal with up to 16 solenoid coils on max. 16 valve positions and for displaying the switching status via LED.

The CPVSC1... valves are activated using automatic current reduction, which results in less power consumption and heat emission. 16 digital inputs and 8 digital outputs or 16 solenoid coils can be connected via a serial CP string extension. The CPVSC1 fieldbus node supports the DeviceNet protocol and conforms to the equipment profile of the pneumatic valve.



### Application

#### Bus connection

The DeviceNet connection is established via a 5-pin M12 plug with pins that corresponds to the specific mini connector. A DeviceNet installation with a higher degree of protection is typically configured using main and branch lines that are connected via T-pieces.

Various manufacturers such as Turck, Lumberg and Rockwell offer finished cables and terminating resistors. The terminating resistors are attached to the two outermost T-pieces. This installation technique keeps the bus closed while a bus station is being removed.

In order to prevent confusion when establishing a connection to the fieldbus, a Micro Style M12, 5-pin plug connector with a straight socket (A-coded) is used. A Micro Style M12, 5-pin plug connector with a straight socket (B-coded) is used for the power supply.

# Fieldbus Direct, CPVSC1-AE16-DN

Technical data – Fieldbus node CPVSC1-AE16-DN

## Condition monitoring

Condition monitoring supports the preventative maintenance of the function chain in automation systems. Each valve is assigned a switching cycle counter that automatically

registers movements of the system components. Once a maximum number of activations is reached, a message is

sent to the controller via DeviceNet and maintenance can be started. In the same way condition monitoring supports the determination of the

service intervals for the function chain. All movements immediately after installation are registered.

General technical data			
Type	CPVSC1-AE16-DN		
Part No.	538 654		
CP string extension	Yes 16 inputs and 8 outputs (or 16 valves)		
Baud rates	[kbps]	125, 250, 500	
Addressing range	0 ... 63 Set using switch module		
Product family	Pneumatic valve (27 dec.)		
Ident. number	4736 dec.		
Type of communication	Polling, change of state, strobed I/O		
Configuration support	EDS file and graphics symbol		
Max. no. of solenoid coils	2x16		
Max. no. of outputs	8 (1x16 solenoid coils omitted)		
Max. no. of inputs	16		
LED diagnostic displays	PS	Common message concerning supply voltage	
	PL	Power supply for valves	
	SF	CP system error	
	NET	DeviceNet network status	
	MOD	DeviceNet module status	
Device-specific diagnosis via DeviceNet	Short circuit/overload of outputs Short circuit/overload of inputs Undervoltage of valve terminal Undervoltage of valve terminal (extension) Undervoltage of output module Undervoltage of sensor supply Missing module on CP string Condition monitoring		
Operating voltage	Nominal value	[V]	24 DC, reverse polarity protected
	Permissible range	[V]	20.4 ... 26.4 DC
	Power failure buffering	[ms]	20
Current consumption		[mA]	Max. 200 + sensor supply
Residual ripple		[Vss]	4
Protection class to EN 60 529	IP40 (with fitted cover)		
Vibration resistance	To EN 60 068-2-6: Wall mounting class 2 H-rail mounting class 1		
Shock resistance	To EN 60 068-2-27: Wall mounting class 2 H-rail mounting class 1 To EN 60 068-2-29: Wall mounting class 1 H-rail mounting class 1		
Approval	CE		
Temperature range	Operating	[°C]	-5 ... +50
	Storage	[°C]	-20 ... +50
Materials	Polymer		
Dimensions	➔ Info 226		
Weight	➔ Info 226		
Technical data for valves	➔ Info 226		

# Fieldbus Direct, CPVSC1-AE16-DN

Technical data – Fieldbus node CPVSC1-AE16-DN

## Connection and display components

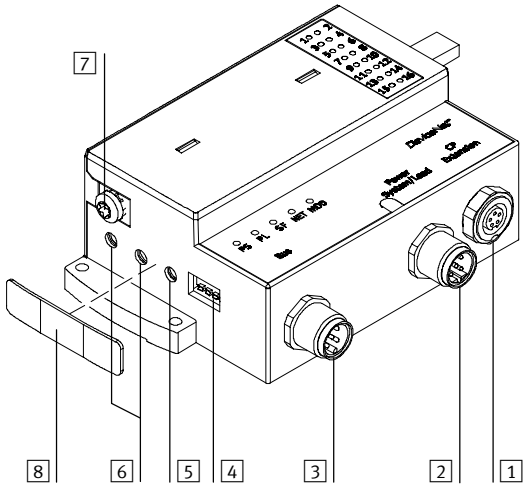

- 1 Connection for CP extension
- 2 Connection for power supply
- 3 Connection for fieldbus
- 4 DIL switch for CP extension
- 5 Rotary switch for baud rate
- 6 Rotary switch for station number
- 7 Earth terminal
- 8 Cover (for IP40 protection)







## Pin allocation for fieldbus interface

	Pin	Signal-specific core colour	Signal	Designation
<p>The diagram shows a circular connector with five pins labeled 1 through 5. Pin 1 is at the top, 2 at the bottom, 3 on the right, 4 on the left, and 5 in the center. The word 'BUS' is written above the connector.</p>	1	blank	Screen	Connection to housing
	2	red	24 V DC bus	24 V supply CAN interface
	3	black	0 V bus	0 V CAN interface
	4	white	CAN_H	Received/transmitted data high
	5	blue	CAN_L	Received/transmitted data low

# Fieldbus Direct, CPVSC1-AE16-DN

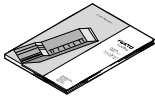

Accessories – Fieldbus node CPVSC1-AE16-DN

Ordering data				
Designation		Type	Part No.	
Power supply Micro Style M12				
	Power supply socket, for Micro Style connection, M12, 5-pin, straight socket (B-coded)	NTSD-GD-9-M12-5POL-RK	538 999	
Bus connection Micro Style M12				
	Fieldbus socket for Micro Style connection, M12, 5-pin, straight socket (A-coded)	FBSD-GD-9-5POL	18 324	
Valve terminal connection				
	Connecting cable with angled plug and angled socket	0.5 m	KVI-CP-1-WS-WD-0,5	178 564
		1 m	KVI-CP-1-WS-WD-1.0	191 892
		2 m	KVI-CP-1-WS-WD-2	163 139
		3 m	KVI-CP-1-WS-WD-3.0	191 893
		5 m	KVI-CP-1-WS-WD-5	163 138
	Connecting cable with straight plug and angled socket	5 m	KVI-CP-1-GS-WD-5	163 137
		8 m	KVI-CP-1-GS-WD-8	163 136
	Connecting cable with straight plug and straight socket	2 m, for chain link trunking	KVI-CP-2-GS-GD-2	170 234
		5 m, for chain link trunking	KVI-CP-2-GS-GD-5	170 235
		8 m, for chain link trunking	KVI-CP-2-GS-GD-8	165 616
User documentation				
	User documentation for CPV Direct, CPV fieldbus node DN2	German	P.BE-CPASC-CPVSC-DE	539 008
		English	P.BE-CPASC-CPVSC-EN	539 009
		Italian	P.BE-CPASC-CPVSC-IT	539 010
		French	P.BE-CPASC-CPVSC-FR	539 011
		Spanish	P.BE-CPASC-CPVSC-ES	539 012
		Swedish	P.BE-CPASC-CPVSC-SV	539 013
Software				
	CD-ROM	Valve terminal user documentation (PDF)	P.CD-VALVE-T	183 350
		Utilities	P.CD-VI-UTILITIES-2	533 500

## Fieldbus Direct, CDVI-DN

Technical data – Fieldbus node CDVI-DN

FESTO



CDVI fieldbus node for communication between a CDVI valve terminal and a fieldbus master. The fieldbus node is used for activation of a CDVI valve terminal with up to 24 solenoid coils on max. 12 valve positions and for displaying the switching status via LED.

The CDVI... valves are activated using automatic current reduction, which results in less power consumption and heat emission. 16 digital inputs and 8 digital outputs or 16 solenoid coils can be connected via a serial CP string extension.

The CDVI fieldbus node supports the DeviceNet protocol and conforms to the equipment profile of the pneumatic valve.



### Application

#### Bus connection

The DeviceNet connection is established via a 5-pin M12 plug with pins that corresponds to the specific mini connector. A DeviceNet installation with a higher degree of protection is typically configured using main and branch lines that are connected via T-pieces.

Various manufacturers such as Turck, Lumberg and Rockwell offer finished cables and terminating resistors. The terminating resistors are attached to the two outermost T-pieces. This installation technique keeps the bus closed while a bus station is being removed.

In order to prevent confusion when establishing a connection to the fieldbus, a Micro Style M12, 5-pin plug connector with a straight socket (A-coded) is used. A Micro Style M12, 5-pin plug connector with a straight socket (B-coded) is used for the power supply.

# Fieldbus Direct, CDVI-DN

Technical data – Fieldbus node CDVI-DN

FESTO

## Condition monitoring

Condition monitoring supports the preventative maintenance of the function chain in automation systems. Each valve is assigned a switching cycle counter that automatically

registers movements of the system components. Once a maximum number of activations is reached, a message is

sent to the controller via DeviceNet and maintenance can be started. In the same way condition monitoring supports the determination of the

service intervals for the function chain. All movements immediately after installation are registered.

General technical data			
Type	CDVI-DN		
Part No.	197 648		
CP string extension	Yes 16 inputs and 8 outputs (or 16 valves)		
Baud rates	[kbps]	125, 250, 500	
Addressing range	0 ... 63 Set using switch module		
Product family	Communication adapter (12 dec.)		
Ident. number	5141 dec.		
Type of communication	Polling, change of state		
Configuration support	EDS file and graphics symbol		
Max. no. of solenoid coils	24+16		
Max. no. of outputs	8 (1x16 solenoid coils omitted)		
Max. no. of inputs	16		
LED diagnostic displays	PS	Common message concerning supply voltage	
	PL	Power supply for valves	
	MNS	DeviceNet module/network status	
	CP	CP extension modules	
Device-specific diagnosis via DeviceNet	Short circuit/overload of outputs Short circuit/overload of inputs Undervoltage of valve terminal Undervoltage of valve terminal (extension) Undervoltage of output module Undervoltage of sensor supply Missing module on CP string Condition monitoring		
Operating voltage	Nominal value	[V]	24 DC, reverse polarity protected
	Permissible range	[V]	20.4 ... 26.4 DC
	Power failure buffering	[ms]	20
Current consumption		[mA]	Max. 100 + sensor supply
Residual ripple		[Vss]	4
Protection class to EN 60 529	IP66, IP67, IP69k <sup>1)</sup>		
Vibration resistance	To EN 60 068-2-6: Wall mounting class 2 H-rail mounting class 1		
Shock resistance	To EN 60 068-2-27: Wall mounting class 2 H-rail mounting class 1 To EN 60 068-2-29: Wall mounting class 1 H-rail mounting class 1		
Approval	CE		
Temperature range	Operating	[°C]	-5 ... +50
	Storage	[°C]	-20 ... +40
Materials	Info 204		
Dimensions (LxWxD)		[mm]	Info 204
Weight		[g]	Info 204

1) To DIN 40 050 Part 9 (only up to 50 bar at 80°C; with sealed CP connection)  
Type 4 to NEMA 250 (hose-down test, test no. 5.7)

# Fieldbus Direct, CDVI-DN

Technical data – Fieldbus node CDVI-DN

## Connection and display components

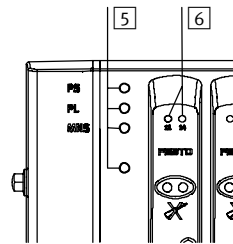
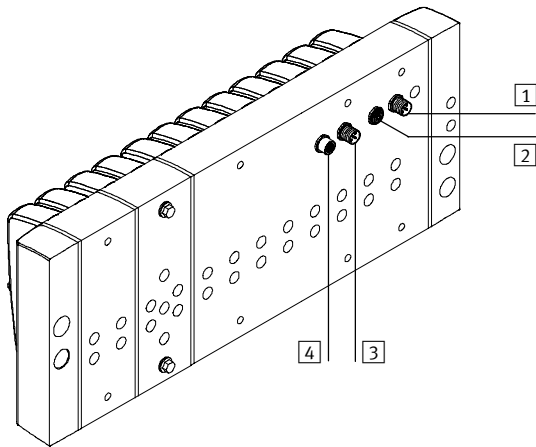

- 1 Power supply (plug, M12)
- 2 CP extension (M9)
- 3 Fieldbus input (plug, M12)
- 4 Fieldbus output (socket, M12)
- 5 PS Power system  
Operating voltage of electronics
- PL Power load  
Load voltage of valves
- MNS Module/network status
- CP Compact Performance  
CP extension modules
- 6 Status display of the solenoid coils

### Pin allocation for fieldbus interface (M12 socket)

	Pin	Signal-specific core colour	Signal	Designation
	1	blank	Screen	Connection to housing
	2	red	24 V DC bus	24 V supply CAN interface
	3	black	0 V bus	0 V CAN interface
	4	white	CAN_H	Received/transmitted data high
	5	blue	CAN_L	Received/transmitted data low







### Pin allocation for fieldbus interface (M12 plug)

	Pin	Signal-specific core colour	Signal	Designation
	1	blank	Screen	Connection to housing
	2	red	24 V DC bus	24 V supply CAN interface
	3	black	0 V bus	0 V CAN interface
	4	white	CAN_H	Received/transmitted data high
	5	blue	CAN_L	Received/transmitted data low

# Fieldbus Direct, CDVI-DN

Accessories – Fieldbus node CDVI-DN

**FESTO**

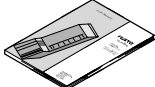
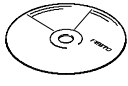
Ordering data				
Designation		Type	Part No.	
Power supply Micro Style M12				
	Power supply socket, for Micro Style connection, M12, 5-pin, straight socket (A-coded)	FBSD-GD-9-5POL	18 324	
Bus connection Micro Style M12				
	Micro Style connection, M12, 5-pin, straight socket (A-coded)	FBSD-GD-9-5POL	18 324	
	Micro Style connection, M12, 5-pin, straight plug (A-coded)	FBS-M12-5GS-PG9	17 538	
Valve terminal connection				
	Connecting cable with angled plug and angled socket	0.5 m	KVI-CP-1-WS-WD-0,5	178 564
		1 m	KVI-CP-1-WS-WD-1.0	191 892
		2 m	KVI-CP-1-WS-WD-2	163 139
		3 m	KVI-CP-1-WS-WD-3.0	191 893
		5 m	KVI-CP-1-WS-WD-5	163 138
	Connecting cable with straight plug and angled socket	5 m	KVI-CP-1-GS-WD-5	163 137
		8 m	KVI-CP-1-GS-WD-8	163 136
	Connecting cable with straight plug and straight socket	2 m, for chain link trunking	KVI-CP-2-GS-GD-2	170 234
		5 m, for chain link trunking	KVI-CP-2-GS-GD-5	170 235
		8 m, for chain link trunking	KVI-CP-2-GS-GD-8	165 616
User documentation				
	User documentation for CDVI-DN	German	P.BE-CDVI-DN-DE	539 044
		English	P.BE-CDVI-DN-EN	539 045
		Italian	P.BE-CDVI-DN-IT	539 048
		French	P.BE-CDVI-DN-FR	539 047
		Spanish	P.BE-CDVI-DN-ES	539 046
		Swedish	P.BE-CDVI-DN-SV	539 049
Software				
	CD-ROM	Valve terminal user documentation (PDF)	P.CD-VALVE-T	183 350
		Utilities	P.CD-VI-UTILITIES-2	533 500

# Fieldbus Direct, CPV-C02

Technical data – Fieldbus node CPV-C02



CPV fieldbus node for communication between a CPV valve terminal and a fieldbus master. The fieldbus node is used for activation of a CPV valve terminal with 8 valve slices and 16 solenoid coils and for displaying the switching status via LED.

The CPV-... valves are activated using automatic current reduction, which results in less power consumption and heat emission. 16 digital inputs and 8 digital outputs or 16 solenoid coils can be connected via a serial CP string extension.

The CPV valve terminal supports the CANopen protocol as per the specifications:

- DS 301, V4.02
- DS 401, V2.1

The CPV fieldbus node is available in three sizes, with identical performance characteristics:

- CPV10
- CPV14
- CPV18



## Application

### Bus connection

#### Screw terminals

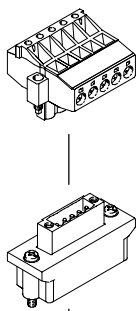

#### Plug connector 2xM12

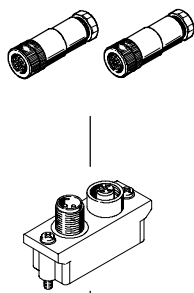

#### Sub-D fieldbus plug

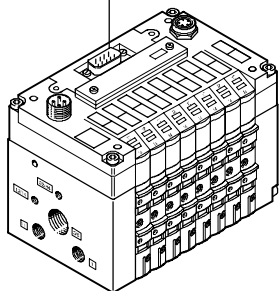
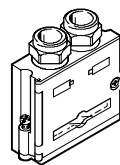

The branch line length does not apply no matter what type of connection is used.

#### Screw terminals

- 5-pin screw terminal strip
- For installations in protected environments (IP20)

The bus connection is established via a 5-pin row.

If the valve terminal is ordered with this bus connection, the 5-pin screw terminal strip will also be supplied. It is designed with double screw terminals for the incoming and the outgoing bus cable. This connection technology provides the function of a T-distributor.

#### Plug connector 2xM12

- Plug connector 2xM12
- Installation with IP65 protection

The bus connection is established via an M12 plug and socket.

The bus connection fulfils the requirement of a T-distributor, this means that the CPV valve terminal can be disconnected from the bus without interrupting the bus.

#### Sub-D fieldbus plug

- 9-pin Sub-D plug
  - Installation with IP65 protection
- The bus connection is established via a 9-pin Sub-D plug as per the CAN in Automation (CiA) specification DS102 with additional 24 V CAN transceiver supply (option as per DS102). The bus connector plug facilitates the connection of an incoming and an outgoing bus cable. There are spring-loaded terminals for the four wires (CAN\_L, CAN\_H, 24 V, 0 V) of the incoming and outgoing bus cable.

# Fieldbus Direct, CPV-C02

Technical data – Fieldbus node CPV-C02



## Condition monitoring

Condition monitoring supports the preventative maintenance of the function chain in automation systems. Each valve is assigned a switching cycle counter that automatically

registers movements of the system components. Once a maximum number of activations is reached, a message is

sent to the controller via CANopen and maintenance can be started. In the same way condition monitoring supports the determination of the

service intervals for the function chain. All movements immediately after installation are registered.

General technical data			
Type		CPV10-GE-C02-8	CPV14-GE-C02-8
Part No.		525 876	525 882
			CPV18-GE-C02-8
			525 884
CP string extension		Yes 16 inputs and 8 outputs (or 16 valves)	
Fieldbus interface		<ul style="list-style-type: none"> <li>■ Sub-D, 9-pin, socket (to DS102)</li> <li>■ Bus interface electrically isolated via optocoupler, 24 V DC supply</li> <li>■ CAN interface via bus</li> </ul>	
Baud rates	[kbps]	125, 250, 500 and 1000 Set using DIL switch	
Addressing range		Node ID 1 ... 127 Set using DIL switch	
Product family		Digital I/O	
Communication profile		DS 301, V4.02	
Device profile		DS 401, V2.1	
Number of PDOs		1 Tx/Rx	
Number of SDOs		1 server SDO	
Configuration support		EDS file and bitmaps	
Max. address volume, inputs	[Byte]	8	
Max. address volume, outputs	[Byte]	8	
Max. no. of solenoid coils		2x16	
Max. no. of outputs		8 (1x16 solenoid coils omitted)	
Max. no. of inputs		16 digital	
LED diagnostic displays	PS	Operating voltage for electronics and load supply	
	MNS	Bus status (module/network status)	
Device-specific diagnosis		Via emergency message and object 1001, 1002 and 1003	
Parameterisation		Via SDO	
Additional functions		Condition counter	
Operating voltage	Nominal value [V DC]	24, reverse polarity protected	
	Permissible range [V]	20.4 ... 26.4	
	Power failure buffering [ms]	10	
Current consumption	[mA]	Max. 200 + sensor supply	
Protection class to EN 60 529		IP65	
Approval		CE, CiA certification	
Temperature range	Operating [°C]	-5 ... +50	
	Storage [°C]	-20 ... +70	
Materials	Housing	Die-cast aluminium	
	Plug cap	Polyamide, glass fibre (Ultramide)	
	Seal	Nitrile rubber, Neoprene	
Dimensions		➔ Info 213 Valve terminal CPV	
Weight		➔ Info 213	
Technical data for valves		➔ Info 213	

# Fieldbus Direct, CPV-C02

Technical data – Fieldbus node CPV-C02



## Connection and display components

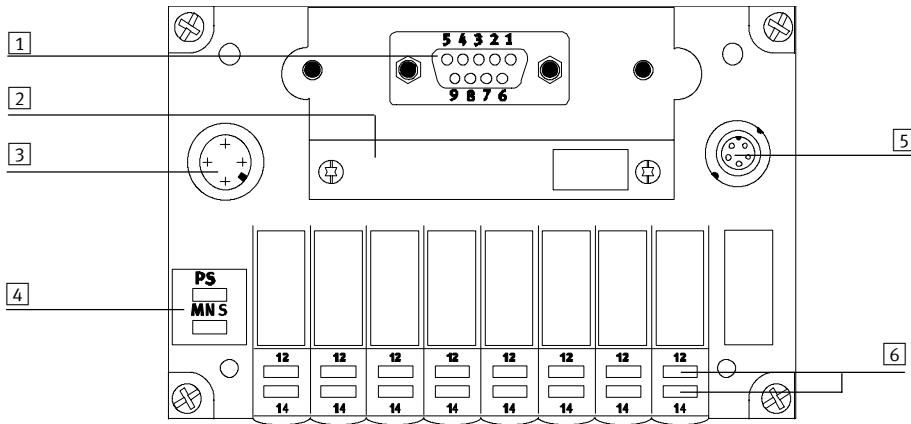

- 1 Fieldbus connection:  
– 9-pin Sub-D plug
- 2 Switch module (removable)
- 3 Connection for voltage supply  
(4-pin M12 plug, operating  
voltage for electronics, load  
voltage for CP valves)
- 4 LEDs:  
– Power status (PS)  
– Module/network status (MNS)
- 5 CP extension connection
- 6 Switching status displays of CPV  
solenoid coils

### Pin allocation for CANopen interface (plug view)

	Pin	Signal	Designation
	1	n.c.	Not connected
	2	CAN_L	Received/transmitted data low
	3	CAN_GND	0 V CAN interface
	4	n.c.	Not connected
	5	CAN_Shld	Optional screened connection
	6	GND	Ground
	7	CAN_H	Received/transmitted data high
	8	n.c.	Not connected
	9	CAN_V+	24 V supply CAN interface
	Housing	Screen	Connection to functional earth

### Pin allocation for M12 adapter

	Pin	Signal	Designation
	1	Screen	Connection to housing
	2	CAN_V+	24 V supply CAN interface
	3	CAN_GND	0 V CAN interface
	4	CAN_H	Received/transmitted data high
	5	CAN_L	Received/transmitted data low







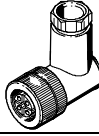
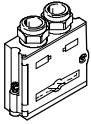

### Pin allocation for Open Style adapter

	Pin	Signal	Designation
	1	CAN_GND	0 V CAN interface
	2	CAN_L	Received/transmitted data low
	3	Screen	Connection to housing
	4	CAN_H	Received/transmitted data high
	5	CAN_V+	24 V supply CAN interface

# Fieldbus Direct, CPV-C02

Technical data – Fieldbus node CPV-C02



Ordering data				
Designation			Type	Part No.
<b>Power supply</b>				
	Power supply socket, straight		FBSD-GD-7	18 497
			FBSD-GD-9	18 495
	Power supply socket, angled		FBSD-WD-7	18 524
			FBSD-WD-9	18 525
<b>Bus connection</b>				
	Sub-D plug for CANopen		FBS-Sub-9-BU-2x5POL-B	532 219
	Mounting screw for standard Sub-D (IP20)		UNC 4-40/M3x5	340 960
<b>Bus connection 2xM12</b>				
	M12 adapter		FBA-2-M12-5POL	525 632
	Fieldbus socket, M12, 5-pin, straight		FBSD-GD-9-5POL	18 324
	Plug, M12, 5-pin, straight		FBS-M12-5GS-PG9	175 380
<b>Bus connection, 5-pin, screw terminal strip</b>				
	Open Style adapter for 5-pin terminal strip		FBA-1-SL-5POL	525 634
	5-pin terminal strip		FBSD-KL-2x5POL	525 635
<b>Valve terminal connection</b>				
	Connecting cable WS-WD	0.5 m	KVI-CP-1-WS-WD-0,5	178 564
		1 m	KVI-CP-1-WS-WD-1.0	191 892
		2 m	KVI-CP-1-WS-WD-2	163 139
		3 m	KVI-CP-1-WS-WD-3.0	191 893
		5 m	KVI-CP-1-WS-WD-5	163 138
	Connecting cable GS-WD	5 m	KVI-CP-1-GS-WD-5	163 137
		8 m	KVI-CP-1-GS-WD-8	163 136
	Connecting cable GS-GD	2 m, for chain link trunking	KVI-CP-2-GS-GD-2	170 234
		5 m, for chain link trunking	KVI-CP-2-GS-GD-5	170 235
		8 m, for chain link trunking	KVI-CP-2-GS-GD-8	165 616

# Fieldbus Direct, CPV-CO2

Accessories – Fieldbus node CPV-CO2

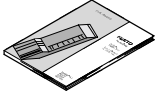
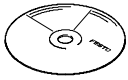

Ordering data				
Designation		Type	Part No.	
User documentation				
	User documentation for CPV Direct, CPV fieldbus node CO2	German	P.BE-CP-CO2-DE	526 009
		English	P.BE-CP-CO2-EN	526 010
		Spanish	P.BE-CP-CO2-ES	526 011
		French	P.BE-CP-CO2-FR	526 012
		Italian	P.BE-CP-CO2-IT	526 013
		Swedish	P.BE-CP-CO2-SV	526 014
Software				
	CD-ROM	Valve terminal user documentation (PDF)	P.CD-VALVE-T	183 350
		Utilities	P.CD-VI-UTILITIES-2	533 500

# Fieldbus Direct, CPV-C02

Fieldbus Direct applications

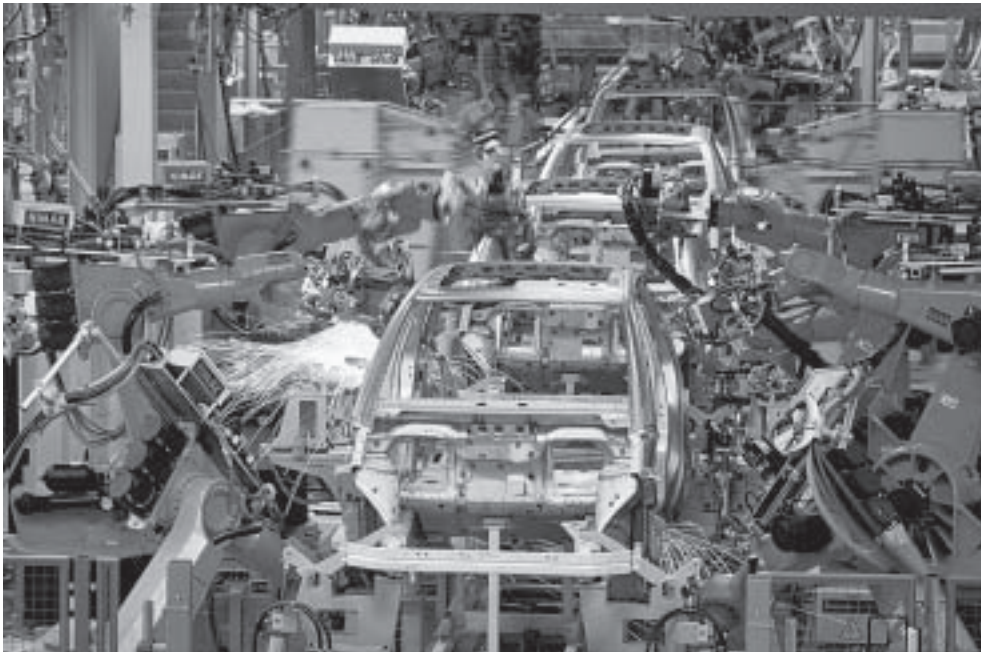

- 1 - Type to be discontinued  
Available until 2008

## Fieldbus Direct, CPV-SD

Technical data – Fieldbus node CPV-SD

FESTO



CPV fieldbus node for communication between a CPV valve terminal and a Smart Distributed System master. The fieldbus node is used for activation of a CPV valve terminal with 8 valve slices and 16 solenoid coils and for displaying the switching status via LED.

The CPV-... valves are activated using automatic current reduction, which results in less power consumption and heat emission.

The CPV fieldbus node supports the Smart Distributed System fieldbus protocol.

The CPV fieldbus node is available in three sizes, with identical performance characteristics:

- CPV10
- CPV14
- CPV18

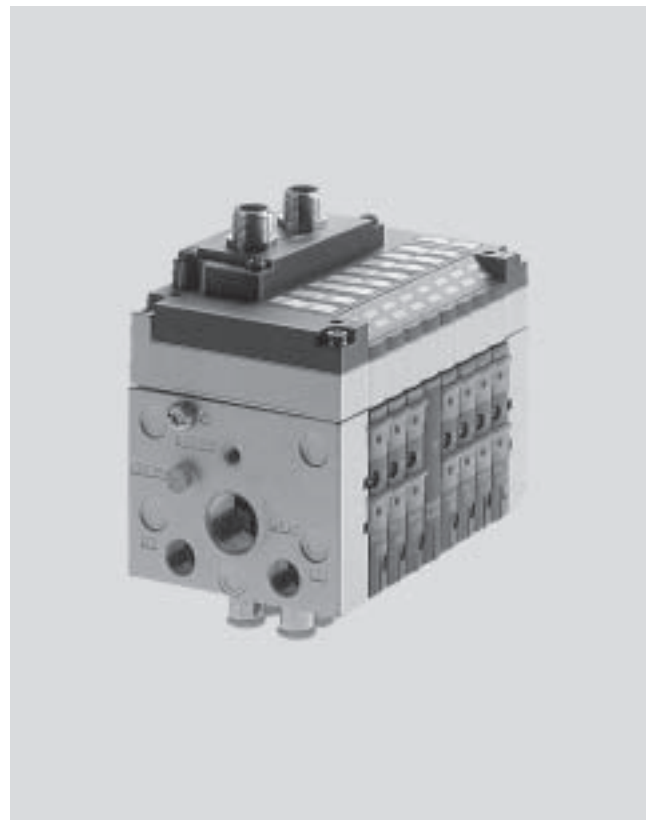

### Application

#### Bus connection

The bus connection is established via 4-pin M12 plugs with protection class IP65.

The bus connection is typically established via a branch line.

The pin allocation corresponds to the Smart Distributed System specification.

The bus connection also includes the 24 V DC supply for the electronics.

**Fieldbus Direct, CPV-SD**

Technical data – Fieldbus node CPV-SD

<b>General technical data</b>		
Type		<b>CPV10-GE-SD-8</b>
Part No.		<b>192 097</b>
CP string extension		No
Baud rates		Automatic baud rate detection
Fieldbus interface		M12, 4-pin
Addressing range		1 ... 126 Set using switch module
Object type		168
Ident. number		113
Max. no. of solenoid coils		16
Max. no. of outputs		0
Max. no. of inputs		0
LED diagnostic displays		Operational status display Valve status
Device-specific diagnosis via SDS		Undervoltage of valves
Operating voltage	Nominal value	[V DC] 24, reverse polarity protected
	Permissible range	[V] 21.0 ... 26.4
	Residual ripple	[Vss] 4
	Power failure buffering	[ms] 20
Current consumption	[mA]	100
Protection class to EN 60 529		IP65
Approval		CE
Temperature range	Operating	[°C] -5 ... +50
	Storage	[°C] -20 ... +70
Materials	Housing	Die-cast aluminium
	Plug cap	Polyamide, glass fibre (Ultramide)
	Seal	Nitrile rubber, Neoprene
Dimensions		➔ Info 213 Valve terminal CPV
Weight		➔ Info 213
Technical data for valves		➔ Info 213

## Fieldbus Direct, CPV-SD

Technical data – Fieldbus node CPV-SD

### Connection and display components

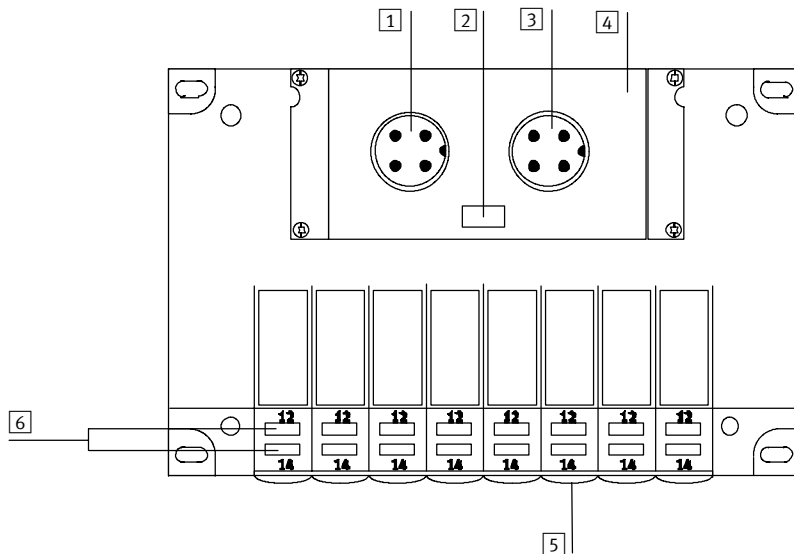

- 1 Load voltage connection for CPV valves
- 2 Diagnostic LED
- 3 Fieldbus/operating voltage connection
- 4 Switch cover
- 5 CP extension connection
- 6 Switching status displays of CPV solenoid coils

### Example of circuit

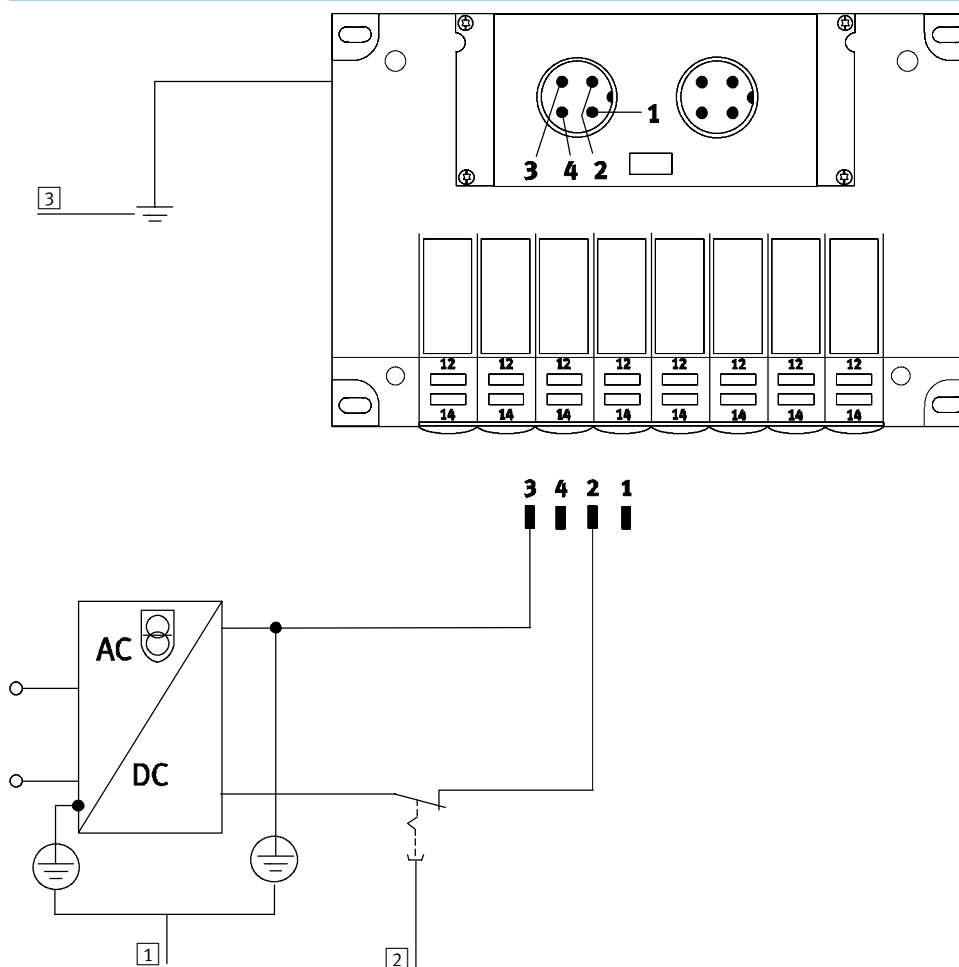

- 1 Connecting cable to equipotential bonding
- 2 The 24 V load supply to the valves can be disconnected separately. The voltage for the bus interface and internal logic is supplied via the fieldbus connection.
- 3 Earth terminal on left-hand end plate

**- 1 - Type to be discontinued**  
**Available until 2008**



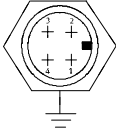

## Fieldbus Direct, CPV-SD

Technical data – Fieldbus node CPV-SD

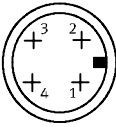
**FESTO**

Pin allocation for fieldbus interface and internal RC resistance network		
	Pin	Signal
	1	DC 24 V bus interface/logic supply
	2	GND/0 V bus interface/logic supply
	3	Data – (CAN_L)
	4	Data + (CAN_H)
	Housing	Earthing with metal M12 socket

Pin allocation for load voltage connection (valve terminal plug view)		
	Pin	Signal
	1	n.c. (not connected)
	2	24 V DC load voltage for CP valves
	3	0 V load voltage for CP valves
	4	n.c. (not connected)

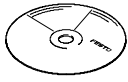
Ordering data			
Designation		Type	Part No.
<b>Power supply</b>			
	Power supply socket, straight	FBSD-GD-7	18 497
		FBSD-GD-9	18 495
	Power supply socket, angled	FBSD-WD-7	18 524
		FBSD-WD-9	18 525
<b>Bus connection M12</b>			
	Fieldbus socket, M12, 5-pin, straight	FBSD-GD-9-5POL	18 324
<b>User documentation</b>			
	User documentation for CPV Direct, CPV fieldbus node SD	German	P.BE-CP-SD8-DE 192 205
		English	P.BE-CP-SD8-EN 192 206
<b>Software</b>			
	CD-ROM	Valve terminal user documentation (PDF)	P.CD-VALVE-T 183 350
		Utilities	P.CD-VI-UTILITIES-2 533 500

# Fieldbus Direct, CPV-IB

Technical data – Fieldbus node CPV-IB



CPV fieldbus node for communication between a CPV valve terminal and an Interbus master. The fieldbus node is used for activation of a CPV valve terminal with 8 valve slices and 16 solenoid coils and for displaying the switching status via LED.

The CPV-... valves are activated using automatic current reduction, which results in less power consumption and heat emission. 16 digital inputs and 8 digital outputs or 16 solenoid coils can be connected via a serial CP string extension.

The CPV fieldbus node IB supports the Interbus fieldbus protocol and represents a remote bus station.

The CPV fieldbus node is available in three sizes, with identical performance characteristics:

- CPV10
- CPV14
- CPV18

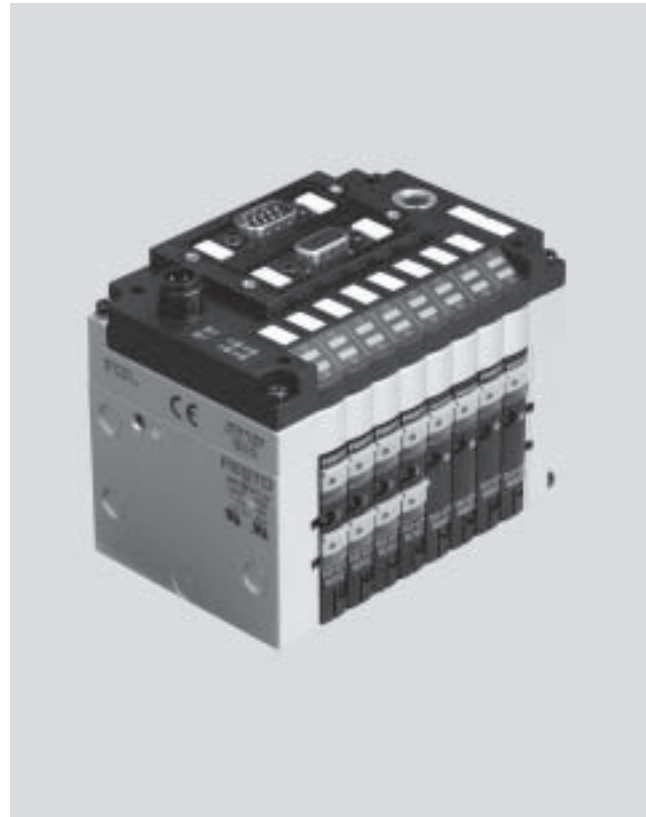

## Application

Bus connection

### Sub-D socket

Interbus incoming

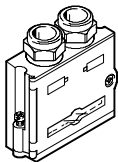

### Sub-D plug

Interbus outgoing

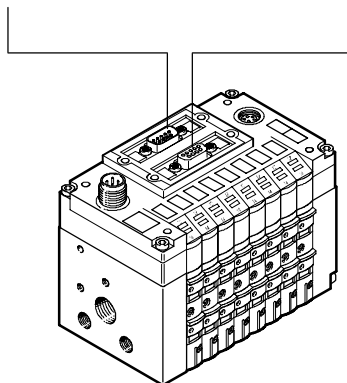
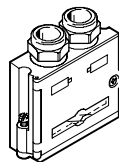

The bus connection is established via a 9-pin Sub-D socket and a 9-pin Sub-D plug with a typical Interbus pin allocation.

The bus connector plugs (with protection class IP65 from Festo or IP20 from other manufacturers) facilitate the connection of the incoming and the outgoing bus cable. The outgoing bus plug contains the typical Interbus RBST bridge for identification of the outgoing bus connection.

The Sub-D interfaces are designed for the control of network components using a fibre optic cable connection.

# Fieldbus Direct, CPV-IB

Technical data – Fieldbus node CPV-IB

General technical data				
Type	CPV10-GE-IB-8		CPV14-GE-IB-8	CPV18-GE-IB-8
Part No.	197 177		197 179	197 181
CP string extension	Yes			16 inputs and 16 outputs
Fieldbus interface	Sub-D, 9-pin, socket and pin			
Baud rates	[kbps]	500, 2000		Set using DIL switch
Bus type	Remote bus			
Profile	12 (digital I/O devices)			
PCP channel	No			
Configuration support	Icons for CMD software			
Max. no. of solenoid coils	2x16			
Max. no. of outputs	8 (1x16 solenoid coils omitted)			
Max. no. of inputs	16			
Max. no. of process data bits	Inputs	32		
	Outputs	32		
LED diagnostic displays	UL	Operating voltage of Interbus interface		
	RC	Remotebus check		
	BA	Bus active		
	RD	Remotebus disable		
	Pow	Operating voltage for electronics and load supply		
	Dia	Short circuit/overload of outputs Undervoltage of valves Undervoltage of outputs Undervoltage of sensor supply Missing module on CP string extension Actual/desired configuration not consistent		
Device-specific diagnosis	Via peripherals errors			
Parameterisation	No			
Additional functions	Diagnosis using status bits (inputs)			
Operating voltage	Nominal value	[V DC]	24, reverse polarity protected	
	Permissible range	[V]	20.4 ... 26.4	
	Residual ripple	[Vss]	4	
	Power failure buffering	[ms]	10	
Current consumption	[mA]	Max. 200 + sensor supply		
Protection class to EN 60 529	IP65			
Approval	CE, Interbus Club certification			
Temperature range	Operating	[°C]	-5 ... +50	
	Storage	[°C]	-20 ... +70	
Materials	Housing	Die-cast aluminium		
	Plug cap	Polyamide, glass fibre (Ultramide)		
	Seal	Nitrile rubber, Neoprene		
Dimensions	➔ Info 213 Valve terminal CPV			
Weight	➔ Info 213 Valve terminal CPV			
Technical data for valves	➔ Info 213 Valve terminal CPV			

# Fieldbus Direct, CPV-IB

Technical data – Fieldbus node CPV-IB

## Connection and display components

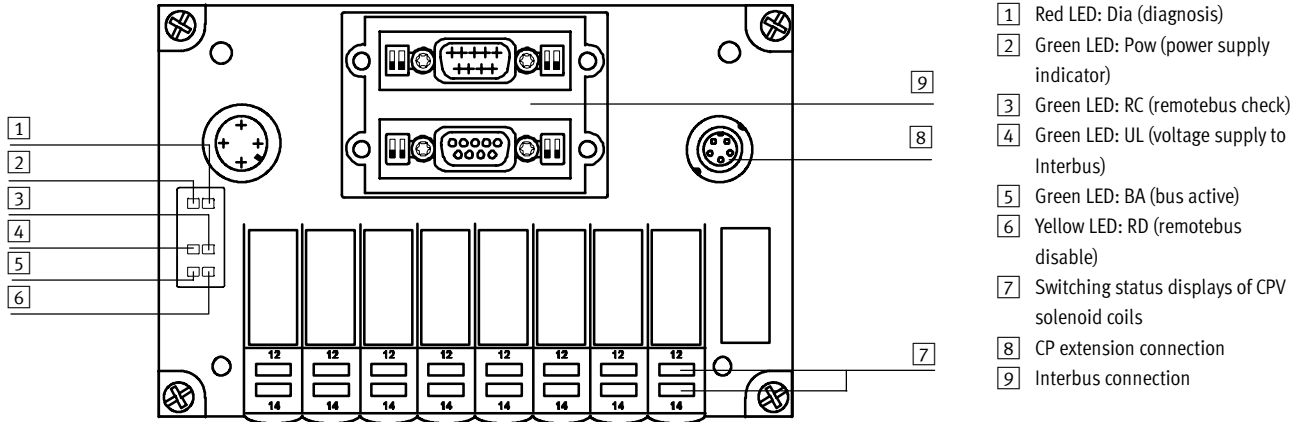

### Pin allocation for Interbus interface, incoming (plug view)

	Pin	Signal	Designation
	1	DO1	Data out
	2	/DI1	Data in
	3	GND	Reference conductor/earth
	4	n.c.	Not connected
	5	n.c.	Not connected
	6	/DO1	Data out inverse
	7	/DI1	Data in inverse
	8	n.c.	Not connected
	9	n.c.	Not connected
	Housing	Screen	Connection to functional earth via R-C combination

### Pin allocation for Interbus interface, outgoing (socket view)









	Pin	Signal	Designation
	1	DO2	Data out
	2	/DI2	Data in
	3	GND	Reference conductor/earth
	4	n.c.	Not connected
	5	+5 V	Station detection <sup>1)</sup>
	6	/DO2	Data out inverse
	7	/DI2	Data in inverse
	8	n.c.	Not connected
	9	RBST	Station detection <sup>1)</sup>
	Housing	Screen	Connection to functional earth via R-C combination

1) The incoming interface is electrically isolated from the CPX peripherals. The plug housing is connected to the FE of the CPX terminal via an R-C combination. The CPX terminal contains the protocol chip SUP1 3 OPC. This ensures automatic detection of additional connected Interbus stations. There is therefore no need for a bridge between pin 5 and pin 9.

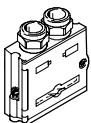
# Fieldbus Direct, CPV-IB

Accessories – Fieldbus node CPV-IB

**FESTO**

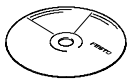
Ordering data				
Designation			Type	Part No.
<b>Power supply</b>				
	Power supply socket, straight		FBSD-GD-7	18 497
			FBSD-GD-9	18 495
	Power supply socket, angled		FBSD-WD-7	18 524
			FBSD-WD-9	18 525
<b>Bus connection</b>				
	Fieldbus plug, Sub-D connection for Interbus incoming		FBS-SUB-9-BU-IB-B	532 218
	Fieldbus plug, Sub-D connection for Interbus outgoing		FBS-SUB-9-GS-IB-B	532 217
	Mounting screw for standard Sub-D (IP20)		UNC 4-40/M3x5	340 960
<b>Valve terminal connection</b>				
	Connecting cable WS-WD	0.5 m	KVI-CP-1-WS-WD-0,5	178 564
		1 m	KVI-CP-1-WS-WD-1.0	191 892
		2 m	KVI-CP-1-WS-WD-2	163 139
		3 m	KVI-CP-1-WS-WD-3.0	191 893
		5 m	KVI-CP-1-WS-WD-5	163 138
	Connecting cable GS-WD	5 m	KVI-CP-1-GS-WD-5	163 137
		8 m	KVI-CP-1-GS-WD-8	163 136
	Connecting cable GS-GD	2 m, for chain link trunking	KVI-CP-2-GS-GD-2	170 234
		5 m, for chain link trunking	KVI-CP-2-GS-GD-5	170 235
		8 m, for chain link trunking	KVI-CP-2-GS-GD-8	165 616
<b>User documentation</b>				
	User documentation for CPV Direct, CPV fieldbus node IB	German	P.BE-CP-IB-DE	527 515
		English	P.BE-CP-IB-EN	527 516
		Spanish	P.BE-CP-IB-ES	527 517
		French	P.BE-CP-IB-FR	527 518
		Italian	P.BE-CP-IB-IT	527 519
		Swedish	P.BE-CP-IB-SV	527 520
<b>Software</b>				
	CD-ROM	Valve terminal user documentation (PDF)	P.CD-VALVE-T	183 350
		Utilities	P.CD-VI-UTILITIES-2	533 500

## Fieldbus Direct, CPV-IL

Technical data – Fieldbus node CPV-IL



CPV fieldbus node for communication between a CPV valve terminal and an Interbus Loop bus terminal. The fieldbus node is used for activation of a CPV valve terminal with 8 valve slices and 16 solenoid coils and for displaying the switching status via LED.

The CPV... valves are activated using automatic current reduction, which results in less power consumption and heat emission.

The CPV fieldbus node supports the fieldbus protocol Interbus Loop2.

The CPV fieldbus node is available in two sizes, with identical performance characteristics:

- CPV10
- CPV14

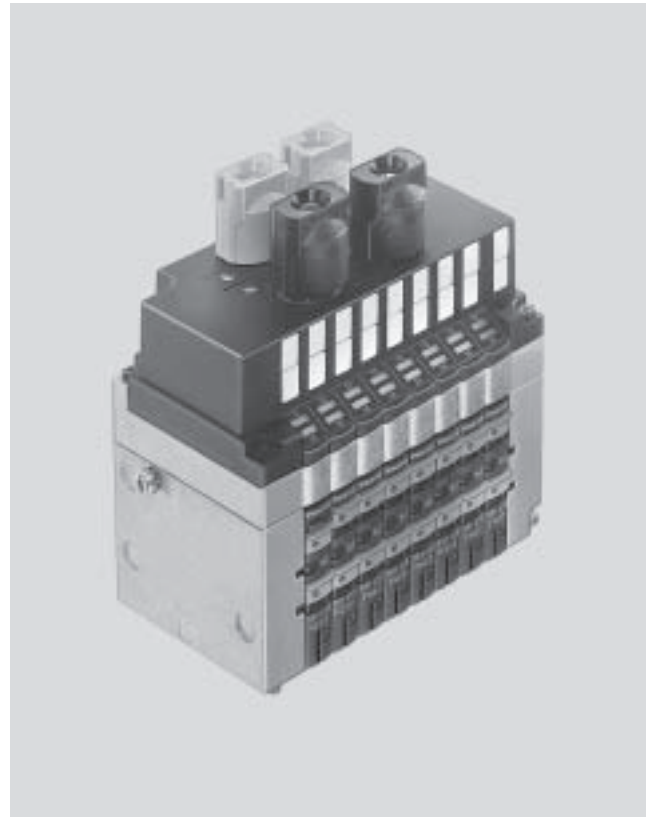

### Application

#### Bus connection

The Interbus loop connection uses “Quick On” technology with one connection each for the incoming and outgoing bus respectively.

-  - Note

It is not possible to connect a CP string extension in this case.

## Fieldbus Direct, CPV-IL

Technical data – Fieldbus node CPV-IL

**FESTO**

General technical data			
Type		CPV10-GE-IL-8	CPV14-GE-IL-4
Part No.		175 406	188 450
CP string extension		No	
Baud rates	[kbps]	500	
Protocol chip		LPC2	
Max. no. of loop stations		63	
Max. distance between 2 loop stations	[m]	20	
Max. loop length	[m]	200	
Max. loop current	[A]	1.8	
Configuration support		Icon for CMD software	
Max. no. of solenoid coils		16	
Max. no. of outputs		0	
Max. no. of inputs		0	
LED diagnostic displays	DIAG	Bus status	
	US	Undervoltage	
	12	Valve status display	
	14	Valve status display	
Device-specific diagnosis		Undervoltage of valves	
Operating voltage	Nominal value	[V DC]	24, reverse polarity protected
	Permissible range	[V]	20 ... 30
	Power failure buffering	[ms]	20
	Residual ripple	[Vss]	4
Current consumption		[mA]	Max. 100
Protection class to EN 60 529			IP65
Approval			CE
Temperature range	Operating	[°C]	-5 ... +50
	Storage	[°C]	-20 ... +70
Materials	Housing		Die-cast aluminium
	Plug cap		Polyamide, glass fibre (Ultramide)
	Seal		Nitrile rubber, Neoprene
Dimensions			→ Info 213 Valve terminal CPV
Weight			→ Info 213
Technical data for valves			→ Info 213

## Fieldbus Direct, CPV-IL

Technical data – Fieldbus node CPV-IL

### Connection and display components

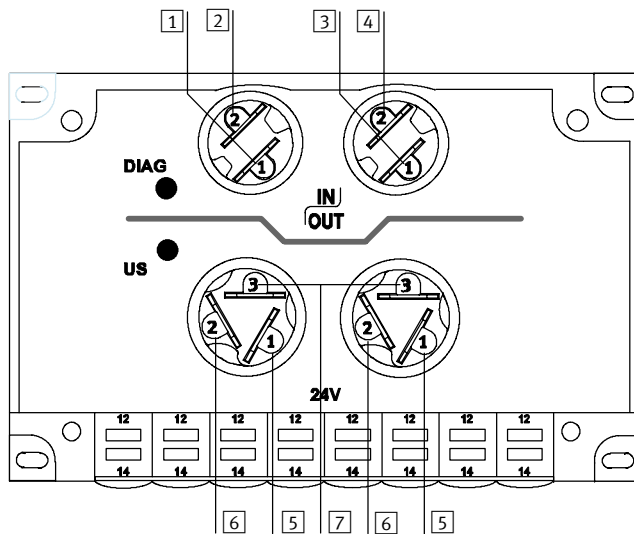

- 1 BUS IN +
- 2 BUS IN -
- 3 BUS OUT +
- 4 BUS IN -
- 5 24 V DC valve supply
- 6 0 V valve supply
- 7 Earth terminal for valve supply

### Power supply



The load supply for the valves is supplied using a separate Quick On connection, with one connection each for the incoming and outgoing supply respectively.

 Type to be discontinued  
Available until 2007

## Fieldbus Direct, CPV-IL

Accessories – Fieldbus node CPV-IL

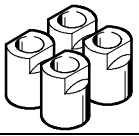
**FESTO**

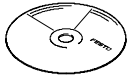
Ordering data				
Designation		Type	Part No.	
Bus and power supply connection				
	Quick On connection set	FBS-IBL-PG11/13	175 485	
User documentation				
	User documentation for CPV Direct, CPV fieldbus node IL	German	P.BE-CP-IL-DE	175 508
		English	P.BE-CP-IL-EN	175 509
		French	P.BE-CP-IL-FR	175 510
		Italian	P.BE-CP-IL-IT	175 511
		Spanish	P.BE-CP-IL-ES	175 512
		Swedish	P.BE-CP-IL-SV	175 513
Software				
	CD-ROM	Valve terminal user documentation (PDF)	P.CD-VALVE-T	183 350
		Utilities	P.CD-VI-UTILITIES-2	533 500

# Fieldbus Direct, CPV-IP

Technical data – Fieldbus node CPV-IP

FESTO

BECKHOFF

CPV fieldbus node for communication between a CPV valve terminal and an IP-Link coupler box. The fieldbus node is used for activation of a CPV valve terminal with 8 valve slices and 16 solenoid coils and for displaying the switching status via LED.

The CPV-... valves are activated using automatic current reduction, which results in less power consumption and heat emission.

The CPV fieldbus node supports the fieldbus protocol IP-Link.

The CPV fieldbus node is available in two sizes, with identical performance characteristics:

- CPV10
- CPV14



## Application

### Bus connection

The bus connection is established using two IP-Link fibre optic cable connectors.

The bus connector plugs (with protection class IP65) facilitate the connection of the incoming and outgoing fibre optic cable (FOC).

### Power supply

The power is supplied via a 4-pin M8 connection (socket). The supply to the internal logic is fully electrically isolated from the supply to the solenoid coils.

The second M8 connection (pin) allows power to be supplied to additional CPV IP-Link valve terminals and other IP-Link modules.

# Fieldbus Direct, CPV-IP

Technical data – Fieldbus node CPV-IP

General technical data			
Type	CPV10-GE-IP-8		CPV14-GE-IP-8
Part No.	534 509		534 507
CP string extension	No		
Fieldbus interface	IP-Link Incoming, outgoing		
Baud rates	[kbps]	2000	
Data model	Compact	16 outputs	
	Complex	24 inputs 24 outputs	
Configuration support	Profibus	GSD file	
	Interbus	Not necessary	
	CANopen	EDS file	
	DeviceNet	EDS file	
Max. no. of solenoid coils	16		
LED diagnostic displays	US	Operating voltage, internal logic	
	UP	Operating voltage, valves	
	RUN	Bus active	
	ERR	Data transmission error	
Device-specific diagnosis	In complex mode: Monitoring of valve undervoltage		
Parameterisation	Via register communication: Setting via watchdog for coils 1 ... 16		
Operating voltage	Nominal value	[V DC]	24, reverse polarity protected
	Permissible range	[V]	20.4 ... 28.8
	Power failure buffering	[ms]	10
	Residual ripple	[Vss]	4
Current consumption	Logic	[mA]	Max. 100
	Valves	Depending on valve type	
Protection class to EN 60 529	IP65		
Approval	CE		
Temperature range	Operating	[°C]	-5 ... +50
	Storage	[°C]	-20 ... +70
Materials	Housing	Die-cast aluminium	
	Plug cap	Polyamide, glass fibre (Ultramide)	
	Seal	Nitrile rubber, Neoprene	
Dimensions	➔ Info 213 Valve terminal CPV		
Weight	➔ Info 213		
Technical data for valves	➔ Info 213		

# Fieldbus Direct, CPV-IP

Technical data – Fieldbus node CPV-IP

## Connection and display components

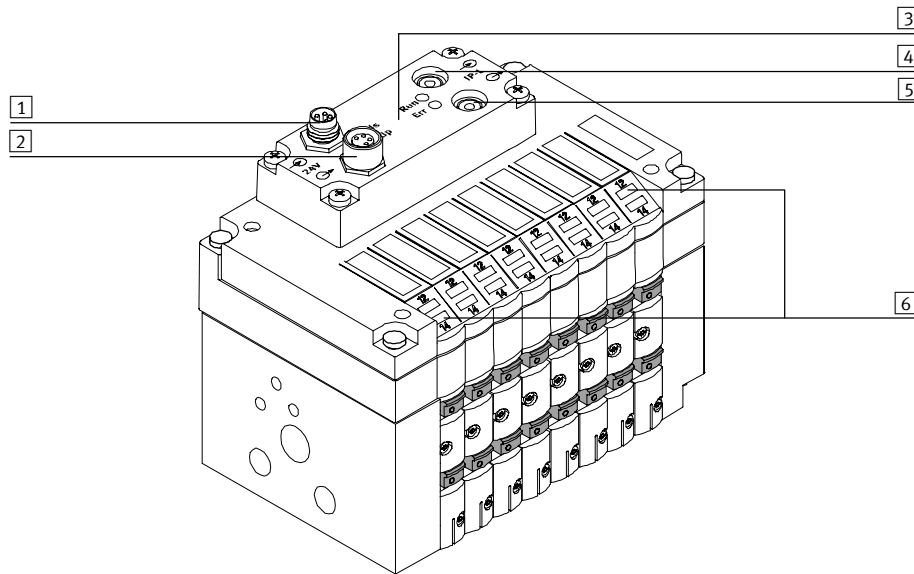

- 1 Connection for power supply, incoming (M8, 4-pin, plug)
- 2 Connection for power supply, outgoing (M8, 4-pin, socket)
- 3 LEDs:
  - US: Operating voltage, electronics (green)
  - UP: Load voltage, valves (green)
  - RUN: Bus active (green)
  - ERR: Error (red)
- 4 Fieldbus connection, incoming (IP-Link fibre optic cable IP65 socket)
- 5 Fieldbus connection, outgoing (IP-Link fibre optic cable IP65 socket)
- 6 LEDs (yellow) for switching status display of CP solenoid coils

Power supply, incoming		
	Pin	Signal
	1	24 V DC operating voltage, electronics (US)
	2	24 V DC load voltage, valves (UP)
	3	0 V electronics (US)
	4	0 V valves (UP)

Power supply, outgoing		
	Pin	Signal
	1	24 V DC operating voltage, electronics (US)
	2	24 V DC load voltage, valves (UP)
	3	0 V electronics (US)
	4	0 V valves (UP)

# Fieldbus Direct, CPV-IP

Technical data – Fieldbus node CPV-IP

## Equipotential bonding

Example of connection with electrical isolation of operating and load voltage with 2 PELV power supply units

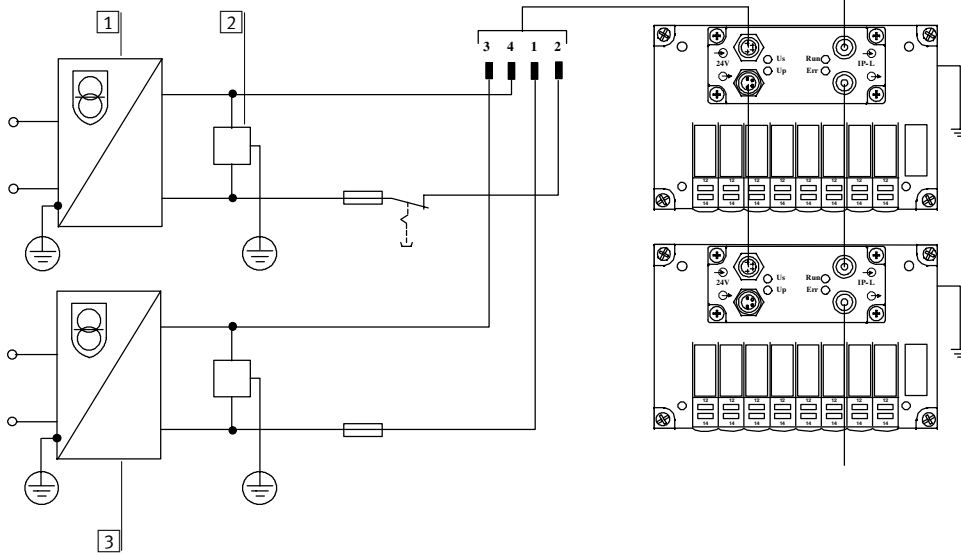

- 1 Power supply unit for load voltage
- 2 Device for isolation monitoring
- 3 Power supply unit for operating voltage

CPV Direct is prepared for the connection with electrical isolation of operating and load voltage.

Example of connection with PELV power supply unit and equipotential bonding

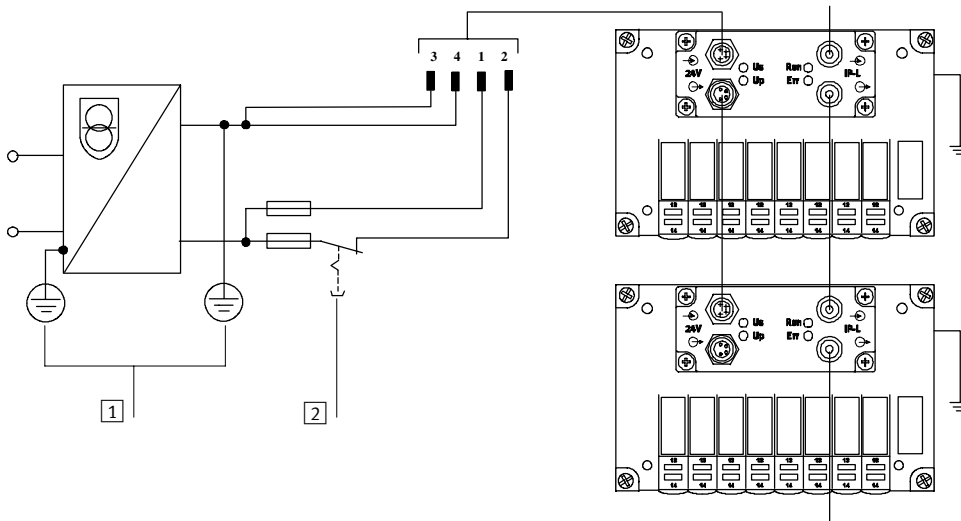

- 1 PE and equipotential bonding
- 2 Load voltage (can be disconnected separately) plus external fuses

The CPV valve terminal has an earth terminal for equipotential bonding on the end plate.

## Ordering data

Designation		Type	Part No.
<b>User documentation</b>			
	User documentation for CPV Direct, CPV fieldbus node IP	German	<b>P.BE-CPV-DI-IP-DE</b>
		English	<b>P.BE-CPV-DI-IP-EN</b>
<b>Software</b>			
	CD-ROM	Valve terminal user documentation (PDF)	<b>P.CD-VALVE-T</b>
		Utilities	<b>P.CD-VI-UTILITIES-2</b>

## Fieldbus Direct, CPV-CC

Technical data – Fieldbus node CPV-CC

FESTO

CC-Link

CPV fieldbus node for communication between a CPV valve terminal and a higher-order master for Control & Communication-Link (CC-Link) from Mitsubishi. The fieldbus node is used for activation of a CPV valve terminal with 8 valve slices and 16 solenoid coils and for displaying the switching status via LED.

The CPV-... valves are activated using automatic current reduction, which results in less power consumption and heat emission. A CP input module with 16 digital inputs can be connected via a serial CP string extension.

The CPV fieldbus node is available in three sizes, with identical performance characteristics:

- CPV10
- CPV14
- CPV18



### Application

#### Bus connection

The bus connection can be selected when ordering and is established by means of:

- a terminal strip with IP20 protection
- a Sub-D plug with IP65 protection from Festo
- a Sub-D plug with IP20 protection from other manufacturers

All connection types have the function of an integrated T-distributor and thus support the connection of an incoming and outgoing bus cable.

The integrated interface with RS 485 transmission technology is designed for the typical CC-Link 3-wire connection technology (in accordance with CLPA CC-Link Spec. V1.11).

#### CC-Link implementation

The CPV fieldbus node supports one station per slave. Cyclic data transmission for the solenoid coils,

digital inputs and status information is conducted using the bit and word ranges (Rx/Ry/RWr/RWw).

# Fieldbus Direct, CPV-CC



Technical data – Fieldbus node CPV-CC

General technical data				
Type		CPV10-GE-CC-8	CPV14-GE-CC-8	CPV18-GE-CC-8
Part No.		197 959	197 967	197 969
CP string extension		Yes 16 inputs (connection of an additional CP valve terminal or CP output module not possible)		
Fieldbus interface		Either: ■ Sub-D, 9-pin socket ■ 5-pin screw terminal strip		
Baud rates	[kbps]	156 ... 10 000 Set using DIL switch		
Addressing range		1 ... 64 Set using DIL switch		
No. of stations per slave		1 station Permanent setting		
Vendor code		0x0177		
Machine type		0x3C		
Type of communication		Cyclic communication		
Configuration support		-		
Max. no. of solenoid coils		16 (Ry)		
Max. no. of outputs		0		
Max. no. of inputs		16 (RWr)		
LED diagnostic displays	RUN	Data communication OK		
	Pow/Err	Operating voltage/CRC error or data communication error		
Device-specific diagnosis		Remote ready		
Parameterisation		Hold/clear by means of DIL switch		
Additional functions		8-bit system status in bit range (Rx)		
Operating voltage	Nominal value	[V DC]	24, reverse polarity protected	
	Permissible range	[V]	20.4 ... 26.4	
	Power failure buffering	[ms]	20	
Current consumption		[mA]	Max. 200 + sensor supply	
Protection class to EN 60 529			IP20, IP65 (Sub-D)	
Approval			CE	
Temperature range	Operating	[°C]	-5 ... +50	
	Storage	[°C]	-20 ... +70	
Materials	Housing		Die-cast aluminium	
	Plug cap		Polyamide, glass fibre (Ultramide)	
	Seal		Nitrile rubber, Neoprene	
Dimensions			➔ Info 213 Valve terminal CPV	
Weight			➔ Info 213	
Technical data for valves			➔ Info 213	

# Fieldbus Direct, CPV-CC

Technical data – Fieldbus node CPV-CC

## Connection and display components

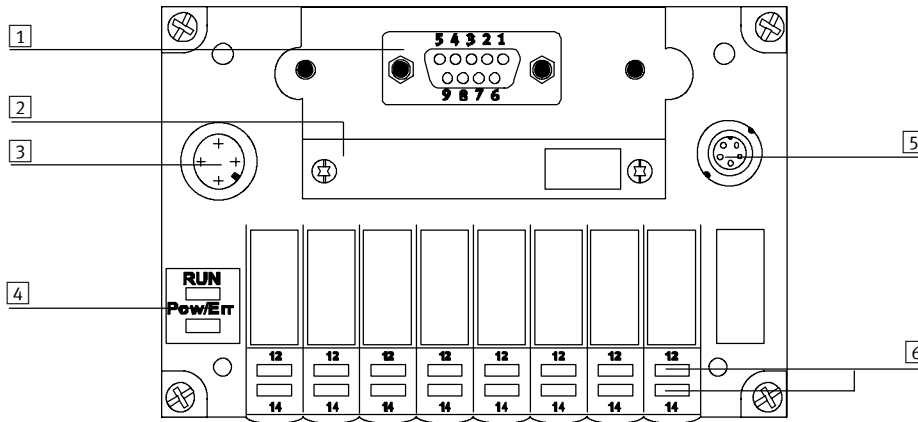

- 1 Fieldbus connection, 9-pin Sub-D socket
- 2 Switch module (removable)
- 3 Connection for voltage supply (4-pin M12 plug, operating voltage for electronics/sensors, load voltage for CP valves)
- 4 LEDs:
  - Data communication (RUN)
  - Operating voltage/error (Pow/Err)
- 5 CP extension connection
- 6 Switching status displays of CPV solenoid coils

## Pin allocation for Sub-D interface (socket view)

	Pin	Signal	Designation
	1	n.c.	Not connected
	2	DA	Data A
	3	DG	Data reference potential
	4	n.c.	Not connected
	5	n.c.	FE via RC combination (not used with CC-Link: connection via R/C combination to FE (1 Mohm/220 nF))
	6	n.c.	Not connected
	7	CAN_H	Data B
	8	n.c.	Not connected
	9	n.c.	Not connected
	Housing	SLD	Screen









## Pin allocation for terminal strip

	Pin	Signal	Designation
	1	FG	Functional earthing/housing
	2	SLD	Screen
	3	DG	Data reference potential
	4	DB	Data B
	5	DA	Data A

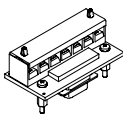
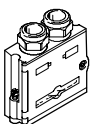
# Fieldbus Direct, CPV-CC

Accessories – Fieldbus node CPV-CC

**FESTO**

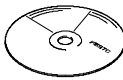
Ordering data				
Designation			Type	Part No.
<b>Power supply</b>				
	Power supply socket, straight		FBSD-GD-7	18 497
			FBSD-GD-9	18 495
	Power supply socket, angled		FBSD-WD-7	18 524
			FBSD-WD-9	18 525
<b>Bus connection Open Style, 5-pin screw terminal strip</b>				
	Bus connection, 5-pin terminal strip for CC-Link		FBA-1-KL-5POL	197 962
	Fieldbus plug, Sub-D connection		FBS-SUB-9-GS-2x4POL-B	532 220
	Mounting screw for standard Sub-D (IP20)		UNC 4-40/M3x5	340 960
<b>Valve terminal connection</b>				
	Connecting cable WS-WD	0.5 m	KVI-CP-1-WS-WD-0,5	178 564
		1 m	KVI-CP-1-WS-WD-1.0	191 892
		2 m	KVI-CP-1-WS-WD-2	163 139
		3 m	KVI-CP-1-WS-WD-3.0	191 893
		5 m	KVI-CP-1-WS-WD-5	163 138
	Connecting cable GS-WD	5 m	KVI-CP-1-GS-WD-5	163 137
		8 m	KVI-CP-1-GS-WD-8	163 136
	Connecting cable GS-GD	2 m, for chain link trunking	KVI-CP-2-GS-GD-2	170 234
		5 m, for chain link trunking	KVI-CP-2-GS-GD-5	170 235
		8 m, for chain link trunking	KVI-CP-2-GS-GD-8	165 616
<b>User documentation</b>				
	User documentation for CPV Direct, CPV fieldbus node CC	German	P.BE-CP-CC-DE	197 963
		English	P.BE-CP-CC-EN	197 964
		Japanese	P.BE-CP-CC-J	197 965
<b>Software</b>				
	CD-ROM	Valve terminal user documentation (PDF)	P.CD-VALVE-T	183 350
		Utilities	P.CD-VI-UTILITIES-2	533 500

Whilst every effort is made to ensure that all dimensions and specifications are correct, any printers' errors not rectified are outside the control of Festo, who cannot be held responsible for same. For Liability and Guarantee conditions, refer to our standard "Conditions of Sale", available on request from your local Festo office. All rights reserved, including translation rights. No part of this publication may be reproduced or transmitted in any form or by any means, electronic, mechanical, photocopying or otherwise, without the prior written permission of Festo AG & Co. KG.

All technical data subject to change according to technical update.



**FESTO**

## 100 % service with 100 % partnership

Welcome to a world of service from Festo. Customer orientation is not just our everyday philosophy – it is our launch pad for the future and the route to success for both our customers and ourselves.

### **Global presence, always close at hand**

- 52 national Festo companies in constant on-line communication
- A presence in almost 176 countries, with a total of 10,500 staff
- Worldwide networking for consistent standards of consultancy, sales and service

### **Personal advice**

- Worldwide support provided by over 1,000 highly-qualified technical consultants

### **Software service**

Electronic catalogue:

Database-supported general catalogue on CD-ROM in 20 languages and a wealth of advantages:

- Fast reliable product search functions
  - Automatic selection of accessories
  - Sizing of pneumatic circuits
  - Calculation and sizing programs with direct links to search functions
- Take advantage of this genuine alternative to our printed catalogue.

Festo Design Tool – provides support for designers using 2D- and 3D-drawings for CAD systems.

FluidDraw – allows fast and easy drafting of circuit diagrams, with direct import of data from the electronic catalogue.

**Info service**

- Full product documentation with detailed technical information
- Attractive regular customer magazines showing useful application examples and new product information
- The latest information available via the Internet at the click of a mouse from <http://www.festo.com>

**Everything from a single source**

- Our catalogue includes over 16,400 products
- All our components are precisely coordinated
- Drives and drive accessories
- Handling and vacuum technology
- Positioning
- Valves and valve accessories
- Valve terminals and bus systems
- Proportional technology
- Compressed air preparation
- Tubing, fittings, mounting accessories
- Sensors and pressure switches
- Pneumatic control technology
- Electronic control technology

**Customer service**

- Telephone advice via hotlines
- Fast on-site service
- Reliable maintenance and complaints service

**Spare parts service**

- Short delivery distances thanks to worldwide local spare-parts service
- Supply from fully stocked Festo warehouses
- Prompt deliveries of Festo components
- For particularly urgent cases, Festo sales offices hold stocks of a good range of almost all accessories and standard components

**Delivery service**

- Fast deliveries of catalogue products ex stock
- Non-standard stroke and special-design cylinder production (SMS) in 28 countries
- Fully-automated Customer Service Center (production and logistics) in St. Ingbert-Rohrbach, Germany
- Customer Service Center handles over 7,400 orders comprising 16,000 items every day
- Daily movement of 6,500 crates weighing a total of 50,000 kg
- Direct deliveries to customers throughout Europe



# Festo automation components

## Important components in our product range

### Compressed air preparation

- D series service units
- MS series service units



### Control technology

- Individual valve CPE
- Valve terminal CPV
- Modular valve terminal MPA and electrical terminal CPX
- Smart Positioning Controller SPC200
- Controller FEC Standard FC640



### Long linear movement

- Rodless cylinder DGPL
- Electric toothed-belt drive DGE
- Standard cylinder DNC and DSNU
- Compact cylinder ADVU



### Short linear movement

- Linear module HMP
- Guided drive DFM
- Mini slide SLT
- Flat slide SLG
- Linear module HMPL
- Short-stroke cylinder ADVC



### Rotary movement

- Rotary drive DRQD
- Swivel module DSM
- Swivel/linear module DSL



### Gripping, mechanical ...

- Precision gripper HGPP
- Micro gripper HGWM
- Three-point gripper HGD



### ... or with vacuum

- Suction gripper ESG
- Vacuum generator VADMI
- Vacuum generator VN



### Connecting and installing

- Basic elements
- Screw connectors
- Couplings
- Fittings and restrictors
- Tubing























### Checking, counting, sorting

- Checkbox family



Further products and details: <http://catalog.festo.com> or consult your Festo technical advisor.

# Pneumatic Pictograms

	Stroke length		Service
	Flow rate		Repair service
	Voltage		Worldwide service
	Force		Hotline
	Pressure		Collection facility
	Temperature		Delivery time
	Diameter		In stock
	Vacuum		Note
	Width		Type discontinued
			New
			Spare parts service