

MDOB160128DV-WS	160 x 128	OLED Module
Specification		
Version: 1	Date: 23/10/2021	
Revision		
1	21/10/2021	First Issue

Display Features			Box Quantity	Weight / Display
Resolution	160 x 128			
Appearance	White on Black			
Logic Voltage	3V			
Interface	SPI			
Module Size	34.90 x 57.80 x 5.36mm			
Operating Temperature	-40°C ~ +80°C			
Construction	COB			

* - For full design functionality, please use this specification in conjunction with the SH1108 specification. (Provided Separately)

Display Accessories	
Part Number	Description

Optional Variants	
Appearance	Voltage
Yellow on Black	



General Specification

The Features is described as follow:

- Module dimension: 34.90 × 57.80 × 5.36 Max.mm
- Active area: 28.908 × 39.34 mm
- Dot Matrix: 160 x 128
- Pixel size: 0.206 × 0.226 mm
- Pixel pitch: 0.226 × 0.246 mm
- Display Mode: Passive Matrix
- Duty: 1/128 Duty
- Display Color: White
- IC: SH1108
- Interface: 4-line SPI
- Size: 1.92 inch



Interface Pin Function

No.	Symbol	Function
1	GND	Ground.
2	VCC	Power supply pin for logic.
3	D0	When the serial interface is selected, then D0 serves as the serial clock input pad (SCL) and D1 serves as the serial data input pad (SI).
4	D1	
5	RES#	This is a reset signal input pad. When RES is set to “L”, the settings are initialized. The reset operation is performed by the RES signal level.
6	D/C#	This is the Data/Command control pad that determines whether the data bits are data or a command. D/C = “H”: the inputs at D0 and D1 are treated as display data. D/C = “L”: the inputs at D0 and D1 are transferred to the command registers.
7	CS#	This pad is the chip select input. When CS = “L”, then the chip select becomes active, and data command I/O is enabled.



Contour Drawing & Block Diagram

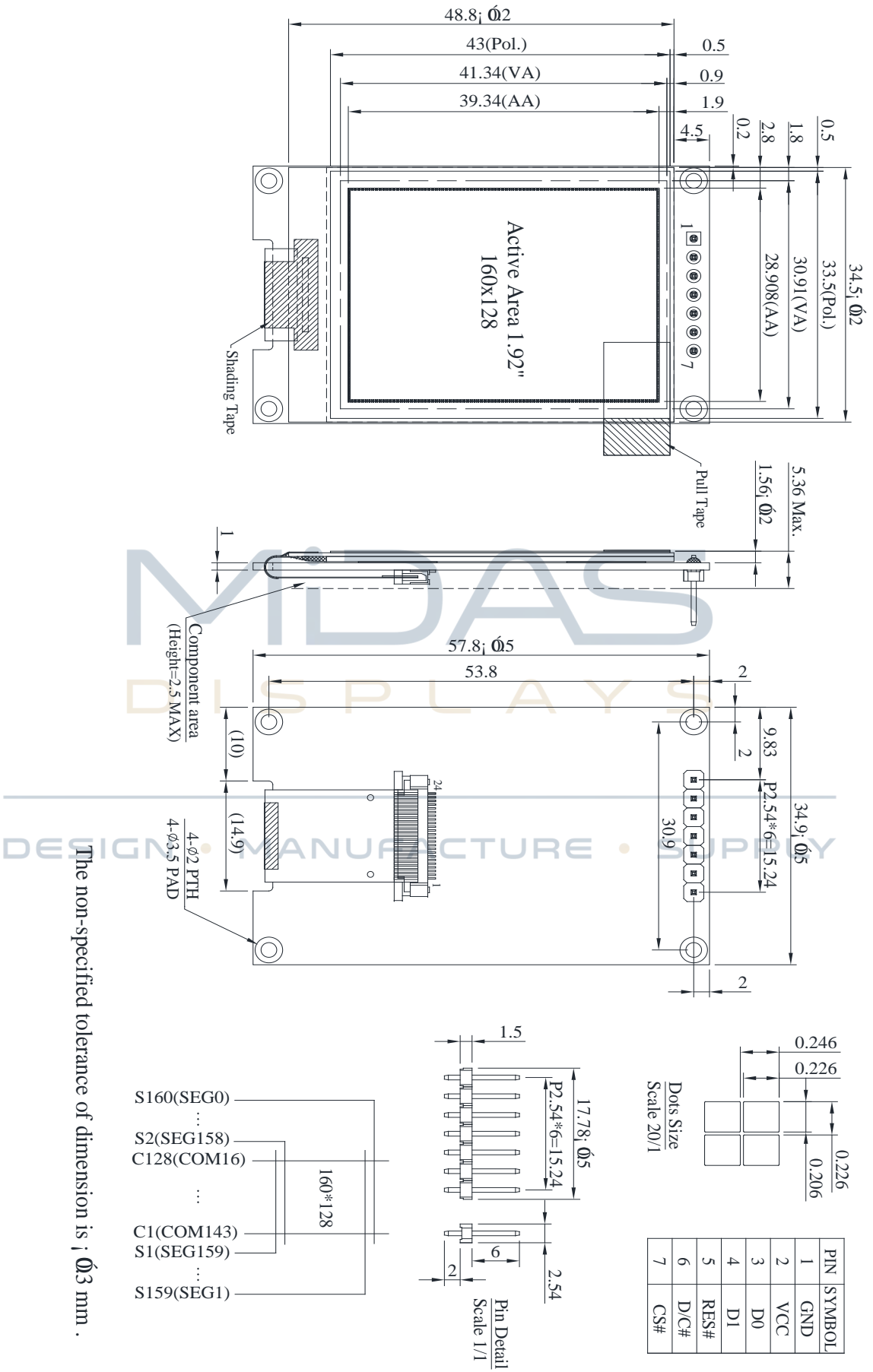

The non-specified tolerance of dimension is ± 0.3 mm.

1. Application recommendations

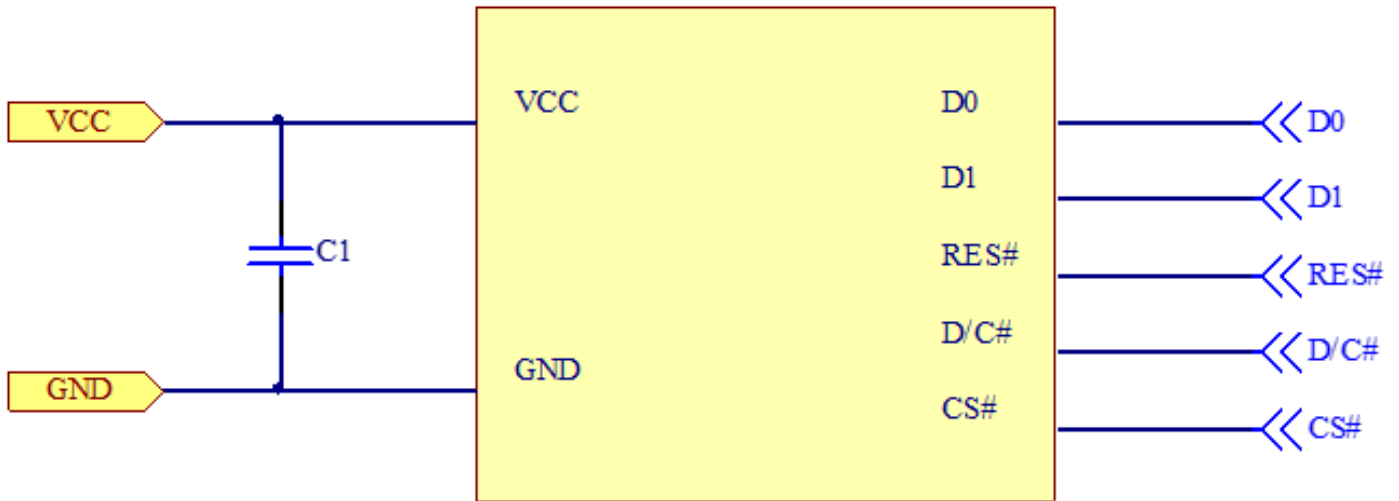

FIELD
DISPLAYS

Recommended components:

C1 : 4.7uF

DESIGN • MANUFACTURE • SUPPLY

Note: The capacitor value is recommended value. Select appropriate value against module application.



Absolute Maximum Ratings

Parameter	Symbol	Min	Max	Unit	Notes
Supply Voltage for Logic	VCC	-0.3	3.6	V	1, 2
Operating Temperature	TOP	-40	+80	°C	-
Storage Temperature	TSTG	-40	+85	°C	-

Note 1: All the above voltages are on the basis of "GND = 0V".

Note 2: When this module is used beyond the above absolute maximum ratings, permanent breakage of the module may occur. Also, for normal operations, it is desirable to use this module under the conditions according to Section 6 "Electrical Characteristics". If this module is used beyond these conditions, malfunctioning of the module can occur and the reliability of the module may deteriorate.

Electrical Characteristics

1. DC Electrical Characteristics

Item	Symbol	Condition	Min	Typ	Max	Unit
Supply Voltage for Logic	VCC	—	1.65	3.0	3.3	V
High Level Input	VIH	—	0.8×VCC	—	VCC	V
Low Level Input	VIL	—	GND	—	0.2×VCC	V
High Level Output	VOH	—	0.8×VCC	—	VCC	V
Low Level Output	VOL	—	GND	—	0.2×VCC	V
50% Check Board operating Current	ICC	VCC =3V	—	100	200	mA

2. Initial code

```
void OLED_INIT (){  
  
    WriteCommand(0xAE); // Display OFF  
  
    WriteCommand(0x20); // Set Memory addressing mode  
  
    WriteCommand(0x81); // Set contrast control  
    WriteCommand(0x0F);  
  
    WriteCommand(0xA0); // Segment remap  
  
    WriteCommand(0xA6); // Normal display  
  
    WriteCommand(0xA9); // Set Display Resolution  
    WriteCommand(0x02); // 160*128  
  
    WriteCommand(0xAD); // Set DC-DC setting  
    WriteCommand(0x80); // DC-DC is disable.  
  
    WriteCommand(0xC0); // Set Common scan direction  
    WriteCommand(0xD5); // Divide Ratio/Oscillator Frequency Mode Set  
    WriteCommand(0xF1);  
  
    WriteCommand(0xD9); // Set Dis-charge/Pre-charge Period  
    WriteCommand(0x1F);  
  
    WriteCommand(0xDB); // Set Vcomh voltage  
    WriteCommand(0x2B);  
  
    WriteCommand(0xDC); // Set VSEGM Deselect Level  
    WriteCommand(0x35);  
  
    WriteCommand(0x30); // Set Discharge VSL Level  
  
    WriteCommand(0xAF); // Display ON  
  
}
```

Note 1: Initial code is for reference only. Please make the best adjustment with the OLED module.

Note 2: Command: Set Contrast Control (0x81) , This command sets the Contrast Setting of the display. The chip has 256 contrast steps from 00h to FFh. The segment output current increases as the contrast step value increases. The segment current increases, the OLED brightness increases.



Optical Characteristics

Item	Symbol	Condition	Min	Typ	Max	Unit
View Angle	(V) θ	—	160	—	—	deg
	(H) ϕ	—	160	—	—	deg
Contrast Ratio	CR	Dark	10,000:1	—	—	—
Response Time	T rise	—	—	10	—	μ s
	T fall	—	—	10	—	μ s
Display with 50% check Board Brightness			80	100	—	cd/m ²
CIE _x (White)		(CIE1931)	0.26	0.28	0.30	—
CIE _y (White)		(CIE1931)	0.30	0.32	0.34	—

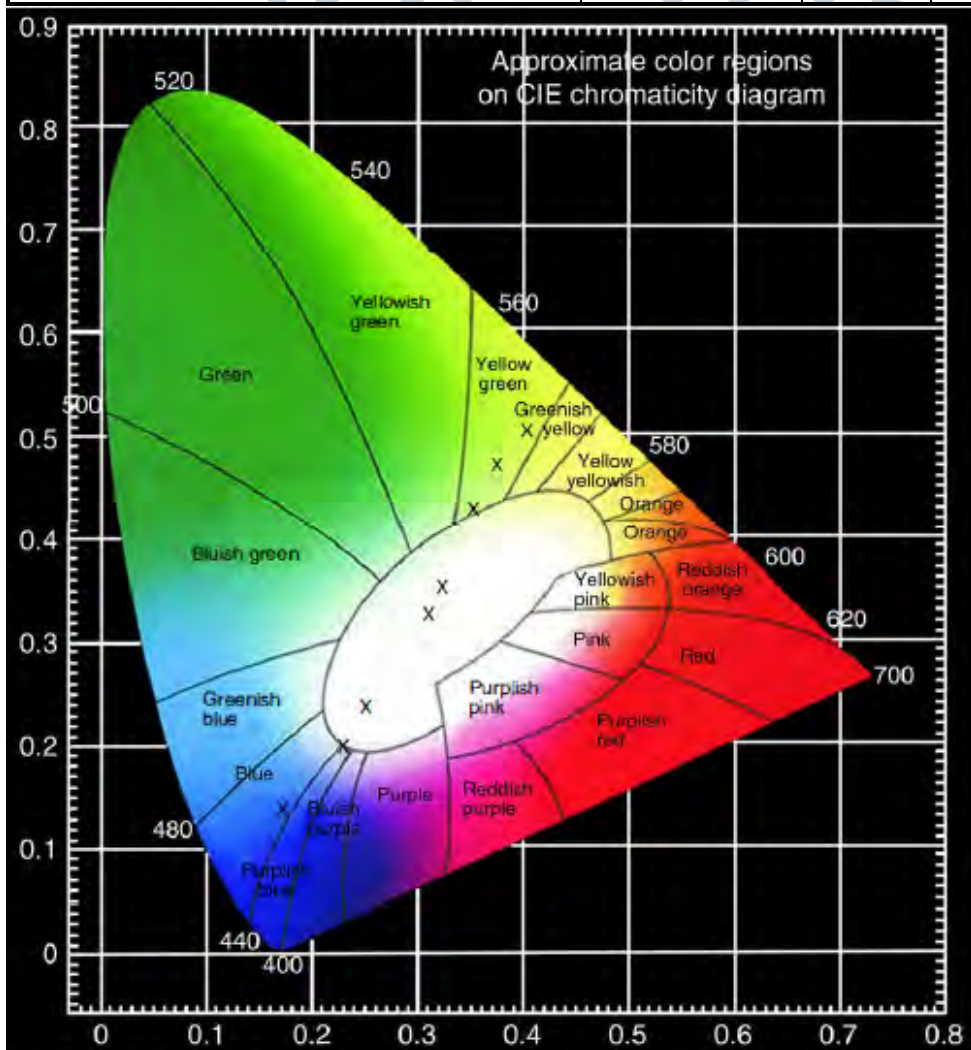

OLED Lifetime

ITEM	Conditions	Min	Typ	Remark
Operating Life Time	Ta=25°C / Initial 50% check board brightness Typical Value	20,000 Hrs	-	Note

Notes:

1. Life time is defined the amount of time when the luminance has decayed to <50% of the initial value.
2. This analysis method uses life data obtained under accelerated conditions to extrapolate an estimated probability density function (*pdf*) for the product under normal use conditions.
3. Screen saving mode will extend OLED lifetime.

MIDAS
DISPLAYS

DESIGN • MANUFACTURE • SUPPLY



Reliability

Content of Reliability Test

Environmental Test			
Test Item	Content of Test	Test Condition	Applicable Standard
High Temperature storage	Endurance test applying the high storage temperature for a long time.	85°C 240hrs	—
Low Temperature storage	Endurance test applying the low storage temperature for a long time.	-40°C 240hrs	—
High Temperature Operation	Endurance test applying the electric stress (Voltage & Current) and the thermal stress to the element for a long time.	80°C 240hrs	—
Low Temperature Operation	Endurance test applying the electric stress under low temperature for a long time.	-40°C 240hrs	—
High Temperature/ Humidity Storage	Endurance test applying the high temperature and high humidity storage for a long time.	60°C,90%RH 240hrs	—
High Temperature/ Humidity Operation	Endurance test applying the high temperature and high humidity Operation for a long time.	60°C,90%RH 120hrs	—
Temperature Cycle	Endurance test applying the low and high temperature cycle. -40°C 25°C 80°C 30min 5min 30min	-40°C /80°C 30 cycles	—
Mechanical Test			
Vibration test	Endurance test applying the vibration during transportation and using.	Frequency:10~55Hz amplitude:1.5mm Time:0.5hrs/axis Test axis:X,Y,Z	—
Others			
Static electricity test	Endurance test applying the electric stress to the finished product housing.	Air Discharge model ±4kv,10 times	—

*** Supply voltage for OLED system =Operating voltage at 25°C



Test and measurement conditions

1. All measurements shall not be started until the specimens attain to temperature stability. After the completion of the described reliability test, the samples were left at room temperature for 2 hrs prior to conducting the failure test at $23\pm 5^{\circ}\text{C}$; $55\pm 15\%$ RH.
2. All-pixels on/off exchange is used as operation test pattern.
3. The degradation of Polarizer are ignored for High Temperature storage, High Temperature/ Humidity Storage, Temperature Cycle

Evaluation criteria

1. The function test is OK.
2. No observable defects.
3. Luminance: $> 50\%$ of initial value.
4. Current consumption: within $\pm 50\%$ of initial value.

APPENDIX:

RESIDUE IMAGE

Because the pixels are lighted in different time, the luminance of active pixels may reduce or differ from inactive pixels. Therefore, the residue image will occur. To avoid the residue image, every pixel needs to be lighted up uniformly.

MIDAS
DISPLAYS

DESIGN • MANUFACTURE • SUPPLY



Inspection specification

Inspection Standard:

MIL-STD-105E table normal inspection single sample level II.

Definition

- 1 Major defect : The defect that greatly affect the usability of product.
- 2 Minor defect : The other defects, such as cosmetic defects, etc.

Definition of inspection zone:

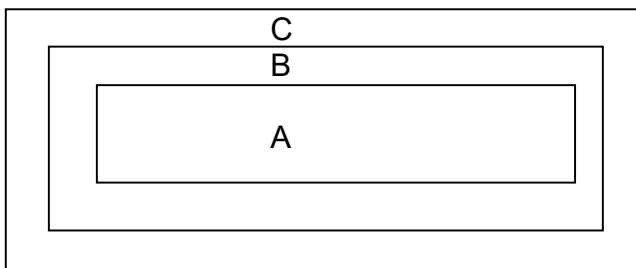

Zone A: Active Area

Zone B: Viewing Area except Zone A

Zone C: Outside Viewing Area

Note: As a general rule, visual defects in Zone C are permissible, when it is no trouble of quality and assembly to customer`s product.

Inspection Methods



- 1 The general inspection : Under fluorescent light illumination: 750~1500 Lux, about 30cm viewing distance, within 45° viewing angle, under 25±5°C.
- 2 The luminance and color coordinate inspection : By SR-3 or BM-7 or the equal equipments, in the dark room, under 25±5°C.

NO	Item	Criterion	AQL
01	Electrical Testing	1.1 Missing vertical, horizontal segment, segment contrast defect. 1.2 Missing character , dot or icon. 1.3 Display malfunction. 1.4 No function or no display. 1.5 Current consumption exceeds product specifications. 1.6 OLED viewing angle defect. 1.7 Mixed product types. 1.8 Contrast defect.	0.65
02	Black or white spots on OLED (display only)	2.1 White and black spots on display $\leq 0.25\text{mm}$, no more than three white or black spots present. 2.2 Densely spaced: No more than two spots or lines within 3mm.	2.5

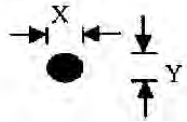
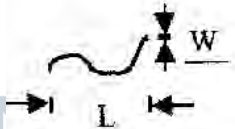

NO	Item	Criterion	AQL																			
03	OLED black spots, white spots, contamination (non-display)	<p>3.1 Round type : As following drawing $\Phi = (x + y) / 2$</p>  <table border="1"> <thead> <tr> <th>SIZE</th> <th>Acceptable QTY</th> <th>Zone</th> </tr> </thead> <tbody> <tr> <td>$\Phi \leq 0.10$</td> <td>ignore</td> <td>A+ B,</td> </tr> <tr> <td>$0.10 < \Phi \leq 0.20$</td> <td>2</td> <td>A+ B</td> </tr> <tr> <td>$0.20 < \Phi \leq 0.25$</td> <td>1</td> <td>A+ B</td> </tr> <tr> <td>$0.25 < \Phi$</td> <td>0</td> <td>A+ B</td> </tr> </tbody> </table>	SIZE	Acceptable QTY	Zone	$\Phi \leq 0.10$	ignore	A+ B,	$0.10 < \Phi \leq 0.20$	2	A+ B	$0.20 < \Phi \leq 0.25$	1	A+ B	$0.25 < \Phi$	0	A+ B	2.5				
	SIZE	Acceptable QTY	Zone																			
$\Phi \leq 0.10$	ignore	A+ B,																				
$0.10 < \Phi \leq 0.20$	2	A+ B																				
$0.20 < \Phi \leq 0.25$	1	A+ B																				
$0.25 < \Phi$	0	A+ B																				
		<p>3.2 Line type : (As following drawing)</p>  <table border="1"> <thead> <tr> <th>Length</th> <th>Width</th> <th>Acceptable QTY</th> <th>Zone</th> </tr> </thead> <tbody> <tr> <td>---</td> <td>$W \leq 0.02$</td> <td>ignore</td> <td>A+B</td> </tr> <tr> <td>$L \leq 3.0$</td> <td>$0.02 < W \leq 0.03$</td> <td rowspan="2">2</td> <td>A+B</td> </tr> <tr> <td>$L \leq 2.5$</td> <td>$0.03 < W \leq 0.05$</td> <td>A+B</td> </tr> <tr> <td>---</td> <td>$0.05 < W$</td> <td>As round type</td> <td></td> </tr> </tbody> </table>	Length	Width	Acceptable QTY	Zone	---	$W \leq 0.02$	ignore	A+B	$L \leq 3.0$	$0.02 < W \leq 0.03$	2	A+B	$L \leq 2.5$	$0.03 < W \leq 0.05$	A+B	---	$0.05 < W$	As round type		2.5
Length	Width	Acceptable QTY	Zone																			
---	$W \leq 0.02$	ignore	A+B																			
$L \leq 3.0$	$0.02 < W \leq 0.03$	2	A+B																			
$L \leq 2.5$	$0.03 < W \leq 0.05$		A+B																			
---	$0.05 < W$	As round type																				
04	Polarizer bubbles /Dent	<p>4.1 If bubbles are visible, judge using black spot specifications, not easy to find, must check in specify direction.</p> <table border="1"> <thead> <tr> <th>Size Φ</th> <th>Acceptable QTY</th> <th>Zone</th> </tr> </thead> <tbody> <tr> <td>$\Phi \leq 0.20$</td> <td>ignore</td> <td>A+B</td> </tr> <tr> <td>$0.20 < \Phi \leq 0.50$</td> <td>3</td> <td>A+B</td> </tr> <tr> <td>$0.50 < \Phi \leq 1.00$</td> <td>2</td> <td>A+B</td> </tr> <tr> <td>$1.00 < \Phi$</td> <td>0</td> <td>A+B</td> </tr> <tr> <td>Total QTY</td> <td>3</td> <td></td> </tr> </tbody> </table> <p>4.2 The polarizer dent follows this specification.</p>	Size Φ	Acceptable QTY	Zone	$\Phi \leq 0.20$	ignore	A+B	$0.20 < \Phi \leq 0.50$	3	A+B	$0.50 < \Phi \leq 1.00$	2	A+B	$1.00 < \Phi$	0	A+B	Total QTY	3		2.5	
Size Φ	Acceptable QTY	Zone																				
$\Phi \leq 0.20$	ignore	A+B																				
$0.20 < \Phi \leq 0.50$	3	A+B																				
$0.50 < \Phi \leq 1.00$	2	A+B																				
$1.00 < \Phi$	0	A+B																				
Total QTY	3																					
05	Scratches	Follow NO.3 OLED black spots, white spots, contamination.																				

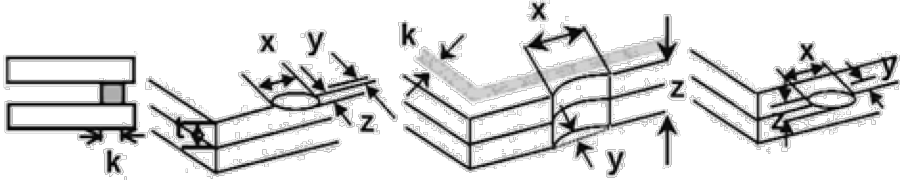

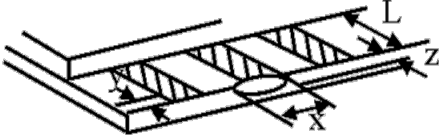
NO	Item	Criterion	AQL									
06	Chipped glass	<p>Symbols Define: x: Chip length y: Chip width z: Chip thickness k: Seal width t: Glass thickness a: OLED side length L: Electrode pad length: 6.1 General glass chip : 6.1.1 Chip on panel surface and crack between panels:</p>  <table border="1" data-bbox="427 757 1315 882"> <tr> <td>z: Chip thickness</td> <td>y: Chip width</td> <td>x: Chip length</td> </tr> <tr> <td>$Z \leq 1/2t$</td> <td>Not over viewing area</td> <td>$x \leq 1/8a$</td> </tr> <tr> <td>$1/2t < z \leq 2t$</td> <td>Not exceed 1/3k</td> <td>$x \leq 1/8a$</td> </tr> </table> <p>⊙ If there are 2 or more chips, x is total length of each chip.</p>	z: Chip thickness	y: Chip width	x: Chip length	$Z \leq 1/2t$	Not over viewing area	$x \leq 1/8a$	$1/2t < z \leq 2t$	Not exceed 1/3k	$x \leq 1/8a$	2.5
	z: Chip thickness	y: Chip width	x: Chip length									
$Z \leq 1/2t$	Not over viewing area	$x \leq 1/8a$										
$1/2t < z \leq 2t$	Not exceed 1/3k	$x \leq 1/8a$										
	<p>6.1.2 Corner crack:</p>  <table border="1" data-bbox="427 1189 1334 1314"> <tr> <td>z: Chip thickness</td> <td>y: Chip width</td> <td>x: Chip length</td> </tr> <tr> <td>$Z \leq 1/2t$</td> <td>Not over viewing area</td> <td>$x \leq 1/8a$</td> </tr> <tr> <td>$1/2t < z \leq 2t$</td> <td>Not exceed 1/3k</td> <td>$x \leq 1/8a$</td> </tr> </table> <p>⊙ If there are 2 or more chips, x is the total length of each chip.</p>	z: Chip thickness	y: Chip width	x: Chip length	$Z \leq 1/2t$	Not over viewing area	$x \leq 1/8a$	$1/2t < z \leq 2t$	Not exceed 1/3k	$x \leq 1/8a$	2.5	
z: Chip thickness	y: Chip width	x: Chip length										
$Z \leq 1/2t$	Not over viewing area	$x \leq 1/8a$										
$1/2t < z \leq 2t$	Not exceed 1/3k	$x \leq 1/8a$										
	Glass crack	<p>Symbols : x: Chip length y: Chip width z: Chip thickness k: Seal width t: Glass thickness a: OLED side length L: Electrode pad length 6.2 Protrusion over terminal : 6.2.1 Chip on electrode pad :</p>  <table border="1" data-bbox="427 1742 1315 1823"> <tr> <td>y: Chip width</td> <td>x: Chip length</td> <td>z: Chip thickness</td> </tr> <tr> <td>$y \leq 0.5\text{mm}$</td> <td>$x \leq 1/8a$</td> <td>$0 < z \leq t$</td> </tr> </table>	y: Chip width	x: Chip length	z: Chip thickness	$y \leq 0.5\text{mm}$	$x \leq 1/8a$	$0 < z \leq t$	2.5			
y: Chip width	x: Chip length	z: Chip thickness										
$y \leq 0.5\text{mm}$	$x \leq 1/8a$	$0 < z \leq t$										

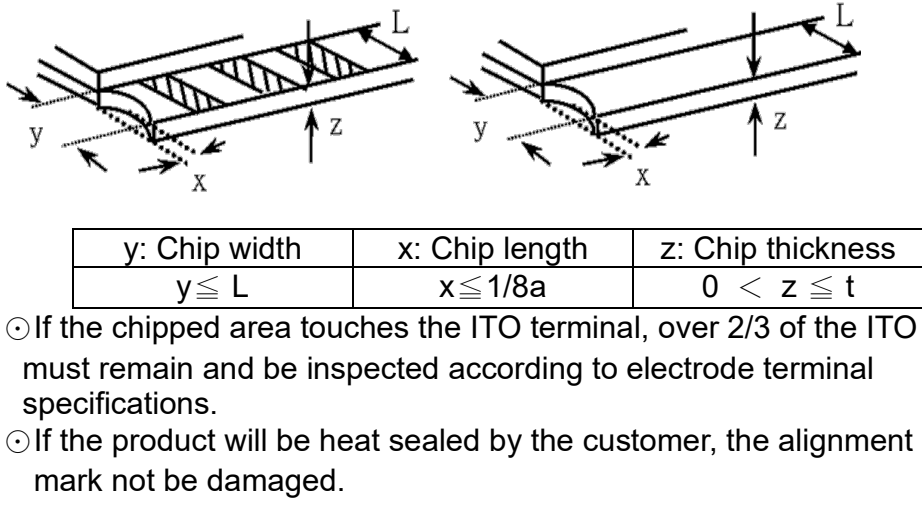
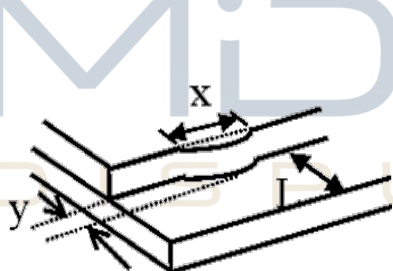

NO	Item	Criterion	AQL										
06	Glass crack	<p>6.2.2 Non-conductive portion:</p>  <table border="1" data-bbox="496 573 1353 651"> <tr> <td>y: Chip width</td> <td>x: Chip length</td> <td>z: Chip thickness</td> </tr> <tr> <td>$y \leq L$</td> <td>$x \leq 1/8a$</td> <td>$0 < z \leq t$</td> </tr> </table> <p>⊙ If the chipped area touches the ITO terminal, over 2/3 of the ITO must remain and be inspected according to electrode terminal specifications.</p> <p>⊙ If the product will be heat sealed by the customer, the alignment mark not be damaged.</p> <p>6.2.3 Substrate protuberance and internal crack.</p>  <table border="1" data-bbox="826 929 1321 1008"> <tr> <td>y: width</td> <td>x: length</td> </tr> <tr> <td>$y \leq 1/3L$</td> <td>$x \leq a$</td> </tr> </table>	y: Chip width	x: Chip length	z: Chip thickness	$y \leq L$	$x \leq 1/8a$	$0 < z \leq t$	y: width	x: length	$y \leq 1/3L$	$x \leq a$	2.5
y: Chip width	x: Chip length	z: Chip thickness											
$y \leq L$	$x \leq 1/8a$	$0 < z \leq t$											
y: width	x: length												
$y \leq 1/3L$	$x \leq a$												
07	Cracked glass	The OLED with extensive crack is not acceptable.	2.5										
08	Backlight elements	<p>8.1 Illumination source flickers when lit.</p> <p>8.2 Spots or scratched that appear when lit must be judged. Using OLED spot, lines and contamination standards.</p> <p>8.3 Backlight doesn't light or color wrong.</p>	0.65 2.5 0.65										
09	Bezel	<p>9.1 Bezel may not have rust, be deformed or have fingerprints, stains or other contamination.</p> <p>9.2 Bezel must comply with job specifications.</p>	2.5 0.65										



NO	Item	Criterion	AQL
10	PCB , COB	10.1 COB seal may not have pinholes larger than 0.2mm or contamination.	2.5
		10.2 COB seal surface may not have pinholes through to the IC.	2.5
		10.3 The height of the COB should not exceed the height indicated in the assembly diagram.	0.65
		10.4 There may not be more than 2mm of sealant outside the seal area on the PCB. And there should be no more than three places.	2.5
		10.5 No oxidation or contamination PCB terminals.	2.5
		10.6 Parts on PCB must be the same as on the production characteristic chart. There should be no wrong parts, missing parts or excess parts.	0.65
		10.7 The jumper on the PCB should conform to the product characteristic chart.	0.65
		10.8 If solder gets on bezel tab pads, OLED pad, zebra pad or screw hold pad, make sure it is smoothed down.	2.5
11	Soldering	11.1 No un-melted solder paste may be present on the PCB.	2.5
		11.2 No cold solder joints, missing solder connections, oxidation or icicle.	2.5
		11.3 No residue or solder balls on PCB.	2.5
		11.4 No short circuits in components on PCB.	0.65
12	General appearance	12.1 No oxidation, contamination, curves or, bends on interface Pin (OLB) of TCP.	2.5
		12.2 No cracks on interface pin (OLB) of TCP.	0.65
		12.3 No contamination, solder residue or solder balls on product.	2.5
		12.4 The IC on the TCP may not be damaged, circuits.	2.5
		12.5 The uppermost edge of the protective strip on the interface pin must be present or look as if it cause the interface pin to sever.	2.5
		12.6 The residual rosin or tin oil of soldering (component or chip component) is not burned into brown or black color.	2.5
		12.7 Sealant on top of the ITO circuit has not hardened.	2.5
		12.8 Pin type must match type in specification sheet.	0.65
		12.9 OLED pin loose or missing pins.	0.65
		12.10 Product packaging must the same as specified on packaging specification sheet.	0.65
		12.11 Product dimension and structure must conform to product specification sheet.	0.65

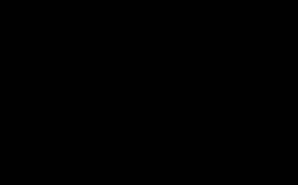
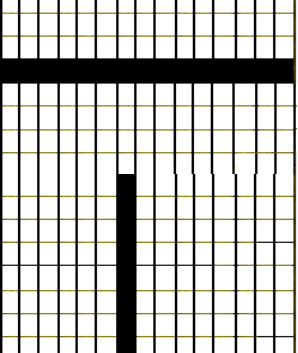
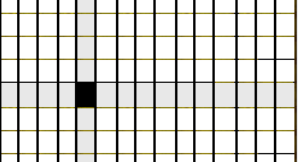
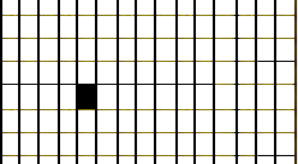
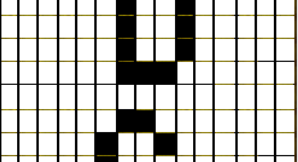
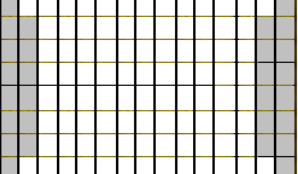
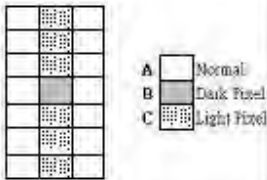

Check Item	Classification	Criteria
No Display	Major	
Missing Line	Major	
Pixel Short	Major	
Darker Short	Major	
Wrong Display	Major	
Un-uniform B/A x 100% < 70% A/C x 100% < 70%	Major	 <div data-bbox="991 1630 1284 1839">  <p>A Normal B Dark Pixel C Light Pixel</p> </div>



Precautions in use of OLED Modules

Modules

- (1) Avoid applying excessive shocks to module or making any alterations or modifications to it.
- (2) Don't make extra holes on the printed circuit board, change the components or modify its shape of OLED display module.
- (3) Don't disassemble the OLED display module.
- (4) Do not apply input signals while the logic power is off.
- (5) Don't operate it above the absolute maximum rating.
- (6) Don't drop, bend or twist OLED display module.
- (7) Soldering: only to the I/O terminals.
- (8) Hot-Bar FPC soldering condition: 280~350C, less than 5 seconds.
- (9) Midas has the right to change the passive components (Resistors, capacitors and other passive components will have different appearance and color caused by the different supplier.) and change the PCB Rev. (In order to satisfy the supplying stability, management optimization and the best product performance...etc, under the premise of not affecting the electrical characteristics and external dimensions, Midas have the right to modify the version.)
- (10) Midas has the right to upgrade or modify the product function.
- (11) For COG & COF structure OLED products, customers should reserve VCC (VPP) adjustment function or software update function when designing OLED supporting circuit. (The progress of OLED light-emitting materials will increase the conversion efficiency and the brightness. The brightness can be adjusted if necessary)..

1. Handling Precautions

- (1) Since the display panel is being made of glass, do not apply mechanical impacts such as dropping from a high position.
- (2) If the display panel is broken by some accident and the internal organic substance leaks out, be careful not to inhale nor lick the organic substance.
- (3) If pressure is applied to the display surface or its neighborhood of the OLED display module, the cell structure may be damaged. So, be careful not to apply pressure to these sections.
- (4) The polarizer covering the surface of the OLED display module is soft and easily scratched.
- (5) When the surface of the polarizer of the OLED display module has soil, clean the surface. It takes advantage by using following adhesion tape.
 - * Scotch Mending Tape No. 810 or an equivalentNever try to breathe upon the soiled surface nor wipe the surface using cloth containing solvent such as ethyl alcohol, since the surface of the polarizer will become cloudy. Also, pay attention that the following liquid and solvent may spoil the polarizer:
 - * Water
 - * Ketone
 - * Aromatic Solvents
- (6) Protection film is being applied to the surface of the display panel and removes the protection film before assembling it. At this time, if the OLED display module has been stored for a long period of time, residue adhesive material of the protection film may remain on the surface of the display panel after removed of the film. In such case, remove the residue material by the method introduced in the above Section 5.
- (7) Do not touch the following sections whenever possible while handling the OLED display modules.
 - * Pins and electrodes
 - * Pattern layouts such as the TCP & FPC
- (8) Hold OLED display module very carefully when placing OLED display module into the



System housing. Do not apply excessive stress or pressure to OLED display module. And, do not over bend the film with electrode pattern layouts. These stresses will influence the display performance. Also, secure sufficient rigidity for the outer cases.

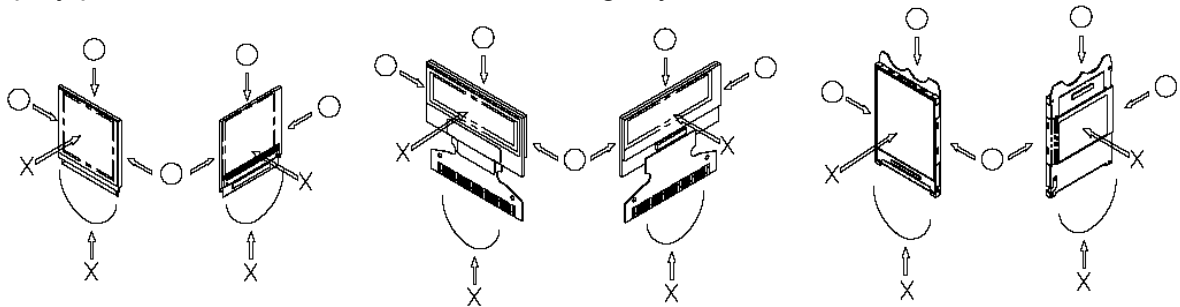

- (9) Do not apply stress to the LSI chips and the surrounding molded sections.
- (10) Pay sufficient attention to the working environments when handing OLED display modules to prevent occurrence of element breakage accidents by static electricity.
 - * Be sure to make human body grounding when handling OLED display modules.
 - * Be sure to ground tools to use or assembly such as soldering irons.
 - * To suppress generation of static electricity, avoid carrying out assembly work under dry environments.
 - * Protective film is being applied to the surface of the display panel of the OLED display module. Be careful since static electricity may be generated when exfoliating the protective film.

2. Storage Precautions

- (1) When storing OLED display modules, put them in static electricity preventive bags to avoid be directly exposed to sun or lights of fluorescent lamps. And, also, place in the temperature $25\pm 5^{\circ}\text{C}$ and Humidity below 65% RH. (We recommend you to store these modules in the packaged state when they were shipped from Midas. At that time, be careful not to let water drops adhere to the packages or bags.)
- (2) When the OLED display module is being dewed or when it is placed under high temperature or high humidity environments, the electrodes may be corroded if electric current is applied. Please store it in clean environment.

3. Designing Precautions

- (1) The absolute maximum ratings are the ratings which cannot be exceeded for OLED display module, and if these values are exceeded, OLED display module may be damaged.
- (2) To prevent occurrence of malfunctioning by noise, pay attention to satisfy the VIL and VIH specification and to make the signal line cable as short as possible.
- (3) We recommend you to install excess current preventive unit (fuses, etc.) to the power circuit (VDD / VCC). (Recommend value: 0.5A)
- (4) Pay sufficient attention to avoid occurrence of mutual noise interference with the nearby devices.
- (5) As for EMI, take necessary measures on the equipment side basically.
- (6) If the power supplied to the OLED display module is forcibly shut down by such errors as taking out the main battery while the OLED display panel is in operation, we cannot guarantee the quality of this OLED display module.
 - * Connection (contact) to any other potential than the above may lead to rupture of the IC.
- (7) If this OLED driver is exposed to light, malfunctioning may occur and semiconductor elements may change their characteristics.



- (8) The internal status may be changed, if excessive external noise enters into the module. Therefore, it is necessary to take appropriate measures to suppress noise generation or to protect module from influences of noise on the system design.
- (9) We recommend you to make periodical refreshment of the operation statuses (re-setting of the commands and re-transference of the display data) to cope with catastrophic noise.
- (10) It's pretty common to use "Screen Saver" to extend the lifetime and Don't use the same image for long time in real application. When an OLED display module is operated for a long of time with fixed pattern, an afterimage or slight contrast deviation may occur.
- (11) The limitation of FPC and Film bending.

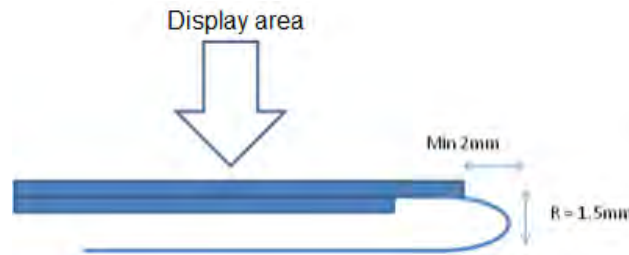

- (12) The module should be fixed balanced into the housing, or the module may be twisted.

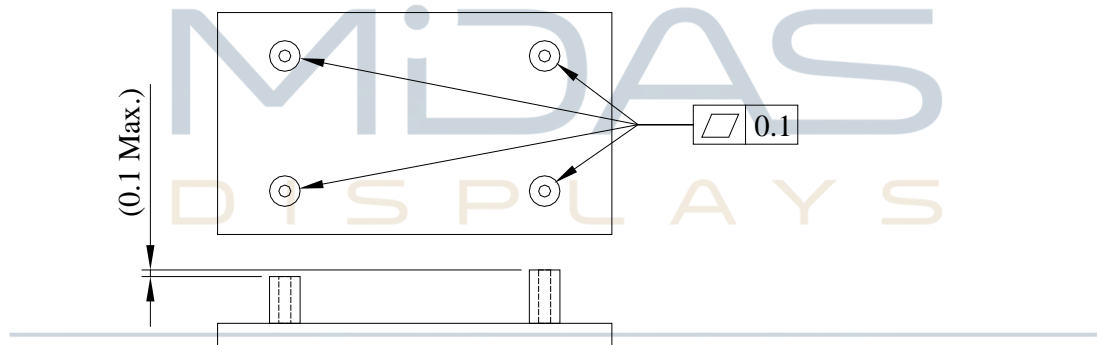

- (13) Please heat up a little the tape sticking on the components when removing it; otherwise the components might be damaged.

4. Precautions when disposing of the OLED display modules

- (1) Request the qualified companies to handle industrial wastes when disposing of the OLED display modules. Or, when burning them, be sure to observe the environmental and hygienic laws and regulations.

