

High precision fluxgate AC/DC current transducer for galvanically isolated measurement up to 1000 A

**Features**

- 600 A rms nominal current
- 1500:1 primary/secondary current ratio
- Current output through D-sub-9 connector
- Ø28.1 mm aperture
- 9 ppm total accuracy
- 1 ppm linearity
- 7 ppm offset
- Status signal and LED



**Description**

High precision DC current transducer (DCCT) measuring up to 1000 A currents and continuously measuring 900 A currents with a linearity error less than 1 ppm.

Based on the ultra stable Danisense closed loop flux gate technology, the DQ600ID has very low offset and ultra low drift.

It provides high resolution for precise monitoring, reliable and consistent performance, and a rugged design for durability.

**Applications**

- Electric vehicle (EV) test bench
- Power measurement and power analysis
- Particle accelerators
- MRI devices and medical scanners
- Battery testing and evaluation systems
- Current calibration purposes
- Stable power supplies
- Precision current sensing

## Electrical specifications at 23 °C, $V_S = \pm 15$ V supply voltage

Parameter		Symbol	Unit	Min	Typ.	Max	Comment
Nominal primary AC current	Continuous	$I_{PN\ AC}$	Arms			600	See Fig. 3 for details
Nominal primary DC current	Continuous	$I_{PN\ DC}$	A	-900		900	For other values see Fig. 2
Measuring range		$I_{PM}$	A	-1000		1000	See Fig. 2 & Fig. 3 for details
Overload capacity	Peak	$I_{OL}$	A			4500	Single pulse 100ms
Nominal secondary current	Continuous	$I_{SN}$	mA	-600		600	At nominal primary DC current
Primary / secondary ratio				1500		1500	$I_{primary}/I_{secondary}$
Measuring resistance		$R_M$	$\Omega$	0	3		See Fig. 2 for details
Linearity error		$\epsilon_L$	ppm	-1		1	ppm refers to reading
Offset current (including earth field)		$I_{OE}$	ppm	-7		7	ppm refers to $I_{PN\ DC}$
Offset temperature coefficient		$TC_{IOE}$	ppm/K	-0.1		0.1	ppm refers to $I_{PN\ DC}$
Offset stability over time			ppm/month	-0.1		0.1	ppm refers to $I_{PN\ DC}$
Bandwidth		$f(\pm 3dB)$	kHz		450		Small signal. See Fig. 4
Response time to a step current $I_{PN}$		$t_r$	$\mu s$		1		To 90% of step current
Total accuracy without offset		$\epsilon_{tot}$		% of reading + % of full scale			Full scale refers to $I_{PN\ DC}$ .
	<10 Hz			0.0002 + 0.00001			For details, see <a href="#">Reading and full scale</a>
	<100 Hz			0.0004 + 0.00002			
	<1 kHz			0.01 + 0.00003			For other frequencies, see <a href="#">Linear interpolation of accuracy specification</a> .
	<10 kHz			0.05 + 0.0001			
	<100 kHz			2.5 + 0.001			
	<300 kHz			15 + 0.003			
Phase shift	<10 Hz			0.01°			
	<100 Hz			0.01°			
	<1 kHz			0.02°			
	<10 kHz			0.25°			
	<100 kHz			1°			
	<300 kHz			10°			
RMS noise	<10 Hz		ppm rms			0.01	ppm refers to $I_{PN\ DC}$
	<100 Hz					0.03	
	<1 kHz					0.05	
	<10 kHz					0.1	
	<100 kHz					2	
Peak-to-peak noise	<10 Hz		ppm p-p			0.05	ppm refers to $I_{PN\ DC}$
	<100 Hz					0.15	
	<1 kHz					0.25	
	<10 kHz					0.5	
	<100 kHz					10	
Fluxgate excitation frequency		$f_{exc}$	kHz		31.25		
Power supply voltages		$V_S$	V	$\pm 14.25$		$\pm 15.75$	
Idle current consumption			mA		$\pm 100$		Primary current = 0 A
Current consumption at nominal current			mA	-700		700	At $I_{PN\ DC}$
Current consumption at max current			mA	-770		770	At $I_{PM}$
Operating temperature range		$T_a$	°C	-40		85	See Fig. 3
Offset change with external magnetic field			ppm/mT		$\pm 3.5$		ppm refers to nominal current
Offset change with power supply voltage changes			ppm/V	-0.3		0.3	ppm refers to nominal current

1 ppm nominal = 0.6  $\mu A$  secondary current.

### Linearity error

Linearity error is defined as the deviation from a straight line. The straight line is a linear regression trend line based on the least squares method of the measurement points from 0 to positive max current and another trendline is calculated from 0 to negative max current. The difference between each measured point and the linear trend line is the linearity error. The linearity error  $\epsilon_L$  can be expressed as (1), where  $I_{\text{reading}}$  is the measurement result and  $I_{\text{fitted}}$  is the regression value.

$$\epsilon_L = I_{\text{reading}} - I_{\text{fitted}} \quad (1)$$

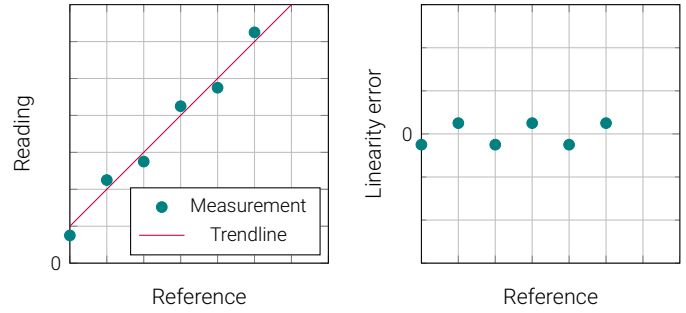

Figure 1: Linearity error definition

### Reading and full scale

Reading is the actual value measured at a given time. Full scale is the rated nominal value of the device. If a given current  $I_{\text{reading}}$  is measured, the total accuracy is calculated as (2). Example: A 500 A rated device has a specification of 0.005% + 0.0015% (reading + full scale) at < 10 Hz, plus an offset of 0.001% (of full scale). The device is measuring (reading) 10 A dc, and the accuracy is calculated as (3).

$$\epsilon_{\text{tot}} = \epsilon_{\text{reading}} \cdot I_{\text{reading}} + (\epsilon_{\text{fullscale}} + \epsilon_{\text{offset}}) \cdot I_{\text{PNDC}} \quad (2)$$

$$\epsilon_{\text{tot}} = 0.005\% \cdot 10\text{A} + (0.0015\% + 0.001\%) \cdot 500\text{A} = 13\text{mA} \quad (3)$$

### Primary and secondary current/voltage

The secondary current  $I_S$  or voltage  $V_S$  is calculated by using the transfer ratio  $k$ , as in (4).

$$I_S = \frac{I_P}{k}, \quad V_S = \frac{V_P}{k} \quad (4)$$

### Converting from ppm of nominal to secondary current/voltage

The nominal primary current is the rated current for the device. If  $\epsilon_{\text{ppm}}$  is the error in ppm referred to nominal, use (5) to convert to ampere primary current. If the primary/secondary transfer ratio is  $k$ , use (6) to convert to ampere secondary current. If the device has voltage output, use (7)

$$\epsilon_{\text{Pampere}} = \epsilon_{\text{ppm}} \cdot I_{\text{PNDC}} \cdot 1 \times 10^{-6} \quad (5)$$

$$\epsilon_{\text{Sampere}} = \epsilon_{\text{ppm}} \cdot \frac{I_{\text{PNDC}}}{k} \cdot 1 \times 10^{-6} \quad (6)$$

$$\epsilon_{\text{Svolt}} = \epsilon_{\text{ppm}} \cdot \frac{V_{\text{PNDC}}}{k} \cdot 1 \times 10^{-6} \quad (7)$$

### Linear interpolation of accuracy specification

If the accuracy at a specific frequency is required, it is possible to use linear interpolation between known points. If the frequency  $f$  is  $f_1 < f < f_2$  and the accuracy at the frequency  $\epsilon(f)$  is  $\epsilon(f_1) < \epsilon(f) < \epsilon(f_2)$ , then the accuracy at  $f$  is found as (8).

$$\epsilon(f) = \frac{\epsilon(f_2) - \epsilon(f_1)}{f_2 - f_1} (f - f_1) + \epsilon(f_1) \quad (8)$$

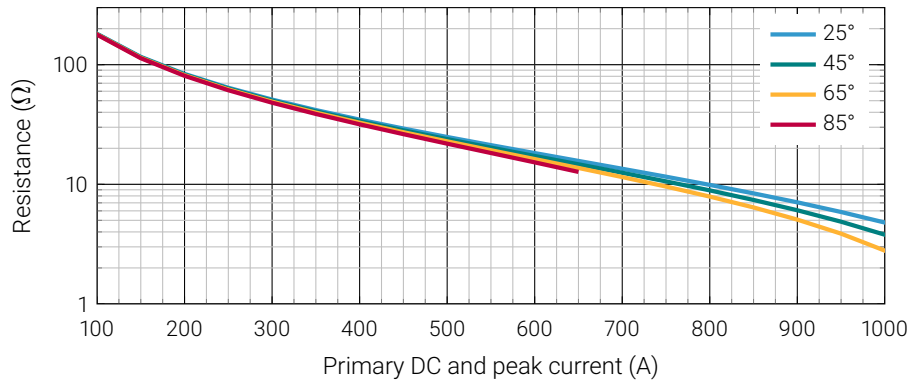

Figure 2: Maximum measurement resistor  $R_M$  vs. ambient temperatures

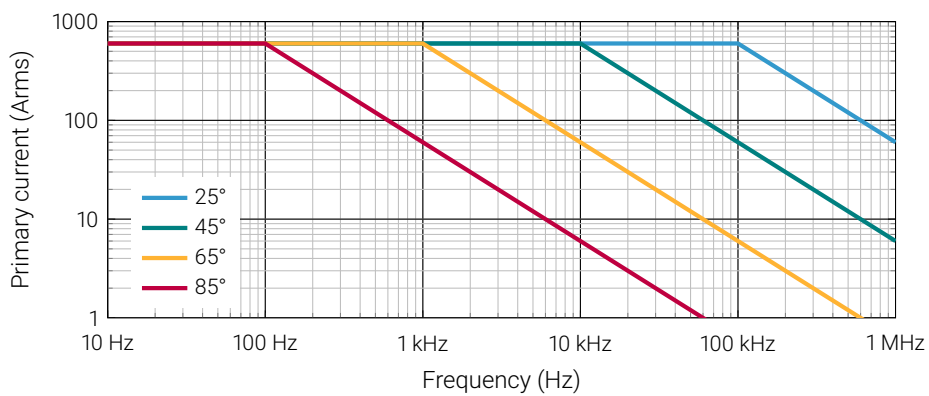

Figure 3: Maximum continuous primary current vs. frequency

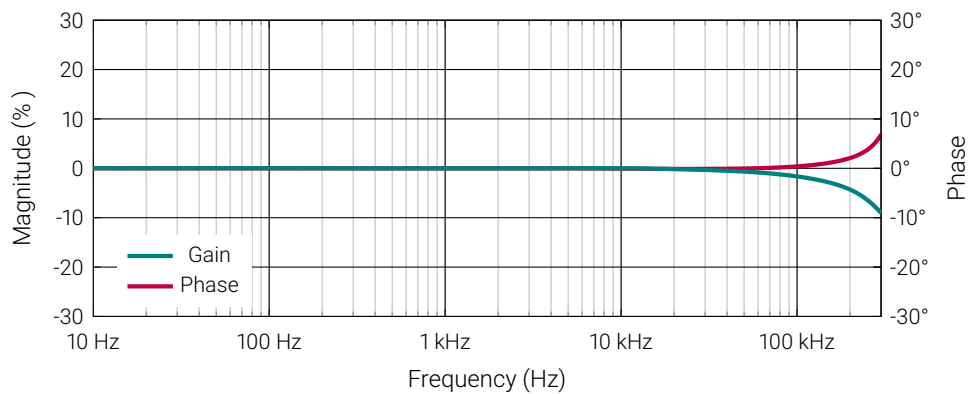

Figure 4: Frequency characteristics

## Isolation specifications according to IEC 61010-1



When using *REINFORCED insulated* wire, all wiring must be insulated for the highest voltage used. When using *BASIC insulated* or *uninsulated* wire, follow the specified voltages in the table below:

Parameter	Unit	Value
Clearance	mm	9.5
Creepage distance	mm	10.5
Comparative tracking index (CTI)	V	> 600
Continuous working voltage according to IEC 61010-1 with:		
<i>Uninsulated</i> wire:		
Non mains		1000
CAT II (dc and rms)		600
CAT III (dc and rms)		300
<i>BASIC insulated</i> wire:	V	
Non mains		2000
CAT II (dc and rms)		1000
CAT III (dc and rms)		1000
Transient voltage according to IEC 61010-1 with:		
<i>Uninsulated</i> wire:		
Non mains		4500
CAT II		6000
CAT III		6000
<i>BASIC insulated</i> wire:	V	
Non mains		6500
CAT II		6000
CAT III		8000



Do not connect the transducer to signals or use for measurements within Measurement Category IV, or for measurements on MAINS circuits or on circuits derived from Overvoltage Category IV which may have transient overvoltages above what the product can withstand. The product must not be connected to circuits that have a maximum voltage above the continuous working voltage, relative to earth or to other channels, or this could damage and defeat the insulation.

## Environmental and mechanical characteristics

Parameter	Unit	Min	Typ	Max	Comment
Altitude	m			2000	
Usage					Designed for indoor use
Pollution degree				2	
Operating temperature range	°C	-40		85	
Storage temperature range	°C	-40		85	
Relative humidity	%	20		80	Non-condensing
Ingress protection rating				IP20	
Mass	kg		0.6		

Connections: D-sub-9  
 EMC: EN 61326-1:2013-2021  
 Safety: IEC 61010-2-030:2021/A11:2021 and IEC 61010-1:2010/A1:2019

External devices:	External devices connected to current transducers must comply with the standards IEC61010-1 and IEC62368-1 and be energy-limited circuitry
Cleaning:	The transducer should only be cleaned with a damp cloth. No detergent or chemicals should be used.
Temperature:	When multiple primary turns are used or high primary currents are applied the temperature around the transducer will increase, please monitor to ensure that the maximum ratings are not exceeded. It is recommended to have minimum 1 mm <sup>2</sup> per ampere in the primary bus bar.

## Intended use

The DQ600ID is designed to measure current up to 1000 A, and be powered by a DSSIU-4-1U or DSSIU-6-1U or similar power supplies. Please see the product manual: <https://danisense.com/user-manual>.

## Instruction for use

 Please follow the polarity of the voltage supply to avoid damaging the device. See Fig. 7.

1. Do not power up the device before all cables are connected.
2. Place the primary conductor through the aperture of the transducer.
3. Connect a D-sub-9 cable between DSSIU-4/6-1U and each sensor.
4. Connect a low impedance amperemeter, measuring resistor or power analyzer on the secondary output (4mm red and black connectors on the DSSIU-4/6-1U).
5. When all connection are secured - connect mains power.
6. Apply primary current.

 There is a risk of electrical shock if an uninsulated busbar with high voltages is touching the metal enclosure of the transducer. Please ensure, before powering up the system, that no uninsulated wire can touch the metal enclosure.

## Advanced Sensor Protection Circuits "ASPC"

Developed to protect the current transducer from typical fault conditions:

- Unit is un-powered and secondary circuit is open or closed
- Unit is powered and secondary circuit is open or interrupted

Both DC and AC primary current up to 100% of nominal value can be applied to the current transducers in the above situations without damage to the electronics. Please notice that the transducer core can be magnetized in all above cases, leading to a small change in output offset current (less than 10ppm)

 Do not disassemble the unit. If the green status LED is not operating with all cables connected and the system powered up, disconnect power and contact Danisense for further instruction. If the equipment is used in a manner not specified by the manufacturer, the protection provided by the equipment may be impaired.

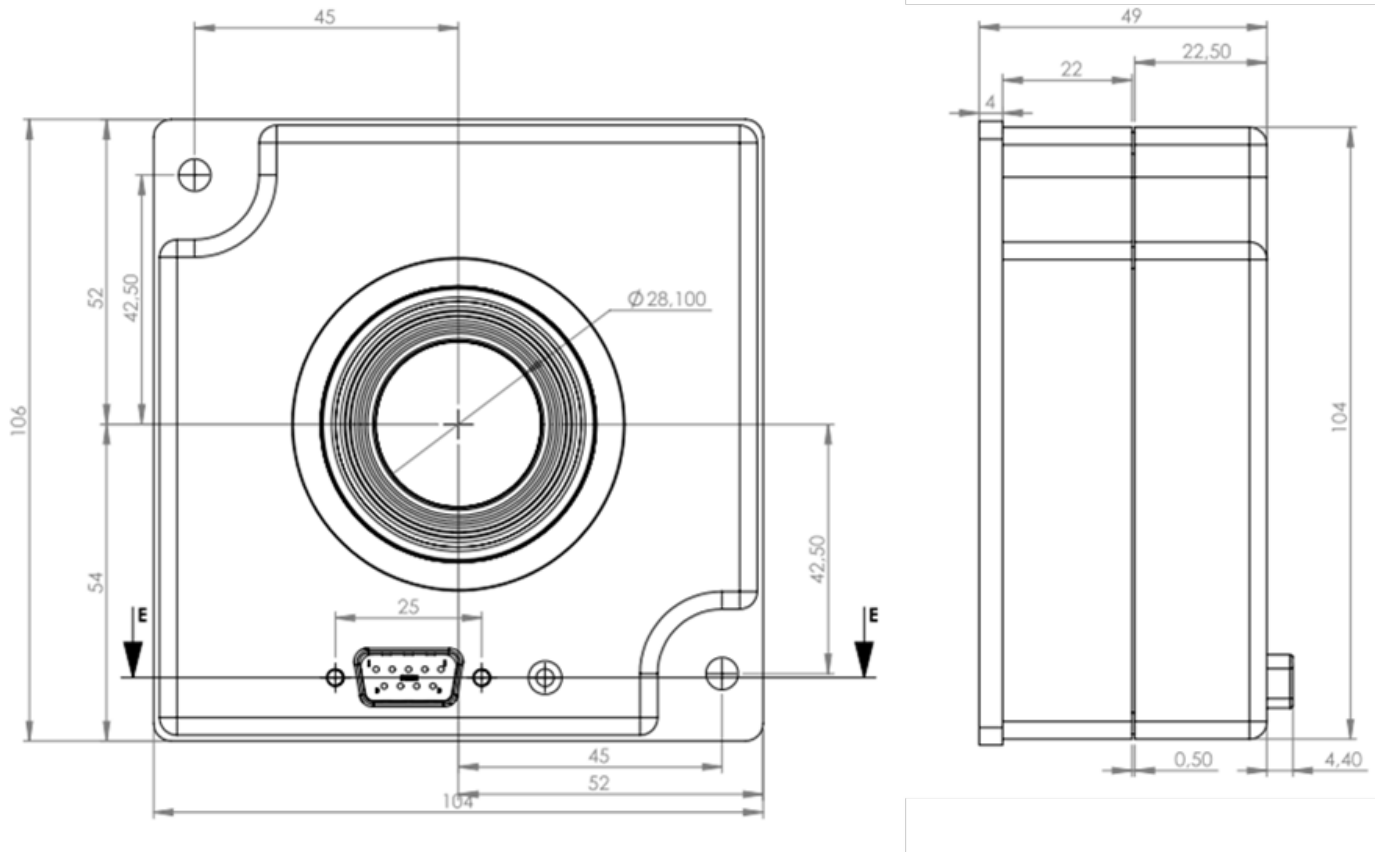

Figure 5: Dimensions of sensor head. Tolerance is 0.3 mm

**Mounting**

Back side: 2 x 5.2 mm holes

**Positive current direction**

Is identified by an arrow on the back side isolation plastic insert.

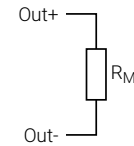

Figure 6: External measurement resistor connection, see

Fig. 2

**Pin out description**

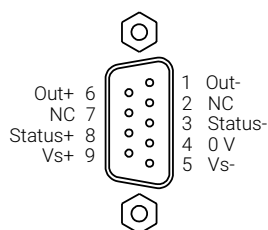

Figure 7: D-sub-9 connection pinout

- 1 Out- Measurement output negative terminal
- 2 NC No connection
- 3 Status- Status signal negative terminal
- 4 0 V 0 V connection for supply voltage
- 5 Vs- Negative supply voltage
- 6 Out+ Measurement output positive terminal
- 7 NC No connection
- 8 Status+ Status signal positive terminal
- 9 Vs+ Positive supply voltage

Status signal and LED

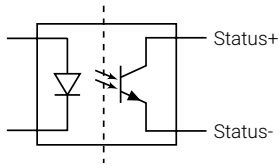

Figure 8: Status signal optocoupler

When the sensor is operating in normal condition the status pins (Status+ and Status-) are shorted by an optocoupler and the green status LED is ON, see Fig. 8. When a fault is detected, or the power is off, the status pins are opened and the green status LED is OFF. Status signal optocoupler ratings found below:

Forward direction:	Status+ to Status- (Pin 8 to pin 3)
Maximum forward current:	10 mA
Maximum forward voltage:	60 V
Maximum reverse voltage:	5 V

# Declaration of Conformity

Danisense A/S  
Malervej 10  
DK-2630 Taastrup  
Denmark

Declares that under our sole responsibility that this product is in conformity with the provisions of the following EC Directives, including all amendments, and with national legislation implementing these directives:

Directive 2014/30/EU

Directive 2014/35/EU

And that the following harmonized standards have been applied

EEN 61010-1 (Third Edition):2010, EN 61010-1:2010/A1:2019

EN 61010-2-030:2021/A11:2021

EN 61326-1:2013

All DANISENSE products are manufactured in accordance with RoHS directive 2011/65/EU. Annex II of the RoHS directive was amended by directive 2015/863 in force since 2015, expanding the list of 6 restricted substances (Lead, Hexavalent Chromium, PBB, PBDE and Cadmium)

Danisense follows the provision in EN 63000:2018



Place  
Taastrup, Denmark

Henrik Elbæk

Date  
2022-03-15